



Body Camera

Quick Start Guide



Legal Information

©2020 Hangzhou Hikvision Digital Technology Co., Ltd. All rights reserved.

About this Manual

The Manual includes instructions for using and managing the Product. Pictures, charts, images and all other information hereinafter are for description and explanation only. The information contained in the Manual is subject to change, without notice, due to firmware updates or other reasons. Please find the latest version of this Manual at the Hikvision website (<https://www.hikvision.com/>).

Please use this Manual with the guidance and assistance of professionals trained in supporting the Product.

Trademarks

HIKVISION and other Hikvision's trademarks and logos are the properties of Hikvision in various jurisdictions. Other trademarks and logos mentioned are the properties of their respective owners.

Disclaimer

TO THE MAXIMUM EXTENT PERMITTED BY APPLICABLE LAW, THIS MANUAL AND THE PRODUCT DESCRIBED, WITH ITS HARDWARE, SOFTWARE AND FIRMWARE, ARE PROVIDED "AS IS" AND "WITH ALL FAULTS AND ERRORS". HIKVISION MAKES NO WARRANTIES, EXPRESS OR IMPLIED, INCLUDING WITHOUT LIMITATION, MERCHANTABILITY, SATISFACTORY QUALITY, OR FITNESS FOR A PARTICULAR PURPOSE. THE USE OF THE PRODUCT BY YOU IS AT YOUR OWN RISK. IN NO EVENT WILL HIKVISION BE LIABLE TO YOU FOR ANY SPECIAL, CONSEQUENTIAL, INCIDENTAL, OR INDIRECT DAMAGES, INCLUDING, AMONG OTHERS, DAMAGES FOR LOSS OF BUSINESS PROFITS, BUSINESS INTERRUPTION, OR LOSS OF DATA, CORRUPTION OF SYSTEMS, OR LOSS OF DOCUMENTATION, WHETHER BASED ON BREACH OF CONTRACT, TORT (INCLUDING NEGLIGENCE), PRODUCT LIABILITY, OR OTHERWISE, IN CONNECTION WITH THE USE OF THE PRODUCT, EVEN IF HIKVISION HAS BEEN ADVISED OF THE POSSIBILITY OF SUCH DAMAGES OR LOSS.

YOU ACKNOWLEDGE THAT THE NATURE OF INTERNET PROVIDES FOR INHERENT SECURITY RISKS, AND HIKVISION SHALL NOT TAKE ANY RESPONSIBILITIES FOR ABNORMAL OPERATION, PRIVACY LEAKAGE OR OTHER DAMAGES RESULTING FROM CYBER-ATTACK, HACKER ATTACK, VIRUS INSPECTION, OR OTHER INTERNET SECURITY RISKS; HOWEVER, HIKVISION WILL PROVIDE TIMELY TECHNICAL SUPPORT IF REQUIRED.

YOU AGREE TO USE THIS PRODUCT IN COMPLIANCE WITH ALL APPLICABLE LAWS, AND YOU ARE SOLELY RESPONSIBLE FOR ENSURING THAT YOUR USE CONFORMS TO THE APPLICABLE LAW. ESPECIALLY, YOU ARE RESPONSIBLE, FOR USING THIS PRODUCT IN A MANNER THAT DOES NOT INFRINGE ON THE RIGHTS OF THIRD PARTIES, INCLUDING WITHOUT LIMITATION, RIGHTS OF

PUBLICITY, INTELLECTUAL PROPERTY RIGHTS, OR DATA PROTECTION AND OTHER PRIVACY RIGHTS. YOU SHALL NOT USE THIS PRODUCT FOR ANY PROHIBITED END-USES, INCLUDING THE DEVELOPMENT OR PRODUCTION OF WEAPONS OF MASS DESTRUCTION, THE DEVELOPMENT OR PRODUCTION OF CHEMICAL OR BIOLOGICAL WEAPONS, ANY ACTIVITIES IN THE CONTEXT RELATED TO ANY NUCLEAR EXPLOSIVE OR UNSAFE NUCLEAR FUEL-CYCLE, OR IN SUPPORT OF HUMAN RIGHTS ABUSES.

IN THE EVENT OF ANY CONFLICTS BETWEEN THIS MANUAL AND THE APPLICABLE LAW, THE LATER PREVAILS.

Regulatory Information

FCC Information

Please take attention that changes or modification not expressly approved by the party responsible for compliance could void the user's authority to operate the equipment.

FCC compliance: Please take attention that changes or modification not expressly approved by the party responsible for compliance could void the user's authority to operate the equipment.

Note: This product has been tested and found to comply with the limits for a Class B digital device, pursuant to Part 15 of the FCC Rules. These limits are designed to provide reasonable protection against harmful interference in a residential installation. This product generates, uses, and can radiate radio frequency energy and, if not installed and used in accordance with the instructions, may cause harmful interference to radio communications. However, there is no guarantee that interference will not occur in a particular installation. If this product does cause harmful interference to radio or television reception, which can be determined by turning the equipment off and on, the user is encouraged to try to correct the interference by one or more of the following measures:

- Reorient or relocate the receiving antenna.
- Increase the separation between the equipment and receiver.
- Connect the equipment into an outlet on a circuit different from that to which the receiver is connected.
- Consult the dealer or an experienced radio/TV technician for help.

FCC Conditions

This device complies with part 15 of the FCC Rules. Operation is subject to the following two conditions:

1. This device may not cause harmful interference.
2. This device must accept any interference received, including interference that may cause undesired operation.

EU Conformity Statement



This product and - if applicable - the supplied accessories too are marked with "CE" and comply therefore with the applicable harmonized European standards listed under the EMC Directive 2014/30/EU, the LVD Directive 2014/35/EU, the RoHS Directive 2011/65/EU.



2012/19/EU (WEEE directive): Products marked with this symbol cannot be disposed of as unsorted municipal waste in the European Union. For proper recycling, return this product to your local supplier upon the purchase of equivalent new equipment, or dispose of it at designated collection points. For more information see: www.recyclethis.info



2006/66/EC (battery directive): This product contains a battery that cannot be disposed of as unsorted municipal waste in the European Union. See the product documentation for specific

battery information. The battery is marked with this symbol, which may include lettering to indicate cadmium (Cd), lead (Pb), or mercury (Hg). For proper recycling, return the battery to your supplier or to a designated collection point. For more information see: www.recyclethis.info

Industry Canada ICES-003 Compliance

This device meets the CAN ICES-3 (B)/NMB-3(B) standards requirements.

This device complies with Industry Canada licence-exempt RSS standard(s). Operation is subject to the following two conditions:

1. this device may not cause interference, and
2. this device must accept any interference, including interference that may cause undesired operation of the device.

Le présent appareil est conforme aux CNR d'Industrie Canada applicables aux appareils radioexempts de licence. L'exploitation est autorisée aux deux conditions suivantes:

1. l'appareil ne doit pas produire de brouillage, et
2. l'utilisateur de l'appareil doit accepter tout brouillage radioélectrique subi, même si le brouillage est susceptible d'en compromettre le fonctionnement.

Under Industry Canada regulations, this radio transmitter may only operate using an antenna of a type and maximum (or lesser) gain approved for the transmitter by Industry Canada. To reduce potential radio interference to other users, the antenna type and its gain should be so chosen that the equivalent isotropically radiated power (e.i.r.p.) is not more than that necessary for successful communication.

Conformément à la réglementation d'Industrie Canada, le présent émetteur radio peut fonctionner avec une antenne d'un type et d'un gain maximal (ou inférieur) approuvé pour l'émetteur par Industrie Canada. Dans le but de réduire les risques de brouillage radioélectrique à l'intention des autres utilisateurs, il faut choisir le type d'antenne et son gain de sorte que la puissance isotrope rayonnée équivalente (p.i.r.e.) ne dépasse pas l'intensité nécessaire à l'établissement d'une communication satisfaisante.



Manual Acquisition

Scan the QR code for the user manual of the body camera.



Symbol Conventions

The symbols that may be found in this document are defined as follows.

Symbol	Description
 Danger	Indicates a hazardous situation which, if not avoided, will or could result in death or serious injury.
 Caution	Indicates a potentially hazardous situation which, if not avoided, could result in equipment damage, data loss, performance degradation, or unexpected results.
 Note	Provides additional information to emphasize or supplement important points of the main text.

Safety Instruction

Laws and Regulations

Use of the product must be in strict compliance with the local laws and regulations. Please shut down the device in prohibited area.

Power Supply

- Use of the product must be in strict compliance with the local electrical safety regulations.
- Use the power adapter provided by qualified manufacturer. Refer to the product specification for detailed power requirements.
- It is recommended to provide independent power adapter for each device as adapter overload may cause over-heating or a fire hazard.
- Make sure that the power has been disconnected before you wire, install, or disassemble the device.
- DO NOT directly touch exposed contacts and components once the device is powered up to avoid electric shock.
- DO NOT use damaged power supply devices (e.g., cable, power adapter, etc.) to avoid electric shock, fire hazard, and explosion.
- DO NOT directly cut the power supply to shut down the device. Please shut down the device normally and then unplug the power cord to avoid data loss.
- DO NOT block the power supply equipment to plug and unplug conveniently.
- Make sure the power supply has been disconnected if the power adapter is idle.
- Make sure the device is connected to the ground firmly.

Transportation, Use, and Storage

- To avoid heat accumulation, good ventilation is required for a proper operating environment.
- Store the device in dry, well-ventilated, corrosive-gas-free, no direct sunlight, and no heating source environment.
- Avoid fire, water, and explosive environment when using the device.
- Avoid lightning strike for device installation. Install a lightning arrester if necessary.
- Keep the device away from magnetic interference.
- Avoid device installation on vibratory surface or places, and avoid equipment installation on vibratory surface or places subject to shock (ignorance may cause device damage).
- DO NOT touch the heat dissipation component to avoid burns.

- DO NOT expose the device to extremely hot, cold, or humidity environments. For temperature and humidity requirements, see device specification.
- The device can only be safely used in the region below 2000 meters above the sea level.

Maintenance

- If smoke, odor, or noise arises from the device, immediately turn off the power, unplug the power cable, and contact the service center.
- If the device is abnormal, contact the store you purchased it or the nearest service center. DO NOT disassemble or modify the device in any way (For the problems caused by unauthorized modification or maintenance, the company shall not take any responsibility).
- Keep all wrappers after unpacking them for future use. In case of any failure occurred, you need to return the device to the factory with the original wrapper. Transportation without the original wrapper may result in damage to the device and the company shall not take any responsibility.

Network

- Please enforce the protection for the personal information and the data security as the device may be confronted with the network security problems when it is connected to the Internet. Please contact us when the device might exist network security risks.
- Please understand that you have the responsibility to configure all the passwords and other security settings about the device, and keep your user name and password.

Lens

- DO NOT touch the lens with fingers directly in case the acidic sweat of the fingers erodes the surface coating of the lens.
- DO NOT aim the lens at the strong light such as sun or incandescent lamp. The strong light can cause fatal damage to the device.

Screen

Clean the screen with soft and dry cloth or other substitutes to wipe the interior and exterior surface. DO NOT use alkaline detergents. Protect the screen from scratches.

Battery

- DO NOT charge the battery continuously more than one week. Overcharging may shorten the battery life.
- Battery will discharge gradually if it is not used for a long time. It must be recharged before using.
- If the device contains dismantlable battery, store the device and battery separately if it is not used.

- The battery must be charged and discharged every three months if it is not used, and recharged to 60% to 70% power percentage to store.
- The scrapped battery should be discarded in compliance with the local laws and regulations. If there are no corresponding laws or regulations, throw it in a hazardous trash can.
- DO NOT pierce the battery or shorten the electrodes, or it may cause explosion or fire hazard.
- DO NOT throw the battery in fire or water, or it may cause explosion.
- Please use the specific battery supported by the device, or it may cause explosion. If the battery is damaged and needs to be changed, contact the device manufacturer or local distributor.
- If the device contains button battery, keep it far away from children.
- DO NOT expose the battery pack or battery combination to sunlight, fire, or similar overheated environment.

Data

DO NOT disconnect the power during formatting, uploading, and downloading. Or files may be damaged.

Laser

The laser radiation emitted from the device can cause eye injuries, burning of skin or inflammable substances. Before enabling the Light Supplement function, make sure no human or inflammable substances are in front of the laser lens.

1 Product Introduction

1.1 Introduction

Body camera (hereinafter referred to as device) highly integrates with record, taping, capture, positioning, etc. It is embedded with positioning module with high sensitivity to locate the occurring position of events accurately. It can record the process and condition of events completely via record, taping, and capture. You can also tag the important data for future search.

It is small and light, convenient to carry, and can be worn on the shoulder, satisfying the requirement of mobile duty and evidence record for single person. It is widely applicable to public security protection, city management, industry and commerce, etc.

1.2 Key Feature

- HD recording.
- The recorded videos can be uploaded to the central video platform via 4G wireless communication.
- Dual positioning modules of GPS and Beidou. The location information can be uploaded to the command center in real time.
- Supports IR night vision. Even in the dark scene, the facial features of the persons in the scene can be recognized clearly.
- Tri-proof design to support all-weather filed operation.
- Built-in battery with large capacity, supporting longer working hour.
- Small size, light weight, and convenient to carry.
- Large recording button for convenient operation.

1.3 Packing List

Following objects are included in package. If something loses, contact us or our supplier.

Table 1-1 Packing List

No.	Name	Quantity
1	Body camera	1
2	Shoulder Clip	1
3	USB data cable	1
4	Charger	1
5	Quick start guide	1

1.4 Appearance

Refer to the figure and table below for the appearance of the device.

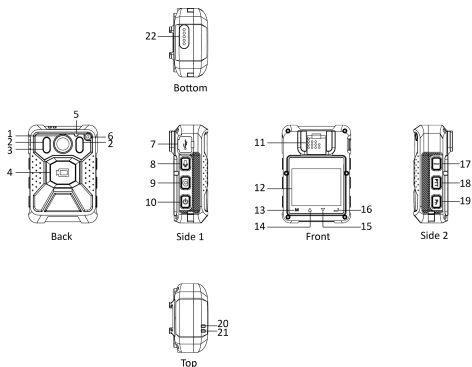





Figure 1-1 Appearance

Table 1-2 Appearance Description

No.	Name	Description
1	Lens	For recording and capture.
2	IR lights	<ul style="list-style-type: none"> •If you set IR as ON, the IR lights will be enabled during recording. •If you set IR as AUTO, the IR lights will be enabled automatically during recording or remote live view when the illumination is insufficient.
3	LED light	<p>After the device starts up, hold tapping button to turn on LED light for light supplement or emergency illumination. Then hold it again to turn off LED light.</p> <p> Note</p> <p>If you turn on LED light while IR function is enabled already, the IR function will be disabled forcedly. After you turn off LED light, the IR function will restore to be enabled.</p>
4	Record	<ul style="list-style-type: none"> •After the device starts up, press it to start record. Then press it again to stop record. •When the device is shut down, hold it to start it up and start recording.

No.	Name	Description
5	MIC	For voice collection.
6	Laser light	After the device starts up, hold the recording button to enable laser light which can point to the center of the image. Then hold it again to disable laser light.
7	Mini USB interface and 3G/4G SIM card slot plug	Open the plug to connect to data cable or insert 3G/4G SIM card.
8	Tape	After the device starts up, press it to start taping. Then press it again to stop taping.
9	Capture	After the device starts up, press it once to capture a picture.
10	On/Off	<ul style="list-style-type: none"> •When the device is off, hold it to start it up. •When the device is on, hold it to shut it down. •After the device starts up, press it to inactivate/activate the screen display.
11	Loudspeaker	For sound play.
12	LCD	For local menu display and operation.
13	M	<ul style="list-style-type: none"> •In live view mode, tap it to enter the main menu. •In menu or configuration mode, tap it to exit.
14/15	△/▽	<ul style="list-style-type: none"> •In menu, configuration, and input mode, tap it to navigate between menus, items, and fields. •In video playback mode, tap △/▽ to speed up/slow down the playback speed. •In live view mode, tap △/▽ to zoom in/out.

No.	Name	Description
16		In menu, configuration, and input mode, tap it to enter the sub-menu, and confirm the selection or entered content.
17	Alarm	After the device starts up, hold it to send the alarm signal to the connected platform manually.
18	PTT	After the device starts up, hold it to set the device as a MIC or loudspeaker to start two-way audio.
19	Fn	<p>During record, press it to set a tag for the current video. Then hold it to cancel the tag.</p> <p> Note</p> <p>Tagging only takes effect with the current record. When the record ends, tagging stops.</p>
20	LED 1	<ul style="list-style-type: none"> •Solid red: The device is being charged. •Solid green: The device is fully charged. •Flashing red (high frequency): The device is in low battery. •Flashing red (low frequency): The device is recording.
21	LED 2	<ul style="list-style-type: none"> •Solid green: The device is running. •Flashing yellow (low frequency): The device is taping.
22	Expansion interface	Reserved.

2 Installation

2.1 Install Shoulder Clip

Install the shoulder clip if you want to wear the device on your shoulder.

Steps

1. Parallel the sheet metal buckle of the shoulder clip with the shoulder clip slot on the front panel of the device, and insert the shoulder clip into the slot as the direction shown below.

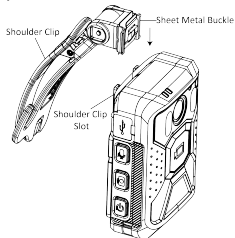

Figure 2-1 Install Shoulder Clip

2. Push the shoulder clip downward until it is installed firmly.
3. **Optional:** Hold the shoulder clip, and squeeze the spring strip outward. Slide the shoulder clip upward to uninstall it.

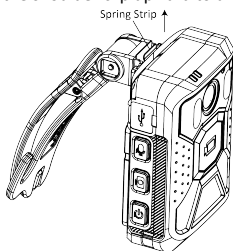

Figure 2-2 Uninstall Shoulder Clip

2.2 Install 3G/4G SIM Card

Install 3G/4G SIM card if you want to connect to network via 3G/4G SIM card.

Before You Start

Prepare the 3G/4G SIM card.

Steps

Note

The 3G/4G SIM card should be nano-SIM card.

1. Open the card slot plug on the side of the device.
2. Insert the 3G/4G SIM card into the card slot with the latched angle facing inward and downward until it is installed firmly.

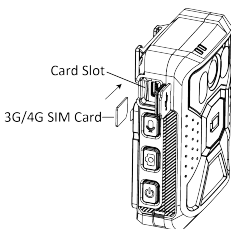

Figure 2-3 Install 3G/4G SIM Card

3. Close the card slot plug.

2.3 Charge

When the device is in low battery, charge it in time.

Steps

1. Open the mini USB interface plug on the side of the device.
2. Connect one end of the USB data cable to the device, and the other end to the charger to charge the device.

2.4 Install Body Camera Assistant

Install Body Camera Assistant (hereinafter referred to as software) if you want to configure the device parameters, download files, etc. via the computer. You can get the software from the official website (www.hikvision.com).

Steps

Note

Install "BodyCameraAssistant-win32.exe" if your computer is in 32-bit operating system. Install "BodyCameraAssistant-win64.exe" if your computer is in 64-bit operating system.

-
1. Get the installation file, and double click it.
 2. Select the software saving path, and click **Next**.

Note

The software is installed in C disk by default. You can click **Browse** to change the saving path.

-
3. Click **Next**.
 4. Check **Create a desktop icon** according to your needs, and click **Next**.
 5. Click **Install**.
 6. Click **Next** to install the software drive.
 7. Click **Finish**.
 8. Click **Finish** to run the software.

3 Basic Operation

3.1 Startup

When the device is off, hold  on the device side to start it up. Refer to the user manual for the startup page description.

3.2 Storage

The recorded video, taped audio, and captured picture will be stored in the device.

3.2.1 Record

You can record video via the device.

Steps

1. Press  (recording button) to start record.
 - Press the recording button in the sleeping mode. The screen will not be woken up if the voice prompt is enabled, or the LED indicators are enabled, or voice prompt and LED indicators are enabled at the same time. If only LED indicators are enabled, LED 1 will flash in red in low frequency. If only voice prompt is enabled, the device will output voice prompt. If voice prompt and LED indicators are enabled at the same time, LED 1 will flash in red in low frequency, while the device will output voice prompt.
 - Press the recording button in the sleeping mode. The screen will be woken up if the voice prompt or LED indicators are not enabled either. The recording status icon changes to red on the status bar, indicating the device is recording.
 - Press the recording button when the screen has been woken up. The recording status icon changes to red on the status bar, indicating the device is recording.
2. Press the recording button again to stop recording.
3. **Optional:** Select **Playback** on the main menu to view the recorded video.



Note

- If you want to record a period of time before recording starts, select **Camera Settings** → **Pre-Record** to set pre-record.
 - If you want to record a period of time after recording ends, select **Camera Settings** → **Post-Record** to set post-record.
-

3.2.2 Tape

You can tape audio via the device.

Steps

1. Press  (taping button).

The white taping icon appears in the lower center of the live view page, indicating the device is taping.
2. Press the taping button again to stop taping.

The white taping icon disappears, indicating the taping stops.
3. **Optional:** Select **Playback** on the main menu to view the taped audio.

3.2.3 Capture

You can capture picture via the device.

Steps

1. Press  (capture button).

The device captures a picture.

- 2. Optional:** Select **Playback** on the main menu to view the captured pictures.

3.3 Playback

You can play back video, audio, and picture via the device.

Steps

1. Select **Playback**.
2. Select **Video**, **Audio**, or **Picture**.
3. Select the file to play or view from the file list.

4 FAQ

4.1 Why does the device fail to start up?

Possible Reason

The device is out of power.

Solution

Shut down the device and connect it to the charger to charge for at least 20 minutes.

4.2 Why does the device fail to record?

Possible Reason

There is insufficient memory.

Solution

Back up the data in the device and clear the storage.

Possible Reason

Formatting storage error.

Solution

Format the device via Body Camera Assistant.

4.3 Why does the device fail to dial?

Possible Reason

Wi-Fi is enabled and connected.

Solution

Disable Wi-Fi.

Possible Reason

3G/4G SIM card is not installed well.

Solution

Reinstall 3G/4G SIM card.

Possible Reason

3G/4G SIM card is fees owed.

Solution

Renew the card.

Possible Reason

The device is abnormal.

Solution

Reboot the device.

4.4 Why cannot the device be logged in to via Body Camera Assistant?**Possible Reason**

The password is incorrect.

Solution

Reset your password.

Possible Reason

The device is abnormal.

Solution

Reboot the device.