

# Cable and Antenna Measurements Using Tektronix USB Spectrum Analyzers

---

APPLICATION NOTE



This application note looks at the basics of line sweeping measurements on cable and antenna systems using a spectrum analyzer and a tracking generator, including a look at why they are important and how to perform them. Specific measurements covered include return loss/voltage standing wave ratio (VSWR), cable loss, antenna isolation, and distance to fault (DTF) measurements.

Tracking generators play a key role in allowing spectrum analyzers to perform transmission loss, transmission gain, and return loss measurements. As will be discussed later, tracking generators are simply variable, or swept, RF generators that track with the spectrum analyzer sweep frequency. In other words, the tracking generator produces signals as the analyzer sweeps, measuring power across a frequency range. This allows the user to provide a known stimulus to a circuit and view the response.

There are a number of portable spectrum analyzers on the market today available with tracking generators. However, the majority of this equipment incorporates slow, low-power processors and offer limited to no real-time capabilities. The Tektronix family of USB spectrum analyzers, on the other hand, work in conjunction with a laptop or tablet PC to offer desktop-level real-time performance in an easily portable package, including models that are battery powered and IP52 rated.

## Cable and Antenna Testing – What Can Go Wrong?

It's estimated that about 60 percent of cellular base station problems result from faulty cables, connectors and antennas. Some problems occur during installation and are immediately apparent. But over time, connecting cables, adapters and antennas may become damaged or gradually degrade. Component failures often result in poor coverage and unnecessary handovers in the case of cellular systems. But cellular is simply the most obvious and pervasive example – any communication system is bound to degrade without ongoing testing to verify performance and isolate the source of problems.

Cabling and antennas are expected to cope with a diverse range of environments including outdoor and indoor installations, each posing different challenges.

Typical outdoor installations involve mounting antennas on the tops of tall buildings or on towers, often in remote locations where the antenna and portions of the coaxial cabling can be exposed to extreme weather conditions including wide temperature swings, rain, snow, ice, wind and lightning. Such conditions can exact a major toll on the integrity of the system, resulting in physical damage such as failed waterproofing at connector joints, failed cable splice seals, and cracks in insulating materials.

Indoor installations range from stationary set-ups like equipment shelters and office buildings to more mobile (and therefore more vulnerable) applications on ships, airplanes and trains, as well as cars and trucks. Even sheltered installations face a range of hazards including mishandling, stress, heat, vibration, chemicals and contamination. Problems are especially prevalent where solder joints and cable crimps weaken over time and break or degrade.

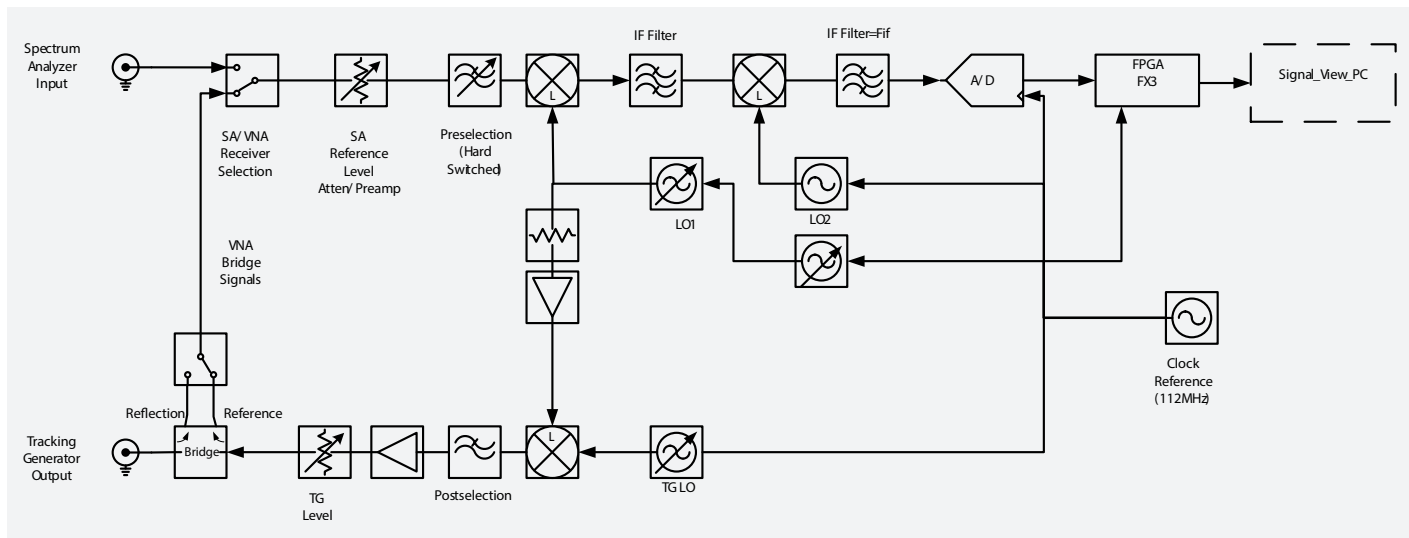

FIGURE 1. RSA500/600 Series spectrum analyzer with optional tracking generator.

Running cables up and down towers, through walls or underground can be a messy job. It's not hard to tear, stretch, dent, crush or poorly route a cable during installation – problems that can sometimes manifest themselves long after the initial installers have moved on. Another problem occurs when the minimum bend radius is exceeded such as in the case of low-loss coaxial cables, which can significantly degrade electrical performance.

Fortunately, it is not necessary to use highly specialized tools for cable and antenna test and troubleshooting. Portable spectrum analyzers are already used in the installation and maintenance of RF transmission systems, and are already used to test many different aspects of an RF transmission system, from overall performance to analysis of individual components. Therefore, adding a tracking generator to a spectrum analyzer is a cost-effective solution to the problem.

## Tracking Generator Basics

Since spectrum analyzers receive and measure a signal, they can be considered passive instruments. As such, spectrum analyzers, by themselves, are not able to make cable and antenna measurements that require known signals to be applied to a particular device or network under test in order to measure the output or response.

There are two main types of test equipment used for making these stimulus-response measurements. The traditional type of test equipment is an RF or scalar network analyzer. The other option is a spectrum analyzer with a tracking generator. A vector network analyzer is typically required if exceptional accuracy is needed, but in most other cases a spectrum analyzer and tracking generator arrangement is an excellent solution. This is particularly true with the advent of low-cost high-performance USB-based spectrum analyzers.

The tracking generator operates by providing a sinusoidal output to the input of the spectrum analyzer. By linking the sweep of the tracking generator to the spectrum analyzer, the output of the tracking generator is on the same frequency as the spectrum analyzer, and the two units track the same frequency. As shown in Figure 1, the return loss bridge is the subsystem that allows reflections of the generated signal to be detected by the spectrum analyzer.

Connecting the output of the tracking generator to the input of the spectrum analyzer, such as during normalization, results in a single flat line, with the level representing the reference loss of the direct connection. For measurements, an unknown device is placed between the output of the tracking generator and the input of the spectrum analyzer. The response of the device under test alters the signal and this change is then measured by the spectrum analyzer.

## Normalization, Calibration and Measurements

Tracking generators in spectrum analyzers may either make purely scalar measurements, or they may measure vector parameters. For transmission gain measurements, the RSA500 and RSA600 uses a scalar normalization of the measured power to create a normalized display of frequency vs. amplitude. However, for measurements such as return loss, VSWR, cable loss, and distance to fault, a vector calibration is required. The RSA500 and RSA600 are shipped with a factory vector calibration that is useful for many troubleshooting applications and can be fully user-calibrated using an Open, Short, Load (OSL) method for greater accuracy. More information on calibration techniques can be found in the user help files for SignalVu-PC. All of the vector measurements made in this application note were performed using the factory calibration provided in the instrument.

### Return Loss and VSWR

Return loss and VSWR measurement are at the core of cable and antenna measurements. These measurements allow the user to determine if the system in question is working the way it should. If problems show up during this test, chances are that the system's overall performance is being impacted. These measurements are based on the principle that some parts of a signal are reflected due to mismatches in impedance between cables, antennas, or connectors. The ratio of the input signal to the reflected signal is called the voltage standing wave ratio or VSWR. This ratio can also be measured in dB, and expressed as return loss.

Return loss and VSWR can reveal significant problems. For instance, a poorly matched antenna will reflect costly RF energy which will not be available for transmission and will instead end up in the transmitter. This extra energy returned to the transmitter can distort the signal and affect the efficiency of the transmitted power, reducing coverage area.

Return loss and VSWR show the same information expressed in different ways. To convert from VSWR to return loss:

$$\text{VSWR} = \frac{1 + 10^{-(\text{RL}/20)}}{1 - 10^{-(\text{RL}/20)}}$$

$$\text{Return Loss} = 20 \log \left| \frac{\text{VSWR} + 1}{\text{VSWR} - 1} \right|$$

The return loss is the ratio of reflected power to reference power in dB. The return loss view is usually preferred because of the benefits with logarithmic displays – it's easier to compare a small and large number on a logarithmic scale. The default return loss scale for Tektronix USB spectrum analyzers is +10 dB to -40 dB since this falls into the zone for most measurements and fits well in a standard display. For reference, a 20 dB system return loss measurement is considered very efficient as only 1 percent of the power is returned and 99 percent of the power is transmitted. If the return loss is 10 dB, 10 percent of the power is returned. While different systems have different acceptable return loss limits, 15 dB or better is a common system limit for a cable and antenna system.

In contrast to return loss, VSWR displays the impedance match of the system linearly, measuring the ratio of voltage peaks and valleys. If the match isn't perfect, the reflected signal will add and subtract from the transmitted signal. The greater this number, the worse the match. A perfect or ideal match in VSWR terms would be 1:1. A more realistic match for a cable and antenna system is in the order of 1.43 (15 dB return loss). Antenna manufacturers typically specify the match in VSWR based on a certain operating frequency and characteristic impedance. Higher VSWR's indicate a greater degree of impedance mismatch and can be viewed as having less efficient power transfer. The default scale of VSWR for Tektronix USB instruments is 1 to 10.

Tektronix' RSA500 and RSA600 spectrum analyzers with the added tracking generator option allow for return loss and VSWR measurements. In Figure 2, return loss of a bandpass filter swept from 700 MHz to 2.6 GHz is being measured. Markers have been placed at 1.458 GHz (-53.8 dB return loss) and at 1.67 GHz (-13.04 dB return loss), indicating the best and worst match in the passband of the filter.

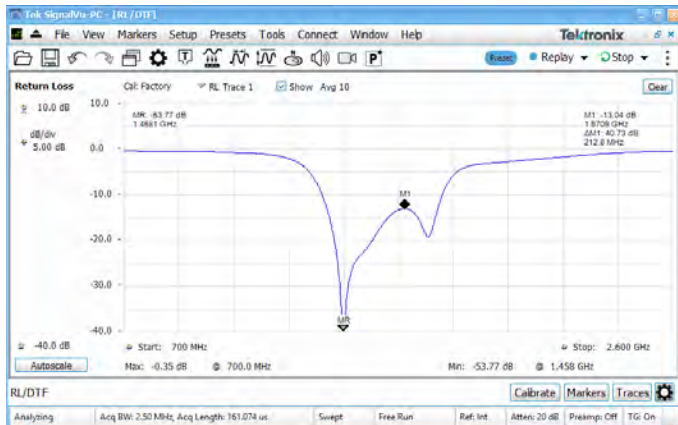

FIGURE 2. Return loss vs. Frequency of a bandpass filter.

Alternatively, Figure 3 shows the same bandpass filter being measured for VSWR. Once again, markers have been placed at 1.458 GHz (1.00 VSWR) and at 1.67 GHz (1.57 VSWR), indicating the best and worst match in the passband of the filter.

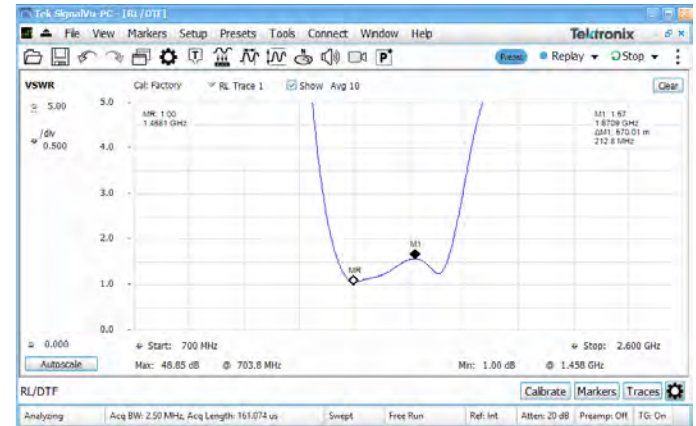

FIGURE 3. VSWR vs. Frequency of a bandpass filter.

As expected, the VSWR measurement corresponds with the return loss measurement.

## Cable Loss

Signals dissipate energy as they travel through cables and components. But by how much? This insertion loss or cable attenuation in transmission lines impacts the overall performance of RF systems and should be factored into VSWR analysis. In extreme cases, cable loss can mask antenna degradation or even outright failures.

Cable loss measurements will typically look at the total insertion loss of the transmission cable system, including coax cables, jumper cables and connectors. Other components such as combiners or filters may factor in as well. Any antennas or Tower Mounted Amplifiers (TMAs) should be removed prior to testing.

Performing cable loss measurements with the RSA500 or RSA600 spectrum analyzer with the tracking generator option is similar to the return loss measurement. In this case, a short is placed at the far end of the cable to reflect back the signal and the instrument computes the energy lost in the cable over a swept frequency. As shown in Figure 4, the system displays cable loss or insertion loss from 700 MHz to 2.6 GHz.

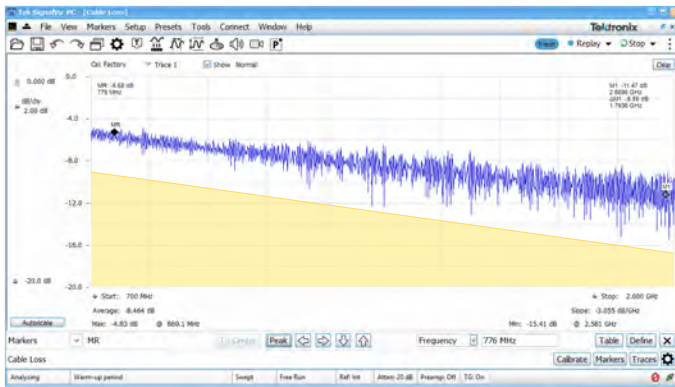

FIGURE 4. Cable Loss (Insertion Loss) vs. Frequency of 50 ft. RG-58/U coax cable with a mask applied.

The average cable loss of 8.464 dB and slope of 3.055 dB/GHz is conveniently displayed below the measurement in SignalVu-PC.

Cables have different insertion losses at different frequencies. For example, the cable measured here has a loss of 5.58 dB at 776 MHz, while at 2.57 GHz the cable loss is 11.47 dB. As the frequency increases or the cable length increases, the amount of cable insertion loss increases.

A cable loss measurement is a useful tool for discovering signs of degradation. As transmission line systems age, their losses also tend to increase. Any changes in loss can be discovered by comparing measurements to historical data. SignalVu-PC allows for traces to be stored and masks to be made for easy visual comparison to previous results. In Figure 4, a mask (pictured in yellow) has been applied based on the specification of the cable. If the cable loss measurement dips below the mask, the user is notified of the violation so that they can take steps to address the problem.

## Tracking Down Faults

If you've determined that return loss and associated VSWR or cable loss are out of spec, the next step is to find possible locations for the fault – or faults – in the transmission system. Here's where the distance to fault (DTF) measurement is used to troubleshoot the system and identify or pinpoint the location of a fault or discontinuity.

The DTF measurement is based on the same information as a return loss measurement. The spectrum analyzer sweeps the cable in the frequency domain and then uses an inverse Fast Fourier Transform to convert the data to the time domain.

The dielectric material used in cables affects the propagation velocity and thus the velocity of signals traveling through a given cable. The accuracy of the propagation velocity ( $V_p$ ) value determines how accurate the DTF measurement is at locating discontinuities. A  $\pm 5\%$  error in the  $V_p$  value has a corresponding impact on distance accuracy. Typically, the  $V_p$  value is pulled from the manufacturer's datasheet, providing a good starting point. It's important to note, however, that there will always be some variance when all the components in a system such as adapters and jumpers are factored in.

One of the more powerful applications for DTF is as a troubleshooting tool to monitor changes in the system over time. In this way, it can be discovered that a connector's performance degraded significantly from one year to the next, for instance. The absolute numbers are less important than the relative change. Used in this manner, DTF offers a powerful way to troubleshoot cable and antenna systems.

In DTF measurements, it's important to select the appropriate frequency range according to your application. For return loss measurements, the frequency range is usually specified by the device under test. However, for DTF analysis, the resolution and maximum distance range are dependent on three parameters:

1. The frequency sweep range
2. The number of data points
3. The relative propagation velocity of the cable being tested

When checking the return loss of an antenna in DTF mode, the operating frequency range of the antenna should be used. However, for DTF analysis of cables, the frequency range is largely dependent on the maximum distance and resolution of the measurement.

When checking transmission lines for potential faults or degradation, it's generally best to use a large frequency span in order to obtain a small DTF resolution. However, the frequency range is constrained by the maximum distance. More specifically, the maximum distance is inversely proportional to the frequency range. Therefore, the wider the frequency range, the smaller the maximum distance that can be measured.

$$\text{Max Distance (meters)} = \frac{V_p \times C}{2} \times \frac{1}{\Delta f}$$

$$\Delta f = \frac{\text{BW}}{N-1} = \frac{F_{\text{stop}} - F_{\text{start}}}{N-1}$$

$V_p$  = Relative Velocity Factor of Transmission Path

$C$  = Speed of Light

$N$  = Number of Data Points

$\text{BW}, F_{\text{start}}, F_{\text{stop}}$ , in Hz

When maximum distance is given in a problem, a certain number of data points ( $N$ ) and bandwidth ( $\text{BW}$ ) that can yield to that maximum distance or greater, must be determined.

There is also a relationship between the frequency range and the resolution of a DTF measurement: the wider the frequency range, the smaller the resolution.

$$\text{BW} = \frac{V_p \times C}{2} \times \frac{1}{\Delta d}$$

$$\text{Resolution (meters)} = \Delta d = \frac{V_p \times C}{2} \times \frac{1}{\text{BW}}$$

Increasing the  $\text{BW}$  means narrowing the distance resolution. A smaller resolution is generally preferred in a DTF measurement because it yields greater measurement accuracy.

When  $\text{BW}$  is given in a problem, a certain number of data points ( $N$ ) and relative frequency range ( $\Delta f$ ) that can yield to that bandwidth or less, must be determined.

## Performing DTF Measurements

Now that we've discussed the principles behind DTF measurements, let's look at the actual steps involved with setting up these measurement using SignalVu-PC and an RSA500/RSA600 with the tracking generator option. In SignalVu-PC, the DTF Setup button is found under the RL/DTF setting tab and allows for the measurement to be limited based on either distance or bandwidth.

1. In SignalVu-PC, select Setup > Displays.
2. In the Measurements panel, select Return Loss.
3. Double click the RL/DTF icon in the Available displays panel to select that display, and then click OK.
4. Click  to open the RL/DTF Settings control panel.
5. Click on the Displays tab, select DTF/Return Loss for Display 2, and then select Display 2 in the Show Displays panel to view the DTF/Return Loss display only as shown in Figure 5.

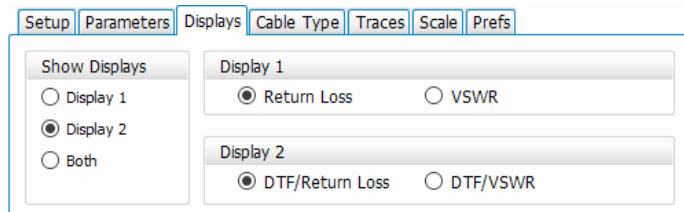

FIGURE 5. DTF setup in SignalVu-PC.

6. Use the Parameters tab to set the Output Power Level and the DTF Window view. Use the Traces, Scale, and Prefs tabs to set various trace and display preferences.
7. Select the Cable Type tab and specify the cable type. If the cable type is not listed, you can add a cable by clicking the New Cable button. This provides access to the New Cable panel where you can add a name, propagation velocity constant, and loss for the cable as show in Figure 6.

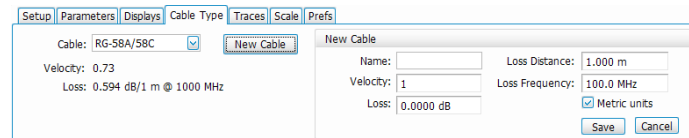

FIGURE 6. Selecting a cable type or defining a new cable.

8. Click on the DTF Setup button to open the DTF Setup window. Here, you can specify the measurement to be limited based on either distance or bandwidth.
9. Set the Cover Distance as shown in Figure 7. Specify the length of the cable or the distance to the DUT (for example, an antenna). This setup is recommended when there are no frequency limitations on the signal path between the analyzer and the system under test, such as when an antenna and cable are being tested. However, you can reduce the cover distance to just include the fault (for example, if your cable is 100 m long, but there is one fault at 30 m, you can reduce the distance to 35 m). Using a smaller cover distance results in increased trace resolution for a given number of points.
11. In the Parameters column of the DTF Setup window, change the Center Freq, if needed. A range of values for the center frequency is provided as an aid. The center frequency depends on the system or DUT.
12. Select the Method: Fast, Normal, Long Distance (if Limit Bandwidth is selected), or High Resolution (if Cover Distance is selected). Each method provides a range of number of points for the frequency sweep. The Fast method has the smallest range of points, and the Long Distance and High Resolution methods have the largest range of points. If you select Limit Bandwidth, increasing the number of points will result in a longer distance because the bandwidth must be kept limited; therefore, the frequency step of the sweep is reduced.

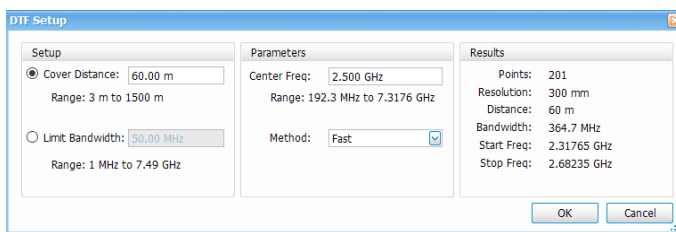

FIGURE 7. Setting cover distance.

10. If you want to set a bandwidth limit for the system instead of using distance, select Limit Bandwidth as shown in Figure 8. Otherwise go to step 11.

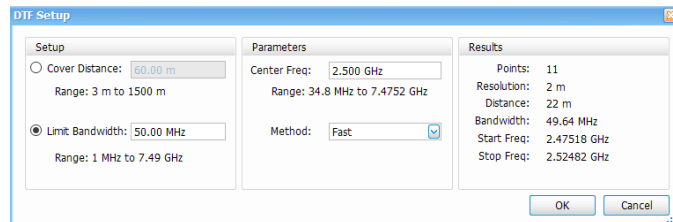

FIGURE 8. Setting bandwidth limit.

This setup is recommended when frequency-limited devices, such as filters, are in the signal path between the analyzer and the system under test.



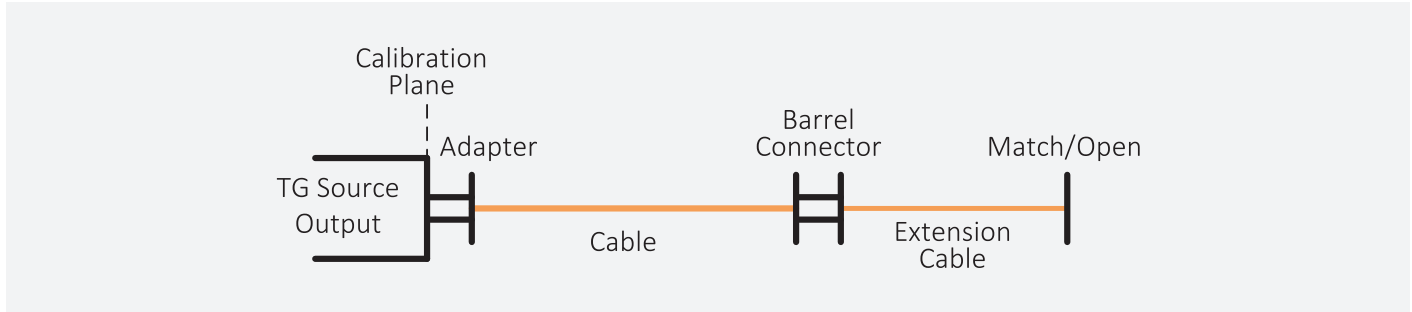

FIGURE 9. Typical Distance to Fault Measurement Setup.

A typical distance to fault measurement setup for a cable with an inserted barrel and an open-ended extension cable is displayed in Figure 9. In Figure 10, return loss vs. distance is measured. When examining the display, spikes in amplitude are located at the points where discontinuities exist along the transmission line. The point marked by MR at 16.602 meters is the barrel connector, and the point marked by M1 at 17.677 meters is the end of the cable. In this case, because the cable is open-ended, a large portion of the power is being reflected at the end of the cable. The amplitude spikes located beyond M1 indicate multiple reflections in the two cables. The first reflection after M1 is caused by a signal that has traveled once through the first cable (in both directions) and traveled twice through the second cable due to the signal bouncing between the open-ended cable and the barrel connector.

In addition to return loss, VSWR can also be used to identify faults in a transmission system. In Figure 11, VSWR vs. distance is measured for the same cable system. Here, any discontinuities can be easily identified as being any spikes in amplitude above the VSWR value of 1. SignalVu-PC's ability to display both return loss and VSWR in DTF measurements makes it a powerful tool for visualizing and identifying faults.

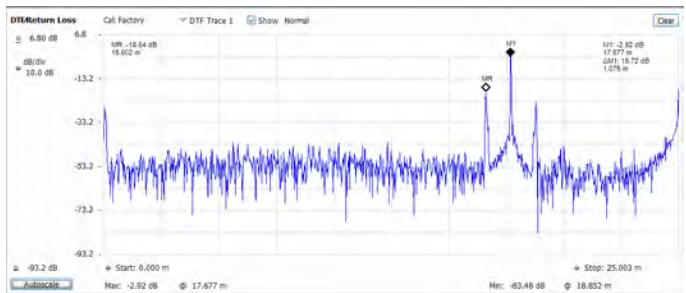

FIGURE 10. Return Loss vs. Distance.

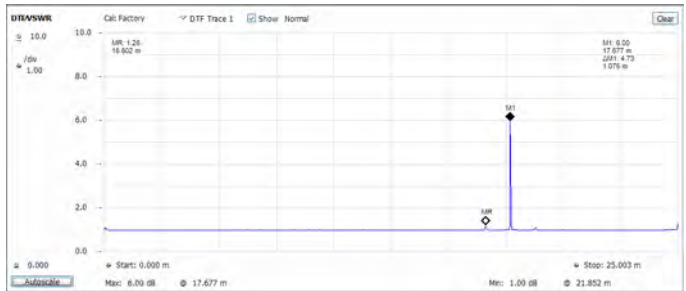

FIGURE 11. VSWR vs. Distance.

## Co-Located Antenna Testing

In many wireless applications, such as the cell tower in Figure 12, different systems are co-located on towers and other structures. In such situations considerable care must be given to antenna placement, regardless of whether they are part of the same system or not. It's important to maintain an adequate level of isolation in order to keep intermodulation products from being created on the transmission side or to avoid noise desensitization in the receivers.



FIGURE 12. Cell Tower Using Co-Located Antenna Systems.

Intermodulation and desensitization can occur when energy from one high power transmitter radiates from its antenna and couples into a nearby antenna and enters the amplifiers of the coupled system. Systems designed with duplexing and other filters can reject signals from nearby transmitters and other interferers but even with these safeguards an antenna-to-antenna isolation of 60 dB or more may be required.

This type of analysis can be accomplished using either an RSA500 or RSA600 spectrum analyzer with a tracking generator option. The test setup can be seen in Figure 13 with the tracking generator port connected to the transmitting antenna, and the RF port of the spectrum analyzer connected to the receiving antenna. A sweep is then performed from the lowest transmit frequency in the system to the highest receive frequency in the system. From these measurements, isolation vs. frequency plots show the isolation levels between any two antennas at various frequencies.

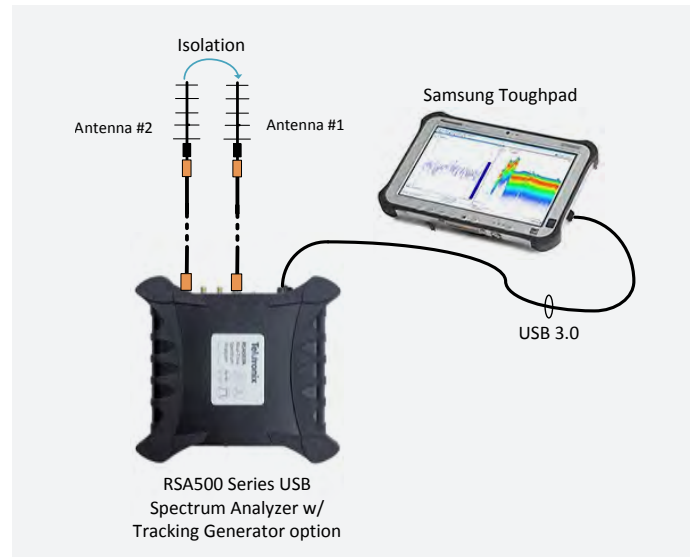

FIGURE 13. Co-Located Antenna Isolation Test Setup.

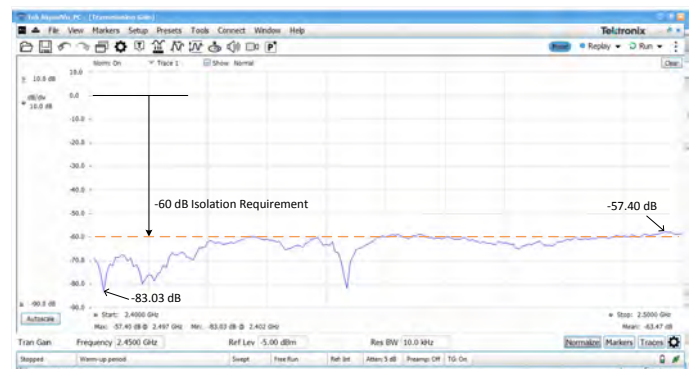

FIGURE 14. Isolation vs. Frequency Measurement

The measurement shown in Figure 14 was taken in the Industrial, Scientific and Medical (ISM) band using SignalVu-PC's Transmission Gain display. The measurement shows the isolation of two antennas placed 60 degrees off-axis from each other, transmitting from 2.4 GHz to 2.5 GHz. To make this measurement, the tracking generator was first normalized using a through connection with the two cables used to connect to the antennas. The through connection was removed and the antennas were connected. The measurement indicates -57.4 dB to -83.03 dB of isolation as shown in the max and min readouts on the screen. When maintaining records, traces can be saved and trace data exported for use with external programs. Masks can also be made for easy visual comparison to previous results.

## Tektronix RSA500 and RSA600

The RSA500 series was built to bring real-time spectrum analysis to solving the problems of spectrum managers, interference hunters, and network maintenance personnel who need to track down hard to find interferers, maintain RF networks, and keep records of their efforts. The RSA500 offers rugged, compact packaging and optional battery power. The RSA600 offers the same capabilities, but in a line-powered enclosure well suited for lab environments. Both are small form factor, high performance spectrum analyzers with tracking generator capabilities.

The hearts of both systems are comprised of a USB-based RF spectrum analyzer that captures 40 MHz bandwidths with exceptional fidelity. With 70 dB dynamic range and frequency coverage to 7.5 GHz, all signals of interest can be examined with high confidence in measurement results. The USB form factor moves the weight of the portable instrument off of your hands, and replaces it with a lightweight Windows tablet or laptop.

The RSA500 and RSA600 series operate with SignalVu-PC software, a powerful program used as the basis of Tektronix's traditional spectrum analyzers, offering a deep analysis capability previously unavailable in high performance battery-operated solutions. Real-time processing of the DPX spectrum/spectrogram is enabled in a PC, further reducing the cost of hardware.

Thanks to its integrated return loss bridge (Figure 1), the optional tracking generator enables gain/loss measurements for quick tests of filters, duplexers and other network elements as well as cable and antenna measurements of VSWR, return loss, distance to fault and cable loss. In addition to this, Tektronix offers an array of calibration kits and accessories to help ensure precise and accurate measurements can be taken.

## Summary

Wireless communication systems require that antennas, as well as the cabling systems between transmitters, receivers and antennas, are all in top working order, or the performance of the system will begin to suffer. Line sweeping measurements such as return loss and VSWR allow engineers and technicians to verify and troubleshoot the electrical performance of RF and microwave transmission systems and antennas. When problems are identified, DTF measurements make it easy to pinpoint the location of the fault. These measurements are fast, efficient and effective using Tektronix RSA500 or RSA600 USB-based spectrum analyzers with optional tracking generator functionality.

## For more information:



### Vicom Australia

1064 Centre Road, Oakleigh South, Vic, 3167  
Australia  
1300 360 251  
info@vicom.com.au  
www.vicom.com.au

 Follow us on LinkedIn  
<http://www.linkedin.com/company/vicom-australia>

### Vicom New Zealand

Grd Floor, 60 Grafton Road, Auckland 1010  
New Zealand  
+64 9 379 4596  
info@vicom.co.nz  
www.vicom.co.nz

 Follow us on LinkedIn  
<http://www.linkedin.com/company/vicom-new-zealand>

### Contact Information:

**Australia\*** 1 800 709 465  
**Austria** 00800 2255 4835  
**Balkans, Israel, South Africa and other ISE Countries** +41 52 675 3777  
**Belgium\*** 00800 2255 4835  
**Brazil** +55 (11) 3759 7627  
**Canada** 1 800 833 9200  
**Central East Europe / Baltics** +41 52 675 3777  
**Central Europe / Greece** +41 52 675 3777  
**Denmark** +45 80 88 1401  
**Finland** +41 52 675 3777  
**France\*** 00800 2255 4835  
**Germany\*** 00800 2255 4835  
**Hong Kong** 400 820 5835  
**India** 000 800 650 1835  
**Indonesia** 007 803 601 5249  
**Italy** 00800 2255 4835  
**Japan** 81 (3) 6714 3010  
**Luxembourg** +41 52 675 3777  
**Malaysia** 1 800 22 55835  
**Mexico, Central/South America and Caribbean** 52 (55) 56 04 50 90  
**Middle East, Asia, and North Africa** +41 52 675 3777  
**The Netherlands\*** 00800 2255 4835  
**New Zealand** 0800 800 238  
**Norway** 800 16098  
**People's Republic of China** 400 820 5835  
**Philippines** 1 800 1601 0077  
**Poland** +41 52 675 3777  
**Portugal** 80 08 12370  
**Republic of Korea** +82 2 6917 5000  
**Russia / CIS** +7 (495) 6647564  
**Singapore** 800 6011 473  
**South Africa** +41 52 675 3777  
**Spain\*** 00800 2255 4835  
**Sweden\*** 00800 2255 4835  
**Switzerland\*** 00800 2255 4835  
**Taiwan** 886 (2) 2656 6688  
**Thailand** 1 800 011 931  
**United Kingdom / Ireland\*** 00800 2255 4835  
**USA** 1 800 833 9200  
**Vietnam** 12060128

\* European toll-free number. If not accessible, call: +41 52 675 3777

Find more valuable resources at [TEK.COM](http://TEK.COM)

