

# KickStart

(Beta version)

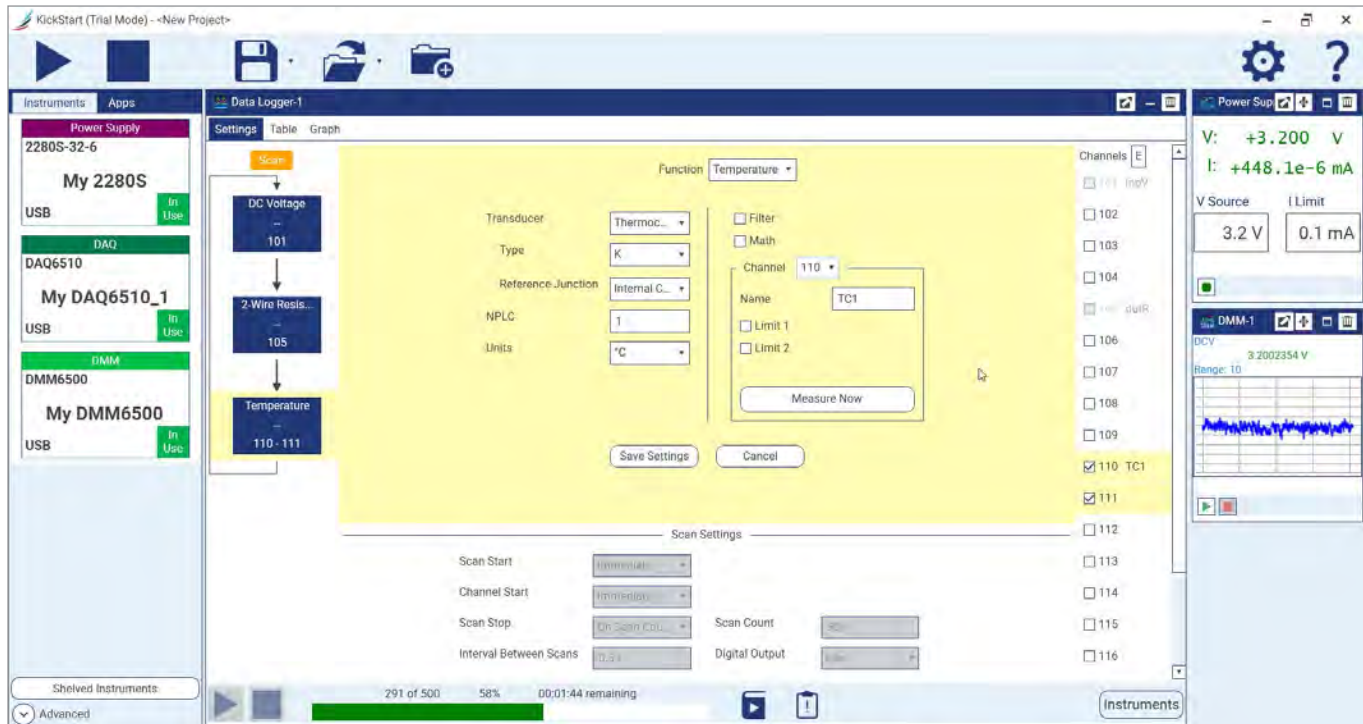

Accelerate the path to the measurements you want with KickStart Software. KickStart simplifies what you need to know about the instrument so that in just minutes you can take the instrument out of the box and get real data on your device. By plotting data immediately and offering quick statistical summaries of the data in the reading table, KickStart allows you to gather insights faster and make the decisions you need to move on to the next stage of device development. KickStart saves you time by facilitating quick replication of tests and comparison of results using convenient export features. With KickStart, you can focus on interpreting the test results so that your team can meet their innovation goals.

## Key Features

KickStart Software for the PC enables quick test setup and data visualization when using multiple instruments.

- Save time by automating data collection of millions of readings.
- Set up a multi-instrument test with the ability to independently control up to eight instruments.
- Supports power supplies, source measure unit (SMU) instruments, DMMs, and dataloggers.
- Replicate tests quickly using saved test configurations.
- Use built-in plotting and comparison tools to quickly discover measurement anomalies and trends.
- Export data in ready-to-use formats for reports and additional analysis.

## Applications

- Device characterization: Characterize materials and discrete components and verify design of electronic modules.
- Datalogging: Reliably log data to the PC; useful for testing device compliance to regulatory or industrial standards.

## Minimized Time to Results

Connect your instrument to your PC and have KickStart discover your instrument in seconds. KickStart supports instruments connected using GPIB, LAN, and USB interfaces. With a simple drag of the mouse, launch an app to control and collect data from an instrument. KickStart can collect millions of readings from each instrument, which makes it a great solution for your long-term datalogging needs and for capturing a lot of data from transient events with a digitizing DMM. KickStart presents the data in tabular and graphical formats. In the table, KickStart presents a statistical summary of the data in each column. You can hide non-essential data, and the statistics automatically update to reflect only data visible in the table. This can be quite useful for applications in which you want to monitor devices after they have reached thermal stabilization.

KickStart provides a test solution even when your tests involve the control of multiple instruments. One of the largest enhancements for KickStart Version 2.0 is the control of multiple instruments through a single interface. You can launch and run up to eight apps at the same time. You can see results from multiple instruments in a single easy-to-view format.

Time (t)	Resistance (i)	Resistance (i2)	Resistance (i2)	Resistance (i2)	Resistance (i2)
56	15.878171	1.028459e+6	1.003070e+3	205.2355	4.751266e+3
57	16.164918	1.029070e+6	1.003070e+3	205.2350	4.751270e+3
58	16.432456	1.029290e+6	1.003070e+3	205.2344	4.751283e+3
59	16.741992	1.028452e+6	1.003071e+3	205.2349	4.751286e+3
60	17.030523	1.028414e+6	1.003071e+3	205.2348	4.751278e+3
61	17.319517	1.029278e+6	1.003071e+3	205.2348	4.751288e+3
62	17.608509	1.028830e+6	1.003071e+3	205.2348	4.751287e+3
63	17.897951	1.028494e+6	1.003071e+3	205.2351	4.751267e+3
64	18.187350	1.028299e+6	1.003070e+3	205.2343	4.751284e+3
65	18.474579	1.028564e+6	1.003071e+3	205.2352	4.751285e+3
66	18.763116	1.028138e+6	1.003071e+3	205.2340	4.751275e+3
67	19.051650	1.029005e+6	1.003071e+3	205.2348	4.751285e+3
68	19.340190	1.028797e+6	1.003070e+3	205.2350	4.751280e+3
69	19.628730	1.028879e+6	1.003070e+3	205.2347	4.751283e+3
70	19.917255	1.028752e+6	1.003072e+3	205.2346	4.751283e+3
71	20.205789	1.028891e+6	1.003072e+3	205.2352	4.751282e+3
Min	0.00000	1.008138e+6	1.003069e+3	205.2340	4.751267e+3
Max	20.2058	1.031195e+6	1.003075e+3	205.2395	4.751303e+3
Mean	10.1031	1.029230e+6	1.003070e+3	205.2352	4.751282e+3
StdDev	5.95789	468.1030	888.3387e-6	797.2339e-6	119.1568e-3

View data in the reading table in an easy to read format. Hide rows or columns to show only relevant data

Min	0.00000	1.028138e+6	1.003069e+3	205.2340
Max	20.2058	1.031195e+6	1.003075e+3	205.2395
Mean	10.1031	1.029230e+6	1.003070e+3	205.2352
StdDev	5.95789	468.1030	888.3387e-6	797.2339e-6

KickStart calculates basic statistics for each column of data visible in the table.

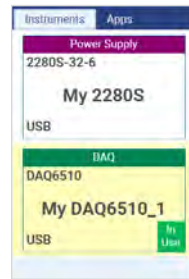

KickStart quickly discovers all connected instruments and allows you to create tests and view data even when instruments are not connected to the PC.

## Faster Insights into Data

KickStart plots your data immediately so that you can quickly discover anomalies or trends and make the needed decisions to get you to the next phase of development of your material, device, or module. Getting insights quickly is most important, so a large portion of the viewing area is dedicated to the graph. There are built-in tools to compare and overlay data from previous test runs. You can mark or highlight points of interest in the graph and use cursors to view detail on multiple data series at once.

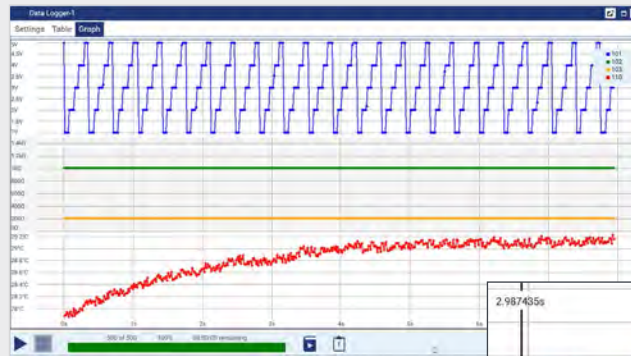

Data always gets prime focus in KickStart. Use the graph to discover measurement trends or anomalies.

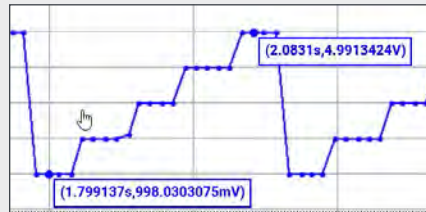

Use markers to highlight points of interest on the graph.

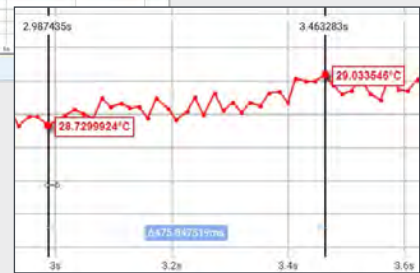

Use cursors to get information on multiple data series or to calculate differences on the horizontal scale.

## Peace of Mind. Confidence. Reliability.

Proving that your device or module complies with industrial and regulatory standards is an important part of ensuring that your device or electronic module will meet your customer's requirements. Safe archival of test data is essential in compliance testing. KickStart streams data from the instrument to PC storage media, so, even in the event of power outage, your data is preserved.

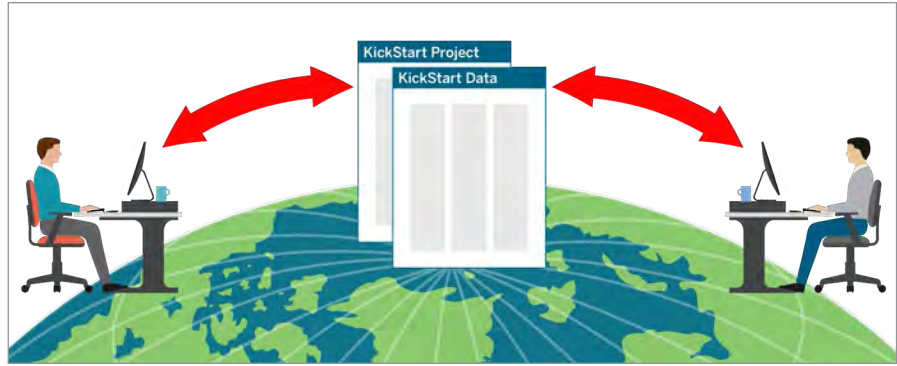

Save tests and share data for easy collaboration between multiple development sites.

Additionally, you can save any test project that you create to re-use later or to share with others. This allows you to replicate tests easily at other locations, which is essential when you work on a global development team.

KickStart even allows you to prepare your tests using simulated instruments so that you are ready to test once the actual instrument arrives. You can quickly swap the actual instrument in your test configuration later. The use of simulated instruments also allows offline viewing of the data and test setup.

### Available KickStart Apps

#### Base KickStart Apps

**KICKSTARTFL-BASE** includes four apps to control your SourceMeter® SMU Instrument, DMM, data logger, or power supply.

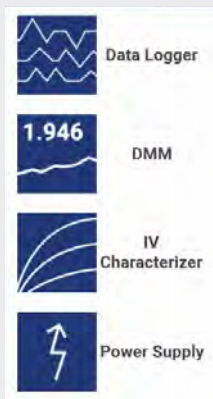

#### Premium Apps

**KICKSTARTFL-HRMA** is an optional app for KickStart Software that allows you to make insulation resistivity measurements with the 6517B Electrometer/ High Resistance Meter and the 8009 Resistivity Test Fixture.



## Power Supply App

This app simplifies supplying power to your device or system.

- Quickly set up automated tests using bias or list sweep mode.
- Interactively control bias conditions while monitoring measurements on another instrument.
- Use along with the Precision Multimeter App for application such as power consumption analysis or monitoring load current stability.
- Supports Keithley 2280S-32-6 and 22380S-60-3 Precision Measurement DC Power Supplies.

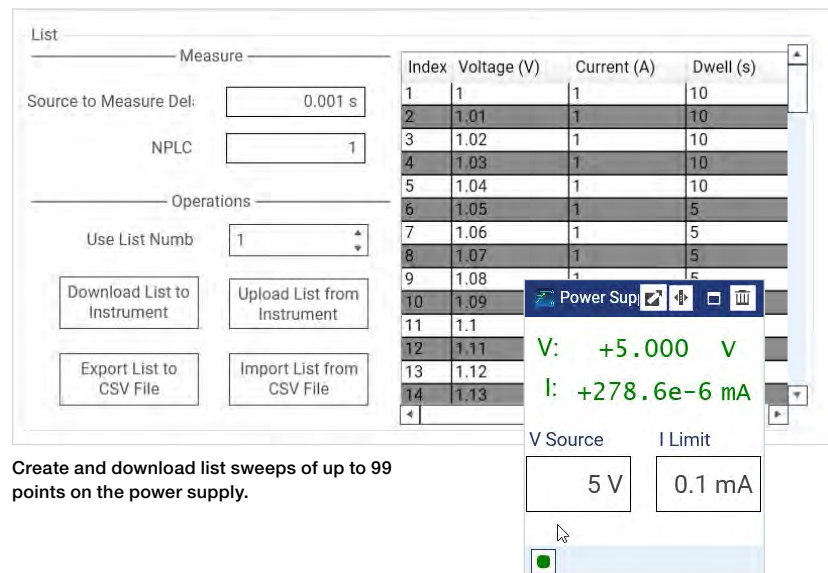

Index	Voltage (V)	Current (A)	Dwell (s)
1	1	1	10
2	1.01	1	10
3	1.02	1	10
4	1.03	1	10
5	1.04	1	10
6	1.05	1	5
7	1.06	1	5
8	1.07	1	5
9	1.08	1	5
10	1.09	1	5
11	1.1	1	5
12	1.11	1	5
13	1.12	1	5
14	1.13	1	5

Measure: Source to Measure Del: 0.001 s, NPLC: 1

Operations: Use List Numb: 1

Buttons: Download List to Instrument, Upload List from Instrument, Export List to CSV File, Import List from CSV File

Minimized View: V Source: 5 V, I Limit: 0.1 mA, V: +5.000 V, I: +278.6e-6 mA

Create and download list sweeps of up to 99 points on the power supply.

View and set the most essential parameters on the power supply in KickStart's minimized view.

## Precision Multimeter App

This app affords you a simple way to log data using your Keithley DMM.

- Automate long-term datalogging.
- Plot and inspect waveforms from the digitizer built into the DMM.
- Trigger digitizer on digital events or programmed analog levels.
- Supports Keithley DMM7510 7½-Digit and DMM6500 6½-Digit DMMs and DAQ6510 Data Acquisition and Logging Multimeter System.



Capture waveforms with the DMM6500 Digitizing DMM using KickStart's Precision Multimeter App.

## Data Logger App

Use the KickStart Data Logger App to set up and control your multi-channel data acquisition instrument. This app is designed to help you configure all your channels very quickly and even validate your connections during test configuration. It allows you to set up multiple channels with the same configuration but give each channel a meaningful label so that you can quickly scan your results and grab the information you need. Configure pass/fail limits for each channel in order to set alarm conditions and obtain quick visual verification of test results.

- Stream millions of readings to PC storage media for safe data archival.
- View multiple measurement functions in a single data window using stacked graphs.
- Plot measurement data versus another channel or versus time.
- Export data in ready-to-use formats for reports and additional analysis even while the test is running.
- Supports Keithley DAQ6510, DMM6500 (with scan card), 2700, 2701, and 2750.

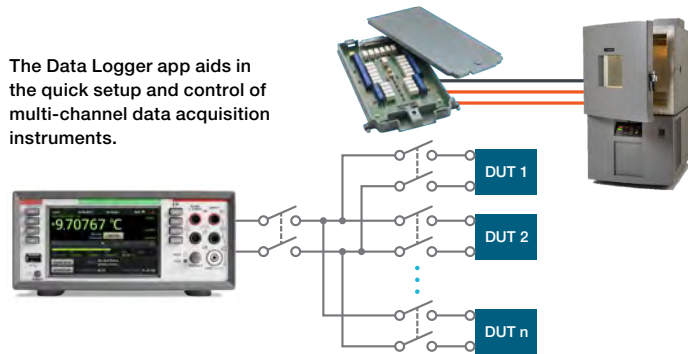

The Data Logger app aids in the quick setup and control of multi-channel data acquisition instruments.



Plot and view multiple channels in a single graph with KickStart's Data Logger App.

Create personalized labels for each channel of your data logging switch card.

Channels E	
<input checked="" type="checkbox"/>	101 inpV
<input type="checkbox"/>	102 102
<input type="checkbox"/>	103 103
<input type="checkbox"/>	104 104
<input checked="" type="checkbox"/>	105 dutR

## I-V Characterizer App

Use the I-V Characterizer App to perform current vs. voltage (I-V) test on a variety of materials, two-terminal and multi-terminal semiconductor devices, solar cells, and much more. You can configure each SMU for a variety of bias and sweep sourcing operations, including linear, log, list, and dual sweeps.

- Configure and control up to four SourceMeter SMU instruments with independent sweeps or multi-level sweeps.
- Differentiate SMU instrument channels and their measurement data using labels that are relevant to your device or module.
- Use built-in comparison tools to compare and overlay multiple test runs in a single graph.
- Create tests by mixing any of these SMU instruments: Series 2400, Series 2600B, and 6430 SourceMeter SMU Instruments.

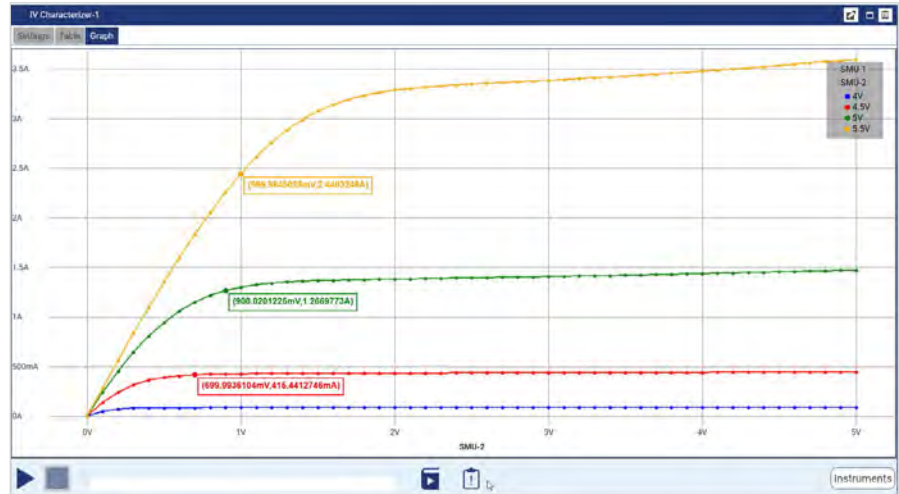

Create current vs. voltage characteristics for 2-terminal, 3-terminal, and 4-terminal devices.

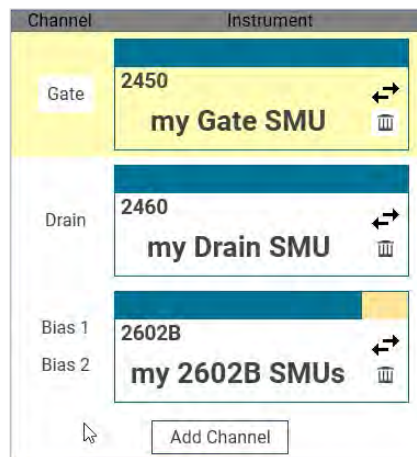

Characterize devices using up to four of Keithley's SourceMeter SMU instruments.

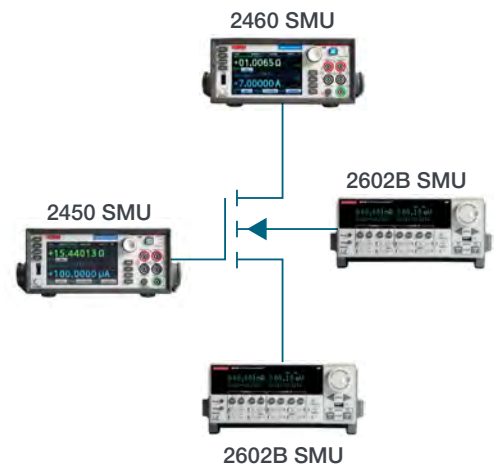

## KICKSTARTFL-BASE Availability and Ordering Information

Download the Beta version of KICKSTARTFL-BASE today from [www.tek.com/keithley-kickstart](http://www.tek.com/keithley-kickstart). This version of KickStart installs with a free 90-day trial license. The official version of KICKSTARTFL-BASE will be available from [tek.com](http://tek.com) starting July 15, 2018. It will install with a free 60-day trial.

## Recommended System Requirements

- CPU: Dual-core processor 2 GHz or better
- Memory: 8GB RAM
- Disk Drive: 8GB of free space
- Windows 10, 8, 7 64-bit
- PC disk space required: 1 GB
- Instrument communication interfaces: USB, GPIB, LAN
- Display resolution: Minimum 1920x1080 recommended

# Optional High Resistivity Measurement Premium Application (KICKSTARTFL-HRMA)

KickStart’s High Resistivity Measurement Application allows for reliable insulator resistivity measurement according to ASTM D257 standard. This app is designed for use with Keithley’s 6517B Electrometer/High Resistance Meter. The 6517B along with the 8009 Resistivity Test Fixture is a laboratory standard for volume and surface resistivity measurements on insulating materials.

The KickStart High Resistance Measurement Option makes it easier for you to:

- Perform a Step Response Test to identify electrification time appropriate to the material’s time constant.
- Observe resistivity dependence on temperature and relative humidity of environment using optional probes 6517-TP and 6517-RH.
- Use the alternating polarity measurement technique to eliminate inherent background currents for the most accurate resistivity measurements.

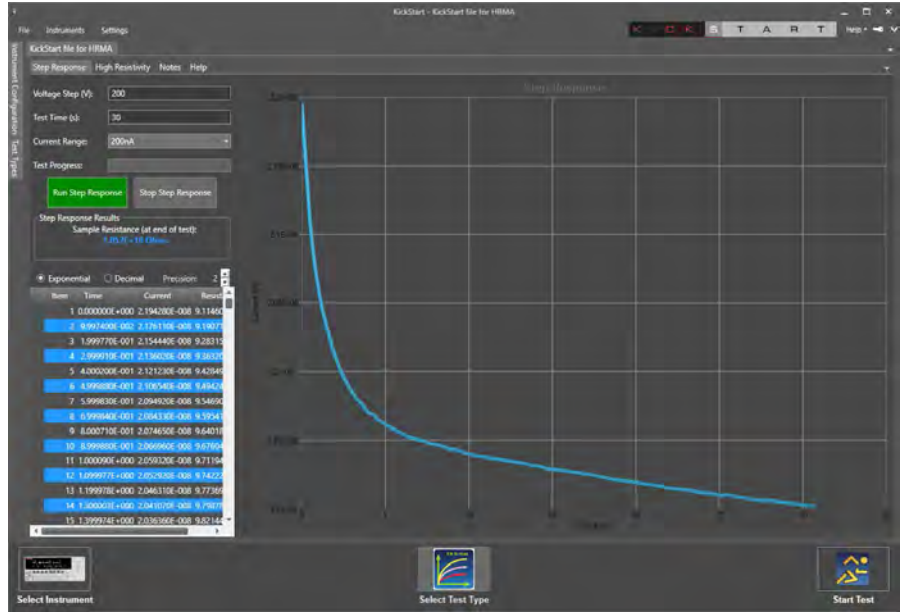

Use the Step Response Test to identify appropriate electrification time.

## Licensing Information

The KickStart High Resistivity Measurement Application requires the KICKSTARTFL-HRMA floating license. A floating license allows selected users to manage transfer of individual license to different PCs. This app requires installation of KickStart version 1.9.8. It is not yet compatible with KickStart 2.0. Please visit <http://www.tek.com/keithley-kickstart> to download KickStart version 1.9.8 and request a 30-day trial of the KICKSTARTFL-HRMA license.

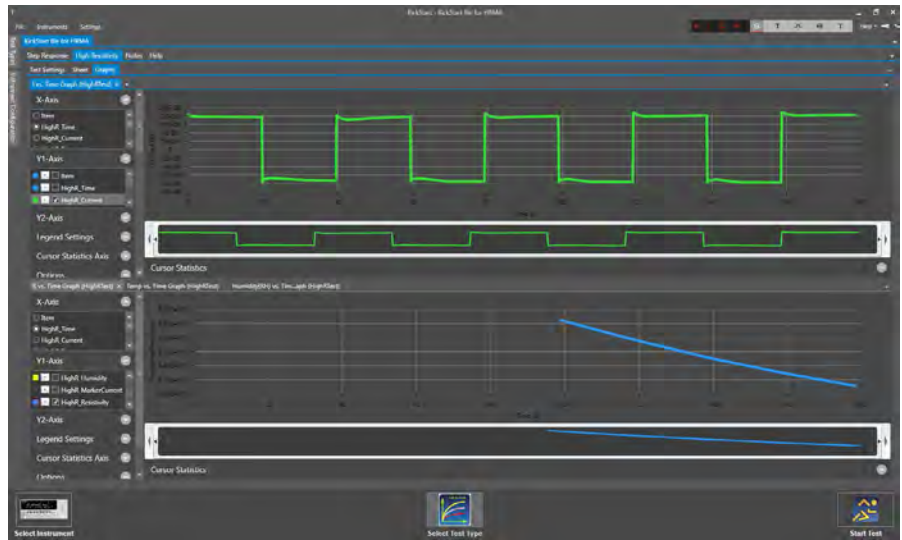

Hi-R test using the alternating polarity technique to improve accuracy in insulation resistance measurements.

## System Requirements for KICKSTARTFL-HRMA

- Windows 10, 8, 7 32-bit or 64-bit
- Processor: 1 GHz or faster (2 GHz or greater recommended)
- RAM: 1 GB (32-bit) or 2 GB (64-bit) (4GB or greater recommended)
- Disk drive space required: 600 MB
- Instrument communication interfaces: GPIB (for 6517B)
- Display resolution: Minimum 1024×768

### Learn More about KickStart

Visit [www.tek.com/keithley-kickstart](http://www.tek.com/keithley-kickstart) for the latest information about KickStart.

For questions, please visit Tektronix Technical Forums at <http://forum.tek.com> or contact your local Tektronix sales office noted on the back of this datasheet.

## Contact Information

**Australia\*** 1 800 709 465  
**Austria** 00800 2255 4835  
**Balkans, Israel, South Africa and other ISE Countries** +41 52 675 3777  
**Belgium\*** 00800 2255 4835  
**Brazil** +55 (11) 3759 7627  
**Canada** 1 800 833 9200  
**Central East Europe/Baltics** +41 52 675 3777  
**Central Europe/Greece** +41 52 675 3777  
**Denmark** +45 80 88 1401  
**Finland** +41 52 675 3777  
**France\*** 00800 2255 4835  
**Germany\*** 00800 2255 4835  
**Hong Kong** 400 820 5835  
**India** 000 800 650 1835  
**Indonesia** 007 803 601 5249  
**Italy** 00800 2255 4835  
**Japan** 81 (3) 6714 3086  
**Luxembourg** +41 52 675 3777  
**Malaysia** 1 800 22 55835  
**Mexico, Central/South America and Caribbean** 52 (55) 56 04 50 90  
**Middle East, Asia, and North Africa** +41 52 675 3777  
**The Netherlands\*** 00800 2255 4835  
**New Zealand** 0800 800 238  
**Norway** 800 16098  
**People's Republic of China** 400 820 5835  
**Philippines** 1 800 1601 0077  
**Poland** +41 52 675 3777  
**Portugal** 80 08 12370  
**Republic of Korea** +82 2 6917 5000  
**Russia/CIS** +7 (495) 6647564  
**Singapore** 800 6011 473  
**South Africa** +41 52 675 3777  
**Spain\*** 00800 2255 4835  
**Sweden\*** 00800 2255 4835  
**Switzerland\*** 00800 2255 4835  
**Taiwan** 886 (2) 2656 6688  
**Thailand** 1 800 011 931  
**United Kingdom/Ireland\*** 00800 2255 4835  
**USA** 1 800 833 9200  
**Vietnam** 12060128

\* European toll-free number.

If not accessible, call: +41 52 675 3777

Rev. 090617

### For More Information: Vicom Australia

1064 Centre Rd  
Oakleigh South Vic 3167  
Australia  
1300 360 251  
info@vicom.com.au  
www.vicom.com.au



### Vicom New Zealand

Grd Floor, 60 Grafton Road  
Auckland 1010  
New Zealand  
+64 9 379 4596  
info@vicom.co.nz  
www.vicom.co.nz



Find more valuable resources at [TEK.COM](http://TEK.COM)

Copyright © Tektronix. All rights reserved. Tektronix products are covered by U.S. and foreign patents, issued and pending. Information in this publication supersedes that in all previously published material. Specification and price change privileges reserved. TEKTRONIX and TEK are registered trademarks of Tektronix, Inc. All other trade names referenced are the service marks, trademarks or registered trademarks of their respective companies.

041018.SBG 1KW-60965-2

