

# Test guide to 5G network deployment:

Simplifying 5G deployment complexities with easy-to-use fiber, x-haul and RF solutions

## Table of contents

Introduction.....	2
Role of fiber in 5G.....	3
Planning.....	4
Installation and commissioning.....	4
Acceptance.....	4
Maintenance.....	4
What needs to be tested?.....	4
Fiber test.....	5
WDM (Wavelength Division Multiplexing).....	6
– WDM test.....	9
– Channel check.....	9
– WDM OTDR testing.....	10
– PON OTDR test: during fiber build/laying/construction.....	10
Optical power measurement: during network activation.....	12
Fiber monitoring.....	12
Fronthaul transport network.....	14
– Synchronization test.....	15
– FTN test.....	16
– GPS test (GPS signal/satellite coverage test).....	17
– PTP test (PTP timing error test).....	18
– Ethernet test.....	18
– Network performance test (OTN test).....	19
– Virtual network performance test.....	20
Radio network test.....	21
– RF characterization and conformance test.....	22
– 5G beam analysis.....	23
– 5G carrier aggregation (x8).....	23
– Persistent real-time spectrum validation.....	24
– 5G Coverage Analysis.....	24
Workforce and asset management.....	00
Conclusion.....	27

## Introduction

As 5G moves from a concept in the lab to deployment in the field, field engineers, technicians and installers are grappling with the many challenges of ensuring a successful deployment. Validating 5G in the lab is one thing, but scaling it to the field requires robust, efficient, and scalable [5G test](#) and verification solutions. As [5G technology](#) cuts across all aspects of the network, namely core, transport, radio access network (RAN), and the underlying fiber network that holds it all together, having field validation and assurance solutions that are efficient, easy to use, and versatile can help service providers successfully launch 5G technology while maintaining existing 4G infrastructure. Let's analyze some of the network changes introduced in 5G and its implications.

One of the major use cases for 5G is enhanced mobile broadband (eMBB), where tens of Gbps will be offered over the air interface. This high throughput requires network infrastructure to evolve from today's service level, which is driving service providers all around the world to upgrade their fiber infrastructure to support 5G traffic requirements. One key characteristic of 5G is that the same network that will deliver eMBB service will be nimble enough to also offer ultra-reliable low latency communications (uRLLC), which means that some of the transport and RF functions may be located at different locations possibly in a virtual fashion. Network function virtualization and network slicing enables operators to offer different applications and services on the same network, helping them deliver on the diverse use cases of 5G. However, this technology shift adds to the complexity of network deployment and management.

Some of the key 5G challenges can be summarized as follows:

1. New complex technologies (mmWave, next generation passive optical network (NGPON), adaptive antenna system, fronthaul functional splits, latency-optimized frame structure, virtualization and network slicing etc.)
2. Fiber and bearer infrastructure upgrade
3. Scale of upgrade (20 to 30 times the number of small cells)
4. Managing multiple RAN technologies
5. Skills gap to manage complex workflows
6. Managing CapEx and OpEx

As with every 3GPP technology, 5G will be spread over multiple releases. In the first phase of 5G, release 15, the non-standalone (NSA) option will be supported, allowing early adopters to use their 4G core with 3GPP NR radio to offer 5G service. The first phase of release 15 will be mostly about eMBB, uRLLC, and massive MIMO. Phase 2 of release 15 will enable standalone (SA) operation which will enable 5G service on the next generation core. Although network function virtualization and network slicing will be supported in phase 2 of release 15, it will be some time before we will see them implemented in the field. Release 16 and beyond, we will see enhancements to support industrial IoT, vehicle to everything (V2X), unlicensed bands, and higher spectrum (>52.6GHz), which will probably be commercially deployed at a later stage (beyond 2020).

## Role of fiber in 5G

Fiber receives little attention when it comes to 5G, but the reality is that for 5G to be successful, the wireline network infrastructure carrying 5G services will play a vital role. In most cases, the entire network will be made up of fiber. This is driving service providers to invest billions in new fiber deployments and/or upgrading the fiber infrastructure. Today's network infrastructure can't handle all the use cases of 5G, where gigabytes of data throughput, augmented reality, massive machine type communication, and connected cars etc. all must be supported on the same physical network with different SLA requirements of latency, throughput, and reliability. According to [Ericsson's microwave outlook report](#), including North East Asia, by 2023 close to two thirds of the backhaul will be fiber (see Figure 1).

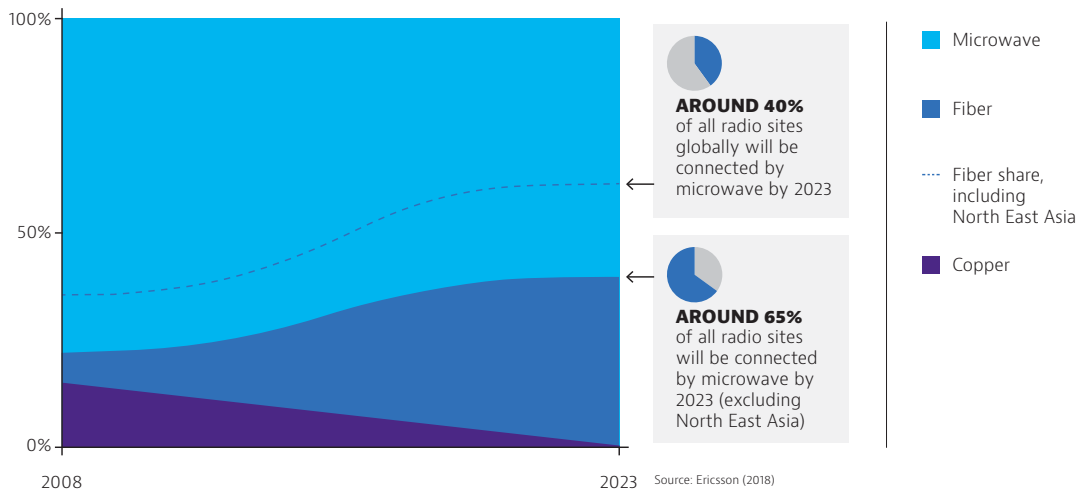

Figure 1: Global Backhaul media distribution

But all these fiber upgrades require operators to have resources with proper skills and test solutions to deploy and maintain the fiber infrastructure. Not doing so can significantly impact the quality of 5G services and will increase service providers' CapEx and OpEx. As shown in figure 2, all connections between the next generation core (NGC) at the data center to the 5G NR capable active antenna system (AAS) involve a fiber physical interface. Technologies employed to get to the AAS may vary, like NGPON, CWDM, DWDM, eCPRI, ORAN etc.; but the fundamental requirement to validate every fiber connection remains valid.

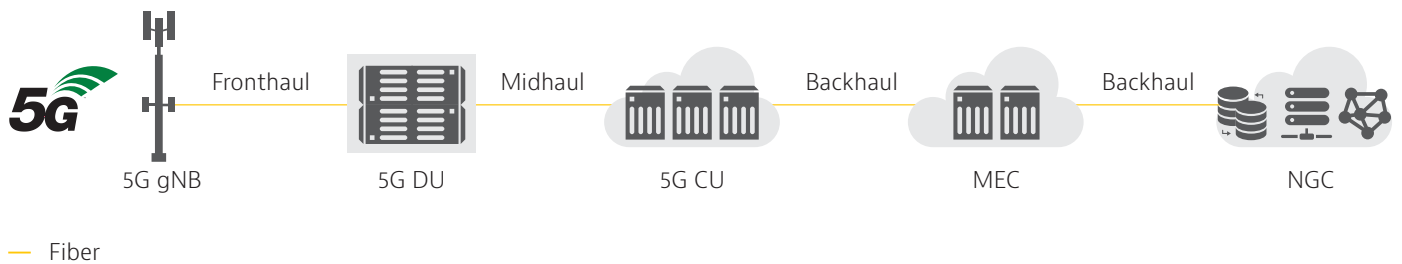

Figure 2 : Typical 5G Network Architecture



Figure 3: Typical 5G Network Architecture

The quality of the service offered by any network depends on certain actions performed during each stage of the network life cycle. From the point of inception of a network until the phase out, network operators are constantly engaged in ensuring their CapEx and OpEx investments are delivering the best return. It will be worthwhile to spend some time understanding the different stages of the network life cycle as shown in figure 3 and the actions required to make sure the network is delivering the best possible quality of service.

## **Planning**

Meticulous planning is the key to delivering a best-in-class wireless network. Identifying key coverage areas and capacity requirements at an application level helps service providers find the right solution and architecture for their networks. Network components and the infrastructure need to be designed to allow for future network growth and to deliver against target service level agreements (SLAs) and meet key performance indicators (KPIs).

## **Installation and commissioning**

In the implementation stage, when network components are installed, service providers and their vendors and contractors take great pains to make sure every physical interface (fiber, copper, and RF connections) is properly tested and validated before commissioning teams can validate call processing and service validation. Not doing so can result in excessive time to market (TTM) and revenue loss with significant OpEx spent in the future.

## **Acceptance**

Whether the whole network is launched at one time or a partial cluster, performing integration and acceptance tests are a must have before commercial traffic is deployed. Validating KPIs like throughput, dropped connections, access failure, handoffs, etc. are essential. In the case of an upgrade or new technology, interworking with the legacy network also needs to be validated. If any of the acceptance criteria requirements are not met, again commercial service and revenue topline will be negatively impacted.

## **Maintenance**

Post acceptance, service providers or managed service partners are responsible for the maintenance and assurance of the network. Any issues, whether hardware, software, or configuration related, need to be quickly isolated and fixed or network quality of service will suffer, resulting in customer churn. Quality of service truly depends on the rigor of test and measurement during the complete life cycle of the network.

## **What needs to be tested?**

As discussed earlier, whether SPs are deploying new technology or launching a greenfield network, all components, connections and the overall network needs to be tested. In this section we will talk about some of the key fiber, ethernet and RF tests that are essential for a successful and timely 5G launch, especially in regard to components and technologies that are either being upgraded or deployed for 5G.

## Fiber test

As part of 5G upgrades we expect to see more multi-fiber push on (MPO) connectors to be deployed in the field from regional datacenters all the way to the centralized RANs (C-RAN). Having the right tool to quickly inspect all the fibers of an [MPO connector](#) in a matter of seconds is now more important than ever because of the scale of deployment.

### 1. Fiber Inspection:

Contaminated connectors are a leading cause of problems in fiber optic networks. A single particle mated into the core of a fiber can cause significant back reflection, insertion loss, and even equipment damage. Operators should follow the ["Inspect Before You Connect"](#) process to ensure fiber end faces are clean prior to mating connectors.

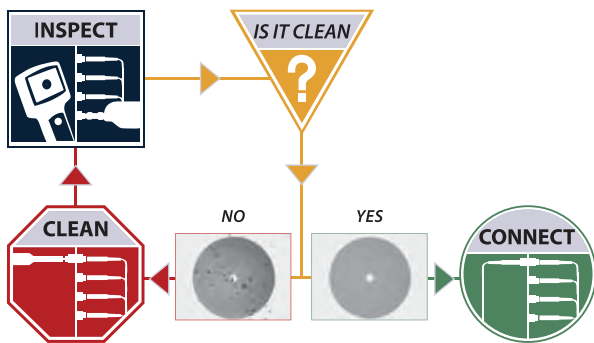

Figure 4: Inspect Before You Connect process



Figure 5: VIAVI FiberChek Probe and Sidewinder

### 2. OTDR Test:

An [optical time-domain reflectometer](#) (OTDR) allows technicians to detect, locate, and measure events on fiber links such as mated connectors, splices, bends, ends and breaks, and the following properties can be measured by having access to only one end of the fiber (unidirectional testing):

- Attenuation – The optical power or signal loss or the rate of loss between two points along the fiber span.
- Event Loss – The difference in the optical power level before and after an event.
- Reflectance – The ratio of reflected power to incident power of an event.
- Optical Return Loss (ORL) – The ratio of the reflected power to the incident power for an optical link.

The VIAVI [SmartOTDR](#) allows technicians at any skill level to perform all essential fiber tests. The Smart Link Mapper (SLM) application displays each event as an icon, giving technicians a schematic view of the entire link, helping them use an OTDR more effectively, without the need to be able to interpret and understand OTDR trace based results.

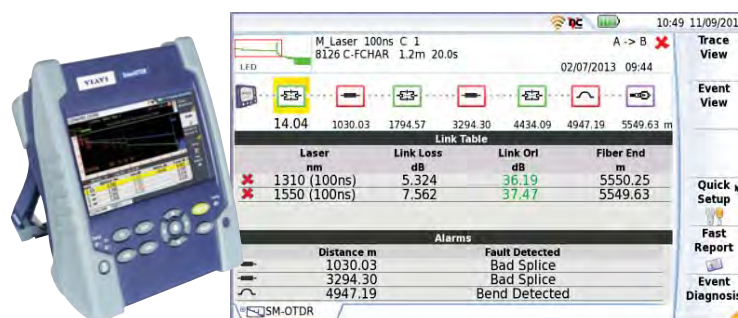

Figure 6: SmartOTDR and SmartLinkMapper application

In order to more accurately characterize fiber links and individual events, and to try to uncover additional events that may have been concealed by an OTDR's own dead zone performance when testing unidirectionally, dark fiber providers or the fiber owner/operator can perform [bi-directional tests](#). This allows for more accurate measurement of events (losses and reflections, etc.), and to confirm they are the same in both directions, there are situations due to fiber tolerances, mismatches or splicing that can result in excessive or differing optical losses (or apparent gains) when viewed from different directions.

Keep in mind you can never be 100% sure what direction of service a fiber will be used for when it is installed. A lot of applications are dual fiber with one Tx and one Rx fiber, but there are also single fiber implementations with different wavelengths being used for Tx and Rx on the same fiber in opposite directions.

VIavi [FiberComplete™](#) is an all-in-one, automated and single test port solution that tests bi-directional insertion loss (IL), optical return loss (ORL), and OTDR.

### Bidirectional Analysis

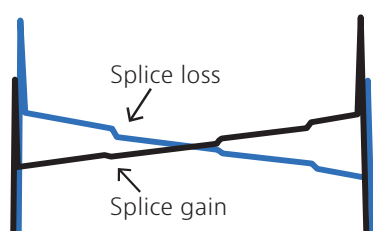

Fiber backscatter coefficient mismatches can cause a splice to appear as a gain or as a loss, depending upon the test direction.

Bidirectional analysis is used to minimize possible mismatches by measuring the splice loss in both directions and averaging the result to obtain the true splice loss.

Figure 7: FiberComplete application

## WDM (Wavelength Division Multiplexing)

WDM allows service providers to increase capacity by adding new equipment at either end of a fiber strand and combine multiple wavelength/channels on a single fiber strand. Multiplexers are used to combine wavelengths onto a single fiber, and demultiplexers are used to separate the wavelengths at the other end. There are four main technologies employed:

- 1. Coarse Wave Division Multiplexing (CWDM)**, provides up to 18 channels (or wavelengths) on a single fiber to allow for higher capacity. CWDM networks are typically passive with no active amplifiers in order to save cost and complexity and due to the wider channel spacings it can utilize cheaper components (SPF transceiver Tx/Rx, MUX/DeMUX and filters) which again makes it cheaper to deploy. Keep in mind that a key driver for access networks is price/cost. In addition, with only 18 channels it's easier to manage and maintain (there are only 18 variations of SFP to manage during deployment and maintenance). Passive CWDM is typically only used for distances up to 80km, however, for distances between 40 to 80km there can be a reduction in the number of usable channels to only the upper 8, this is because of the fiber's attenuation of wavelengths below 1470nm due to things like water peaks. The losses per wavelength across all the transmission bands are known as the fiber's attenuation profile (AP). The AP varies between fibers and fiber types and will partially dictate the number of useable channels which will have an impact on capacity scalability. Low water peak fiber has been available for some time but unless you are certain about the fiber in the ducts it is best to check. Ultimately for passive links the optical budget of the transceivers, passive element losses, splice/connector losses and the fiber's AP (i.e. optical loss per wavelength per km) will define the max link length achievable.

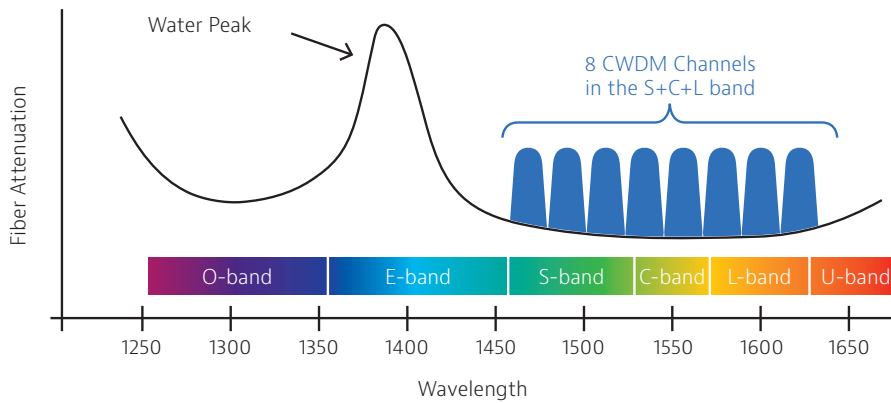

Figure 8: CDWM channels in the S + C + L band

**2. Dense Wave Division Multiplexing (DWDM)**, provides up to 96 channels per fiber depending on the spacing used. Spacing of 100 GHz is still the most common, but today's DWDM systems can support 50 GHz (0.4 nm) and even 25 GHz spacing with up to 160 channels is possible. To put this in perspective, WDM has a spacing of 20 nm per channel. DWDM networks can be passive or active, which approach is used will depend mostly on the distances involved, current data requirements and future capacity need. As for passive WDM the maximum distance for passive DWDM will depend on the transceiver's optical budget and the fiber loss per km for each wavelength (its AP).

**3. Hybrid CWDM & DWDM (xWDM)**, provides the possibility to expand the capacity of CWDM infrastructure by using an appropriate CWDM channel to accommodate multiple DWDM wavelengths. In this hybrid environment, the DWDM wavelengths typically use 100GHz spacing, this is for two reasons, firstly to allow for small drifts in transmitted wavelengths so filtering doesn't impact other services and secondly to keep the cost of transceivers, filters, and MUX/DeMUX to a minimum allowing for the utilization of cheaper components with wider tolerances.

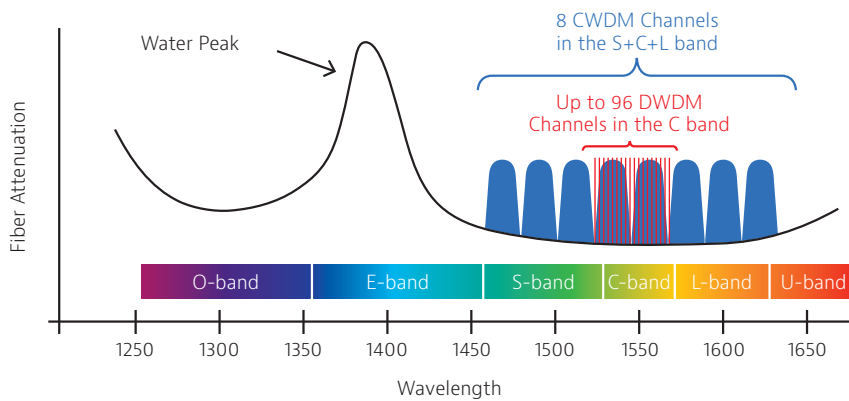

Figure 9: Hybrid CWDM and DWDM

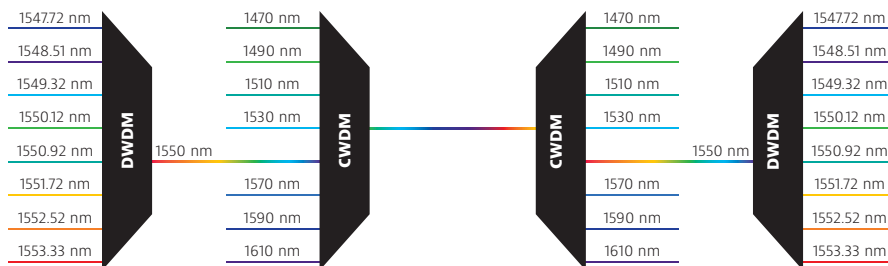

Figure 10: Example of 8 DWDM channels (100GHz spacing) added to an existing 8-channel CWDM network

4. **Passive Optical Network (PON)**, is a point to multi-point architecture using passive splitters to serve more end devices in the mid haul (Central Unit (CU) to Distribution Unit (DU)). Network architectures with single verses cascaded splitters are possible however, the actual split ratios will vary according to the distances involved and the optical loss budgets for transmitters/receivers (OLT/ONT).

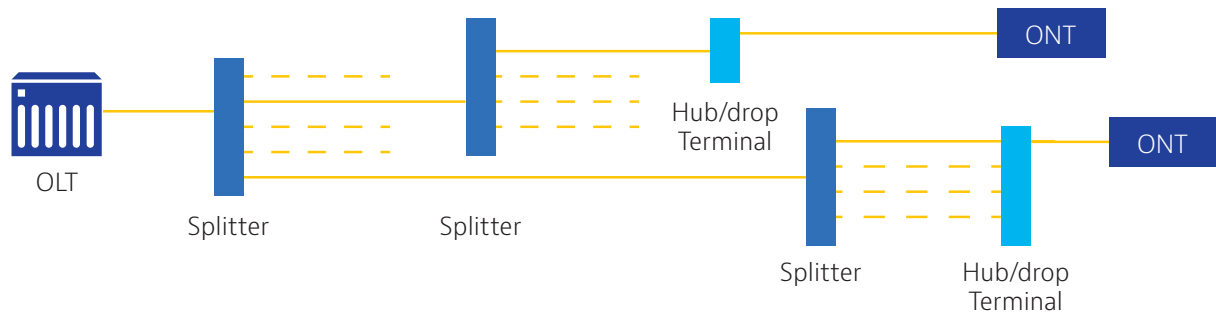

Figure 11: Cascade split PON architecture

Probably the biggest impact on split ratio will be down to the data capacity required for each DU and the PON standard used – keep in mind that PON services are shared services. As a rough example XGS-PON can deliver a symmetrical 10Gbps service, if each DU requires a fixed 1Gbps then a XGS-PON service can support 10 DU, so a 10-way split. In reality it is a little more complicated than that, you may be able to support more DU with an XGS-PON service once you consider average vs. peak data requirements per DU (plus headroom) and by using future PON features like Dynamic Bandwidth Allocation. Distances of between 40-60km can be achieved and newer PON standards like NG-PON2 can deliver a symmetrical 40Gbps capacity via use of multiple 10G wavelengths both up and downstream. This should suffice for the short to medium terms. Then based on what is seen with eCPRI (based on the capacity of the RF modulation schemes used) higher capacity PON standards, such as those being considered like 25G PON, with a single wavelength now delivering 25G instead of just 10G, will be needed in the medium to long term. PON also allows for some point-to-point WDM services.



## xWDM test

It is expected that most of the fiber network infrastructure will be upgraded to take advantage of higher multiplexing technologies to offer higher throughput. However, testing xWDM networks is not so trivial, especially since DWDM channels are so close, DWDM transmitters require precise temperature control to maintain wavelength stability and operate properly, and wavelength filters must do their job of passing the correct wavelength while blocking others. This means that an issue with one channel could easily create issues with the channels on either side, making testing and maintaining DWDM networks more complex. DWDM networks must be tested for loss, connector cleanliness, and spectral quality. The following tests are essential for xWDM networks.

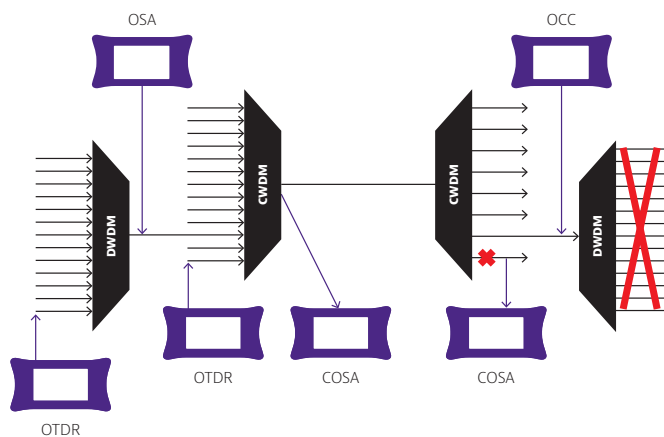

Figure 12: xDWDM testing

## Channel check

A CWDM or DWDM power meter (aka Optical Channel Checker (OCC)) such as the VIAVI OCC-55 (CWDM) and OCC-56C (DWDM) can be used to perform basic checks for wavelength presence and power levels to validate correct wavelength routing.



Figure 13: OCC-55

A small form factor CWDM or DWDM optical spectrum analyzer/optical channel checker, [COSA \(CWDM\)](#) and [OCC-4056C \(DWDM\)](#) 4100 series module for the T-BERD/MTS-2000, 4000, 4000 V2 and 5800 V2 mainframes, can also be used to perform the same wavelength presence and power level checks. However, with the added capability to report ITU-T channel numbers, technicians can quickly measure actual wavelength to check for drift or offset and report actual channel spacing (particularly important for DWDM). While dual integrated SFP bays allows technicians to verify wavelength/channel of colored and tunable SFPs which also provides the option to become a tunable light source which can be used for link routing/insertion loss test.

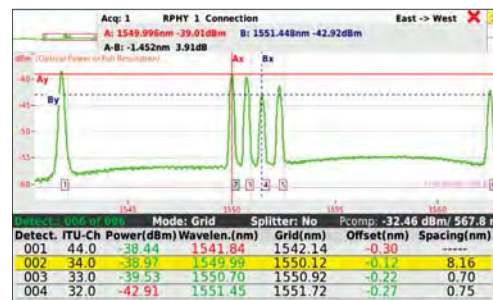

Figure 14: OCC-4056C DWDM Optical Channel Checker Module

## WDM OTDR test

A CWDM or DWDM OTDR such as the VIAVI 4100 series CWDM and DWDM OTDR modules, for the T-BERD/MTS-2000, 4000, 4000 V2 and 5800 V2 mainframes, can be used to validate a core fibers ability to transport all the xWDM wavelengths during build certification and prior to the connection of the WDM MUX/De-MUX. They can also be used after MUX/De-MUX connection to validate the end to end wavelength routing and losses for specific wavelengths or for maintenance and troubleshooting to expose and locate any bends, breaks, bad connectors or splices. Standard OTDRs using traditional 1310/1550nm wavelengths for test can't be used for this second level of testing due to the wavelength filtering implemented in the MUX/DeMUX devices.

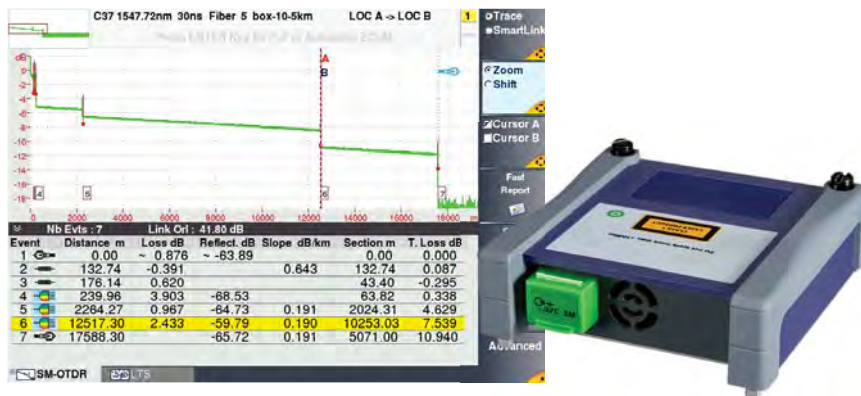

Figure 15: DWDM OTDR Module

## PON OTDR test: during fiber build/laying/construction

Prior to connecting to splitters, bi-directional certification of feeder fibers and distribution fibers for IL, ORL and length is a minimum requirement. Checking for, high loss connectors or bad splices requires OTDR testing and checking for bends requires OTDR testing at multiple wavelengths. Technicians should use a minimum of 2 wavelengths for bend detection, typically 1310 and 1550nm, preferably a third at 1625 or 1650nm as this improves bend detection and also gives technician a solution that can be used for in-service troubleshooting once the PON is activated, OTDR testing at 1490nm test yields no better results than 1550nm test ([see the white paper](#)). Additionally, certifying the longer wavelengths, such as 1625nm or 1650nm, future proofs the PON network for PON services like NG-PON2, where the longer wavelengths in the L-Band are far more susceptible to bending induced losses.

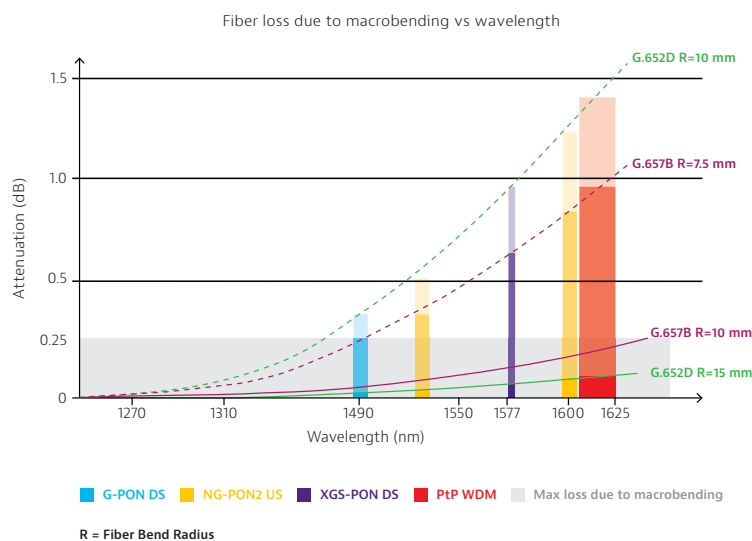

Figure 16: Bending losses – Wavelength vs Fiber Type for minimum bend radius

For improved accuracy of OTDR results, it is highly recommended to perform bi-directional tests. This allows technicians to identify potential faults that might be hidden by OTDR dead zones. Bi-directional tests will certify fiber performance in both directions (remember PON fibers carry light in 2 directions, up and downstream). Automation of the bi-directional testing and reporting process, presenting results in an easier to read format (Smart Link Mapper), along with performing tests via a single test port will significantly reduce test time, improve test workflow and reduce complexity (i.e. the risk of mistakes and re-test). VIAVI FiberComplete solution automates bi-directional IL, ORL and OTDR fiber certification.



Figure 17: FiberComplete for T-BERD/MTS-2000, -4000 V2, -5800 V2

After connection of splitters, OTDR certification is required to confirm final PON build. Technicians are required to check total end-to-end losses including splitter losses. This is typically carried out uni-directionally from the ONT (Optical Network Terminal)/ONU (Optical Network Unit) side of the network, looking back towards the local or central office, using an OTDR which utilizes a multiple pulse acquisition technique coupled with a dedicated PON/FTTx test application in order to test through splitters (single or cascaded) and characterize all sections of the PON. A single FiberComplete unit with the FTTH-SLM application OR a SmartOTDR with the FTTH-SLM application has these capabilities.



Figure 18: SmartOTDR

The Smart Link Mapper (SLM) application displays each event as an icon, giving technicians a schematic view of the entire link, helping them use an OTDR more effectively, without the need to be able to interpret and understand OTDR trace based results. The dedicated SLM version for FTTH/PON uses specific naming, labels, and icons unique to PON environments.

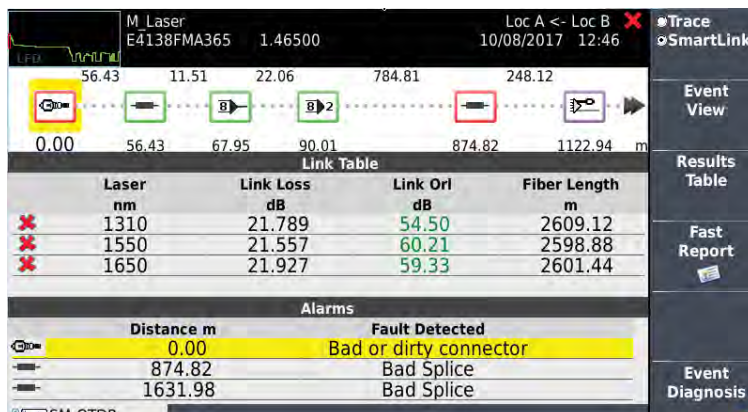

Figure 19: FTTH-SLM

### Optical power measurement: during network activation

As part of PON network activation technicians must validate that downstream and upstream optical power levels are within expected ranges prior to final connection of ONT/Cell/Radio. For 5G it's anticipated that XGS-PON and then NG-PON2 will be adopted while future standards such as 25G-PON are considered by the ITU-T and IEEE standards groups. For G-PON and XGS-PON or NG-PON2 the [OLP-87 PON power meter](#) can perform wavelength selective power level measurement. It also supports through mode operation and upstream burst mode measurement enabling both upstream and downstream power level measurements. It also helps in validating the ONT/ONU device by checking if the device is active and responding to the PON network equipment (OLT (Optical Line Terminal)).



Figure 20: OLP-87 G & XGS-PON or NG-PON2 Selective PON power meter

### Fiber monitoring

As discussed earlier, PON and its variations will be used in fiber infrastructure for 5G, and as the scale of PON network will increase so will the demand for troubleshooting and maintenance. Automating physical layer tests of a PON system from a centralized location such as a mobile telephone switching office (MTSO) can reduce provisioning time and maintenance cost and can improve network quality of service. As discussed earlier, an OTDR can pinpoint the location of faults in a fiber link and certify the workmanship involved in an installation. VIAVI ONMSi ([Optical Network Monitoring System](#)) can test and certify PON during the build and construction phase and then switch to on-going monitoring for multiple PON networks during their operational phase. ONMSi allows a single technician to test the network during installation. After service activation, the system accurately detects and locates fiber infrastructure degradation, alerting operators and managers with the details of faults.

With more and more fiber getting deployed, service providers are seeing a service activation failure rate of 25-30% due to improper installation of optical distribution networks (high loss splices/connectors/splitters, macrobends, wrong splitter/port connection, etc.). With this in mind, a fiber monitoring capability maximizes responsiveness to fiber-induced failures and resulting network outages.

VIAVI ONMSi enables continuous 24x7 monitoring, detection, and localization of faults based on OTDR traces comparison. Notifications are generated by SNMP/SMS/email with attachments of OTDR traces with geo-location on Optical Fiber Mapping (OFM) or external GIS for selected FTTx topologies. ONMSi helps scale optical network deployment and maintenance. This solution can also be delivered as a point solution, SmartOTU, with all hardware and software installed in a single chassis.

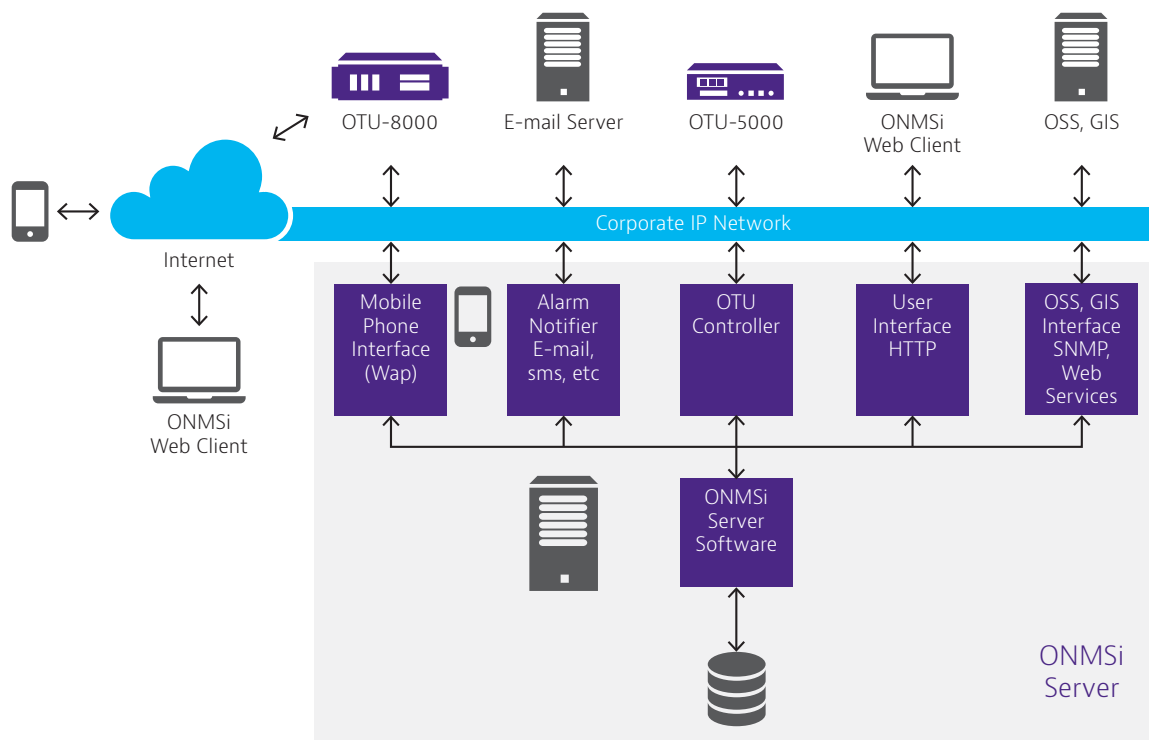

Figure 21: ONMSi solution architecture



Figure 22 : Dashboard and link schematic view



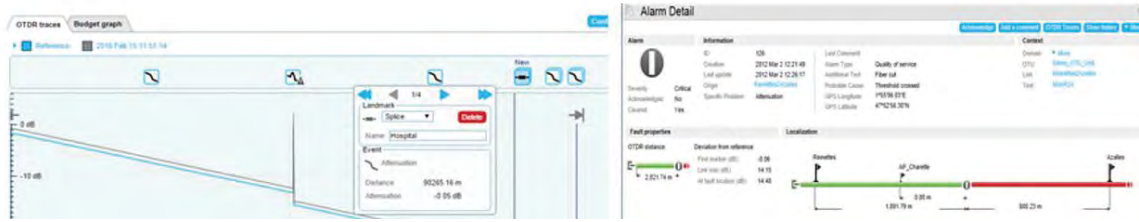

Figure 23 : OTDR detailed trace view and SLM view

## Fronthaul transport network

Today, common public radio interface (CPRI) provides dedicated transport protocols specifically designed to transport radio waveforms between the RRU and BBU. CPRI frames expand with increased radio channel bandwidth and number of antenna elements. CPRI is not very efficient in statistical multiplexing and cannot scale to the demands of 5G. Ethernet as a transport medium is very appealing, as it can allow for backwards compatibility with CPRI and other new packet technologies like eCPRI and ORAN. However, synchronization can be challenging. GPS, precision time protocol (PTP), synchronous Ethernet, or something similar can be used to overcome this challenge. Standards bodies are working to deliver new requirements to manage this issue for the different traffic types of 5G. Using ethernet for transport makes a lot of sense as it can be backwards compatible, allowing for commodity equipment, enabling greater convergence of access networks, and enabling statistical multiplexing, which will help lower the aggregate bit-rate requirements. Use of standard IP/Ethernet network switching/routing will also make functional virtualization and overall network orchestration easy.

Network slicing and network function virtualization (NFV) allows operators to offer different categories of services with a wide range of service requirements on a common, shared physical network. It also enables different splits for the digital and radio functions to be placed at different geographic locations.

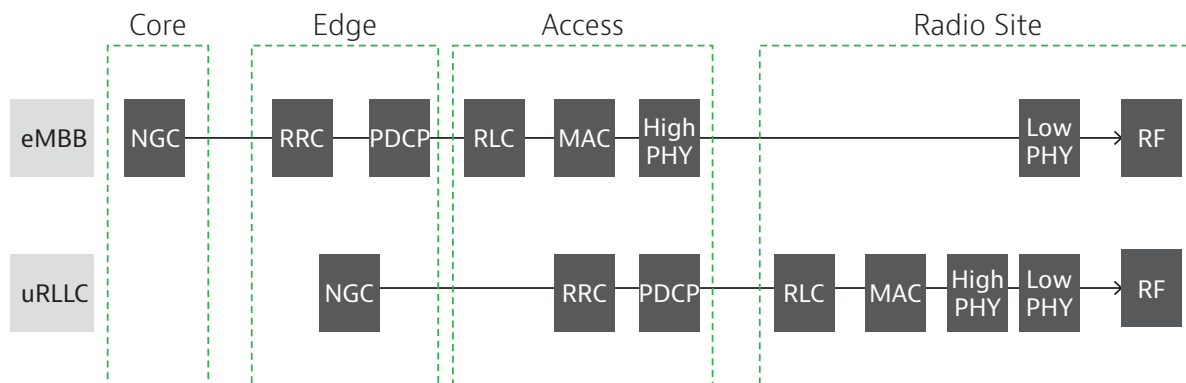
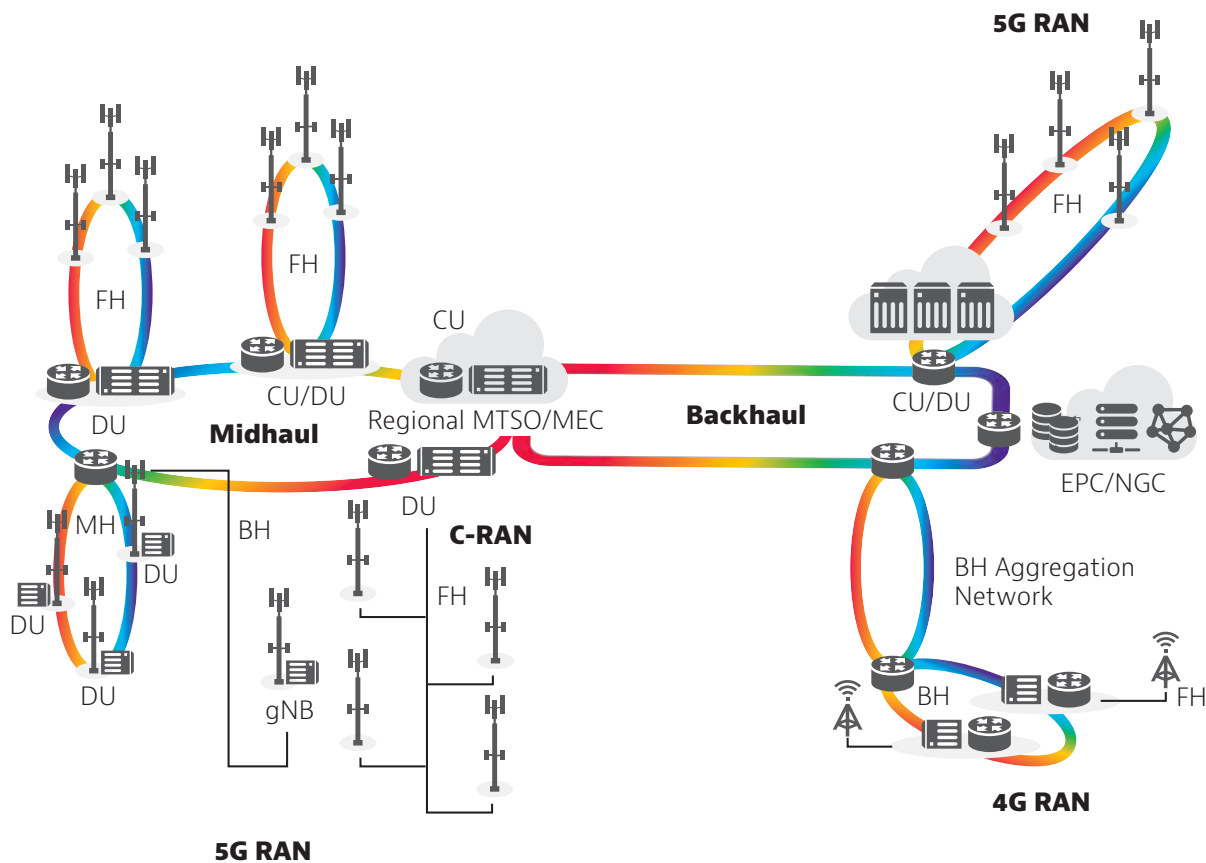

Figure 24: Network slicing for eMBB and uRLLC applications

Figure 24 illustrates an example of deploying one physical network to serve an eMBB and ultra-low-latency application at the same time. Whereas the former necessitates the use of a double split (options 2 and 7) architecture between the 5G core (NGC) and antenna, the latter needs to place the core functions closer to the edge to meet the tight latency requirements. This flexible architecture will demand a flexible fronthaul network which can support multiple types of traffic with different latency requirements and protocol functions that can be moved close to or away from the radio depending on the bandwidth requirements and latency budget. The topology of the network where CU and DU functions reside will vary by SP and applications they offer.



#### **Fronthaul DU-RU**

- CPRI/eCPRI/ORAN
- Range <20kM
- Latency micro seconds

#### **Midhaul CU-DU**

- F1 Interface
- Range <80kM
- Latency low milliseconds

#### **Backhaul CU-Packet Core**

- S1 Interface for 4G
- N1, N2, and N3 for 5G
- Range <200kM
- Latency tens of milliseconds

Figure 25: x-haul evolution

### **Synchronization test**

As discussed earlier, timing and synchronization plays a vital role in the performance of a wireless network. In 5G, those requirements are further enhanced due to phase and timing demands on networks based on time division duplex (TDD) and coordinated radio techniques. Previous mobile networks primarily required frequency synchronization to align signals, frequency sync alone will not be sufficient with 5G.

Synchronization requirements are derived from several bodies, including the 3rd Generation Partnership Project (3GPP). 3GPP technical specifications 36.104/38.104 represent two key documents that describe base station radio transmission and reception requirements. More specifically, section 6.5 (Transmit signal quality) lists several requirements that are essential for synchronization network design including time alignment error (TAE). TAE is defined as the largest timing difference between any two signals belonging to different antennas or transmitter groups. The requirements are categorized depending on the wireless use case (Table 1). These use cases are assigned unique categories from A+ to A, B, and C. The use cases at the bottom of the table are being developed at this time and have not been assigned a category.

3GPP Feature	RAN	
	LTE	NR
MIMO or TX-diversity transmission	Category A+	Category A+
Intra-band contiguous carrier aggregation	Category A	BS Type 1: Category B BS Type 2: Category A
Intra-band non-contiguous carrier aggregation	Category B	Category C
Inter-band carrier aggregation	Category B	Category C
TDD	Category C	Category C
Dual Connectivity	Category C	Category C
COMP	Not specified in 3GPP	Not ready in 3GPP
Supplementary Uplink	Not applicable for LTE	Not ready in 3GPP
In-band Spectrum Sharing	Not ready in 3GPP	Not ready in 3GPP
Positioning	Not specified in 3GPP	Not ready in 3GPP
MBSFN	Not specified in 3GPP	Not ready in 3GPP

Table 1: Timing Accuracy categories (eCPRI Transport Requirements)

Category A+ demands the most stringent synchronization requirements (Table 2); category C's requirement is in line with current LTE backhaul networks. The requirements are identified in terms of relative and absolute Time Error (TE). The relative TE specifies the time error between any two RU (or eRE). Absolute TE is the time error against a reference Primary Reference Time Clock (PRTC). In most cases the absolute TE requirements are in addition to the one for respective relative TE requirements (categories A+, A, and B).

Category	Time Error
A+ (relative)	20-32 ns
A (relative)	60-70 ns
B (relative)	100-200 ns
C (absolute)	1100 ns

Table 2: Time Error requirements

### FTN test

A fronthaul transport network node (FTN) is introduced to manage the ethernet access ring that can deliver a converged fronthaul supporting legacy CPRI and 5G eCPRI as shown in figure 26.

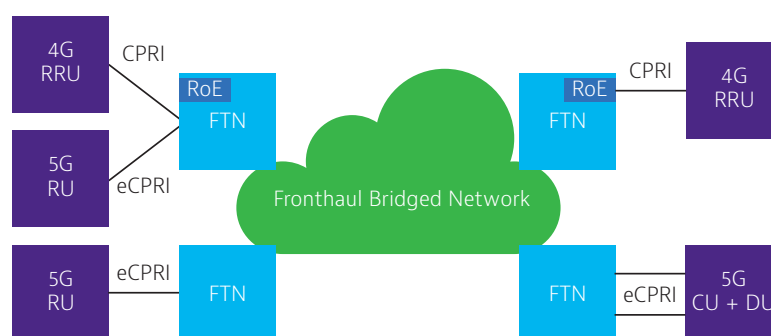

Figure 26: FTN Network architecture



This resolves some topology challenges, but it is important to make sure that FTN networks are not creating any excessive delays and are meeting the delay and synchronization budgets for the access network. Some of the eCPRI transport requirements are explained in the table below.

Cos Name	Example Use	One way maximum packet delay	One-way packet loss ratio
High	User Plane	100 $\mu$ s	$10^{-7}$
Medium	User Plane (slow), C&M Plane (fast)	1 ms	$10^{-7}$
Low	C&M Plane	100 ms	$10^{-6}$

Table 3: Split E and splits I<sub>v</sub>, II<sub>v</sub>, I<sub>u</sub> requirements

VIavi [T-BERD/MTS-5800 \(100G\)](#) can perform eCPRI tests, and can help measure throughput, delay, and packet jitter. Engineers can configure eCPRI message types according to eCPRI specification, measure bandwidth for each message type, and measure round trip delay (RTD) with sub 5 ns accuracy. By performing FTN tests, engineers can validate the delay and synchronization requirements for the FTN and can ensure it is within the designed network specifications.

VIavi T-BERD/MTS can perform the following tests for 5G fronthaul networks:

- Generate and analyze eCPRI signals (10/25GE)
- Generate/filter eCPRI subheaders
- One Way Delay Measurement
- C&M, SNMP/UDP/TCP test
- Test PTP/SyncE/GPS for synchronization
  - Emulate PTP Slave/master
  - Measure Time Error, Wander, PDV, MTIE/TDEV
  - GPS Signal Strengths, Trails
- Test Ethernet OAM (Loopback, LoC, Trace)

#### GPS test (GPS signal/satellite coverage test)

It is important to check GPS signal stability and suitability for the GPS antenna location at the time of installation, and periodically after installation as conditions around the site may have changed. VIavi T-BERD/MTS-5800 tests GPS signals using an integrated GPS receiver and provides the following results:

- Number of visible satellites
- Signal strengths
- CNO map spectrogram plots line of sight to satellites as they move around the orbit over time

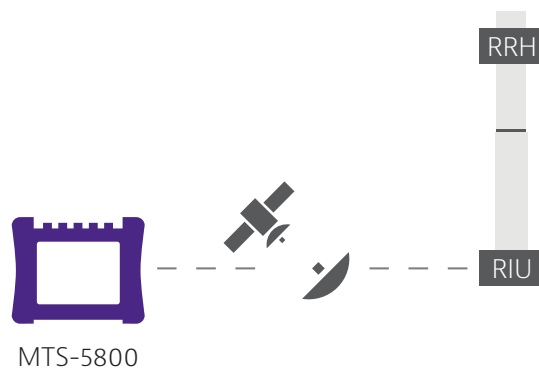

Figure 27: GPS Test using VIAVI T-BERD/MTS-5800

### PTP test (PTP timing error test)

As discussed earlier, wireless service is dependent on reliable synchronization. For PTP to reliably work, the PTP slave (RIU) needs to be able to connect to its assigned PTP grand-master and comply to PTP frequency profile network limits such as floor packet percentile. Additionally, PTP time/phase profile, needs to conform to the time error network limits. Using a VIAVI T-BERD/MTS, which works as a PTP slave, an engineer can check connectivity to the PTP grand-master and check whether timing error is within requirements by using a step-by-step guide.

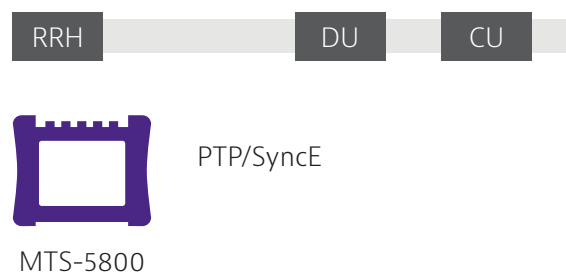

Figure 28: PTP Check using VIAVI T-BERD/MTS-5800

### Ethernet test

Validate performance of the backhaul network from the core to the virtual central unit (vCU) to ensure correct configuration and high-quality transport of data-plane and control-plane. RFC 2544 and Y.1564 test methodologies validate end-to-end configuration at either the Ethernet or IP level and ensure that the key performance objectives such as committed burst size (CBS), committed information rate (CIR), latency, packet jitter, and frame loss are met. Network operators can select either RFC 2544 or Y.1564 to test a single service or select Y.1564 to test multiple classes of service.

Tests can be performed in a single-ended or dual-ended test topology. The latter requires two test units but can ensure proper characterization of network in both directions and can detect potential asymmetries between the two directions. One-way delay measurement can also be performed to identify asymmetries caused by network equipment, components or fiber lengths. VIAVI T-BERD/MTS-5800-100G provides the following 2-port testing up to 100G:

- Throughput/one-way and loopback latency/frame loss/jitter
- RFC2544 testing
- Y.1564 testing

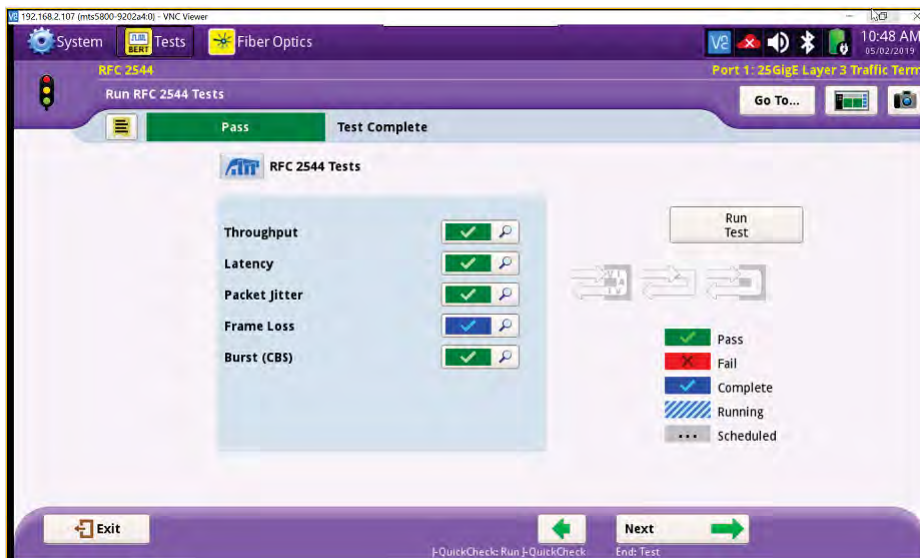

Figure 29: T-BERD/MTS-5800 easy to use RFC2544 Testing

### Network performance test (Optical Transport Network (OTN) test)

International Telecommunication Union (ITU)-T standards defines the following four tests for OTN.

- Payload bit error rate
- Latency/round trip delay
- General Communication Channel (GCC) transparency
- Service disruption

FAS			MFAS	SM	GCC0	RES	OPUK OH
RES	PM & TCM	TCM ACT	TCM6	TCM5	TCM4	FTFL	
TCM3	TCM2	TCM1	PM	EXP			
GCC1	GCC2	APS/PCC	RES				

Figure 30: OTN Overhead

VIAVI T-BERD/MTS-5800 provides an OTN Check application which tests all of the above parameters, ensuring an engineer does not have to be an expert in OTN technology.

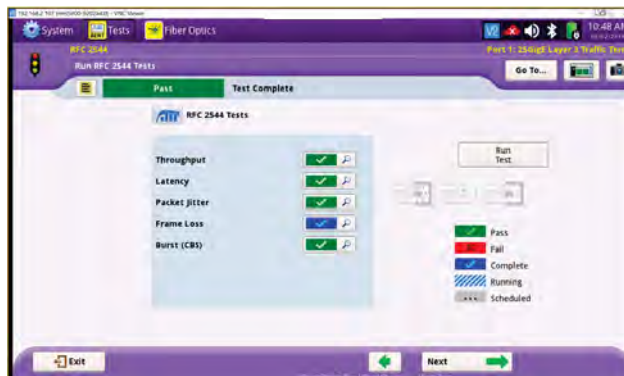

Figure 31: TBERD/MTS-5800 OTN Check application

## Virtual network performance test

With network function virtualization (NFV), the network is moving away from a hardware-centric, proprietary network infrastructure toward an open, standards-based, software model that is revolutionizing the way networks will be designed, implemented and operated.

VIAVI [NITRO vNet Fusion](#) combines software-based agents with standards-based (RFC7594) data collection methodologies to enable operators to leverage the non-proprietary compute platforms they're already deploying (for virtual network functions).

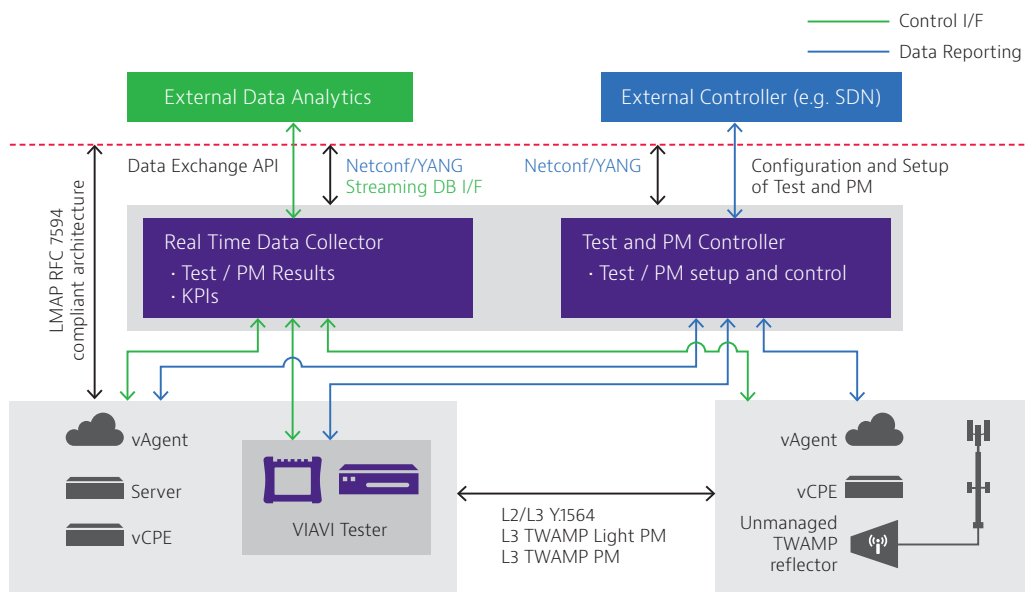

Figure 32: Fusion Architecture

With the Fusion virtual solution, operators can add virtual test and performance monitoring probes to their networks whenever and wherever required. At the same time, they can leverage VIAVI physical test sets and HW test probes for high performance testing.

Virtual probes running on x86 servers or compute platforms comprise the foundation of the solution by providing test functionality for network layers 2-4. Using Y:1564 / RFC6349 technologies, Fusion measures network performance and throughput and evaluates overall network quality. Fusion is also capable of monitoring a live service using two-way active measurement protocol (TWAMP).

## Radio network testing

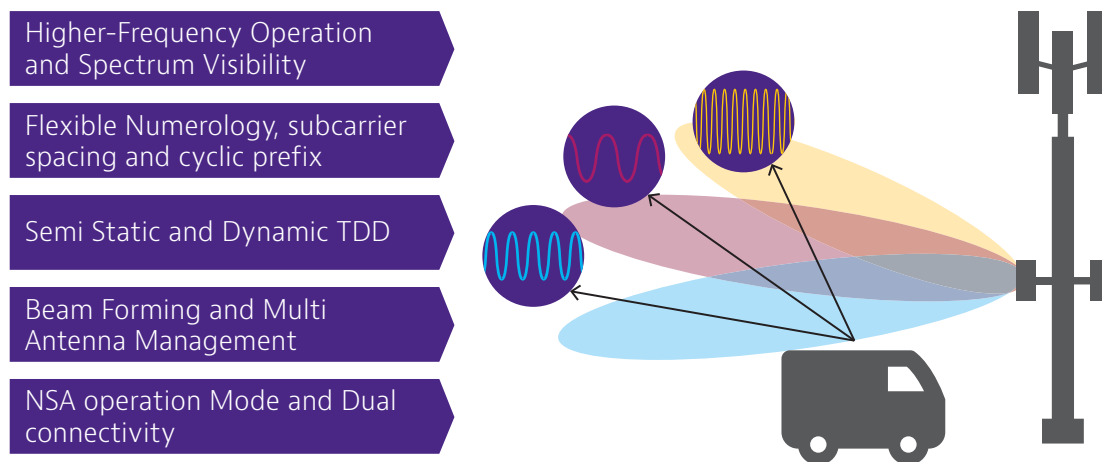

Figure 33: 5G RAN Evolution

5G NR is the new air interface which will be implemented in multiple phases and releases of 3GPP. As discussed earlier, 5G use cases such as eMBB, URLLC and mMTC can only be achieved through this new air interface, which has the following key characteristics:

1. Support for large bandwidth to deliver gigabit throughput (higher frequencies such as mmWave provides a very wide transmission bandwidth, 100s of MHz)
2. Joint operation in lower and upper band (complement propagation limited higher bands to be used for capacity while extending 5G coverage by using lower bands)
3. Massive MIMO to increase coverage especially in higher frequency bands by using beamforming.
4. Ultra-lean design to minimize always-on transmission, making the network and devices more efficient.
5. Flexible numerology with subcarrier spacing ranging from 15KHz to 240KHz which will follow a proportional change in cyclic prefix duration.
6. Mini slots transmission to support low latency and to preempt an ongoing slot-based transmission to another device, allowing for immediate transmission of data with very low latency.
7. Dynamic TDD, where (parts of) a slot can be dynamically allocated to either uplink or downlink as part of the scheduler decision to improve latency.

Where 5G radio enhancements will deliver a flexible tactile network, they will also create significant challenges for service providers to manage a wide array of complex technologies such as mmWave, massive MIMO, beam forming, and dual connectivity along with multiple applications with varying performance demands. We can all agree that the scale of the network will be much larger. From a service provider perspective, it will be essential to be able to scale resources to this ever-evolving network of networks. The traditional methods of service activation and network maintenance will not scale. Validating all these technologies with the right solutions during the installation and acceptance stages will be the key to successful and efficient network deployment.

## RF characterization and conformance test

RF characterization and conformance testing are the key to successful 5G network deployments. Ensuring 5G NR radios are behaving in accordance to 3GPP performance recommendations will help eliminate RF interference and radio performance issues. By validating the channel power, occupied bandwidth, adjacent channel leakage ratio, and spurious emission mask using a VIAVI [CellAdvisor™ 5G](#), technicians can quickly validate radio performance.

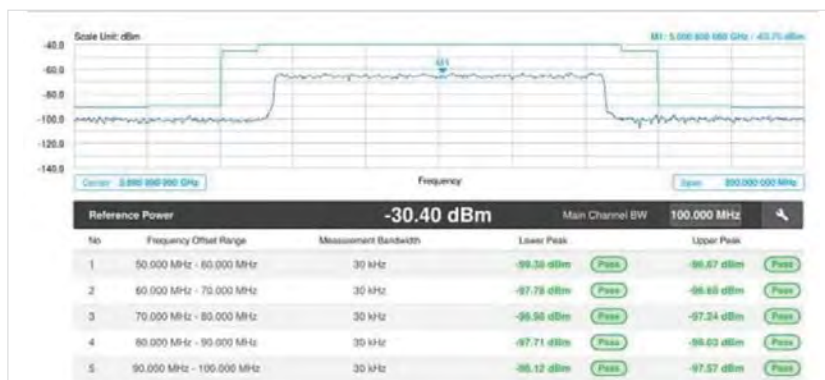

Figure 34: 5G conformance tests

## 5G beam analysis

Massive MIMO and antenna beamforming are the key technologies enabling 5G, which will change from static cell-centric coverage to dynamic user-based coverage for 5G radio access networks. Beamforming is the ability to generate and shape multiple beams using a much larger antenna array by manipulating the phase and amplitude of the arrays, thereby directing energy to a user's specific service area. At higher frequencies, millimeter wave (small wavelength) makes it easy to integrate a larger array into a relatively smaller form factor. Utilization of millimeter wave, which is essential for massive MIMO and beamforming, presents additional obstacles, as these frequencies are much more susceptible to propagation loss from environmental conditions. Validating over-the-air (OTA) performance is extremely important to ensure UE can perform beam tracking and switching in this challenging RF environment.

Validating beam performance is a challenge for operators who need to perform beam-centric radio planning and optimization and need to quickly troubleshoot and identify the root cause of poor massive MIMO and beamforming performance. CellAdvisor 5G allows engineers to easily validate beam performance and ensure that they are taking advantage of massive MIMO and beamforming.

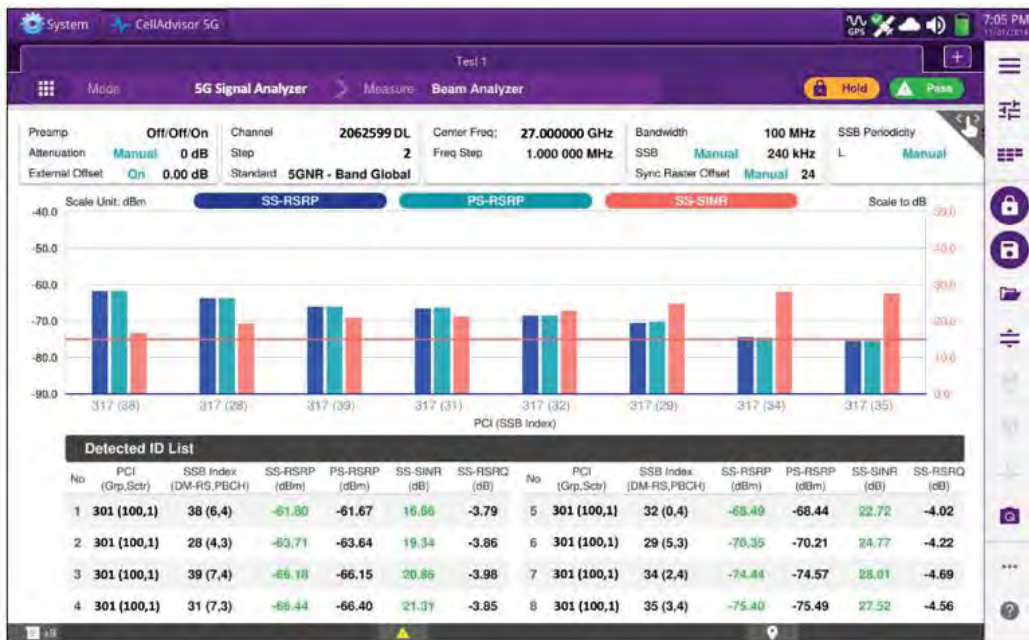

Figure 35: 5G Beam Analyzer (8 strongest beams)

## 5G carrier aggregation (x8)

The concept of carrier aggregation (CA) was introduced in LTE Release 10. Carrier aggregation refers to concatenation of multiple carriers. This increases bandwidth and consecutively the data rate of the system. 5G NR supports carrier aggregation with 16 component carriers (CCs). Carrier aggregation of LTE and 5G NR carriers is also possible; this is known as dual connectivity. CA is supported for both contiguous and non-contiguous CCs. In 5G NR Phase 1, up to 16 CCs are supported and carriers can use different numerologies (i.e. SCS, slots etc.).

Using a CellAdvisor 5G, RF engineers can validate spectral impairments in mmWave for eight aggregated carriers for a total bandwidth of 100MHz, it can also help in validating the radio's power performance across all carriers.



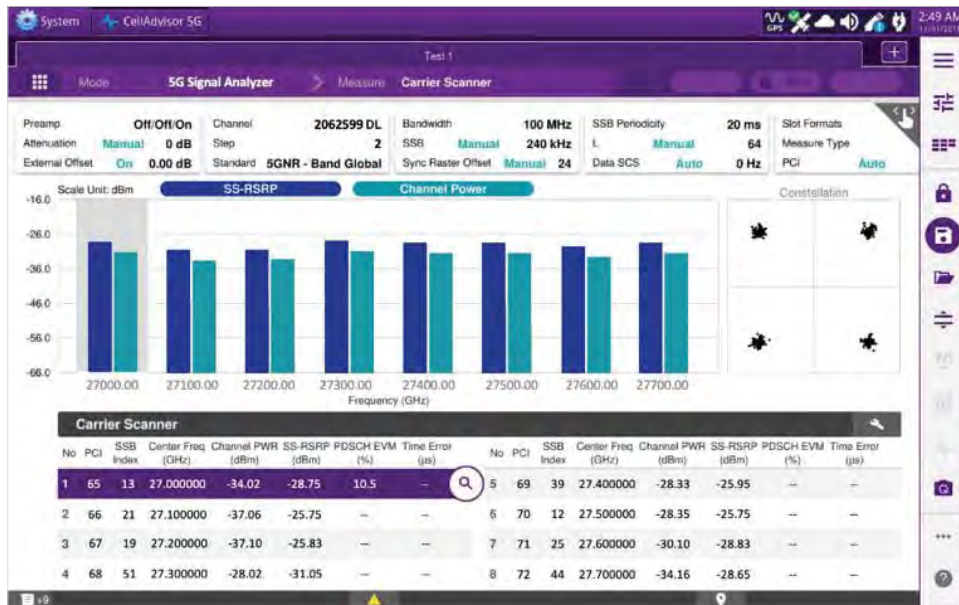

Figure 36: 5G Carrier Scanner (8 component carriers)

### Persistent real-time spectrum validation

The physical layer of 5G New Radio (NR) continues to use orthogonal frequency division multiplexing (OFDM); however, the duplexing options supported in NR include frequency division duplex (FDD), time division duplex (TDD) with semi-statically configured UL/DL configuration, and dynamic TDD. In the TDD scheme, both DL and UL use the same frequency but are allocated different time slots for transmission and reception. In that scenario, identifying an interference signal is extremely difficult when the base station is transmitting the signal in the DL. To overcome this challenge, a gated sweep functionality that only measures the signals during the UL transmission period is used. Gated sweep is essential for isolating interfering signals in the UL. However, as 5G NR introduces dynamic TDD where UL and DL transmissions can be changed dynamically, the gated sweep function will no longer be effective.

A real-time spectrum analyzer (RTSA) can overcome this challenge, as it can detect signal level and frequency of occurrence of rapidly changing interfering signals overlapped with the 5G NR signal. A real-time spectrum analyzer can capture transient and fast signals more quickly as well. Traditional spectrum analyzers perform data sampling and Fast Fourier Transform (FFT) processing in a serial manner, sweeping across the spectrum by capturing small parts of the spectrum at a time and building a complete picture over time. As a result of this serial process, a traditional spectrum analyzer is blind to other spectral regions during the sweep time. If an event (interfering signal) occurs in one part of the spectrum while a different part of the spectrum is being examined, the event will be missed. On the other hand, a real-time spectrum analyzer can perform the data sampling and FFT processing in parallel, and theoretically can capture every intermittent signal without missing any signals for the entire range of spectrum.

A real-time spectrum analyzer can process thousands to hundreds of thousands of spectrums per second, but the visually perceptible screen update rate is about 30 frames per second. To overcome this, a RTSA uses a viewing method called persistent spectrum display, which shows hundreds or thousands of spectrum data on a screen, but with a different color or brightness per frequency of occurrence to determine the probability of signals appearing rather than just the amplitude of a signal.



Persistent display effectively distinguishes UL traffic with all irregularities and interference signals with relatively high repeatability, thereby effectively detecting interference signals in the UL.

CellAdvisor 5G performs real-time spectrum and interference analysis with persistence for an entire 100MHz signal. By accumulating more than 15,000 traces on a screen with a color index representing the time duration and repetition rate of every signal, CellAdvisor 5G provides the optimal condition for identifying the signature of intermittent interference sources.



Fig 37: Persistent display showing interference signals in 2.4GHz band.

### 5G Coverage Analysis

CellAdvisor5G route map functionality provides a basic RF coverage map depicting service availability developed from a walk or drive test. Location is tracked through an integral GPS receiver and the heat map measurements are captured using a special omni-directional antenna system and the CellAdvisor 5G Beam Analyzer function. In addition to the continually updated display results, CellAdvisor 5G also captures a log file that can be exported to off-line coverage analysis tools. The 5G route map is used by field technicians to verify and measure:

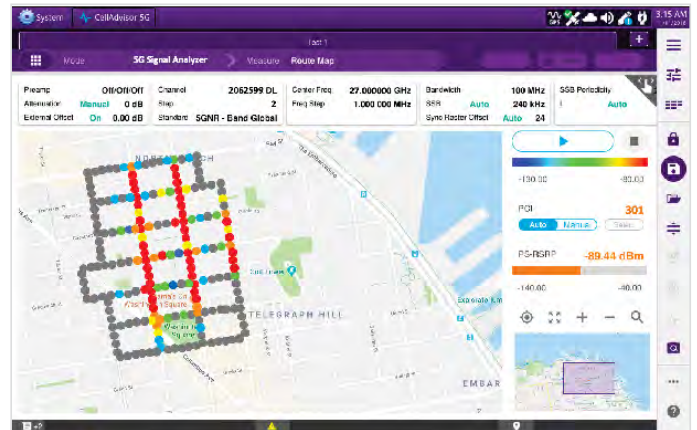

Fig 38: CellAdvisor 5G coverage map analysis

**Cell Coverage:** identifies the physical cell ID for each datapoint

**Beam Availability:** attributes the beam index for each datapoint

**Beam Propagation:** provides the measured beam power and beam Signal to Noise Ratio (SNR) at each datapoint

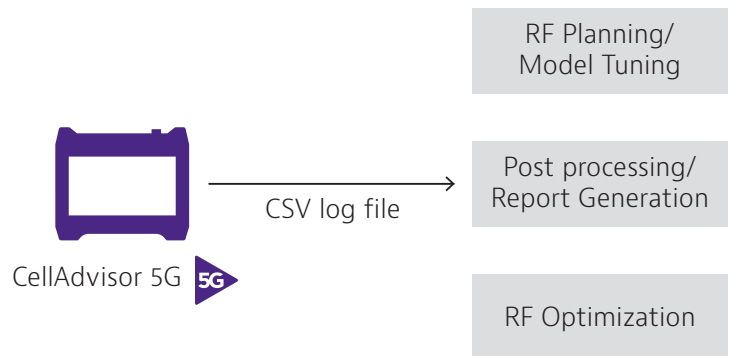

Fig 39: CellAdvisor 5G coverage map analysis

## Workforce and asset management

Networks upgrades are managed by SPs or network equipment manufacturers (NEMs) or the contractors supporting them. Agreed methods of procedure (MOPs) are used to ensure all aspects of network upgrade follow a standard process, utilizing approved instruments with correct software versions and delivery of reports in a standardized format. However, not all technicians are equal, and with the current spike in network upgrades and workload, technician turnover is significant. These challenges further add to the complexity of the overall network upgrade process. Time to market can be compromised if proper test procedures are not followed and test results are not delivered correctly or in a timely manner. VIAVI has been working with service providers to help them overcome these difficulties, and to minimize the chaos during upgrades and network management activities. Managing vendors, employees, and sub-contractors as one team with consistent procedures and test reporting is critical to allowing a flexible workforce and easy onboarding during an upgrade.

VIAVI [StrataSync™](#) is a cloud-enabled software solution that helps service providers empower their human and test-equipment assets to tackle the challenges of network testing in an efficient, effective manner. StrataSync provides asset management, configuration management, and test-data management of VIAVI instruments as well as asset tracking of non-VIAVI instruments. StrataSync gives service providers real-time visibility into their assets and test data with new levels of control and compliance monitoring, increasing the efficiency of testing and maintaining the network.

The following key features of StrataSync streamline the entire test process and help service providers and NEMs accelerate their workflow:

1. Job definition and assignment: Syncs job assignments to instruments to avoid manual hand-offs, lost job tickets and ill-prepared dispatches.
2. Test procedure implementation: MOPs are directly transferred to the instrument to make it easy for technicians to follow the test process and perform proper testing.
3. Real-time reporting with test data storage: Auto-collects and collates test reports and KPIs for faster network acceptance and issue resolution.
4. Test asset management: Avoids email inventories and lost test tools, and prevents buying excess tools.

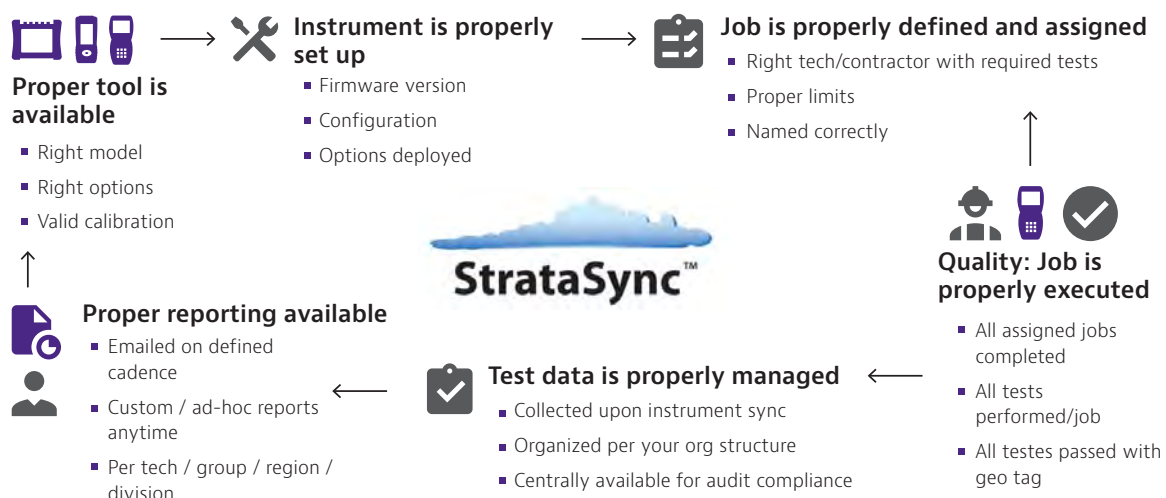

Fig 40: StrataSync Workflow

## Conclusion

Overall, there is an expectation that 5G will be an innovation platform that will foster an environment where new services become possible and can be brought to market quickly. This will empower service providers to take advantage of market opportunities and dynamically meet changing consumer and business needs. However, deploying and supporting 5G's complex technology and network architecture will not be a trivial exercise. Time-to-market and network quality will depend on the rigor of test and measurement during the complete life cycle of the network. VIAVI is the industry leader in test and measurement and is best positioned to deliver the [most comprehensive end to end network test solution](#). With the VIAVI fully-integrated portfolio of cloud-enabled instruments and systems, software automation, and services for network testing, performance optimization, and service assurance, operators and their partners can be assured of a smooth network roll-out and sustainable network lifecycle.

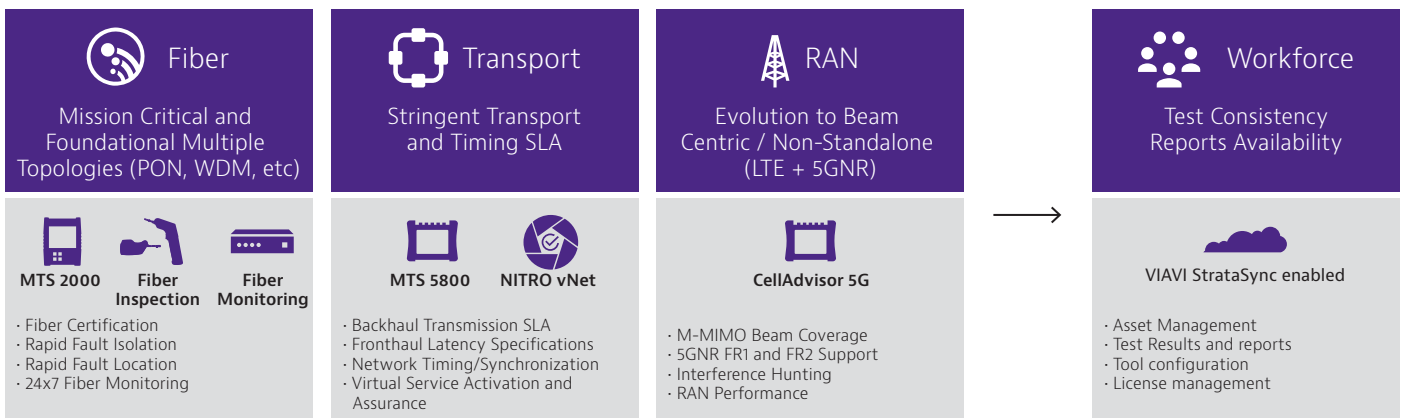
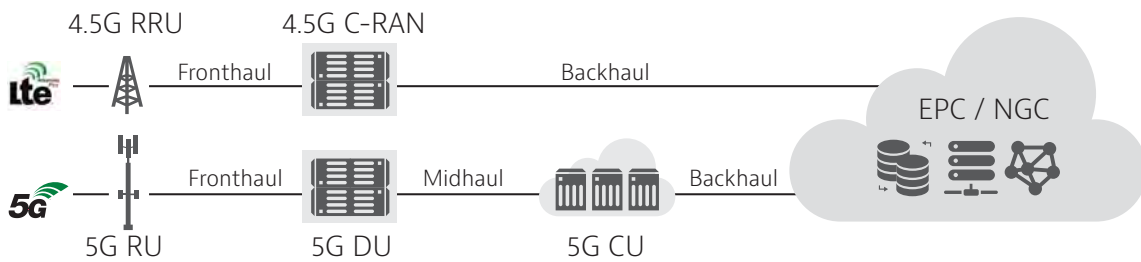

Figure 41: VIAVI network 5G service enablement solution

## Solution Guide

Solution	Description	5G Test Activities
VIAVI <b>FiberChek Probe</b>	Handheld device for fiber inspection and analysis	Fiber inspection
VIAVI <b>FiberChek Sidewinder</b>	"All-in-one" handheld inspection and analysis solution for multifiber connectors such as MPO	Fiber inspection (multifiber)
VIAVI <b>SmartOTDR</b>	Single device with optical time domain reflectometry measurement, fiber end face analysis, optical loss testing and visual fault locator	OTDR test
VIAVI <b>FiberComplete</b>	Automatic bi-directional insertion loss (IL), bi-directional optical return loss (ORL using OCWR method), distance and bi-directional OTDR or fault finder	Bi-directional testing to improve fiber link characterization
VIAVI <b>SmartClass OCC-55(CWDM)/OCC-56C (DWDM)</b>	CWDM optical channel checker/DWDM optical channel checker	Channel checking for presence and power
VIAVI <b>COSA-4055 (CWDM) and OCC-4056C (DWDM)</b>	CWDM optical spectrum analyzer/DWDM optical channel checker	Measure actual wavelength, offset and drift, and channel spacing
VIAVI <b>OLP-87 PON power meter</b>	FTTx/PON power meter for use in activating and troubleshooting B-PON, E-PON and G-PON and next generation high speed XGS-PON and NG-PON2	Optic power measurement during network activation
VIAVI <b>ONMSi</b>	Optical network remote test and monitoring system for core, metro, access and FTTH networks	<ul style="list-style-type: none"> <li>• Test and certify PON during build and construction phase</li> <li>• On-going monitoring of multiple PON networks during operational phase</li> </ul>
VIAVI <b>T-BERD/MTS-5800 (100G)</b>	Handheld dual-port 100G instrument for testing, service activation, troubleshooting, and maintenance	<ul style="list-style-type: none"> <li>• eCPRI test (throughput, delay, packet jitter)</li> <li>• Validate delay and synchronization requirements for the FTN</li> <li>• GPS test</li> <li>• PTP test (PTP timing error test)</li> <li>• Ethernet test (backhaul)</li> <li>• OTN test</li> </ul>
VIAVI <b>NITRO vNet Fusion</b>	Software-based lifecycle management for test, service activation, performance monitoring and troubleshooting	<ul style="list-style-type: none"> <li>• Virtualized test</li> <li>• Virtualized service activation</li> <li>• Virtualized performance monitoring</li> <li>• Virtualized troubleshooting</li> </ul>
VIAVI <b>CellAdvisor 5G</b>	Field portable base station analyzer for validating all aspects of 5G cell site deployment, maintenance, and management	<ul style="list-style-type: none"> <li>• RF characterization and conformance test</li> <li>• 5G beam analysis</li> <li>• 5G carrier aggregation (x8)</li> <li>• Persistent real-time spectrum validation</li> </ul>
VIAVI <b>StrataSync</b>	Cloud-enabled platform for asset management, configuration management, and test-data management of VIAVI instruments as well as asset tracking of non-VIAVI instruments	Management of vendors, employees and subcontractors as one team during all 5G network deployment activities

### For More Information:



### Vicom Australia

1064 Centre Rd  
Oakleigh South Vic 3167  
Australia  
1300 360 251  
info@vicom.com.au  
www.vicom.com.au

### Vicom New Zealand

Grd Floor, 60 Grafton Road  
Auckland 1010  
New Zealand  
+64 9 379 4596  
info@vicom.co.nz  
www.vicom.co.nz



VIAVI Solutions

viavisolutions.com

© 2019 VIAVI Solutions Inc.  
Product specifications and descriptions in this document are subject to change without notice.  
testguide5g-an-xfp-nse-ae  
30187792 901 0519