

## HotSwap MBP Maintenance Bypass

**MBP6Ki  
MBP11Ki  
MBP11Ki31**

**Installation  
and user manual**

Copyright © 2013 **EATON**  
All rights reserved.

**Service and support:**  
Call your local service representative

# SAFETY INSTRUCTIONS

**SAVE THESE INSTRUCTIONS.** This manual contains important instructions that should be followed during installation and maintenance of the MBP and UPS.

The HotSwap MBP models that are covered in this manual are intended for installation in an environment within 0 to 40°C, free of conductive contaminant.

This equipment has been tested and found to comply with Class A UPS, pursuant to Part 15 of the FCC Rules. These limits are designed to provide reasonable protection against harmful interference when the equipment is operated in a commercial environment. This equipment generates, uses, and can radiate radio frequency energy and, if not installed and used in accordance with the instruction manual, may cause harmful interference to radio communications. Operation of this equipment in a residential area is likely to cause harmful interference in which case the user will be required to correct the interference at his own expense.

## Certification standards (in use with UPS)

- Safety: IEC/EN 62040-1 / Ed.1: 2008.
- EMC: IEC 62040-2 / Ed.2: 2005  
EN 62040-2 / Ed.2: 2006.
- Performance: IEC/EN 62040-3 / Ed.2.0: 2011.
- IEC 61000-4-2 (ESD): level 3.
- IEC 61000-4-3 (Radiated field): level 3.
- IEC 61000-4-4 (EFT): level 4.
- IEC 61000-4-5 (Fast transients): level 4.
- IEC 61000-4-6 (Electromagnetic field): level 3.
- IEC 61000-4-8 (Conducted magnetic field): level 4.

## Special symbols

The following are examples of symbols used on the HotSwap MBP to alert you to important information:



**RISK OF ELECTRIC SHOCK** - Observe the warning associated with the risk of electric shock symbol.



Important instructions that must always be followed.



This symbol indicates that you should not discard waste electrical or electronic equipment (WEEE) in the trash. For proper disposal, contact your local recycling/reuse or hazardous waste center.



Information, advice, help.



Refer to the user manual of UPS.

## Safety of persons

- The system has its own power source when connected to the UPS (UPS battery). Consequently, the power outlets may be energized even if the system is disconnected from the AC power source. Dangerous voltage levels are present within the system. It should be opened exclusively by qualified service personnel.
- The product must be properly grounded, always connect the earth wire first

## Product safety

- The MBP connection instructions and operation described in the manual must be followed in the indicated order. Disconnection and overcurrent protection devices shall be provided by others for AC in/out circuits.
- CAUTION -To reduce the risk of fire, the unit connects only to a circuit provided with branch circuit overcurrent protection (please refer to the UPS User Manual for current rating). The upstream circuit breaker must be easily accessible. The unit can be disconnected from AC power source by opening this circuit breaker, and if still connected to UPS, by previously shutting down the UPS (refer to the UPS User Manual)
- Check that the indications on the rating plate correspond to your AC powered system and to the actual electrical consumption of all the equipment to be connected to the system.
- Never install the system near liquids or in an excessively damp environment.
- Never let a foreign body penetrate inside the system.
- Never expose the system to direct sunlight or source of heat.
- If the system must be stored prior to installation, storage must be in a dry place.
- The admissible storage temperature range is -15°C to +60°C.

## Special precautions

- The HotSwap MBP is designed to work with approved EATON UPS (contact your Eaton reseller for more information)
- All repairs and service should be performed by AUTHORIZED SERVICE PERSONNEL ONLY. There are NO USER SERVICEABLE PARTS inside the MBP.

# Contents

<b>1. Introduction.....</b>	<b>5</b>
1.1 Environmental protection .....	5
<b>2. Presentation.....</b>	<b>6</b>
2.1 Standard positions.....	6
2.2 Description / Panels.....	8
<b>3. Installation .....</b>	<b>9</b>
3.1 Inspecting the equipment.....	9
3.2 Unpacking the MBP.....	9
3.3 Checking the accessory kit.....	9
3.4 Mechanical Mounting.....	10
3.5 Installation requirements.....	10
<b>4. Power cables connection .....</b>	<b>11</b>
4.1 MBP6Ki.....	11
4.2 MBP11Ki / MBP11kI31 – with common Normal and Bypass AC source .....	12
4.3 MBP11Ki / MBP11kI31 – with separate Normal and Bypass AC source .....	13
<b>5. Operations.....</b>	<b>15</b>
5.1 UPS start-up with HotSwap MBP.....	15
5.2 UPS replacement with HotSwap MBP.....	16
5.3 UPS maintenance with HotSwap MBP .....	18
<b>6. Specifications.....</b>	<b>19</b>

Thank you for selecting an EATON product to protect your electrical equipment.

The HotSwap MBP range has been designed with the utmost care.

We recommend that you take the time to read this manual to take full advantage of the many features of your MBP (Maintenance Bypass).

Before installing your HotSwap MBP with your UPS, please read first the safety instructions.

Then follow the indications in this manual, which completes the UPS Installation and User Manual.

To discover the entire range of EATON products, we invite you to visit our web site at [www.eaton.com/powerquality](http://www.eaton.com/powerquality) or contact your EATON representative.

## 1.1 Environmental protection

EATON has implemented an environmental-protection policy. Products are developed according to an eco-design approach.

### Substances

This product does not contain CFCs, HCFCs or asbestos.

### Packing

To improve waste treatment and facilitate recycling, separate the various packing components.

- The cardboard we use comprises over 50% of recycled cardboard.
- Sacks and bags are made of polyethylene.
- Packing materials are recyclable and bear the appropriate identification symbol



Materials	Abbreviations	Number in the symbols 
Polyethylene terephthalat	PET	01
High-density polyethylene	HDPE	02
Polyvinyl chloride	PVC	03
Low-density polyethylene	LDPE	04
Polypropylene	PP	05
Polystyrene	PS	06

Follow all local regulations for the disposal of packing materials.

### End of life

EATON will process products at the end of their service life in compliance with local regulations. EATON works with companies in charge of collecting and eliminating our products at the end of their service life.

### Product

The product is made up of recyclable materials.

Dismantling and destruction must take place in compliance with all local regulations concerning waste. At the end of its service life, the product must be transported to a processing center for electrical and electronic waste.

## 2. Presentation

The Eaton® HotSwap MBP module makes it possible to service or even replace the UPS without affecting the connected loads (HotSwap function).

You can safely eliminate the effects of UPS maintenance and guard the integrity of your equipment. Providing outstanding reliability, the Eaton HotSwap MBP unique benefits include:

- Easy and fast connection to UPS due to Input/Output and signal "all in one" patented connector (Hotswap MBP 5/6kVA range)
- **"make before break"** feature to allow full servicing (electrical power continuity) when switching from UPS position to Bypass (and vice versa)
- Communication feature with UPS\*: detection of MBP connection and switch position (Normal or Bypass) (\* works only with some approved EATON UPS - contact your Eaton reseller for more information)
- Load connection by both terminal blocks and IEC outlets (10A C13 and/or 16A C19 following MBP versions)
- Adjustable 19" Rack kit and multiple positions Tower installation kit provided
- Backed by worldwide agency approvals.

### 2.1 Standard positions

#### MBP6Ki

##### Tower installation

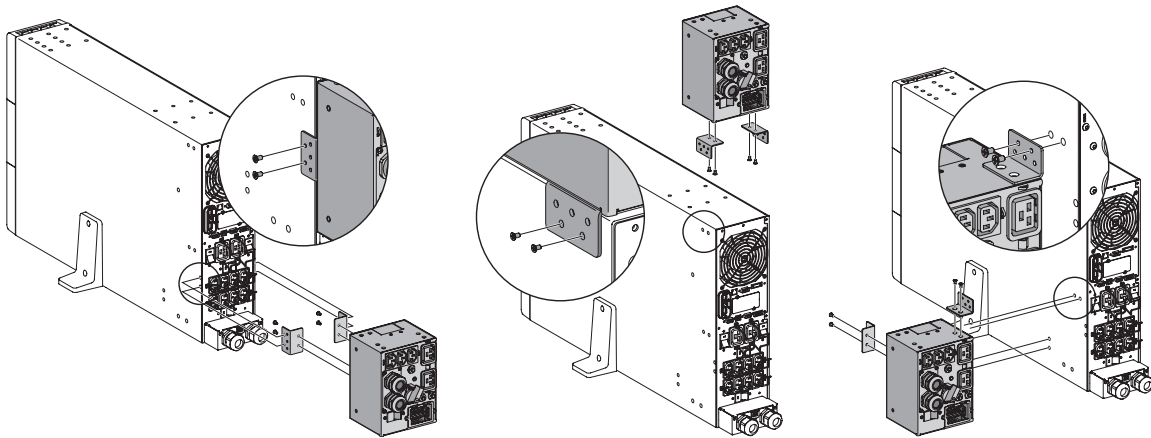

##### Rack installation

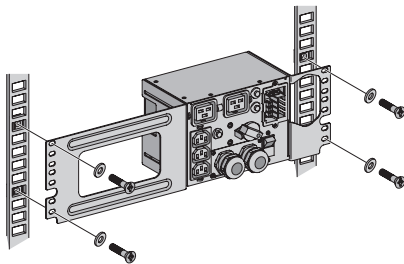

##### Wall mounting

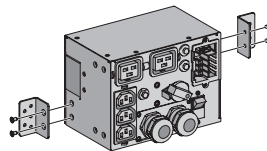

MBP11Ki / MBP11Ki31

Tower installation

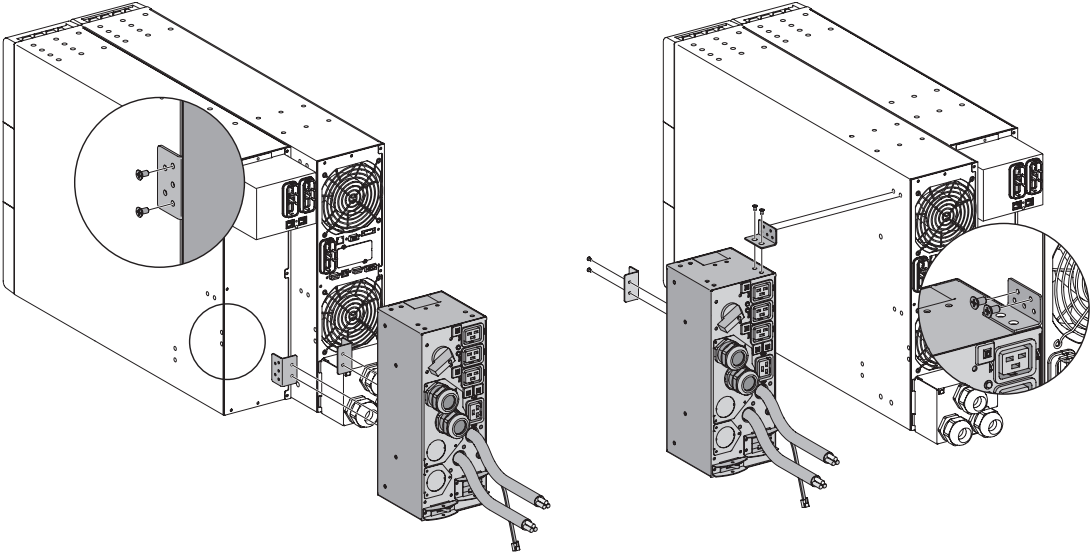

Rack installation

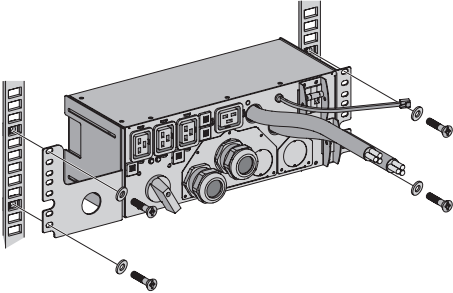

Wall mounting

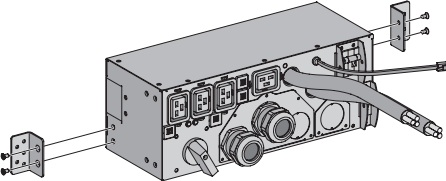

Description	Weight (lb/kg)	Dimensions (inch/mm) D x W x H
MBP6Ki	5.5 / 2.5	4.3 x 7.0 x 5.1 / 110 x 177 x 130
MBP11Ki	12.1 / 5.5	5.2 x 13.2 x 5.1 / 132 x 336 x 130
MBP11Ki31	12.1 / 5.5	5.2 x 13.2 x 5.1 / 132 x 336 x 130

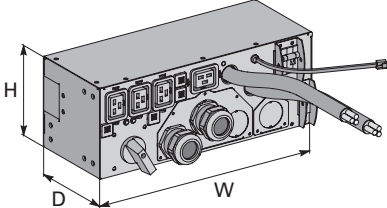
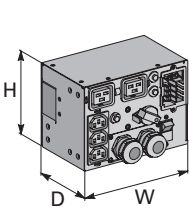

## 2. Presentation

### 2.2 Description / Panels

The HotSwap MBP has a manual Bypass rotary switch with two positions:

- **UPS** → the load is supplied by the UPS
- **Bypass** → the load is supplied directly by the AC power source



On MBP11Ki and MBP11Ki31, it is possible to Bypass the load on a separate Bypass AC source (see 4.3 for more details)

2 lights indicate the HotSwap MBP power status:

- **"UPS supply"** green light: when active, the UPS output is available, the Bypass switch can be safely turned to UPS position
- **"Bypass mode"** red light: when active, indicates that the HotSwap MBP is on "Bypass mode" (Bypass switch turned to Bypass position)

#### Normal AC source switch / Bypass AC source switch (following MBP versions):

→ Allow to safely switch off the AC source of the UPS, for UPS maintenance / replacing

#### MBP status detection:

A signal cable, with RJ11 connector to plug to the UPS, allows the communication to the UPS to manage the MBP status, and the indication on UPS display panel of both following status:

- MBP connection to UPS
- Bypass switch position

Check the UPS user manual to check the compatibility of this feature, or contact Eaton reseller for more information

#### MBP6Ki

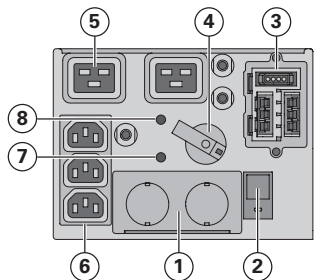

- (1) Input/Output terminal blocks
- (2) Normal AC source switch
- (3) Input/Output/MBP-Detection connector to the UPS
- (4) Manual Bypass switch
- (5) (2) 16A outlets
- (6) (3) 10A outlets
- (7) UPS supply green light
- (8) "Bypass" mode red light

#### MBP11Ki / MBP11Ki31

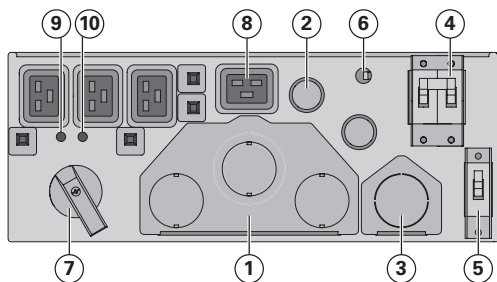

- (1) Input/Output terminal blocks
- (2) Input/Output cables for connection to the UPS
- (3) Bypass terminal blocks for connection to the UPS
- (4) Normal AC source switch
- (5) Bypass AC source switch
- (6) Signal cable for MBP detection to the UPS
- (7) Manual Bypass switch
- (8) (4) 16A outlets
- (9) UPS supply green light
- (10) "Bypass" mode red light



### 3.1 Inspecting the equipment

If any equipment has been damaged during shipment, keep the shipping cartons and packing materials for the carrier or place of purchase and file a claim for shipping damage. If you discover damage after acceptance, file a claim for concealed damage.

To file a claim for shipping damage or concealed damage:

- 1) File with the carrier within 15 days of receipt of the equipment;
- 2) Send a copy of the damage claim within 15 days to your service representative.

### 3.2 Unpacking the MBP

Unpack the equipment and remove all the packing materials and shipping carton.

Discard or recycle the packaging in a responsible manner, or store it for future use.

Place the cabinet in a protected area that has adequate airflow and is free of humidity, flammable gas, and corrosion.



Packing materials must be disposed of in compliance with all local regulations concerning waste. Recycling symbols are printed on the packing materials to facilitate sorting.

### 3.3 Checking the accessory kit

- Verify that the following additional items are included with the MBP:

#### MBP6Ki

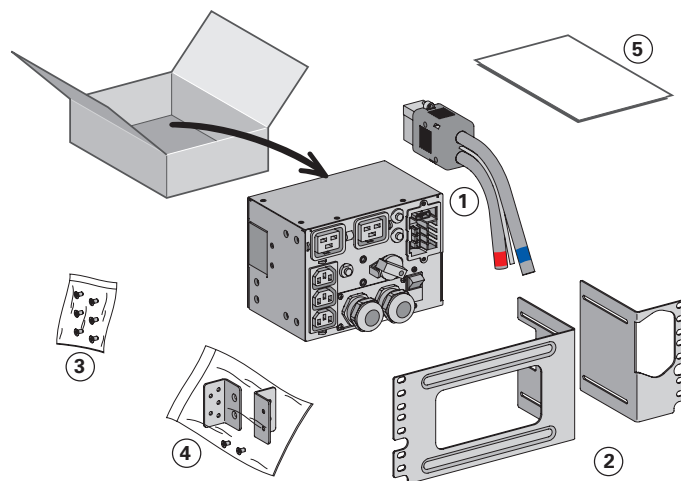

- (1) Input/Output UPS cord Set
- (2) Rack kit for 19-inch enclosures
- (3) Fixation kit for Rack mounting (including square nuts and screws)
- (4) Tower and Wall mounting kit (including 2 ears and screws)
- (5) Installation and User manual

#### MBP11Ki/ MBP11Ki31

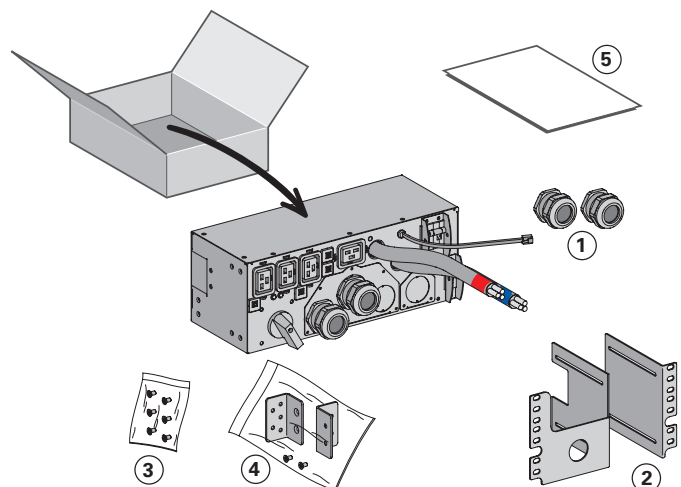

- (1) (2) cable glands for UPS Input Bypass connection (option)
- (2) Rack kit for 19-inch enclosures
- (3) Fixation kit for Rack mounting (including square nuts and screws)
- (4) Tower and Wall mounting kit (including 2 ears and screws)
- (5) Installation and User manual

## 3. Installation

### 3.4 Mechanical Mounting

- Mount the MBP (on the UPS, on the EBM, in the rack or on the wall), see 2.1.

### 3.5 Installation requirements

#### Recommended protective devices and cable cross-sections

1. Recommended upstream protection



Refer to the UPS User Manual for circuit breaker current rating.



The circuit breaker has to be installed upstream the MBP Normal AC source.

2. Recommended cable cross-sections

	Terminal position	Wire function	Terminal wire size rating	Minimum input wire size rating	Tightening torque
<b>MBP6ki</b>	L1	Phase	0.5-10 mm <sup>2</sup> (20-8 AWG)	6 mm <sup>2</sup> (10 AWG) 105°C 10 mm <sup>2</sup> (8 AWG) 75°C	1 Nm (10 lb in)
	N (L2)	Neutral (Phase)			
		Ground			
<b>MBP11ki</b>	L1	Phase	4-25 mm <sup>2</sup> (12-4 AWG)	10 mm <sup>2</sup> (8 AWG) 105°C 16 mm <sup>2</sup> (6 AWG) 90°C	2 Nm (18 lb in)
	N (L2)	Neutral (Phase)			
		Ground			
<b>MBP11ki31</b>	L1	Phase	4-25 mm <sup>2</sup> (12-4 AWG)	10 mm <sup>2</sup> (8 AWG) 105°C 16 mm <sup>2</sup> (6 AWG) 90°C	2 Nm (18 lb in)
	L2	Phase			
	L3	Phase			
	N	Neutral			
		Ground			

Copper wire, solid or stranded.

## 4. Power cables connection



This type of connection must be carried out by qualified electrical personnel. Before carrying out any connection, check that the upstream protection device (Normal AC source) is open "O" (Off).



Before proceeding to connect the HotSwap MBP to the UPS, make sure the UPS has been properly shut down (refer to the UPS user manual).

**Always connect the ground wire first.**

### 4.1 MBP6Ki



1. Connect the 2 power cables of I/O cord Set (1) to the UPS I/O terminal blocks, following color coding on the cables and the UPS I/O cover (blue for UPS Input / red for UPS Output) – refer to the UPS user manual to check the UPS terminal blocks connection.
2. Connect the MBP detection cable from the I/O cord Set (1) to the specific UPS connector (MBP detect, refer to UPS User Manual).  
→ Only with compatible EATON UPS, contact your Eaton reseller for more information.
3. Slide the MBP I/O cover (2) after removing the 4 screws, to access to MBP terminal blocks.
4. Insert the Normal AC source cable through the cable gland.
5. Connect the wires to the Normal AC source (Input) terminal blocks.
6. Insert the Output cable through the cable gland.
7. Connect the wires to the Output terminal blocks.
8. Tighten the cable glands.
9. Slide back and secure the MBP I/O cover (2) with the 4 screws.
10. Connect the I/O cord Set (1) connector to the MBP, and secure it by fixing the 2 locking screws.

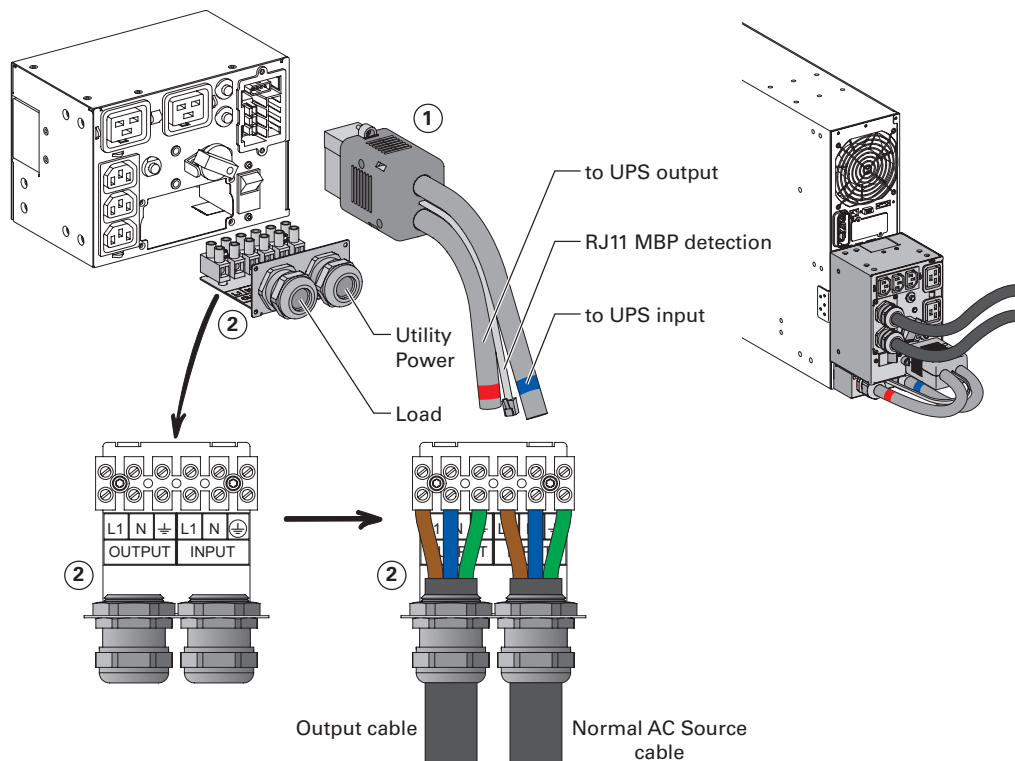

# 4. Power cables connection

## 4.2 MBP11Ki / MBP11ki31 – with common Normal and Bypass AC source



1. Connect the 2 integrated power cables (1) to the UPS I/O terminal blocks, following color coding on the cables and the UPS I/O cover (blue for UPS Input / red for UPS Output) – refer to the UPS user manual to check the UPS terminal blocks connection
2. Connect the MBP detection cable (2) to the specific UPS connector (MBP detect, refer to the UPS User Manual)  
→ Only with compatible EATON UPS, contact your Eaton reseller for more information.
3. Slide the MBP I/O cover (3) after removing the 5 screws, to access to MBP terminal blocks
4. Insert the Normal AC source cable through the cable gland
5. Connect the wires to the Normal AC source (Input) terminal blocks (do not remove the Input Bypass AC jumper (4) and the UPS Input Bypass jumper inside the UPS I/O cover (refer to the UPS User Manual)
6. Insert the Output cable through the cable gland
7. Connect the wires to the Output terminal blocks
8. Tighten the cable glands
9. Slide back and secure the MBP I/O cover (3) with the 5 screws

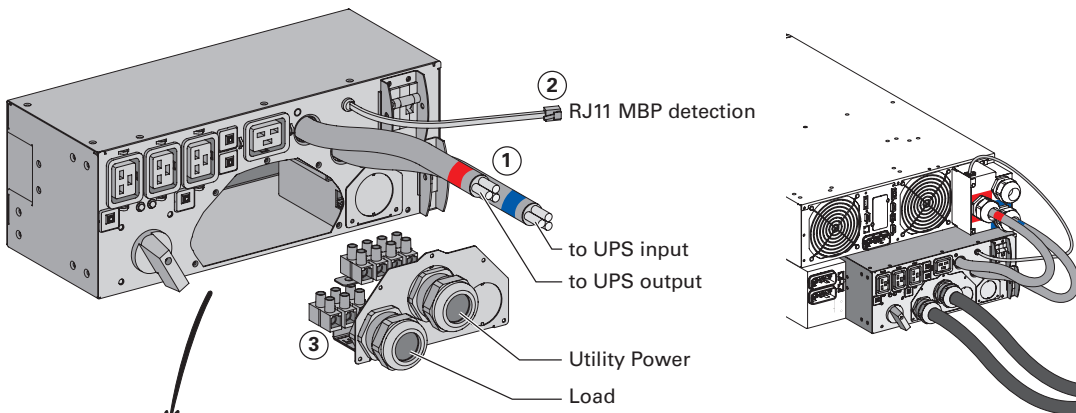

### MBP11Ki

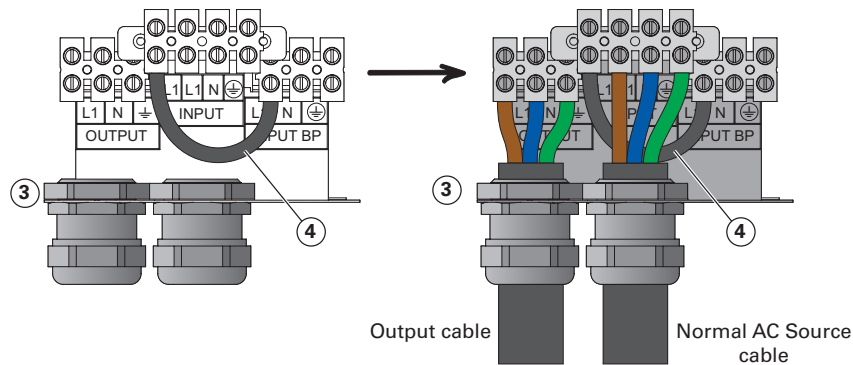

### MBP11Ki31

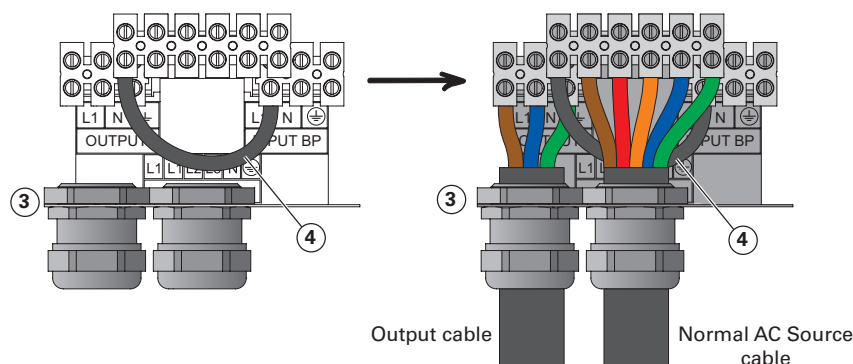

## 4. Power cables connection

### 4.3 MBP11Ki / MBP11Ki31 – with separate Normal and Bypass AC source

- Slide the MBP Bypass Input cover (5) after removing the 3 screws.
- Punch the UPS Bypass Input knockout of the MBP Bypass Input cover (5) and insert a provided cable gland inside.

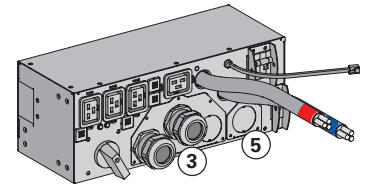
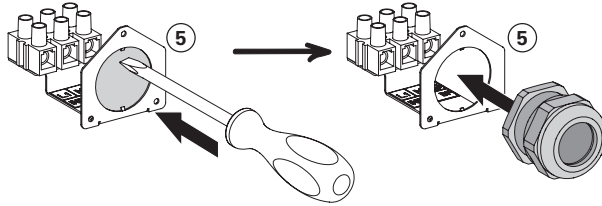

- Insert a power cable (refer to 3.5 for cable cross-section) through the cable gland of the MBP Bypass Input cover (5) (cable not provided in the packaging).

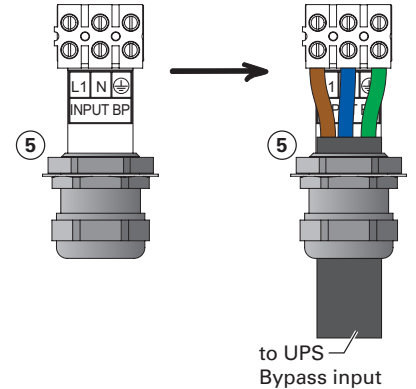

- Connect the wires to the "Input BP" terminal blocks of the MBP Bypass Input cover (5).

- Tighten the cable gland.

- Slide back and secure the MBP Bypass Input cover (5) with the 3 screws.

- Connect the 2 integrated power cables (1) and the previously installed Bypass Input power cable to the UPS I/O terminal blocks, following color coding on the cables and the UPS I/O cover (blue for UPS Input / red for UPS Output / yellow for UPS Input Bypass) – refer to the UPS user manual to check the UPS terminal blocks connection (do not forget to also remove the Input Bypass AC jumper on UPS).



- Connect the MBP detection cable (2) to the specific UPS connector (MBP detect, refer to the UPS User Manual)  
→ Only with compatible EATON UPS, contact your Eaton reseller for more information.

- Slide the MBP I/O cover (3) after removing the 5 screws, to access to MBP terminal blocks

- Remove the Input Bypass AC jumper (4)

- Punch the Bypass AC Source knockout of the MBP I/O cover (3) and insert a provided cable gland inside

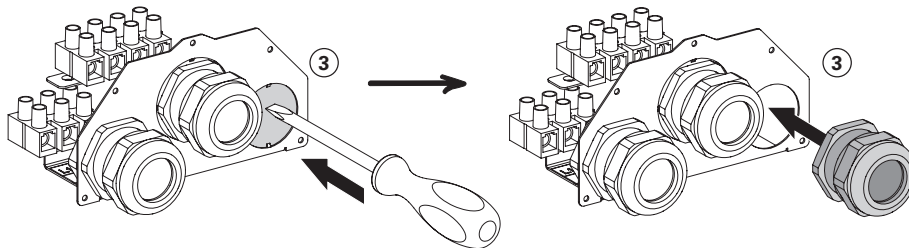
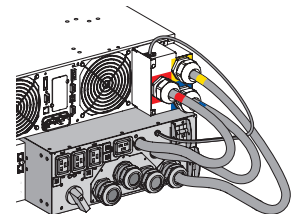

MBP11Ki

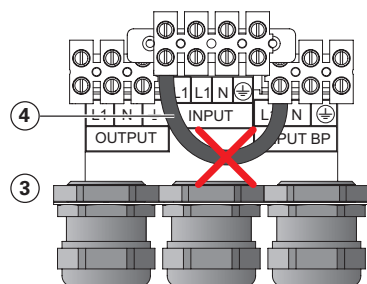

MBP11Ki31

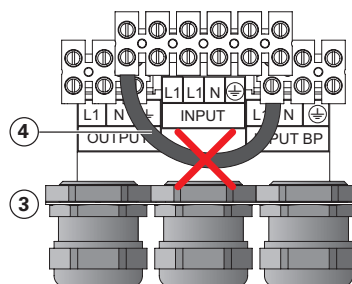

## 4. Power cables connection

12. Insert the Normal AC source cable through the cable gland
13. Connect the wires to the Normal AC source (Input) terminal blocks
14. Insert the Bypass AC source cable through the cable gland
15. Connect the wires to the Bypass AC source (Input BP) terminal blocks
16. Insert the Output cable through the cable gland
17. Connect the wires to the Output terminal blocks
18. Tighten the cable glands
19. Slide back and secure the MBP I/O cover (3) with the 5 screws

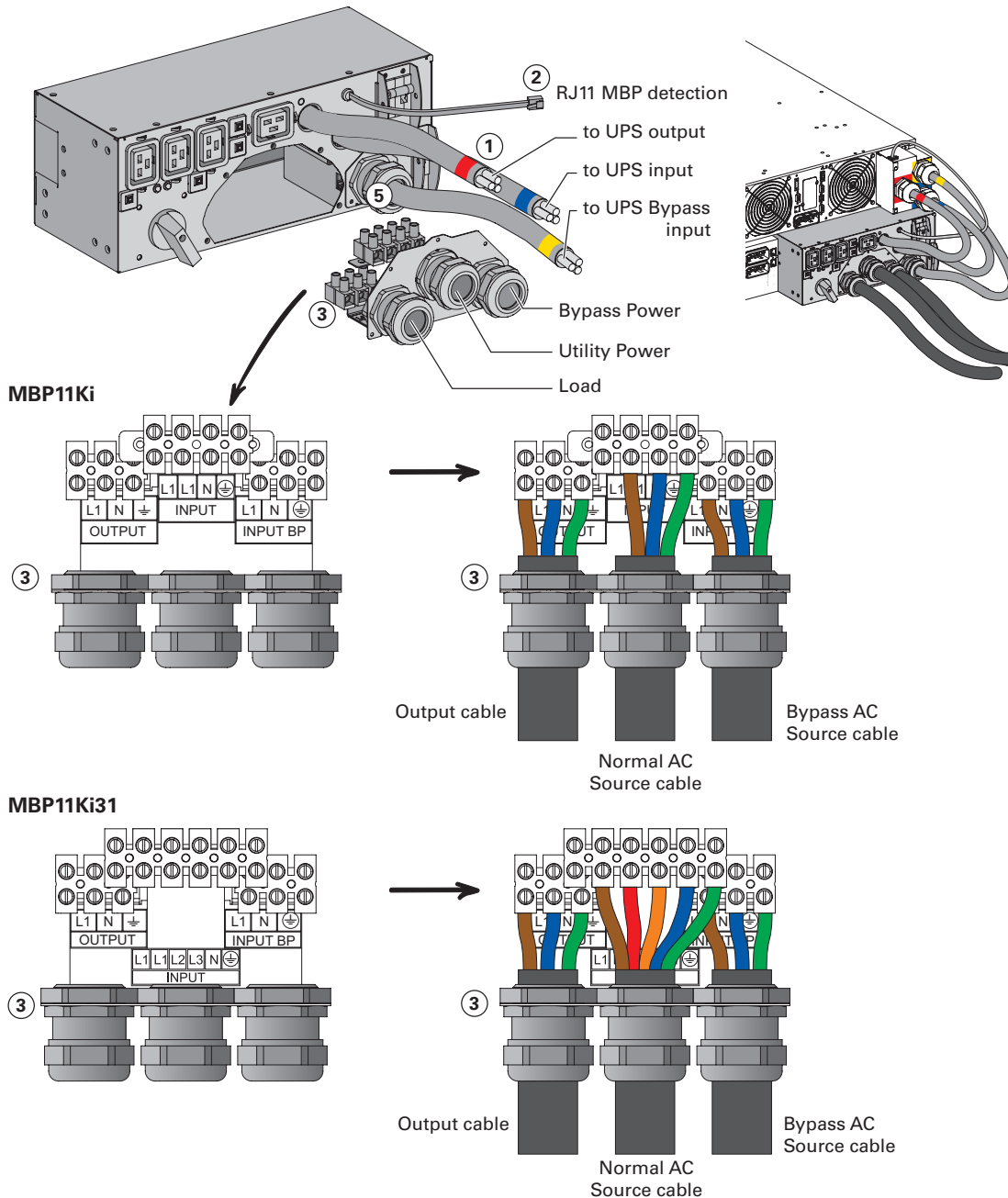

## 5.1 UPS start-up with HotSwap MBP



Verify that the total equipment ratings do not exceed the UPS capacity to prevent an overload alarm.

1. Check that the UPS is correctly connected to the HotSwap MBP (see previous chapter 4)



**If the UPS is equipped with outlets**, those outlets can no longer be used (loads can only be connected to the MBP outlets or the MBP Output terminal blocks).

2. Verify that the MBP terminal blocks are connected to the AC source, and to the Bypass AC source (\*)

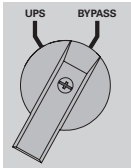

3. Check that the MBP manual Bypass switch is to the **"Bypass" position**
4. Set the upstream circuit breaker (not provided) to the "I" position (On) to switch On the utility power, and also set the Bypass source upstream circuit breaker (not provided) to the "I" position (On) to switch on the Bypass power (\*)
5. Verify that the **"Bypass mode" red light** of the MBP goes On, indicating that the load is now powered by the AC source, or Bypass AC source (\*)
6. Set the Normal AC source switch and the Bypass AC source switch (\*) of the MBP to the "I" position
7. Verify that the UPS is correctly powered (UPS display panel illuminates)
8. Press the UPS **"ON"** button to start the UPS
9. Put the UPS in **"internal Bypass mode"** (refer to the UPS User Manual)
10. Verify that the UPS is on Bypass mode by checking UPS display panel (refer to the UPS user manual)
11. Verify that the **"UPS mode" green light** of the MBP goes On, indicating that the UPS output power is available on the MBP



**Important:** do not continue to next step if the **"UPS mode" green light** of the MBP is still Off (the load will be lost)

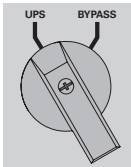

12. Set the MBP manual Bypass switch to the **"UPS" position**: the **"Bypass mode" red light** of the MBP goes Off, indicating that the load is now powered by the UPS
13. Put the UPS in **"normal mode"** (refer to the UPS User Manual)
14. Check that the UPS is in Online mode by checking UPS display panel (refer to the UPS user manual) the load is now protected by the UPS

(\*) **only in case of Bypass AC source option connected (MBP11Ki and MBP11Ki31 only).**

# 5. Operations

## 5.2 UPS replacement with HotSwap MBP

**UPS Removing (please follow the MANDATORY step below):**



**MBP6Ki:**



1. Put the UPS in "**internal Bypass mode**" (refer to the UPS user manual)
2. Verify that the UPS is on Bypass mode by checking UPS display panel (refer to the UPS user manual)
3. Set the MBP manual Bypass switch to "**Bypass**" position. The "**Bypass mode**" red light of the MBP goes On, indicating that the load is supplied directly by AC source
4. Switch the Normal AC source switch of the MBP to the "0" position and wait 30 seconds
5. UPS stops, the UPS can now be disconnected, as described below:

- First disconnect the I/O cord Set **(1)** from the MBP, after removing the 2 screws.

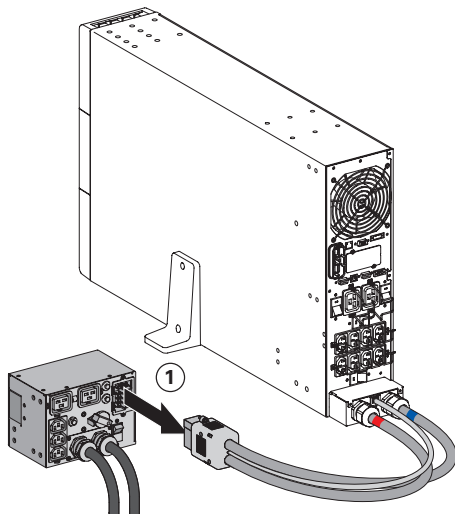

- After opening the UPS I/O terminal blocks cover, check if hazardous voltage is no longer present on UPS terminal blocks by using an electrical safety tester.

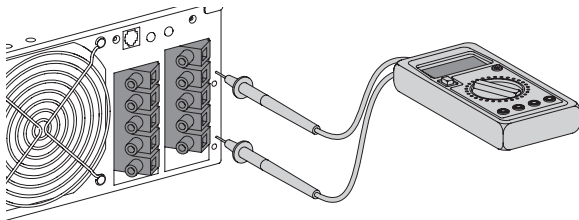

- Disconnect the 2 power cables, and the MBP detection cable (following UPS versions), of the MBP I/O cord Set **(1)**.
- Replace the UPS.



Hazardous voltage and lost load risk: do not manipulate the MBP manual Bypass switch without UPS connected via the I/O cord Set **(1)**.



## MBP11Ki / MBP11Ki31:

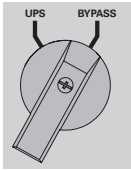

1. Put the UPS in "**internal Bypass mode**" (refer to the UPS user manual)
2. Verify that the UPS is on Bypass mode by checking UPS display panel (refer to the UPS user manual)
3. Set the MBP manual Bypass switch to "**Bypass**" position. The "**Bypass mode**" **red light** of the MBP goes On, indicating that the load is supplied directly by AC source, or Bypass AC source (\*)
4. Switch the Normal AC source switch and the Bypass AC source switch (\*) of the MBP to the "0" position and wait 30 seconds
5. UPS stops, the UPS can now be disconnected, as described below:
  - First lock the Normal AC source switch (4) and the Bypass AC source switch (5) (\*) of the MBP to the "0" position (the switch protection frames are able to fit a cable tie or a metallic locker).

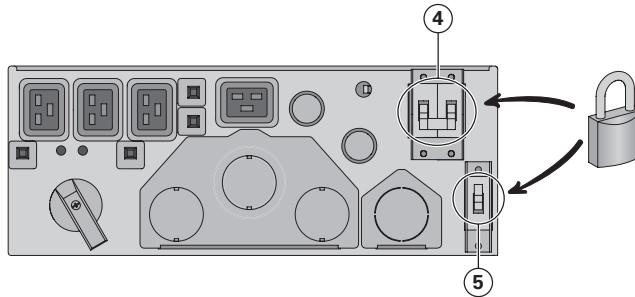

- After opening the UPS I/O terminal blocks cover, check if hazardous voltage is no longer present on UPS terminal blocks by using an electrical safety tester.

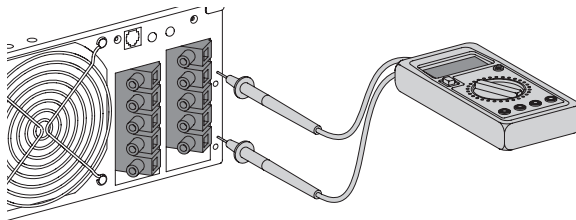

- Disconnect the MBP power power cables, and the MBP detection cable (following UPS versions).
- On each MBP power cables just disconnected from the UPS, link the wires together (line and neutral wires linked to ground wire).

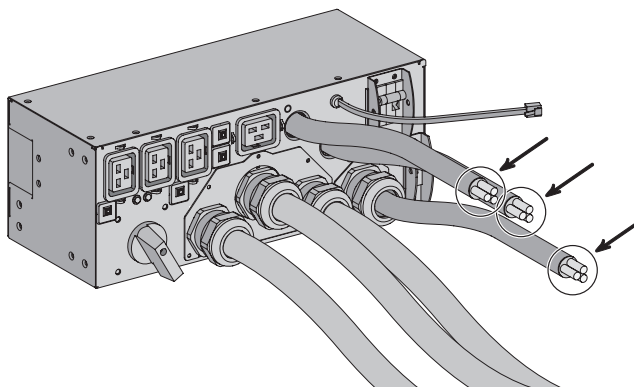

- Replace the UPS



Hazardous voltage and lost load risk: do not manipulate the MBP manual Bypass switch without UPS connected to the MBP power cables

(\*) **only in case of Bypass AC source option connected (MBP11Ki and MBP11Ki31 only).**

## 5. Operations

### Return to normal operation:

1. Check that the new UPS is correctly connected to the MBP, as described below:

#### MBP6Ki:

- After opening the UPS I/O terminal blocks cover, connect to UPS the 2 power cables, and the MBP detection cable (following UPS versions), of the MBP I/O cord Set (1)– see 4.1 for more details
- Connect the I/O cord Set (1) connector to the MBP, and secure it by fixing the 2 locking screws

#### MBP11Ki / MBP11Ki31 :

- First check that the Normal AC source switch (4) and the Bypass AC source switch (5) (\*) of the MBP are still locked to the "0" position
  - Remove the previously installed safety wires links on each MBP power cables
  - After opening the UPS I/O terminal blocks cover, connect to UPS the MBP power cables, and the MBP detection cable (following UPS versions) – see 4.2 and 4.3 for more details
  - Unlock the Normal AC source switch (4) and the Bypass AC source switch (5) (\*) of the MBP.
2. Set the Normal AC source switch and the Bypass AC source switch (\*) of the MBP to the "I" position
  3. Verify that the UPS is correctly powered (UPS display panel illuminates)
  4. Press the UPS "ON" button to start the UPS
  5. Put the UPS in "**internal Bypass mode**" (refer to the UPS User Manual)
  6. Verify that the UPS is on Bypass mode by checking UPS display panel (refer to the UPS user manual)
  7. Verify that the "**UPS mode**" **green light** of the MBP goes On, indicating that the UPS output power is available on the MBP.



**Important:** do not continue to next step if the "**UPS mode**" **green light** of the MBP is still Off (the load will be lost)

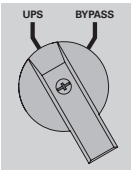

8. Set the **MBP** manual Bypass switch to the "**UPS**" position: the "**Bypass mode**" **red light** of the MBP goes Off, indicating that the load is now powered by the UPS
9. Put the UPS in "**normal mode**" (refer to the UPS User Manual)
10. Check that the UPS is in Online mode by checking UPS display panel (refer to the UPS user manual) the load is now protected by the UPS

### 5.3 UPS maintenance with HotSwap MBP

**Go to maintenance Bypass operation (please follow the MANDATORY steps below):**

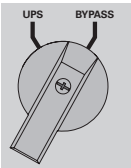

1. Put the UPS in "**internal Bypass mode**" (refer to the UPS user manual)
2. Verify that the UPS is on Bypass mode by checking UPS display panel (refer to the UPS user manual)
3. Set the MBP manual Bypass switch to "**Bypass**" position. The "**Bypass mode**" **red light** of the MBP goes On, indicating that the load is supplied directly by AC source, or Bypass AC source (\*)
4. Proceed to maintenance operations on UPS (refer to the UPS User Manual)

### Return to normal operation:

1. Verify that the UPS is on Bypass mode by checking UPS display panel (refer to the UPS user manual)
2. Verify that the "**UPS mode**" **green light** of the MBP is On, indicating that the UPS output power is available on the MBP



**Important:** do not continue to next step if the "**UPS mode**" **green light** of the MBP is Off (the load will be lost)

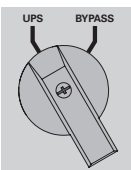

3. Set the MBP manual Bypass switch to the "**UPS**" position: the "**Bypass mode**" **red light** of the MBP goes Off, indicating that the load is now powered by the UPS
  4. Put the UPS in "**normal mode**" (refer to the UPS User Manual)
  5. Check that the UPS is in Online mode by checking UPS display panel (refer to the UPS user manual) the load is now protected by the UPS
- (\* ) **only in case of Bypass AC source option connected (MBP11Ki and MBP11Ki31 only).**

	MBP6Ki	MBP11Ki	MBP11Ki31
<b>Input</b>			
	Terminal blocks		
<b>Input Bypass</b>			
	N/A	Terminal Blocks	Terminal Blocks
<b>Output</b>			
	2 IEC 16A + 3IEC 10A + Terminal blocks	4 IEC 16A + Terminal blocks	4 IEC 16A + Terminal blocks
<b>Overall dimensions D x W x H (inch / mm)</b>			
	<b>5.6 x 7.0 x 5.1</b> / 142 x 177 x 130	<b>6.8 x 13.2 x 5.1</b> / 172 x 336 x 130	<b>7.1 x 13.2 x 5.1</b> / 181 x 336 x 130
<b>Weight (lb / kg)</b>			
	<b>5.5</b> / 2.5	<b>12.1</b> / 5.5	<b>12.1</b> / 5.5
<b>Performance</b>			
Nominal voltage	200 - 240 V ~	200 - 240 V ~	350 - 430 V ~
Frequency	50/60 Hz		
Input nominal current	30A	50A	50A
Maximal power	6000 VA	11000 VA	11000 VA
<b>Standards (HotSwap MBP used with UPS)</b>			
Safety	IEC/EN 62040-1 / Ed.1: 2008		
EMC	IEC 62040-2 / Ed.2: 2005 EN 62040-2 / Ed.2: 2006		
Performance	IEC/EN 62040-3 / Ed.2.0: 2011.		
ESD	IEC 61000-4-2 : level 3.		
Radiated field	IEC 61000-4-3 : level 3.		
EFT	IEC 61000-4-4 : level 4.		
Fast transients	IEC 61000-4-5 : level 4.		
Electromagnetic field	IEC 61000-4-6 : level 3.		
Conducted magnetic field	IEC 61000-4-8 : level 4.		
<b>Marking</b>			
	CE		
<b>Environment</b>			
Operating temperature	0 to 40°C (32 to 104°F)		
Storage temperature	-15 to 60°C (5 to 140°F)		
Transit temperature	-25 to 55°C (-13 to 130°F)		
Humidity	0 to 95% no condensing		
Operation Altitude	Up to 3,000 meters (9,843 ft) above sea level with 10% derating per 1000m		
Transit Altitude	Up to 10,000 meters (32,808 ft) above sea level		

