

CONNECTION AND FUNCTIONAL DIAGRAM

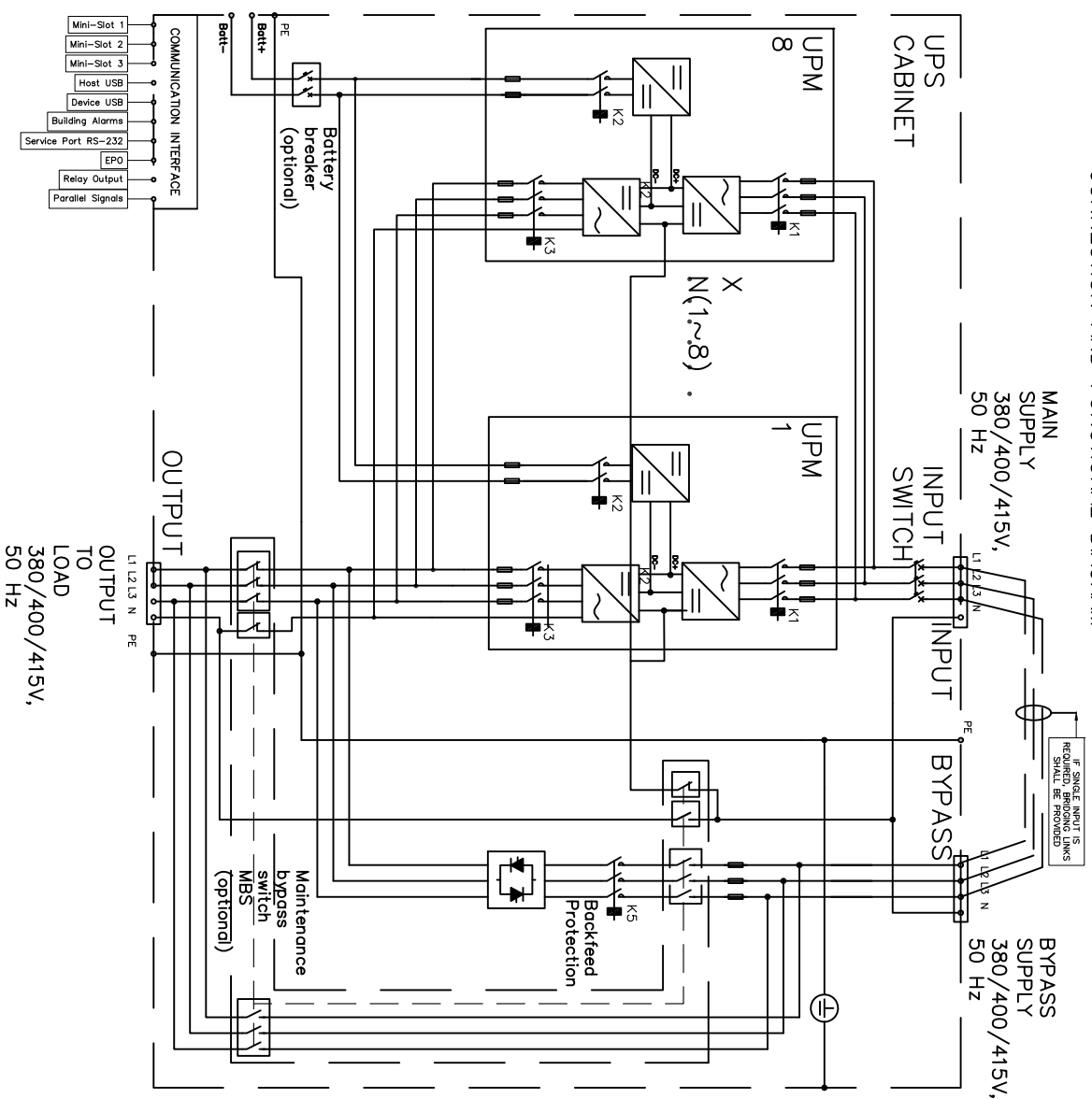

- Notes:
1. The system must be installed on a level floor and in a clean environment suitable for electronic equipment.
 2. Ambient temperature range: 0–40C without de-rating; Recommended operating range: 20–25C;
 3. Maximum relative humidity: 95% non-condensing.
 4. Minimum Clearances for ventilation & service around the UPS cabinet are:
Overhead of UPS: 800mm clearance required for ventilation
Rear of UPS: Observe minimum clearance requirements for air flow. refer to table.
Front : 1000mm clearance in front of the UPS cabinet is required for User & Service Access
Side : No clearance required
 5. Bottom & Top cable entry through removable gland plate
 6. All wiring and cabling is to be in accordance with National and Local Electrical Standards
 7. No provision for batteries within UPS cabinet
 7. Cabinet shown with bolt-down brackets fitted. These can be removed, UPS is fitted with wheels and levelling screws

UPS Installation Specifications

UPS Rating	Rated AC Input Voltage	Rated AC Output Voltage	Rectifier AC Input Current		Bypass Input current		Battery Current (40 batteries, 100% load at end of discharge)	Inverter AC Output Current Continuous	Input & Output cable max. size	Battery cable max. size	Earth cable max. size	Net Weight	Floor loading		Air-Flow Requirement
			Nominal	Maximum	Nominal	Maximum							Point Loading	Distributed Loading	
kVA	kW	VOLT	AMP	AMP	AMP	AMP	AMP	AMP	mm ²	mm ²	mm ²	kg	Points/kg	kg/m ²	m ³ /hr
50	50		76	90	72	90	125	72	240	2*240	240	424	8/35	883	5
75	75		114	135	108	135	188	108	240	2*240	240	452	8/35	942	5
100	100		151	180	144	180	250	144	240	2*240	240	480	8/35	1000	5
125	125	400/230 -15%, +20%	189	225	180	225	313	180	240	2*240	240	505	8/35	1052	5
150	150		227	270	216	270	375	217	240	2*240	240	536	8/35	1117	5
175	175		264	315	252	315	438	253	240	2*240	240	564	8/35	1175	5
200	200		302	360	288	360	500	289	240	2*240	240	592	8/39	1233	5

Minimum Clearance	
Top of Cabinet	800 mm
Front of Cabinet	1000 mm
Back of Cabinet	800 mm

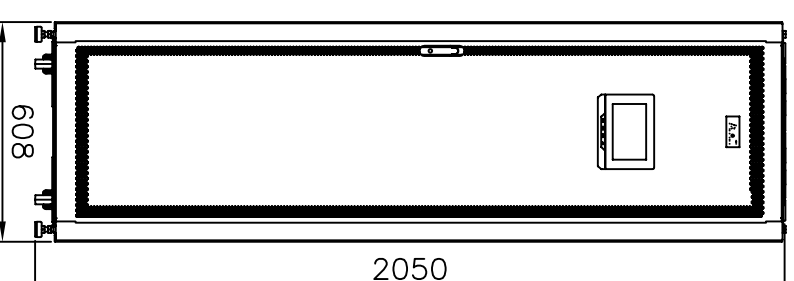
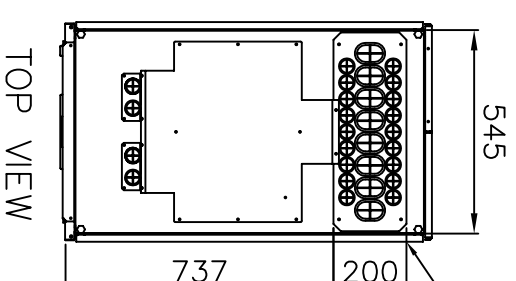

FRONT VIEW

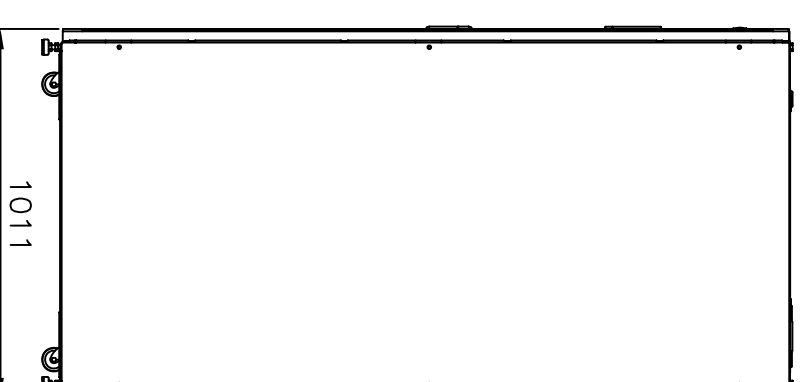

RIGHT VIEW

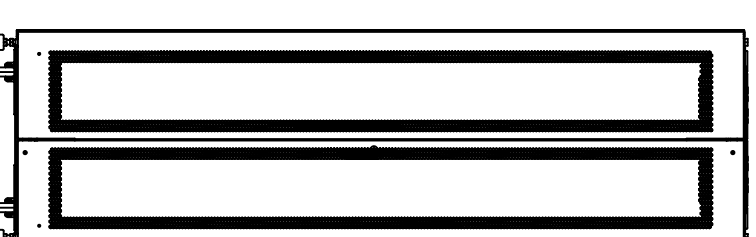

REAR VIEW

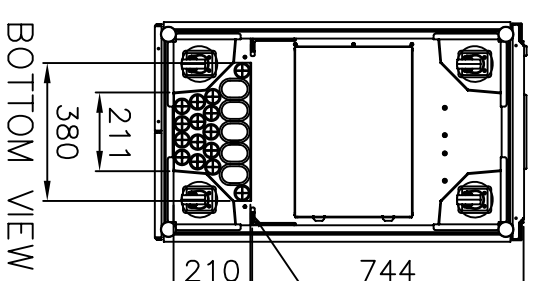

BOTTOM VIEW

Power Connection

*Drawings and UPS Specifications are subject to change.



EATON
Powering Business Worldwide

UNLESS OTHERWISE SPECIFIED ALL DIMENSIONS IN MILLIMETRES.

DRAWING NUMBER	REV
93PR 50-200kVA Standard Models	0
TITLE	
SITE PLANNING GUIDE	
93PR 50-200kVA Standard Models	
SCALE	FILENAME:
NTS	
DATE	
05.05.2016	
R.I.	
	A4