USER MANUAL

SIMPRO MULTI-TIP®





Copyright © 2022 Simpro Handling Equipment Ltd.

No part of this document may be reproduced or transmitted in any form or by any means, electronic, mechanical, photocopying, recording, or otherwise, without the written permission of Simpro Handling Equipment Ltd.

For the purposes of standards compliance and international conformity, this document uses Système International (SI) units. These may be converted to Imperial units as follows:

1 kilogram (kg) = 2.2 pounds (lb)

1 metre (m) = 1000 millimetres (mm) = 39.37 inches (in) = 3.28 feet (ft) = 1.09 yards (yd)

The following stylistic conventions are used throughout this document:

 Point of interest

 Safety hazard

§ Section reference (hyperlink in PDF edition)

 Simpro partcode (hyperlink in PDF edition)

Errors in this document should be reported by email to info@simpro.world

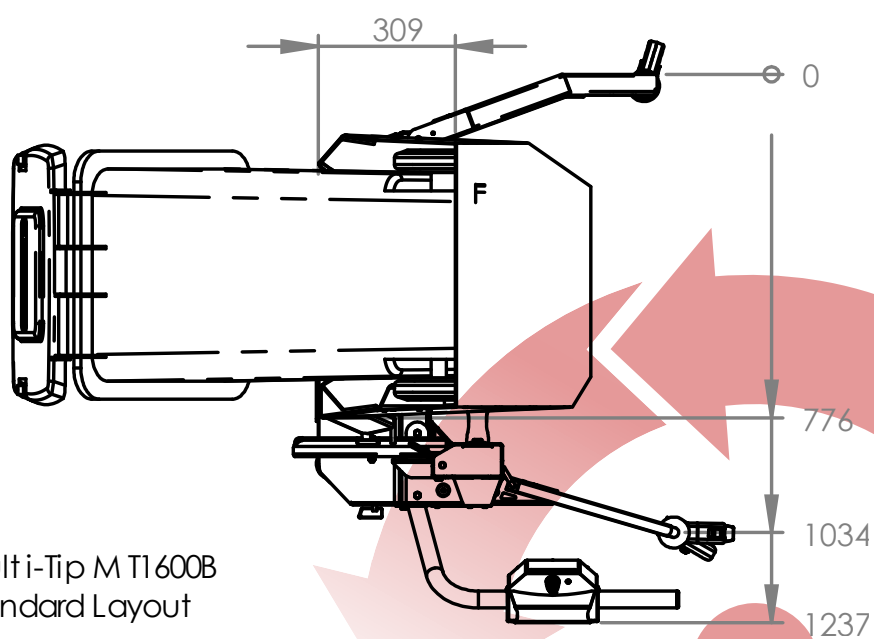
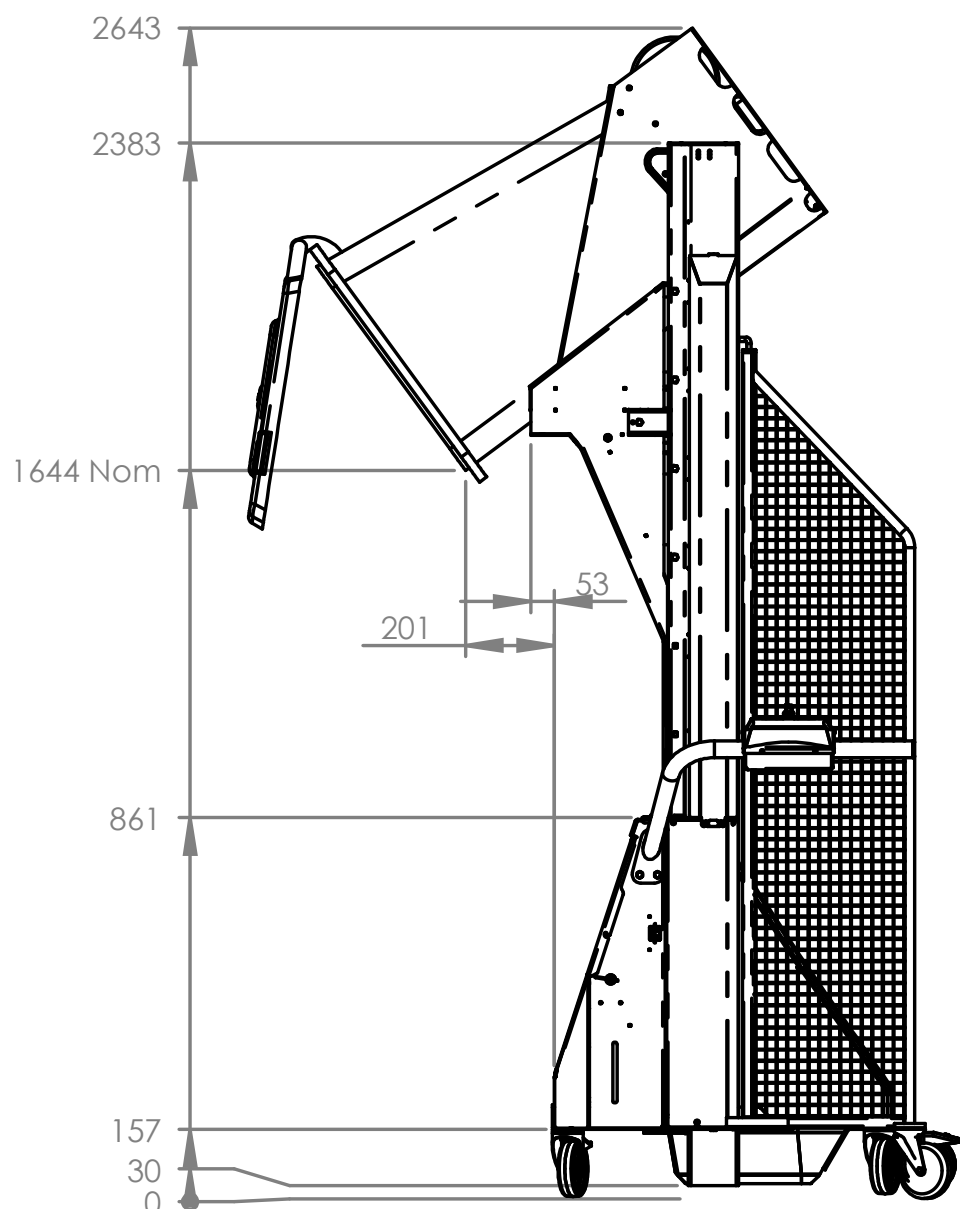

Multi-Tip M TI 600B
Standard Layout

Contents

1. Product Overview	5
1.1 Key Features	6
1.2 Construction	6
1.3 Mechanism	6
1.4 Safe Working Load	6
1.5 Duty cycle	7
1.6 Service life	7
1.7 Noise emissions	7
1.8 Environmental restrictions	8
1.9 Ingress protection	8
1.10 Notes	8
2. Operating Instructions	9
2.1 Before operation	9
2.2 Emplacing and removing bins	9
2.2.1 Cradle identification	9
2.2.2 Type-E Cradle (standard)	11
2.2.3 Type-C Cradle	11
2.2.4 Type-A Cradle	11
2.2.5 Type-A Cradle with base	12
2.2.6 Type-D Cradle	12
2.2.7 Type-X Cradle (custom)	12
2.3 Operation of controls	13
2.4 Battery charging	14
2.5 Safety Norms	15
3. Care and Maintenance	17
3.1 Quick Troubleshooting Guide	17
3.2 Cleaning	18
3.3 Cradle jams	18
3.3.1 Cradle jams while raising	18
3.3.2 Cradle jams while lowering	18
3.4 Electrical System (battery)	20
3.4.1 International conformance	20
3.4.2 Voltmeter	20
3.4.3 Batteries	20
3.4.4 Battery charger	21
3.4.5 Charging lead	21
3.4.6 Emergency stop	21
3.4.7 Circuit breaker	21
3.4.8 Solar panel	21
3.5 Electrical System (3-phase mains)	22
3.5.1 International conformance	22
3.5.2 Transformer	23

3.6	Electrical System (1-phase mains)	24
3.6.1	International conformance	24
3.6.2	Transformer	24
3.6.3	Variable Speed Drive	24
3.7	Hydraulic System	25
3.7.1	Powerpack	25
3.7.2	Control valves	25
3.7.3	Lift ram	25
3.7.4	Hydraulic fluid	25
3.7.5	Maintenance	25
3.7.6	Hydraulic system schematic	26
3.8	Preventative Maintenance Inspections	27
3.8.1	Pre-inspection checklist	27
3.8.2	Monthly inspection	27
3.8.3	Annual inspection	29
4.	Assembly, Handling and Storage	31
4.1	Assembly	31
4.2	Moving	31
4.3	Lifting	31
4.4	Transport	31
4.4.1	Horizontal transport	32
4.5	Storage	32
5.	Safety Assessment	33
5.1	Safety features	33
5.2	Reasonably foreseeable misuse	33
5.3	Hazard and Risk Assessment Guide	33
5.4	OSH Compliance Specification Guide	38
6.	Spare Parts	41
7.	Warranty	43
8.	EC Declaration of Conformity	45
9.	Notes	46

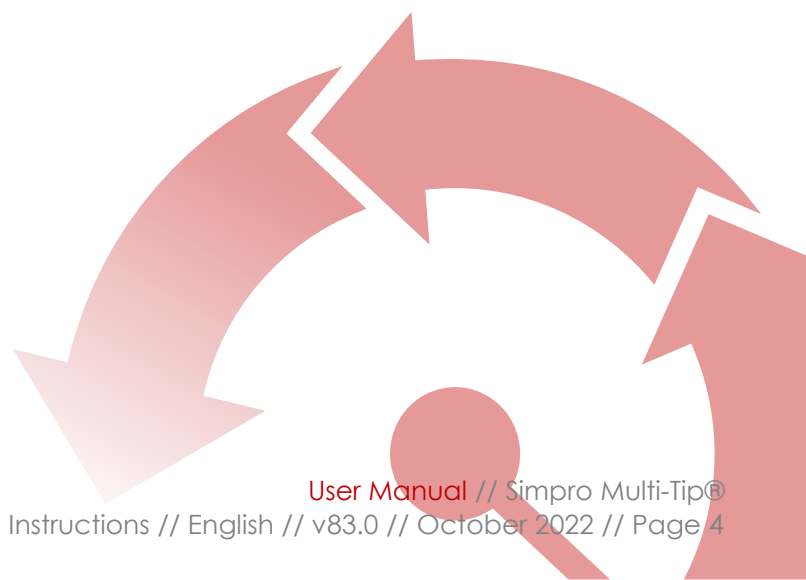

I. Product Overview

Congratulations on your purchase of a **Simpro Multi-Tip**. The Multi-Tip is everything a bin lifter should be; safe, cost-effective, and easy to use. With a 150kg lifting capacity and 15-second tipping cycle, it is an ideal solution for schools, recycling centres and small businesses.

Featuring an innovative monomast design, the Multi-Tip affords operators a clear view of operations to ensure safety. No cage-guard is required, because the two-hand control system prevents operators from accessing moving parts while using the machine. The open design is also simple to clean and maintain.

The standard Multi-Tip dumps bins at 1600mm, and is available with cradles to suit almost all common waste bins and carts. However, the modular architecture makes it simple to customise the machine for non-standard applications – such as emptying BRUTE® bins, 205-litre drums, or fish bins – at heights of 1200mm, 1600mm or 1800mm.

Like all Simpro products, the Multi-Tip is safe, durable, and requires little maintenance.



As far as compliance and relieving me of hard work, this is the best -
absolutely the best!

Graham Hawkes – Caretaker – One Tree Hill College

1.1 Key Features

Key features of the Multi-Tip include:

1. A unique tipping action whereby bins are lifted straight up, and then gently rolled forward around the lip of the container being emptied into. Benefits of this design include a small 'footprint' and high stability in use.
2. A large lifting capacity of 150kg.
3. A reliable, maintenance-free design.
4. Castor wheels and grab-handles for ease of movement.
5. A powder-coated frame and zinc-plated cradle for corrosion protection.
6. A modular cradle architecture which can be easily adapted to suit different bins, and does not require clamping or fastening – simply place the bin into the cradle and press the 'Raise' button.

1.2 Construction



The Multi-Tip consists of a steel frame with one vertical mast, a bin cradle, one hydraulic ram, guarding, castor wheels, powerpack cover, grab handle with control buttons, power lead or battery, hydraulic powerpack and control systems.

1.3 Mechanism

When operated, the bin cradle moves vertically in the masts, and is inverted at the appropriate height by a 'follower roller' running in a 'guide track'. A hydraulic ram provides the force to lift the bin. The ram is operated by a hydraulic powerpack, which is normally powered by a battery. Electronic control systems allow the operator to raise or lower the bin in a controlled manner.

1.4 Safe Working Load

The Safe Working Load of the standard Multi-Tip is **150kg (330lb)**.

-  Safe Working Load (SWL) is a gross figure, referring to the weight of the bin, its contents, and any other objects placed on the cradle.
-  Custom machines may be specified with different Safe Working Loads. The rating plate should be the first point of reference when determining SWL on any given machine.

 **Never attempt to lift bins that are heavier than the factory-specified Safe Working Load.**

1.5 Duty cycle

The duty cycle of the Multi-Tip depends on the installed powerpack, available power supply, environmental factors, and the manner in which the machine is being used. The figures given below are indicative only.

Duty Cycle (tipping ~100kg bins at 1600mm)			
Power supply	Net throughput	Number of bins	Units
24V/20Ah GEL Battery*	5,000kg	50 bins	Per charge
24V/20Ah GEL Battery on continuous charge	2000kg	20 bins	Per hour
24V/40Ah GEL Battery with Solar Panel Kit**	2,000kg	20 bins	Per day
Mains, 3-Phase ~415VAC	12,000kg	120 bins	Per hour
Mains, 1-Phase ~230VAC	6,000kg	60 bins	Per hour
12V/20Ah GEL Battery***	2,500kg	25 bins	Per charge
12V/55Ah GEL Battery***	6,000kg	60 bins	Per charge

*Two 12V/20Ah batteries in series (standard from 2022)

**Subject to weather, latitude, and panel orientation (see §3.4.8)

***Discontinued 2022

 Power supply specifications can be found on the machine's rating plate.

1.6 Service life

The nominal service life of the Multi-Tip is as follows.

Average Gross Bin Weight	Nominal service life
< 50kg	100,000 cycles
50kg – 100kg	75,000 cycles
100kg – 150kg	50,000 cycles
> 150kg	10,000 cycles

1.7 Noise emissions

The noise emissions of the Multi-Tip do not typically exceed ~60 dB(A) at the operator's ear. Hearing protection is recommended if operating the machine for extended periods.

 ISO standards for machinery safety specify that noise emissions are to be measured in A-weighted decibels (dB(A)), a unit of volume which is adjusted to reflect the sensitivity of human hearing. The measurements are taken at a point 1.6 metres above the ground at the operator's working position.

1.8 Environmental restrictions

The Multi-Tip may be used indoors or outdoors. However, the following restrictions apply:

1. A minimum floor area of two square metres, with a clear passage to exits;
2. Height above sea level not more than 1000m;
3. Ambient temperature not higher than +40°C and not lower than -10°C;
4. At ambient temperatures above 35°C, the relative humidity should not exceed 50%; at lower temperatures, higher relative humidity is permitted;

 **Never operate the machine in explosive, corrosive, acidic or alkaline environments.**

1.9 Ingress protection

Item	IP Rating
Push buttons, switches, and lamps	IP66
Door interlock	IP66
Coded magnetic switch	IP66
Motor	IP54 (note additional protection provided by covers)
Overall	IP54 (optional upgrade to IP66 or IP69K)

1.10 Notes

1. This User Manual describes approved procedures for the operation, maintenance, and routine inspection of the Simpro Multi-Tip hydraulic bin-tipping machine.
2. This manual is written in English, and is to be considered the 'Original Instructions' for the purposes of EU Machinery Directive 2006/42/EC.
3. Operator(s) must read and understand this manual before using the machine.
4. If the machine is to be leased, sold, or otherwise transferred, then this manual shall accompany the machine.
5. This is a generic manual. Simpro reserves the right to change the design of our products at any time. In cases where a discrepancy exists between the manual and the actual product, the manual is to be used as a reference only.
6. Contact your authorized Simpro agent if any problems or faults are encountered with the machine.
7. Errors in this manual should be reported by email to info@simpro.world.

2. Operating Instructions

⚠ Before the machine is used for the first time, a site-specific Hazard and Risk Assessment should be completed as per §5.3.

2.1 Before operation

Before operating a Multi-Tip, check that the machine is stable and safe to use as follows:

1. The machine is on firm ground with a slope ratio of less than 1:12.
2. All covers and safety guards are in place.
3. The wheel brakes are applied.
4. All personnel other than the operator are well clear of the machine.
5. The cradle is fully lowered.
6. The key is inserted and turned to the ON position.
7. The battery indicator (if fitted) shows an acceptable level of charge.

2.2 Emplacing and removing bins

The Multi-Tip cradle is designed to allow bins to be emplaced and removed easily, while also holding them securely throughout the tipping cycle.

⚠ It is important to understand how to correctly place bins onto the cradle, as improper placement may result in bins falling out of the machine when inverted.

2.2.1 Cradle identification

A range of different cradles may be fitted to the Multi-Tip, depending on the bins it will be emptying. Use the following table to identify the correct instructions for your machine.

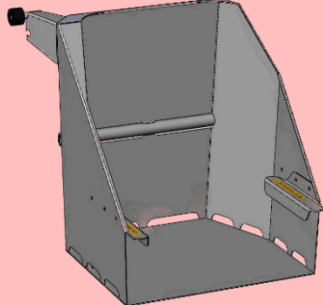
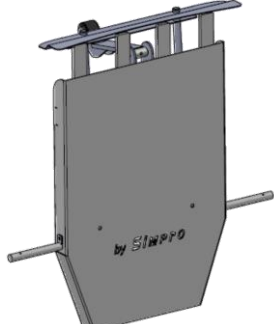
Cradle	Usage	Bin Compatibility	Cradle Image	See
Type-E (EN840 base-lift cradle)	Standard waste and recycling applications in EU, UK, AU, NZ, Asia, Africa, and parts of South America	EN840 mobile garbage bins (wheelie bins)		§2.2.2
Type-C (EN840 comb-lift cradle)	Specialised waste and recycling applications (primarily with 360-litre bins) in EU, UK, AU, NZ, Asia, Africa, and parts of South America			§2.2.3

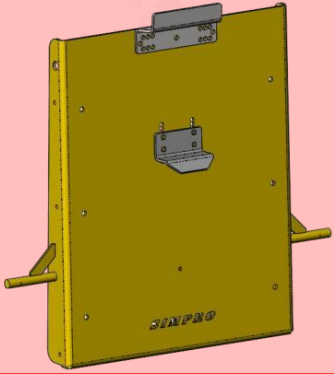
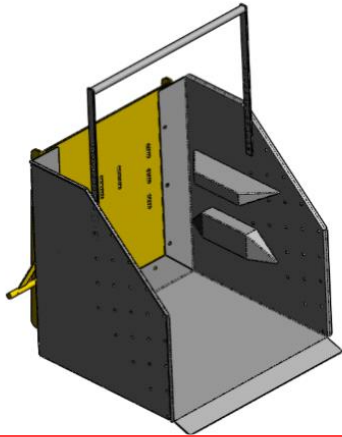
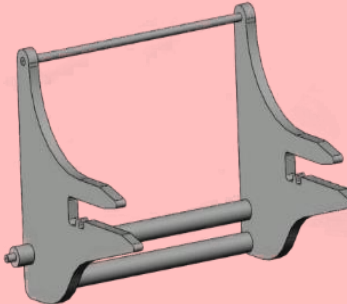
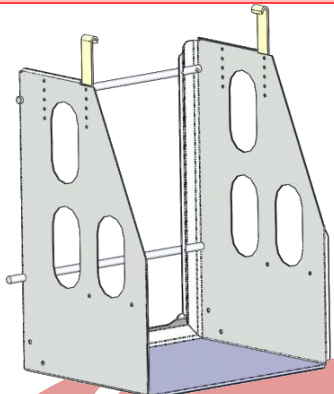
Cradle	Usage	Bin Compatibility	Cradle Image	See
Type-A (ANSI bar-lift cradle)	Standard waste and recycling applications in USA, Canada, and parts of South America	ANSI Z245.60 (Type-B) Trash Carts	<ul style="list-style-type: none"> - 32 gal - 48 gal - 64 gal - 96 gal 	§2.2.4
Type-A with base (ANSI bar-lift cradle with base)	Specialised waste and recycling applications in USA, Canada, and parts of South America	BRUTE® Bins 205L Drums Plastic Tubs Customs Bins	<ul style="list-style-type: none"> - 10 gal - 20 gal - 28 gal - 32 gal - 40 gal - 44 gal - 55 gal 	§2.2.5
Type-D (DIN9797)	Food processing applications	DIN9797 Eurobins	<ul style="list-style-type: none"> - 120L - 200L - 300L 	§2.2.6
Type-X	Custom applications	BRUTE® Bins 205L Drums Plastic Tubs Customs Bins		§2.2.7

2.2.2 Type-E Cradle (standard)

2.2.2.1 Emplacing bins

Place the wheelie bin onto the cradle. For full-size 240L bins, both wheels should be positioned into a catch (on either side of the cradle). For smaller bins such as 60L, 80L, 120L and 140L, only the left-hand wheel needs be positioned into a catch. Once the bin is correctly emplaced, walk to the control panel.

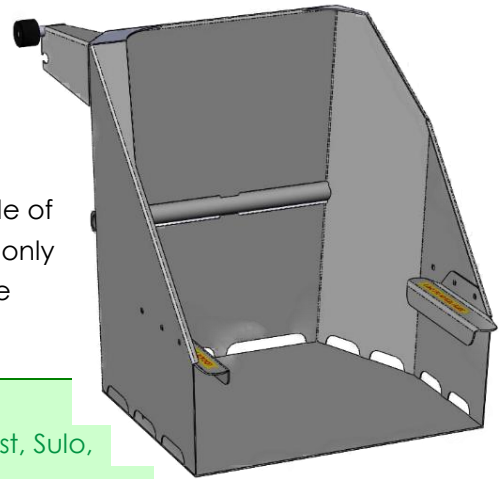

- ⚠ The wheel catches are designed to work with standard EN840 wheelie bins from leading brands such as Europlast, Sulo, ESE, Weber, Craemer, OnePlastics and Trident.
- ⚠ Some smaller bin manufacturers use axles of different lengths. If the distance between the wheels is slightly too large or small, the wheels may jam against the catches, preventing a secure emplacement. Should this occur, simply unbolt and remove the right-hand wheel catch. All bins can be securely retained using the left-hand catch only.
- ⚠ Some smaller bin manufacturers use tyres which are too wide to fit inside the wheel catches. Should this issue occur, simply insert additional packers (flat washers) onto the wheel catch mounting bolts, to increase the spacing as needed.

2.2.2.2 Removing bins

Using the grab-handle provided, gently remove the wheelie bin from the cradle.

2.2.3 Type-C Cradle

2.2.3.1 Emplacing bins

Place the wheelie bin into the machine, positioned centrally against the cradle backplate. Take care that the lifting teeth are properly hooked into the bin combing; smaller bins such as 60L and 80L may need to be tilted or lifted slightly to ensure a proper 'catch'. Once the bin is correctly emplaced, walk to the control panel.

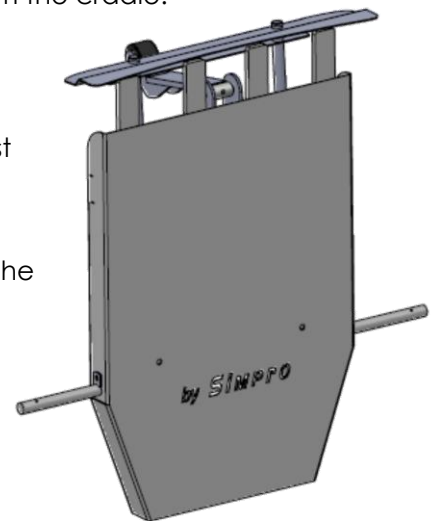

2.2.3.2 Removing bins

Using the grab-handle provided, gently remove the wheelie bin from the cradle. Some bins may need to be tilted or lifted slightly to detach them from the cradle teeth.

2.2.4 Type-A Cradle

2.2.4.1 Emplacing bins

Place the trash cart into the machine, positioned centrally against the cradle backplate. Take care that the lifting hooks are properly engaged with the front of the cart; some carts may need to be tilted or lifted slightly to ensure a proper 'catch'. Once the cart is correctly emplaced, walk to the control panel.

2.2.4.2 Removing bins

Using the grab-handle provided, gently remove the trash cart from the cradle. Some carts may need to be tilted or lifted slightly to detach them from the lifting hook.

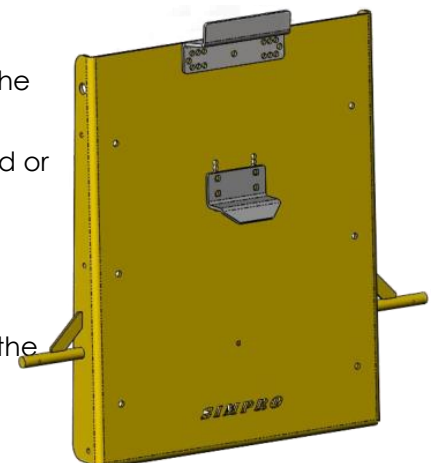

2.2.5 Type-A Cradle with base

2.2.5.1 Emplacing bins

Place the bin, drum, or container onto the cradle, positioned centrally against the backplate. Once the bin is correctly emplaced, walk to the control panel.

- ⚠ When moving heavy non-wheeled containers, it is recommended to use a dolly, hand truck or forklift attachment.
- ⚠ The catch arm(s) should be positioned to hold the top edges of the bin, with a maximum free travel of 25mm (1 inch). The arm(s) can be unbolted and repositioned to allow emptying bins of many different sizes.

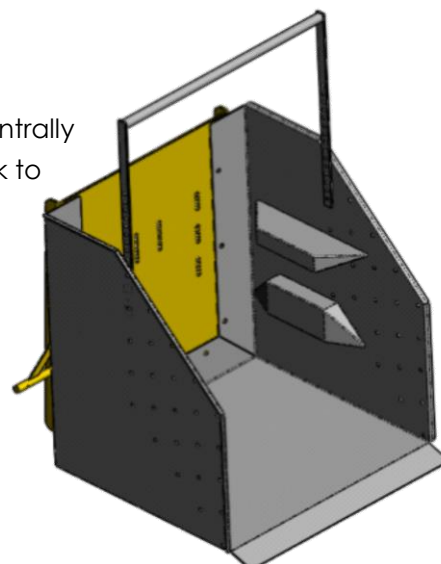

2.2.5.2 Removing bins

Holding the upper lip of the bin, drum, or container, gently remove it from the cradle.

2.2.6 Type-D Cradle

2.2.6.1 Emplacing bins

Wheel the Eurobin into the cradle, positioned centrally, until it is firmly against the buffers. Take care that both trunnions are properly seated into the lifting arms; some Eurobins may need to be tilted or lifted slightly to ensure a proper 'catch'. Once the Eurobin is correctly emplaced, walk to the control panel.

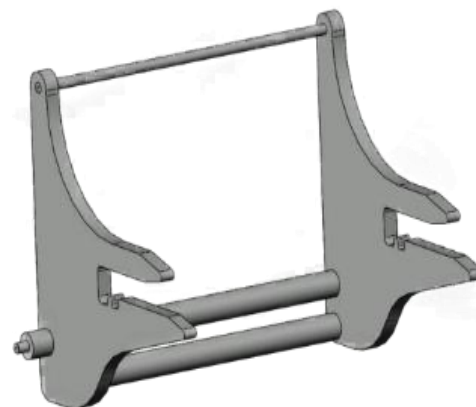

2.2.6.2 Removing bins

Using the grab-handle provided, gently remove the Eurobin from the cradle

2.2.7 Type-X Cradle (custom)

2.2.7.1 Emplacing bins

Place the bin, drum, or container onto the cradle, positioned centrally against the backplate. Once the bin is correctly emplaced, walk to the control panel.

- ⚠ When moving heavy non-wheeled containers, it is recommended to use a dolly, hand truck or forklift attachment.
- ⚠ The catch arm(s) should be positioned to hold the top edges of the bin, with a maximum free travel of 25mm (1 inch). The arm(s) can be unbolted and repositioned to allow emptying bins of many different sizes.

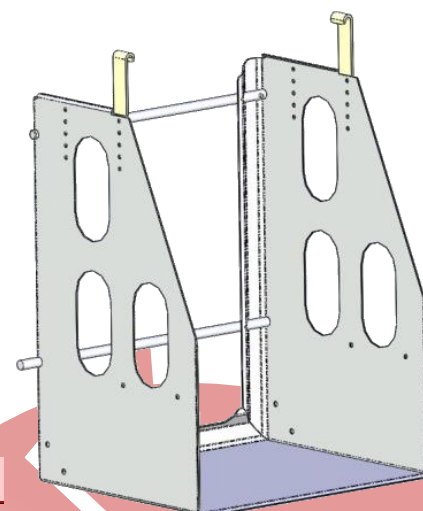

2.2.7.2 Removing bins

Holding the upper lip of the bin, drum, or container, gently remove it from the cradle.

2.3 Operation of controls

The Multi-Tip controls are designed to allow safe, intuitive operation of the machine.

⚠ It is important to understand how to use the controls correctly. Improper operation may result in a safety hazard, or damage to the machine.

1. Before operation, check that the machine is stable and safe to use as per §2.1.
2. Place the full bin on the cradle, taking care that it is correctly positioned as per §2.2.
3. Standing at the operator controls, visually confirm that no other person is within two metres of the machine.
4. Simultaneously press and hold the SAFETY button under the left side of the shroud, and the RAISE button under the right side. The cradle will start to lift.
5. When the cradle reaches the fully-raised position, the sound will change. Immediately release the SAFETY and RAISE buttons, and wait for the bin to empty.
6. When emptying is complete, simultaneously press the SAFETY and LOWER buttons, holding both down until the cradle rests back on the ground.
7. Remove the empty bin as per §2.2.
8. Repeat from step 2. as required.

⚠ Release the SAFETY button to stop the cradle at any time.

⚠ Do not continue pressing the RAISE and SAFETY buttons after the cradle has reached the fully-raised position. This will drain the battery, and can overheat the hydraulic fluid.





2.4 Battery charging

The Multi-Tip batteries should be recharged whenever the voltmeter reads less than 24.0V.

To recharge the batteries, simply plug one end of an IEC C13 power lead ("computer cord") into the C14 socket on the machine, and the other end into a 1-phase mains power outlet.

A full charge usually takes around 5 hours. The machine can be used while charging.

The onboard charger automatically adapts to different inputs (85-264VAC 50/60Hz 1-ph), manages the charging cycle to maximise battery life, and prevents overcharging.

-  The charger delivers enough power to empty a 100kg bin in about 3 minutes, which means that a battery-powered Multi-Tip can be left plugged in and used as a mains-powered machine (see §1.5).
-  For optimum battery life, the Multi-Tip should be placed on charge overnight and on weekends, even if the batteries are already fully charged.
-  The charger is in an enclosed plastic case, and is protected against short-circuit, current overload, over-voltage, and over-temperature.

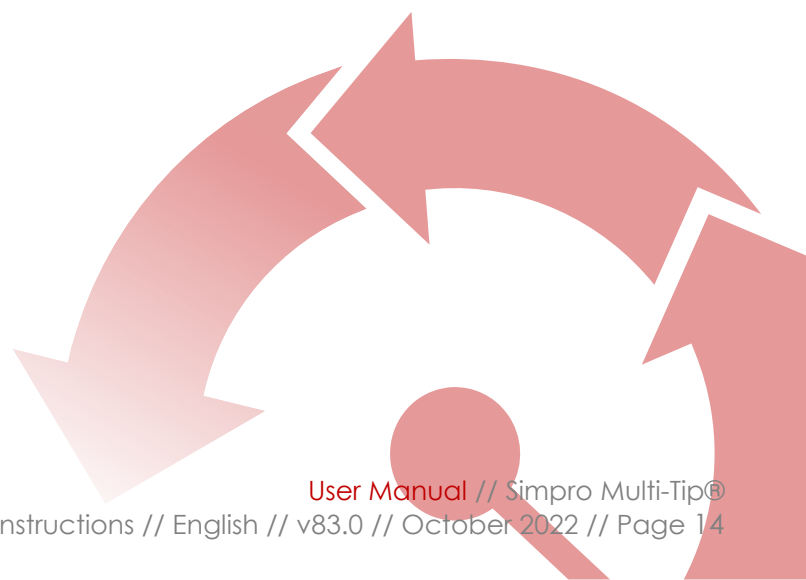

2.5 Safety Norms

The following safety norms must be observed for the safe use of a Multi-Tip bin lifter.

Only trained and authorised personnel may use the machine.

Operators must read and obey all instructions displayed on the machine.

Never operate the machine on soft ground, or ground with a slope ratio greater than 1:12.

Never operate the machine on the edge of a raised loading dock or platform.

Never operate machine with any covers or guards removed.

Never attempt to empty the contents of closed-top drums, unless the machine is securely bolted down.

All persons other than the operator must keep at least 2 metres clear while the machine is in use.

Always keep hands and feet well clear of the bin and cradle when operating.

Never place limbs, feet or foreign objects under or through the guarding panels.

Never attempt to empty over-filled bins, or bins weighing more than 150kg.

Before connecting machine to mains supply, ensure voltage and frequency correspond with that listed on the rating plate.

Do not use an extension lead longer than 15 metres to connect the machine to mains power.

Do not operate if power lead, insulation or power plugs are damaged.

Do not connect a damp power plug or socket.

Ensure the power supply socket is fitted with a residual current device.

Ensure there is complete continuity between the machine and an effective earthing system which complies with local and national regulations. The manufacturer cannot be held liable for the consequences of an inadequate earthing system.

3. Care and Maintenance

The Multi-Tip is designed to give many years of service with minimal maintenance. In the event a fault or malfunction does occur, refer to the Quick Troubleshooting Guide in §3.1 before contacting your Simpro agent for support.

- ⚠ Contact your Simpro agent if repair or service work is required.
- ⚠ All repair and service work must be carried out by qualified personnel.
- ⚠ Replacement parts must be supplied by Simpro or an authorized Simpro agent, and must be of the same design and specification as the original parts.
- ⚠ A detailed Service Manual giving specific testing and repair instructions is available on request from Simpro.

3.1 Quick Troubleshooting Guide

Please refer to the Quick Trouble Shooting Guide below before requesting technical support.

Problem	Possible Causes	Remedy	See also
The machine will not lift bins, and the motor does not run	Flat battery	The battery needs to be charged if voltmeter reads less than 24.0V.	§2.4 🔧 Battery 0250050004
	Tripped circuit breaker or fuse	Wait 1-2 minutes for circuit breaker to reset (or replace blown fuse). Avoid operating machine with flat battery.	§3.4.7 🔧 Breaker 0790050374 🔧 Fuse 0790050107
	Faulty up/down switch or wiring	Check and rectify – replace if necessary.	🔧 Up/Down switch 0790050454
	Faulty motor solenoid (battery models only)	The motor solenoid should click when the UP and SAFETY buttons are pressed – if not it may need to be replaced.	🔧 24V Motor solenoid 0880050015
The machine will not lift bins, although the motor runs	Bin too heavy	Remove material from bin to reduce the weight.	§1.4 §3.3.1.1
	Pressure-relief valve set too low	Contact your agent for instructions on adjusting the pressure setting.	§3.7.2.2
	3-phase motor running in reverse	Swap two of the phase wires in the power plug (3-phase machines only)	§3.5.1
Cradle will not come down from the fully raised position	Mast sliding block jamming in mast	Lightly lubricant inside of mast, slider block and rollers with silicone spray	§3.3.2.2 🔧 Mast block 0090120001
	Lift ram jamming	Contact your agent for support.	§3.3.2.2 🔧 MT1600 Ram 0230090001
	Faulty up/down switch, wiring, or lowering valve coil	Lowering valve should 'click' when the DOWN and SAFETY buttons are pressed – if not, check the up/down switch, wiring and lowering valve coil.	§3.3.2.1 🔧 Up/down switch 0790050454 🔧 24V Lowering valve Coil 0250090067
Cradle jamming part-way down	Mast bent or damaged	Check and straighten – replace if necessary.	§3.3.2.2
	Tipping guide flap sticking or damaged	Check and rectify – replace if necessary.	§3.3.2.2 🔧 Tipping guide flap 0230040001

3.2 Cleaning

The machine may be cleaned with a low-pressure water jet, a microfiber cloth, and a mild cleaning solution. Cleaning should be carried out with the cradle in the fully-lowered position.

 Do not clean the machine with a high-pressure water jet or waterblaster.

 See §1.9 for IP ratings of the machine and major subcomponents.

3.3 Cradle jams

Occasionally the bin cradle may become jammed at some point in the tipping cycle. This is usually a minor issue which can be easily rectified.

 The cradle is not powered down – it is lowered by gravity alone.

 See §3.7.6 for a schematic diagram of the hydraulic system.

3.3.1 Cradle jams while raising

If the cradle jams while raising the cause may be either an overweight bin, or a mechanical fault, such as a bent tipping guide or misaligned roller.

3.3.1.1 Overweight bin

1. Lower the cradle to ground level and remove the bin.
2. Remove some material from the bin, then try again.

 If the pressure-relief valve is adjusted incorrectly, the cradle can stall even when lifting bins that are within the machine's Safe Working Load as per §1.4. The pressure-relief valve may only be adjusted by a qualified technician, with prior authorisation from Simpro.

3.3.1.2 Mechanical fault

1. If possible, lower the cradle to ground level and remove the bin.
2. Attempt to visually identify the cause of the jamming. The most likely causes are:
 - a. The lifting chain may have derailed from the guide at the top of the mast.
 - b. The mast may have been bent or damaged.
 - c. Lack of lubrication on the follower roller  0090120000, or the main cradle axle
 - d. The roller arm may be pressing against the tipping guide, due to the cradle sitting out of level or being incorrectly adjusted.
3. With the cradle lowered, rectify the problem by straightening and/or realigning the mechanical components as required. If the mast is bent, you may need to contact your agent for support.
4. Run the machine through several full cycles to ensure the problem has been resolved.

3.3.2 Cradle jams while lowering



If the cradle jams on the way down, or has jammed on the way up but will not come down, it may be due to a hydraulic, electrical, or mechanical fault.

3.3.2.1 Hydraulic or electrical fault

When the SAFETY and LOWER buttons are pressed simultaneously, the lowering valve should emit a 'click' sound as it opens. If it does not, the problem may be either a hydraulic or electrical fault.

1. Manually remove the bin if it is safe to do so.
2. Use a forklift or hoist to physically support the cradle in position.

⚠ Never place any part of your body underneath the cradle unless it is securely supported.

3. Remove the powerpack cover.
4. Check that the lowering valve coil  0250090067 is receiving an electrical signal. An LED lamp should glow on the coil plug when the SAFETY and LOWER buttons are pressed simultaneously. If it does not, check the up/down switch and wiring.
5. If the coil is receiving an electrical signal but not opening, it may need to be cleaned:
 - a. Remove the coil from the valve stem.
 - b. Unscrew the lowering valve cartridge.  0250090055
 - c. Clean the cartridge with compressed air.
 - d. Replace the lowering valve components by reversing this procedure.
6. Detach the forklift/hoist from the cradle, and test to see if the cradle lowers correctly.
7. Run the machine through several full cycles to ensure the problem has been properly resolved. If the lowering valve is still not operating correctly, it may need to be replaced – contact your agent.

3.3.2.2 Mechanical fault



If the lowering valve is operating correctly (emits a 'click' sound when the SAFETY and LOWER buttons are pressed), the problem may be a mechanical fault.

1. Manually remove the bin if it is safe to do so.
2. Use a forklift or hoist to physically support the cradle in position.

⚠ Never place any part of your body underneath the cradle unless it is securely supported.

3. Attempt to visually identify the cause of the jamming. The most likely causes are:
 - a. The lifting chain may have derailed from the guide at the top of the mast.
 - b. The mast may have been bent or damaged.
 - c. Lack of lubrication on the follower roller, or the main cradle axle
 - d. The roller arm may be pressing against the tipping guide, due to the cradle sitting out of level or being incorrectly adjusted.
4. Rectify the problem by straightening and/or realigning the mechanical components as required. If the mast is bent, you may need to contact your agent for support.
5. Detach the forklift/hoist from the cradle, and test to see if the cradle lowers correctly.
6. Run the machine through several full cycles to ensure the problem has been resolved.

3.4 Electrical System (battery)

-  If you do not operate a battery-powered machine, please disregard this section.
-  Prior to October 2021, battery Multi-Tips were fitted with a single 12V/20Ah VRLA battery.

From 2022, standard Multi-Tips are fitted with two 12V/20Ah GEL batteries connected in series to output 24VDC, a digital smart charger, and a series-wound 24VDC/800W motor. The control voltage is 24VDC.

The motor only runs when the RAISE button is pressed – the cradle is lowered by gravity alone. As a rule, a full charge is sufficient to empty 5 tonnes of material, but this is dependent on the tipping height and the condition of the batteries.

3.4.1 International conformance

The Multi-Tip onboard charger accepts 85-264VAC 50/60Hz 1-phase input, and connects using a widely-available IEC C13 power lead (also known as a computer cord). This means the machine can be charged using regular household power outlets in almost any region.

3.4.2 Voltmeter 0790050067

The Multi-Tip is fitted with a voltmeter on the control panel, which is used to indicate the level of charge in the batteries. **When the voltmeter reads less than 24.0V the batteries are flat.** The machine should not be used, and should be placed on charge as soon as possible.

-  The voltage will fluctuate when the motor is running, so the battery state should be checked when the machine is at rest.

-  Operating a machine with a flat battery may trigger the circuit breaker (see §3.4.7). If this is bypassed, the wiring, battery and motor may be damaged by excessive current draw.

3.4.3 Batteries 0250050004

From 2022, Multi-Tips are fitted with two 12V/20Ah GEL batteries connected in series to deliver 24VDC (nominal) to the motor and control circuits.

The batteries are sealed, deep-cycle, and maintenance-free, with a lifespan of up to five years. However, battery life is dependent on several factors, including the number of charge cycles, the average discharge depth, and environmental conditions.

3.4.3.1 Maximising battery life

To maximize the life of the batteries, observe the following rules:

- Place the batteries on charge each night and over the weekend, even if they are already fully charged.
- Do not allow the batteries to remain fully discharged for more than 24 hours.
- Do not try to operate the machine when the batteries are fully discharged.

-  The batteries are supplied with a 12-month manufacturer's warranty, separate from the warranty on the rest of the machine.

3.4.4 Battery charger 24V Charger 0390050006 12V Charger 0410050039

The Multi-Tip is fitted with a digital smart charger which accepts 1-phase mains power at voltages of 85-264VAC and frequencies of 50/60Hz, with a maximum current draw of 3 Amps.

The charger outputs up to 6 Amps of continuous direct current at 27.2 Volts, for a maximum power output of 160 Watts.

 The battery charger is in an enclosed plastic case and is protected against short-circuit, current overload, over-voltage, and over-temperature.

3.4.5 Charging lead NZ/AU 0790050218 UK 0790050103 US 0790050008

The Multi-Tip uses an IEC C13 charging lead, which connects to the IEC C14 socket on the side of the machine. IEC leads are used for many computer accessories and are widely available from electronics stores. They are sometimes called “computer cords”.

3.4.6 Emergency stop 0790050393



From 2022, the Multi-Tip is fitted with an Emergency Stop button beside the charging socket. This button disconnects battery from the electrical systems, and should be depressed if the machine is to be placed in storage, or any time the powerpack cover needs to be removed.

 Multi-Tips produced prior to 2022 with fitted with a battery-isolator switch with a red key. On certain versions, the battery will not charge if the isolator switch is turned OFF.

3.4.7 Circuit breaker 0790050374

The Multi-Tip is fitted with an auto-resetting 75A circuit breaker on the battery cable to protect the electrical systems from excessive current draw. Once triggered, the circuit breaker will automatically reset after a period of 1-2 minutes.

 Because the current draw of the motor increases as the battery voltage decreases, operating the Multi-Tip with a flat battery may trip the circuit breaker.

 Prior to 2022, the Multi-Tip was fitted with a 120A Maxi blade fuse  0790050107 instead of a circuit breaker. Replacement fuses are available from Simpro and most auto-parts stores.

3.4.8 Solar panel 24V Solar Kit 0090040076 24V Panel Only 0250050530 Regulator 0250050462

 If you do not operate a machine with a solar panel, please disregard this section.

Battery machines may be fitted with a solar panel kit to allow operation in locations without mains power. The 80W monocrystalline solar panel (dimensions 930x673x35mm) is mounted on an adjustable steel bracket at the top of the mast, and delivers power to the battery via a 12V/24V digital regulator.

As set out in §1.5, in ideal conditions the solar panel provides enough power to dump about 2,000kg of material each day, which is equivalent to about 20 full 240-litre wheelie bins. There are many factors affecting this figure, including the season, the amount of sunlight available, cloud cover, panel alignment and cleanliness, and the condition of the battery.

 To deliver maximum power the solar panel must be correctly aligned, clean, and exposed to direct sunlight throughout the day.

3.4.8.1 Solar panel alignment

The solar panel is mounted on an adjustable steel bracket with one axis of movement. To deliver maximum power, the panel should be aligned to cast the largest-possible shadow when the sun is at its highest point in the sky. However, because the bracket has only one axis of movement, the orientation of the machine itself affects the optimum panel alignment.

Use the following guidelines to align the solar panel:

1. Ideally, orient the machine so that adjustment arc of the panel mounting bracket runs from North to South.
2. If the adjustment arc cannot be oriented North-South, the panel should be angled at 0° degrees (vertical). While this is suitable close to the equator, it will progressively reduce the power output at latitudes beyond ±20° degrees.
3. With the machine in its long-term position, **tilt the panel towards the equator** by the same number of degrees as the machine's geographic latitude.
4. If required, a further 5-10% increase in output can be achieved by tuning the panel alignment for the Summer and Winter months:
 - a. At the beginning of Spring, reduce the angle of the panel so it is equal to the machine's geographic latitude **less 15° degrees**.
 - b. At the beginning of Autumn (Fall), increase the angle of the panel so it is equal to the machine's geographic latitude **plus 15° degrees**.

⚠ The panel angles referred to above are measured in degrees of arc from vertical.
 ⚠ Without correct adjustment the solar panel may deliver as little as 20% of the theoretical maximum output. Correctly adjusting the panel when the machine is installed can increase this figure to ~70%, and adjustment twice a year can increase output to ~75% of the theoretical maximum.

3.4.8.2 Solar panel cleaning

The solar panel should be cleaned every six months, using a microfiber cloth or damp rag.

⚠ Use appropriate height-safety equipment when adjusting or cleaning the solar panel.

3.5 Electrical System (3-phase mains)

⚠ If you do not operate a 3-phase mains machine, please disregard this section.
 ⚠ The 3-phase mains specification is recommended for high-intensity applications.

Machines powered by 3-phase mains electricity are generally the same as other models, but use a 3-phase 2-pole electric motor to drive the hydraulic pump. The control voltage is 24VDC. In some countries an electronic VSD is also fitted in order to provide suitable current to the motor.

The motor only runs when the RAISE button is pressed; the cradle is lowered by gravity alone.

3.5.1 International conformance

The exact specifications of 3-phase machines differ depending on the standard voltage and frequency of 3-phase mains power in the intended country of use.

In locations where 3-phase/~400VAC/50Hz power is standard (NZ/AU/UK/EU and most of Asia) the motor is driven directly by the mains current in 'delta configuration'. In locations where different voltages and frequencies are common (USA, Canada, and parts of South America) an electronic Variable Speed Drive (VSD) is fitted, which modulates the local mains supply and outputs 3-phase/400VAC/50Hz current to the motor in 'star configuration'.

A list of 3-phase power standards used in different countries and territories may be viewed at this web address: <https://www.worldstandards.eu/three-phase-electric-power/>.

 Connecting the machine to a power supply for which it was not designed may damage the motor and electronic components. Consult an electrician if you are unsure.

 If the phase wires in the wall socket or extension lead are configured incorrectly, the 3-phase motor may turn in the reverse direction. Although this does not damage the machine, the cradle will not lift. To change the motor direction, swap over any two of the phase wires in the power plug.

3.5.2 Transformer NZ/AU/UK/EU 0250050123

3-phase machines are fitted with a transformer which outputs 24VDC current to the control systems. The input voltage and frequency are specified to suit standard 3-phase mains power in the intended country of use.

3.6 Electrical System (1-phase mains)

 If you do not operate a 1-phase mains machine, please disregard this section.

Machines powered by 1-phase mains electricity are generally the same as other models, but are fitted with an electronic Variable Speed Drive (VSD), which operates a 3-phase 2-pole electric motor driving the hydraulic pump. The control voltage is 24VDC.

The motor only runs when the RAISE button is pressed; the cradle is lowered by gravity alone.

3.6.1 International conformance

The exact specifications of 1-phase machines differ depending on the standard voltage and frequency of 1-phase mains power in the intended country of use. Both the transformer (§3.6.2) and VSD (§3.6.3) are specified to suit local norms.

A list of 1-phase power standards used in different countries and territories may be viewed at this web address: <https://www.worldstandards.eu/electricity/plug-voltage-by-country/>.

 Connecting the machine to a power supply for which it was not designed may damage the motor and electronic components. Consult an electrician if you are unsure.

3.6.2 Transformer NZ/AU 0250050122

1-phase machines are fitted with a transformer which outputs 24VDC current to the control systems. The input voltage and frequency are specified to suit standard 1-phase mains power in the intended country of use.

3.6.3 Variable Speed Drive

1-phase machines are fitted with an electronic Variable Speed Drive (VSD), which outputs 3-phase/400VAC/50Hz current to the motor in 'star configuration'. The VSD input voltage and frequency are specified to suit standard 1-phase mains power in the intended country of use.

The VSD has many parameters that can be set to suit specific applications. They can be modified or calibrated by a PC that has the appropriate program and cable drivers loaded.

 A joystick controller can be provided with the VSD, allowing progressive control over the lifting speed.

 Residual voltages may be retained in the VSD inverter after it has been disconnected from the power supply. Use extreme caution when servicing electrical components.

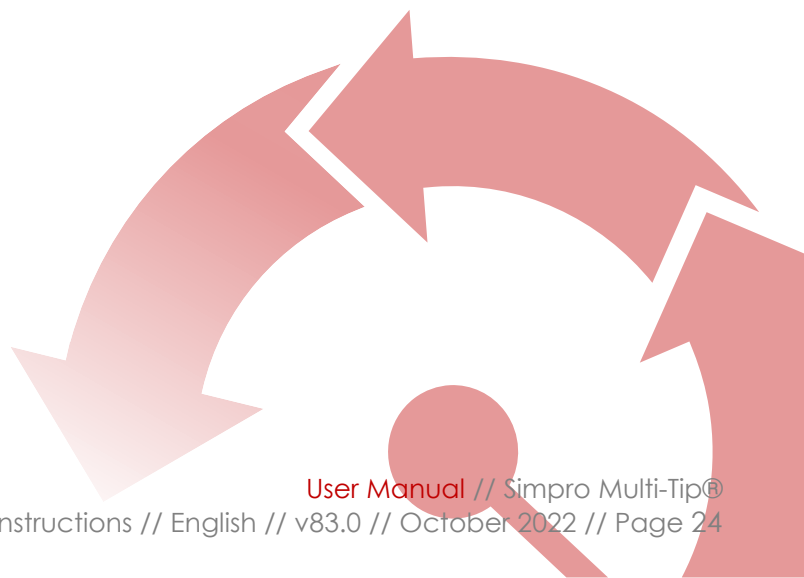

3.7 Hydraulic System

3.7.1 Powerpack 24V 0940090083 12V 0940090067

The hydraulic powerpack is supplied as a complete unit. The motor, pump, oil tank, and all control valves are mounted into the centre manifold.

3.7.2 Control valves

The hydraulic system has four primary control valves:

3.7.2.1 Check valve

This is a one-way valve which prevents oil from flowing back through the pump when the motor is stopped.

3.7.2.2 Pressure-relief valve

This is a spring-loaded valve which allows oil to flow back into the reservoir when the hydraulic pressure exceeds its rated limit – usually from lifting an overweight bin, or from operating the machine when the cradle is already at the top of the cycle.

3.7.2.3 Lowering valve Cartridge 0250090055 Coil 0250090067

This is a solenoid-operated valve which opens when the LOWER button is pressed and allows oil to flow back to the reservoir, lowering the cradle.

3.7.2.4 Lowering-speed valve

This is a pressure-compensating valve which limits the maximum flow rate of oil passing back to the reservoir through the lowering valve – thus regulating the descent speed of the cradle (regardless of the weight of the bin).

3.7.3 Lift ram MT1200 0230090000 MT1600 0230090001 MT1800 0230090127

The lift ram is a single-acting displacement type, very robust and reliable, but easy to maintain should the need arise. Hydraulic lines run from the powerpack to the lift ram.

3.7.4 Hydraulic fluid

The hydraulic system is designed to use mineral oil-based fluid with a viscosity grade of 22 (ISO VG22). Fluid with a higher viscosity grade may be used, but this will reduce the lowering speed of the cradle and increase the likelihood of jams.

The hydraulic fluid should have physical lubricating and chemical properties as specified by:

- Mineral Oil Based Hydraulic Fluids HL (DIN 51524 part 1)
- Mineral Oil Based Hydraulic Fluids HL P (DIN 51524 part 2)

 Ensure the cradle is completely lowered before replacing the hydraulic fluid.

 The hydraulic reservoir has markings showing the recommended fill level. Do not fill beyond this level unless specifically instructed by the manufacturer.

3.7.5 Maintenance

After every 12 months of operation the hydraulic fluid should be drained and replaced, as per specifications in §3.7.4. The intake suction-filter and the lowering valve should also be removed and cleaned at this time.

 See §3.8 for other preventative maintenance inspection procedures.

3.7.6 Hydraulic system schematic

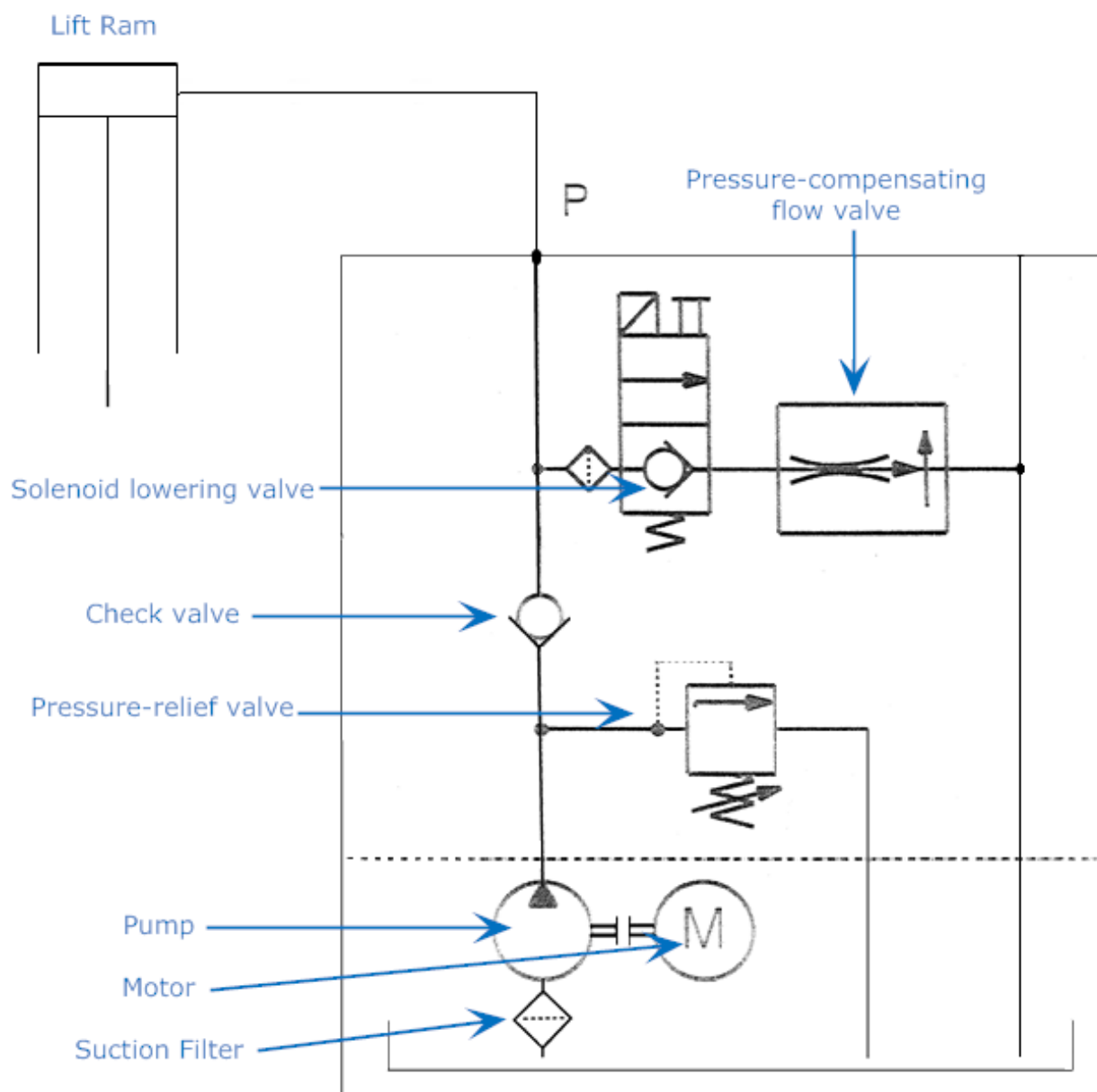

3.8 Preventative Maintenance Inspections

It is recommended to conduct regular preventative maintenance inspections (PMIs) of the Multi-Tip. This helps to ensure operator safety and extend the service life of the machine.

The PMI schedule is divided into two parts: monthly and annual inspections. The PMI procedures are described in the following pages, with logs for recording the results.

- ⚠ Simpro strongly recommends that safety inspections are carried out according to the schedule described in this section.
- ⚠ Operators should immediately stop using the machine and request an inspection if any fault or abnormal operation is observed.

3.8.1 Pre-inspection checklist

1. Wear suitable Personal Protective Equipment (PPE), including safety boots and protective eyewear.
2. Check that there are no ignition sources nearby.
3. Lower the cradle and remove bin.
4. Turn off the key switch and unplug the charging lead.
5. Remove the powerpack cover.
6. Clean the powerpack and electric circuitry with compressed air.
7. Always use height safety equipment when servicing elevated areas.

3.8.2 Monthly inspection

The following inspection should be carried out every month, and the results recorded in the log on the following page.

Monthly Inspection Checklist			
Category	No.	Item	Check
General	1	Entire machine	Visually inspect for dented or broken parts. Carry out a complete tipping cycle, watching for any faults or abnormal behaviour.
Hydraulic systems	2	Hydraulic Ram	Inspect for oil leaks.
	3	Oil Reservoir	Check level of hydraulic fluid and top-up if necessary, as per specifications in §3.7.4.
Safety systems	4	Dual-hand controls	Dual-hand controls are working correctly – machine stops instantly when SAFETY button is released.
Mechanical systems	5	Inside of mast	Lightly lubricate with silicone spray.
	6	Follower Roller 🌀 0090120000	
	7	Cradle Axle	
	8	Tipping Guide Flap 🌀 0230040001	Flap is undamaged and moving freely.
	9	Castor Wheels	All castors 🌀 Braked 0250040090 🌀 Unbraked 0250040087 running smoothly and both brakes working correctly.

Date	Service Person	Location	Checks complete	Notes on repairs or maintenance required	Parts and materials used

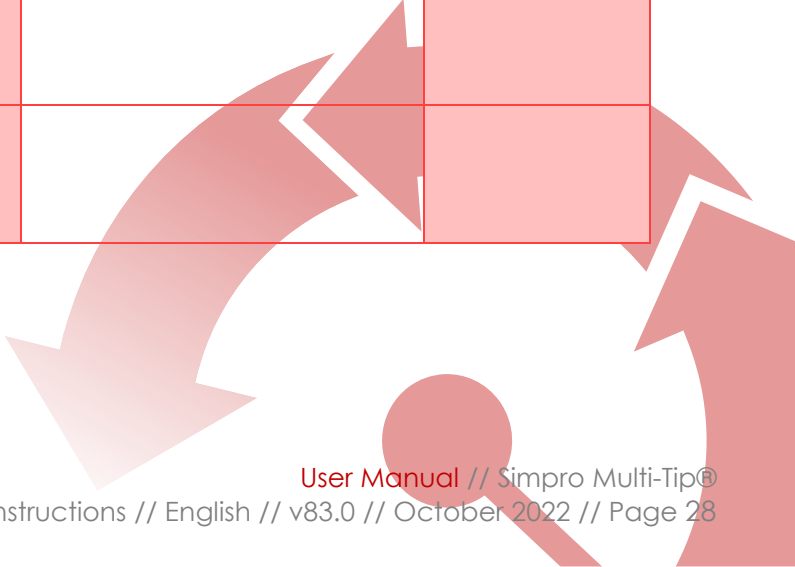

3.8.3 Annual inspection

The following inspection should be carried out every 12 months, and the results recorded in the log on the following page.

Annual Inspection Checklist			
Category	No.	Item	Check
General	1	Entire machine	Visually inspect for dented or broken parts. Carry out a complete tipping cycle, watching for any faults or abnormal behaviour.
Hydraulic systems	2	Hydraulic Ram	Inspect for oil leaks.
	3	Oil Reservoir	Drain and replace hydraulic fluid, as per specifications in §3.7.4. Clean intake suction-filter.
	4	Lowering Valve 🌀 24V Coil 0250090067 🌀 Cartridge 0250090055	Remove and clean.
Electrical systems	5	Charging Lead 🌀 NZ/AU 0790050218 🌀 UK 0790050103	Both plugs are good condition, no frayed or damaged insulation.
Safety systems	6	Dual-hand controls	Dual-hand controls are working correctly – machine stops instantly when SAFETY button is released.
	7	Safety labels and markings	All warnings labels, operation guides etc are attached and legible.
Mechanical systems	8	Mast and cradle	Not twisted or damaged. No cracked or broken welds.
	9	Inside of mast	Lightly lubricate with silicone spray.
	10	Follower Roller 🌀 0090120000	
	11	Cradle Axle	
	12	Tipping Guide Flap 🌀 0230040001	Flap is undamaged and moving freely.
	13	Castor Wheels	All castors 🌀 Braked 0250040090 🌀 Unbraked 0250040087 running smoothly and both brakes working correctly.

Date	Service Person	Location	Checks complete	Notes on repairs or maintenance required	Parts and materials used

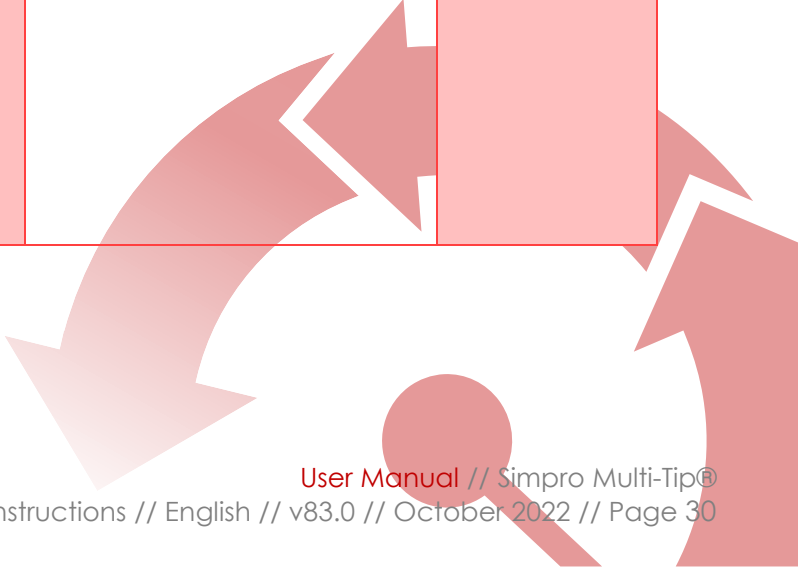

4. Assembly, Handling and Storage

4.1 Assembly

The Multi-Tip is usually delivered fully assembled. However, sometimes the machine may be delivered partially disassembled to minimise volume for shipping. Assembly instructions can be viewed at the following link: <https://support.simpro.world/help/multi-tip-assembly-guide>.

 In some cases, a sealed 'transit plug' is fitted to the hydraulic reservoir to prevent oil leaks during shipping. This must be replaced with the supplied 'breather plug' before the machine is operated, or the reservoir may be damaged.

4.2 Moving

When the Multi-Tip is standing upright it can be easily moved on its castor wheels, using the grab-handle provided. To ensure stability, the cradle should be positioned approximately 100mm off the ground when moving.

 An accessory is available from Simpro which enables a directional lock on the castor wheels. This can make the machine easier to manoeuvre on sloping ground.

 Extra care should be taken when moving the machine on sloping ground.

4.3 Lifting

If the Multi-Tip needs to be lifted for any reason, carry out the following procedure:

1. Check that the lifting equipment is in good condition and rated to lift at least 250kg.
2. Affix a sling or chain to the lifting lug at the top of the mast.
3. Use one person to operate the lifting equipment, and at least one other person to hold the machine steady and watch for hazards.
4. Lift, move and lower the machine into position, ensuring it remains upright at all times.

 The standard Multi-Tip weighs approximately 160kg. Never attempt to lift the machine using equipment with insufficient lifting capacity.

 Never stand or reach underneath the machine while it is being lifted.

4.4 Transport

If the Multi-Tip needs to be transported, carry out the following procedure:

1. Lower the cradle, apply the brakes, and depress the Emergency Stop (on older machines, turn the battery isolator switch OFF).
2. Using a 1-tonne fork truck and the integral fork pockets, place the machine upright onto a wooden pallet. Tie it down with plastic strapping.
3. Load the pallet onto the deck of the transport vehicle.

4. Tie the pallet and machine into place using marked tie-down points and straps rated to at least 1000kg. Make sure it is securely restrained from moving in any direction.

4.4.1 Horizontal transport

It is not recommended to transport the Multi-Tip in horizontal position as this can cause hydraulic fluid leaks, chain derailments and other damage. However, if the machine must be laid over for transport, the additional procedures must be followed:

1. To prevent hydraulic fluid leaks, an impermeable 'transit' plug must be fitted to the oil tank in place of the standard 'breather' plug. Alternatively, the fluid must be drained.
2. To maintain positive tension on the chains and prevent jams, the cradle must be tied or strapped into the fully-lowered position.
3. To minimise the likelihood of damage to the frame and guarding, the machine must only be lain over onto its front (tipping) face.
4. Once the machine has been unloaded and stood back upright, the breather plug must be re-fitted before the machine is operated.

 If the machine is operated with the 'transit' plug still in place, a vacuum will form inside the oil tank, potentially causing it to rupture or collapse.

4.5 Storage

If the machine is not to be used for a period of two months or more, it should be stored in a clean, dry place with good ventilation, at temperatures not below 0°C. Before placing the machine into storage, carry out the following procedure:

1. Carry out two full tipping cycles, then lower the cradle to the ground.
2. Clean the machine thoroughly as per §3.2.
3. Apply a thin layer of silicone lubricant to exposed surfaces of moving parts.
4. Charge the batteries (if fitted) and lubricate the electrical contacts.
5. Depress the Emergency Stop (if fitted) or turn the battery isolator switch OFF.
6. Remove the key and store it in a safe place.

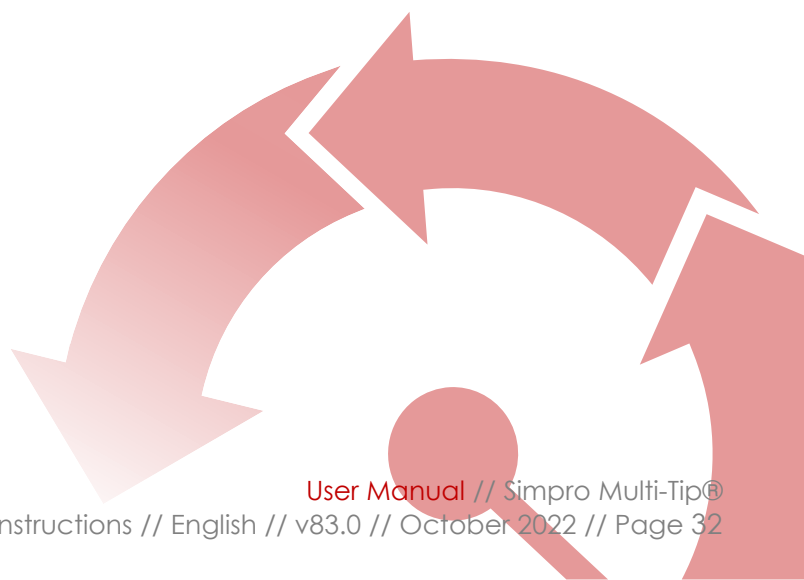

5. Safety Assessment

The Multi-Tip has been designed to be as safe as possible without restricting the ease-of-use and versatility of the machine.

 Before the machine is used for the first time, a site-specific Hazard and Risk Assessment should be completed as per §5.3.

5.1 Safety features

The safety features of the Multi-Tip are as follows:

1. A shrouded dual-hand control system, which immediately stops the cradle whenever the 'Raise', 'Lower' or 'Safety' buttons are released.
2. A welded mesh panel which physically prevents the operator from accessing moving parts while using the machine.
3. A tipping action which maintains the weight of the bin within the machine footprint.
4. A pressure-compensating lowering valve which automatically regulates the lowering speed regardless of the weight of the bin.

5.2 Reasonably foreseeable misuse

The reasonably foreseeable misuse considered in the Multi-Tip design is as follows:

1. Attempts to use the machine by untrained operators;
2. Attempts to empty bins that the cradle is not specifically designed to hold;
3. Attempts to bypass dual-hand controls or other safety systems;
4. Attempts to access the operational area beneath the cradle without following proper procedures;
5. Attempts to clean the machine without following proper procedures.

5.3 Hazard and Risk Assessment Guide

Most jurisdictions require machinery owners to conduct a Hazard and Risk Assessment for their equipment, which considers all relevant factors such as the area it is used, the skill and training of operators, the proximity of other persons, frequency of use, etc.

The following section is not a comprehensive site-specific Hazard and Risk Assessment, but an assessment of the risk factors that are intrinsic to the Multi-Tip design. Blank template spaces are provided for additional site-specific hazards.

 The procedure for carrying out a Hazard and Risk Assessment is typically defined with reference to ISO 12100:2010, issued by the International Standards Organisation. This standard describes procedures for identifying hazards and estimating and evaluating risks during relevant phases of a machine life cycle.

⚠ As with all powered lifting equipment, certain *residual hazards* may be present despite any safety measures that can be implemented by the manufacturer and/or owner. It is essential that operators are aware of these *residual hazards* and what they must do to prevent harm to themselves and to others, as set out in §5.3.3.

5.3.1 The ISO 12100 risk assessment model

In the ISO 12100:2010 risk assessment model, each identified hazard is given a **Risk Factor**, from which is derived a **Risk Evaluation**. These parameters are determined as follows.

5.3.1.1 Determining the Risk Factor

The Risk Factor associated with any given hazard may be calculated from the following table, using the formula: **Risk Factor = LO x FE x DPH x NP**:

LO	Likelihood of Occurrence	FE	Frequency of Exposure	DPH	Degree of Possible Harm	NP	Number of Persons at risk
0.1	Impossible, or possible only in extreme circumstances	0.1	Infrequently	0.1	Scratch or bruise	1	1 – 2 persons
0.5	Highly unlikely though conceivable	0.2	Annually	0.5	Laceration, mild ill-health	2	3 – 7 persons
1	Unlikely but could occur	1	Monthly	1	Break minor bone or illness (temporary)	4	8 – 15 persons
2	Possible but unusual	1.5	Weekly	2	Break major bone or illness (permanent)	8	16 – 50 persons
5	Even chance – could happen	2.5	Daily	4	Loss of 1 limb or eye/serious illness (temporary)	12	51 or more persons
8	Probable, or not surprising	4	Hourly	8	Loss of 2 limbs or eyes/serious illness (permanent)	-	-
10	Likely, or only to be expected	5	Constantly	15	Fatality	-	-
15	Certain, or beyond doubt	-	-	-	-	-	-

5.3.1.2 Evaluating the Risk

Once a Risk Factor has been calculated, the risk can be evaluated using the following table:

Risk Factor	0-1	2-5	6-10	11-50	51-100	101-500	501-1000	1001 +
Evaluation	Negligible	Very Low	Low	Significant	High	Very High	Extreme	Unacceptable

⚠ Risks evaluated as Very High, Extreme or Unacceptable are likely to require additional or updated safety functions, as per §5.4.4. These must be specified at the time of order.

5.3.2 Identified Hazards

The following hazards have been identified that are intrinsic to the Multi-Tip design. For each hazard a full Risk Evaluation has been completed and control measures described.

 Blank template spaces are provided at the end for machinery owners to identify, assess and control additional site-specific hazards.

Entanglement or amputation of fingers or limbs in moving parts										
Operator	LO:	0.5	FE:	4	DPH:	1	NP:	1	Risk Factor:	2
	Operation of the Multi-Tip requires both hands on the control buttons. This means the operator cannot reach any moving parts while using the machine.									
Other persons	LO:	1	FE:	4	DPH:	1	NP:	1	Risk Factor:	4
	The operator has a good view of the cradle while using the machine, and can instantly stop all movement by removing either hand from the control buttons if any persons approach the cradle while moving.									
Control measures	Operators are responsible to obey all instructions and warning signs regarding keeping themselves and others clear of moving parts.									
Comments	The Multi-Tip is designed so trapping hazards are minimized, and both hands are needed to operate the machine.									
Crushing due to unauthorized rapid descent of cradle										
Operator	LO:	0.5	FE:	4	DPH:	2	NP:	1	Risk Factor:	4
	The operator is protected from the cradle by the frame and guarding during operation. There is nothing to stop an operator or other person moving under the cradle while it is inverted. Significant safety margins ensure that the probability of failure of any steel, hydraulic, or control parts failing is low.									
Other persons	LO:	0.5	FE:	4	DPH:	2	NP:	1	Risk Factor:	4
	As above.									
Control measures	Operators are responsible to obey all instructions and warning signs regarding keeping themselves and others away from the area beneath the cradle while it is raised. The machine must be regularly maintained, and all faults repaired immediately.									
Comments	A hydraulic speed-control valve limits the maximum speed of descent in normal use.									
Operator or others being hit by falling or flying debris										
Operator	LO:	2	FE:	4	DPH:	0.5	NP:	1	Risk Factor:	4
	The operator is protected from the cradle by the frame and guarding during operation. There is some risk if product such as broken glass is being tipped.									
Other persons	LO:	1	FE:	2	DPH:	0.5	NP:	1	Risk Factor:	1
	There is some risk if product such as broken glass is being tipped.									
Control measures	Operators are responsible to obey all instructions and warning signs regarding keeping other persons away from the machine while in use. If tipping items such as glass, metal or liquids, glasses and gloves should be worn.									
Comments										

Crushing due to machine falling over										
Operator	LO:	1	FE:	4	DPH:	8	NP:	1	Risk Factor:	32
	Relatively low risk as the Multi-Tip is very stable, and the bin's centre of gravity remains well within the machine's footprint throughout the tipping cycle.									
Other persons	LO:	1	FE:	1	DPH:	8	NP:	1	Risk Factor:	8
	As above.									
Control measures	Do not operate on soft ground, or ground with slope ratio greater than 1:12. Never attempt to empty liquids from closed-top drums.									
Comments										
Electrocution or electric shock										
Operator	LO:	0.5	FE:	4	DPH:	15	NP:	1	Risk Factor:	30
	Some risk is always present with mains leads.									
Other persons	LO:	0.5	FE:	4	DPH:	15	NP:	1	Risk Factor:	30
	As above.									
Control measures	Ensure a Residual Current Device (RCD) is fitted to all power sockets. Check all leads frequently and repair or replace if damaged. All leads should be checked and tagged by a registered electrician at regular intervals.									
Comments	Mains-powered Multi-Tips are earthed and comply with AS60204.1. The charger on battery-powered Multi-Tips is double-insulated.									
Illness caused by tipping toxic powder and liquid										
Operator	LO:	1	FE:	4	DPH:	1	NP:	1	Risk Factor:	4
	Great care should be taken when tipping powder or liquids. If the product could cause any harm whatsoever to the operator or to any other person, ensure all persons are well protected.									
Other persons	LO:	0.5	FE:	4	DPH:	1	NP:	2	Risk Factor:	4
	As above.									
Control measures	The operator must wear appropriate protective equipment, and ensure that all other persons are well clear of the area. Powder should only be tipped when there is no wind, and/or a wind shield should be installed.									
Comments	Toxic substances that cannot be protected against with PPE should not be dumped using a Multi-Tip. Alternative methods should be used.									
Damage to skin when used in extreme weather conditions										
Operator	LO:	2	FE:	4	DPH:	1	NP:	1	Risk Factor:	8
	If the machine is to be used in extreme cold or heat, the operator must wear gloves and other suitable Personal Protective Equipment.									
Other persons	LO:	2	FE:	4	DPH:	1	NP:	1	Risk Factor:	8
	As above.									
Control measures	Operators are responsible to wear Personal Protective Equipment suitable for the environment in which the machine is being used.									
Comments	See §1.8 for Multi-Tip environmental restrictions.									



Site-specific hazard:										
Operator	LO:		FE:		DPH:		NP:		Risk Factor:	
Other persons	LO:		FE:		DPH:		NP:		Risk Factor:	
Control measures										
Comments										
Site-specific hazard:										
Operator	LO:		FE:		DPH:		NP:		Risk Factor:	
Other persons	LO:		FE:		DPH:		NP:		Risk Factor:	
Control measures										
Comments										
Site-specific hazard:										
Operator	LO:		FE:		DPH:		NP:		Risk Factor:	
Other persons	LO:		FE:		DPH:		NP:		Risk Factor:	
Control measures										
Comments										
Site-specific hazard:										
Operator	LO:		FE:		DPH:		NP:		Risk Factor:	
Other persons	LO:		FE:		DPH:		NP:		Risk Factor:	
Control measures										
Comments										

5.3.3 Residual Hazards

As with all industrial lifting equipment, some **residual hazards** may be present despite any interlocks, guarding or other safety functions that can be fitted to the machine.

The machinery owner has a legal responsibility to take **all reasonable precautions** to eliminate, isolate, or minimize these residual hazards. This may include:

- Monitoring and enforcing the training of operators
- Design and implementation of Standard Operating Procedures
- Using rewards and/or disciplinary measures to encourage safe behaviours
- Posting signage, floor marking, or other warnings as appropriate
- Encouraging a culture of safety within the workplace

5.4 OSH Compliance Specification Guide

Companies in most jurisdictions (including Australia, NZ, UK, USA, Canada, and the EU) are required by law to provide a safe workplace for their staff, including ensuring that all new and existing machinery is safe to operate.

Although the particulars of safety legislation differ, most countries accept that machinery is 'safe to operate' if it can be demonstrated to **comply with ISO 13849-1:2015** (or an equivalent local standard).

ISO 13849-1:2015 may call for additional guarding, interlocks, and other safety features, depending on the particular conditions of use. The following section is provided to assist potential Dumpmaster operators in determining whether any additional safety features are required for their application.

 ISO 13849-1:2015 is a machinery-safety standard issued by the International Standards Organisation. It provides safety requirements and guidance on the principles for the design and integration of safety-related parts of control systems (SRP/CS), including the design of software.

 ISO 13849-1 has been modified for local conditions and reissued under different terminology by some national standards authorities. In Australia and New Zealand, the derivative standard is called AS/NZS 4024.1:2014.

 In the USA, ANSI standards are commonly used to demonstrate the safety of machinery, rather than ISO 13849-1. However, since the US model relies largely on 'best practise' and 'liability' to enforce workplace H&S norms, US companies who demonstrate machinery safety using ISO 13849-1 may be considered to have met their H&S obligations.

5.4.1 The ISO 13849 functional safety model

Unlike the *system architecture* model used by earlier safety standards, ISO 13849-1:2015 uses a *functional safety* model of machinery safety. That means it takes account of the reliability of parts as well as other factors to create a comprehensive measure of the risk reduction achieved by a safety function – an indicator called **Performance Level (PL)**.

The standard defines five Performance Levels, ranging from **PLa** (lowest performance) to **PLe** (highest performance).

The standard also defines the Performance Level that a given safety function must achieve to reduce the risk to an acceptable level – a value called **Performance Level required (PLr)**.

5.4.2 Identifying the required safety functions

To identify the safety functions required for a given machine, a site-specific hazard and risk assessment must first be completed as per §5.3. Identified hazards that cannot be avoided or eliminated must be addressed by appropriate safety functions.

5.4.3 Determining the Performance Level required (PLr)

As defined by the ISO 13849-1:2015 safety model, the minimum PLr for any given safety function is derived from three parameters:

1. Severity of injury expected from the associated hazard
2. Frequency and/or duration of exposure to the associated hazard
3. Possibility of manually avoiding the associated hazard

The following table may be used to determine the minimum PLr from these parameters.

Safety Function PLr Determination Table			
Severity of injury expected from hazard	Frequency and/or duration of exposure to hazard	Possibility of manually avoiding the hazard	Min PLr
Slight injury (reversible)	Seldom to quite often and/or short exposure time	Possible under specific conditions	PL(a)
		Scarcely possible	
	Frequent to continuous and/or long exposure time	Possible under specific conditions	PL(b)
		Scarcely possible	
Serious injury or death (irreversible)	Seldom to quite often and/or short exposure time	Possible under specific conditions	PL(c)
		Scarcely possible	
	Frequent to continuous and/or long exposure time	Possible under specific conditions	PL(d)
		Scarcely possible	PL(e)

To demonstrate compliance with ISO 13849-1:2015, the minimum acceptable PLr of the safety functions must be assessed for each identified hazard **in the specific conditions in which the machine is to be used**.

 Safety function performance may be assessed as part of the regular Hazard and Risk Assessment set out in §5.3. Although this assessment includes all hazards intrinsic to the Multi-Tip design, other safety functions may be required to address site-specific hazards, which can be evaluated using the blank spaces provided.

5.4.4 Achieving the Performance Level required (PLr)

Because all hazards intrinsic to the Multi-Tip design are addressed by safety functions with a baseline performance of PLc, it follows that additional or updated safety functions are only required in the following cases:

1. The risk assessment identifies application-specific hazards which are not addressed by the safety functions built into the standard Multi-Tip design.
2. The risk assessment identifies application-specific hazards which are sufficiently serious and/or frequent as to require safety functions with a performance level of PLd or PLe.

3. The operating environment is subject to corporate policies, union contracts, OSH regulations or other external factors which specify that all machinery must have a safety performance level of PLd or PLe.

In any of these cases, information about the hazard and risk assessment, required safety function and performance level should be provided to Simpro before placing an order.

Simpro can then specify and quote additional or updated safety functions, such as:

- Upgrade of control system architecture to Category 3 or Category 4
- Additional guarding
- Remote controls
- Training of operators
- Custom signage or floor markings

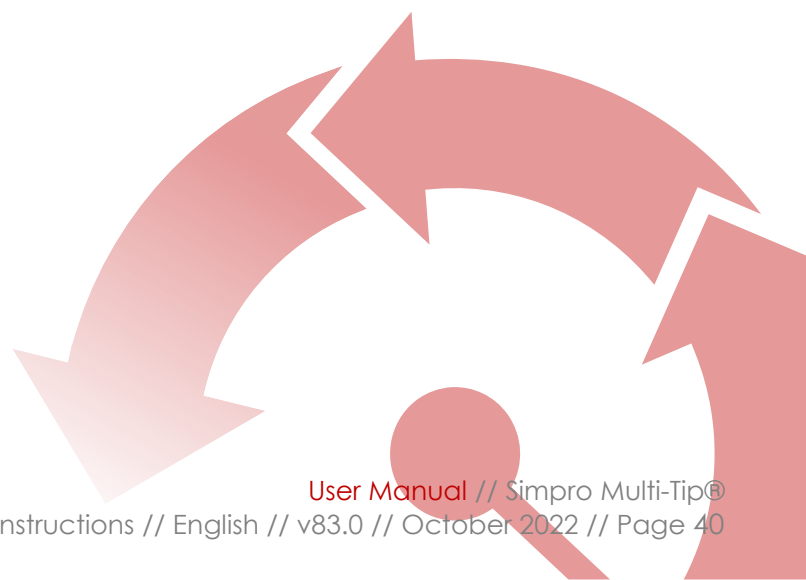

6. Spare Parts

The following table includes only the most common Multi-Tip spare parts as at the time of publication. Additional parts, accessories and prices may be viewed at the following web address: simpro.world/multi-tip-spare-parts

	Partcode	Description	Qty*	BSK†	ASK‡
All models	0790050373	Key-Switch, 2-position, stay-put, with 2 x N/O contact blocks	1	✓	✓
	0790050067	Voltmeter, 12-24VDC, blue LCD readout (serials ≥ S4920 only)	1	✓	✓
	0790050454	Up/Down Switch, dual push-button, booted, with 2x N/O contact blocks	1	✓	✓
	0790050005	Safety Button, green, booted, with 1x N/O contact block	1	✓	✓
	0790050261	Contact Block, N/O (for key-switch and raise/lower switches)	5	✓	✓
	0090090006	Ram Seal, 1in x 1¼in x ¼in (PU + NBR O-ring)	1	✓	✓
	0140120002	Ram Roller, standard, nylon	1	✓	✓
	0230090000	Ram, Ø1in x 675mm stroke, no rollers (MT1200 only)	1		
	0070010036	Roller chain, ½" BS Simplex, 87 links (MT1200 only)	1		
	0230090001	Ram, Ø1in x 875mm stroke, no rollers (MT1600 only)	1		
	0070010037	Roller chain, ½" BS Simplex, 119 links (MT1600 only)	1		
	0230090127	Ram, Ø1in x 975mm stroke, no rollers (MT1800 only)	1		
	0070010032	Roller chain, ½" BS simplex, 135 links (MT1800 only)	1		
	0090120001	Mast Block, nylon, 68x25mm	4		✓
	1000000303	Gas Strut Assembly (for top of mast)	1		✓
	0230040001	Tipping Guide Flap, stainless steel	1		
	0090120000	Follower Roller, ø50mm x 35mm wide, unbushed	1	✓	✓
	0400020168	Wheel Catch Plate, single, for EN840 wheelie bins (Type-E cradle only)	2		
	0250040090	Castor, 125mm, braked	2		✓
	0250040087	Castor, 125mm, unbraked	2		✓
0250090055	Lowering Valve Cartridge	1			
24V models only (serials S6701 and above)	0250090067	Lowering Valve Coil, 24VDC	1	✓	✓
	0880050015	Motor Solenoid, 24V/200A	1	✓	✓
	0880050040	Motor Kit, 800W/24VDC, with adaptor ring and spindle	1		
	0940090083	Powerpack complete, 24VDC, 0.8cc pump, 2L horizontal tank	1		✓
	0250050004	Battery, 12V/20Ah GEL (two batteries in series to output 24VDC)	2		
	0390050006	Battery Charger, 24V/6A, GC160A24-AD1	1	✓	✓
	0790050393	Emergency Stop, 250A, heavy-duty	1		✓
	0790050374	Circuit Breaker, 75A, auto-resetting	1		✓
12V models only (serials S6700 and below)	0250050049	12V LED battery indicator (serials < S4920 only)	1	✓	✓
	0250090064	Lowering Valve Coil, 12VDC	1	✓	✓
	0880050017	Motor Solenoid, 12V/200A	1	✓	✓
	0880050030	Motor Kit, 800W/12VDC, with adaptor ring and spindle	1		
	0940090067	Powerpack & motor complete, 12VDC, 0.8cc pump, 2L horizontal tank	1		✓
	0250050004	Battery, 12V/20Ah GEL (one battery only outputting 12VDC)	1		
	0410050000	Battery Charger, 12V/7.2A, PB-120N-13C (serials < S0231 only)	1	✓	✓
	0410050039	Battery Charger, 12V/10A, GC160A12-AD1 (serials S0231-S6700 only)	1	✓	✓
	0390050000	Battery Isolator Switch, 100A Cont/500A Int, with red key	1	✓	✓

* Quantity per machine

† Basic spares kit

‡ Advanced spares kit

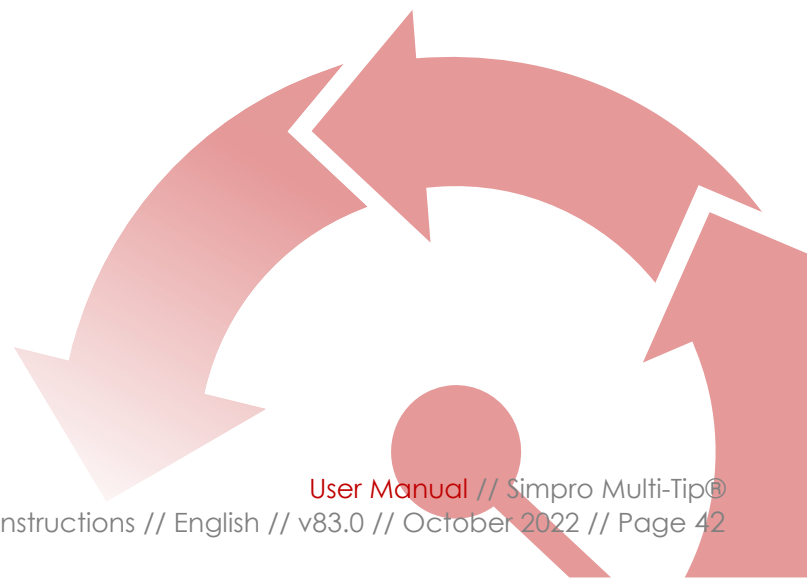

7. Warranty

7.1 Definitions

1. "Simpro" means Simpro Handling Equipment Limited, [New Zealand Company No. 1827916](#).
2. "Agent" means a person or company authorized by Simpro to sell a Product.
3. "Service Agent" means a person or company authorized by Simpro to repair a Product.
4. "End User" means the first purchaser of a Product from a Sales Agent authorised by Simpro to sell the Product.
5. "Warranty" means the commitment that Simpro has to guarantee the workmanship and componentry to any End User of Products manufactured and sold by Simpro.
6. "Warranty Claim" means an application from an Agent to Simpro to be reimbursed for expenses relating to repairs done to remedy a fault with a Simpro Product.
7. "Warranty Period" means the length of time that Simpro undertakes to guarantee a Product.
8. "Back to Base" means that the costs associated with the transporting of a Product between the Service Agent and the End User is the End Users responsibility.
9. "Standard Products" means any Product displayed as a standard product on the Simpro website, [simpro.world](#).
10. "Part" and "Parts" refer to components of a Product.
11. "Minor Fault" means a fault or defect that requires less than one hour to rectify
12. "Instruction Handbook" means a document so titled that provides brief information and guidance on the operation of the Product for commonly performed functions.
13. "Service Manual" means a document so titled that provides comprehensive information and guidance for service, repairs, and maintenance.
14. "Warranty Registration Process" means the process of an End User registering their product with Simpro. This may be done using the web form here: [simpro.world/warranty-registration](#)
15. "Application for Warranty Consideration Form" means the system used to file a Warranty Claim with Simpro. This may be done using the web form here: [simpro.world/warranty-claim](#).

7.2 Coverage

1. Simpro provides a 12 month Back to Base Warranty on all Standard Products unless alternative terms have been agreed to in writing.
2. The Warranty terms and conditions on custom-built and non-standard machines are generally specified on quotations, and placing an order implies acceptance of the Warranty terms. If no specific Warranty details have been provided, the standard terms and conditions will apply.
3. The 12-month Warranty period shall be taken from the date the machine first leaves the Agent's premises, whether sold or just supplied for trial. The Agent shall keep accurate records of the date of all machine trials, sales, etc.
4. Simpro will, at its option, repair or replace any items that fail or prove defective within the Warranty period.
5. Simpro's liability under the terms of this Warranty shall be limited to remedying any fault that occurs on machines it has manufactured or supplied, and shall not cover any consequential loss or damage.
6. The Warranty on batteries is for 12 months only, and is distinct from the warranty on the rest of the machine. Information on maximising battery life is provided in the User Manual.

7.3 Exclusions

1. Simpro will not recognise a Warranty Claim against a machine where payment to Simpro for that machine is outstanding. If a Warranty Claim is made before payment is due, the full payment must be made on the due date. The Warranty Claim, if accepted, will be credited at a later date.
2. Warranty Claims may not be recognized unless the [Warranty Registration Process](#) has been completed. If not done at the time of sale, this should be done at the time of the Warranty Claim. If warranty registration has not been completed, proof of purchase may be required.
3. Damage caused or contributed to by misuse, abuse, accident, unauthorised repairs or modifications, or failure to use the machine in accordance with instructions is specifically excluded.

4. Travelling time and mileage are specifically excluded from the Simpro warranty coverage. However, under certain circumstances Simpro at its discretion may contribute to these costs. Authorisation must be obtained from Simpro prior to any such Warranty Claim. This does not prohibit an Agent offering more extensive Warranty cover, outside of this Warranty, as negotiated between the Agent and the End User.

7.4 End User claim procedure

1. Where a fault or breakdown appears to have occurred the End User should, if applicable, first consult the Quick Troubleshooting Guide section of the User Manual provided with each machine, to ascertain the cause of the fault and remedy if possible. This information may also be accessed on the Simpro Support website: support.simpro.world.
2. If the fault is not able to be remedied, the End User should contact the Agent who sold the machine, and explain as fully as possible the fault, including all relevant factors such as:
 1. Did the fault occur suddenly, or develop over a period of time?
 2. Was the machine being used at the time?
 3. Is the fault intermittent?
 4. Are the batteries fully charged?
3. If repair is urgent, or the Agent cannot be contacted, the End User may contact Simpro directly.

7.5 Agent claim-handling procedure

1. Upon receiving notification of a fault, the Service Agent should attempt to determine the cause and a course of action before going to see the machine.
2. The Service Agent should contact Simpro for assistance in identifying the fault, if it is not apparent. This step is important, so that if a site visit is necessary, the correct tools and spare Parts can be taken. It is also important to establish whether there may have been any negligence, misuse or an accident that contributed to or caused the fault.
3. Parts requiring replacement will be supplied by Simpro free of charge; in some cases, it may be necessary to source Parts locally if needed urgently, but Simpro must authorize this if the cost of the item exceeds \$50.00 and is to be charged to Simpro.
4. If the fault is not a Minor Fault, the Agent must notify Simpro and receive authorization to proceed before the repair work is done. Simpro will assist in every way possible, including discussing the problem directly with the End User if necessary, to determine the best method of effecting the repair in the shortest time possible.
5. Upon completion of the repair to an acceptable standard, the Agent shall complete the [Application For Warranty Consideration Form](#) and include copies of any invoices for labour, and any Parts supplied.
6. The cost of Warranty repairs is not to be deducted from any payments due to Simpro, unless Simpro issues a credit note clearly stating the amount and which invoice it relates to.
7. Simpro undertakes to be reasonable in respect of all Warranty repairs undertaken by Agents, but reserves the right to decline payment for:
 1. Work done or materials replaced that were not authorized in advance by Simpro.
 2. Work not done to an acceptable standard.
 3. Work taking an unduly long time, due (in part or in full) to the lack of knowledge or skill of the serviceman or the Agent. The time allowed for repair work will be based on Simpro's assessment of what a reasonably skilled technician would take. A detailed Service Manual is available on request from Simpro, and all service visits should be conducted with this document at hand.

This warranty shall be interpreted according to the laws of New Zealand, and the parties agree to submit to the jurisdiction of the Courts of New Zealand.

8. EC Declaration of Conformity



DECLARATION OF CONFORMITY

ORIGINAL

Business Name and Full Address of Manufacturer

Simpro Handling Equipment Ltd
66 Rangī Road, Takanini 2105
Auckland, New Zealand

Name and Address of Authorised Representative

As above

Name and Address of the Person in Community Authorised to compile the Technical File (if different to above)

Safe Machine Limited
DBH Business Centre, Coxwold Way, Billingham, Tees Valley TS23 4EA UK

Description of product (Commercial Name)

Simpro Multi-Tip

Function, Model, Type, Serial Number

Function: Bin Tipper
Type: Electro-hydraulic

Model: MT1200 / MT1600 / MT1800
Serial No:

Standards Used

EN 349 1993, EN 574 1996+A1:200, EN 953 1997, EN ISO 4413 2010, EN ISO 12100 2010, EN ISO 13849-1 2006, EN ISO 13857 2008, EN 60204 2006+A1 2009, EN 61000-6-2 2005, EN 61000-6-4 2007

Place of Declaration

66 Rangī Road, Takanini 2105
Auckland, New Zealand

Date of Declaration:

24 February 2018

Declaration

I declare that the machinery fulfils all the relevant provisions of the following Directives:- Machinery Directive 2006/42/EC, Electromagnetic Compatibility Directive 2004/108/EC.

Person Empowered to Draw Up Declaration

Name: Daniel Craig Currie

Position: Business Development Manager

Signature:

Declaration No: 002



9. Notes

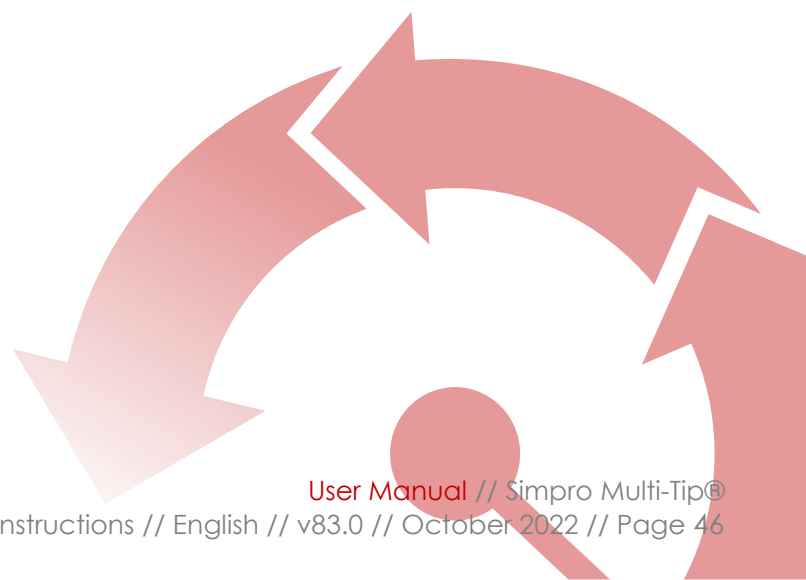

 Simpro has been supplying Smart Lifting solutions for over 30 years. Founded in 1986 as a light engineer, the company has since built a unique position in the supply chain for specialist materials-handling equipment - from bin lifters and crate stackers to electric forklifts.

With business activities including design, manufacture, import, export, wholesale and retail, Simpro products now play a quiet role for thousands of companies around the world. Customers range from SMEs to bluechips, operating in sectors as diverse as warehouse logistics, food processing and waste management.

Simpro's OEM products are now sold around the world through a distribution network covering most large economies. The product range continues to evolve thanks to a policy of continuous R&D, new ideas and new partnerships.

Simpro is a family company, based in Auckland and registered with the New Zealand Companies Office as Simpro Handling Equipment Ltd (1827916).

This document may contain intellectual property belonging to Simpro, including patents, trademarks and/or registered designs.

 66 Rangi Road
Takanini 2105
Auckland, New Zealand

 PO Box 74
Takanini 2245
Auckland, New Zealand

 +64 9 634 7445

 sales@simpro.world

 shop.simpro.world

 @simpro.world

 @SimproWorld_Lifters

