

SGLOCKS

Newsletter

SEP / OCT 2025
ISSUE 122

PART TWO



LOCKTON

GUARD WHAT MATTERS



INDEX



Mortice Lock Range

Pages 26-37



Mortice Lock Furniture

Pages 38-51



Door Closers

Pages 52-63



Panic Bar Kits

Pages 63-65



Knob & Leversets

Pages 64-75



Deadbolt Range

Pages 74-75



Re-Keyable Padlocks

Pages 76-87



Blocker Plate Range

Pages 88-89



Fire-Rated Hinges

Pages 90-92



Swing Bolt Range

Pages 93



Display Boards

Pages 94-95



Cylinders

Pages 96-108



Smart Gateways

Page 97



Smart Keypads

Page 98



Smart Door Locks

Pages 102-109



Screen Door Locks

Pages 110-111



Digital Door Locks

Page 114



Key Tags

Page 115



Door Stoppers

Pages 116-117



LOCKTON

GUARD WHAT MATTERS



LOCKTON

The LOCKTON range of security products is made from the highest quality materials with state-of-the-art manufacturing and quality control.

With a comprehensive and ever-growing range of Commercial Hardware including; Mechanical & Electronic Door Locks, Padlocks, Door Closers, Hinges and other Door Hardware. LOCKTON has a solution for your locking needs.

The Griffin is a mythical creature, part lion and part eagle, which has been known throughout history as a protector and guardian. The Griffin is symbolic of both power and bravery & is often portrayed as guarding treasure or wealth.

LOCKTON & its Griffin are your protector & guardian.

GUARD WHAT MATTERS



LOCKTON

E - S e r i e s



LOCKTON

commercial



LOCKTON

ESSENTIALS



Art ID: SG-ML60



LOCKTON 60mm Mortice Lock

PRODUCT DESCRIPTION

The LOCKTON 60mm mortice lock body and latch are made from 304 Stainless Steel, making them not only extremely tough and durable, but also extremely weather resistant to the harsh Australian environment.

The LOCKTON SG-ML60 retrofits Australian standard 60mm mortice locks and comes with the required fixing screws, strikes, cylinder retaining pins, turn snib adapter, templates and instructions.

PRODUCT SPECIFICATION

- Easy change Lock Functions - turn the dial on the side of the lock body (Consistent with the LOCKTON 23 mm Backset & 30 mm Backset Mortice Locks)
- Accepts Australian Oval Cylinder
- Easy close action for electric strikes
- Uses industry standard cams
- 4-hour fire rating
- 10-year warranty
- Cycle tested
- Fits doors between 32-50 mm
- Suits left & right opening doors
- Electric strike compatible



BLACK

Art ID: SG-ML60-BLK



4-Hours



SL8 : Physical Security Rating



D8 : Durability Rating (500,000 Cycles)



Design for Access and mobility - AS1428.1-2009



10 YEAR WARRANTY
EVERYDAY LOW PRICE!

LOCKTON 95mm Mortice Lock

PRODUCT DESCRIPTION

The LOCKTON 95mm mortice lock body and latch are made from 304 Stainless Steel, making them not only extremely tough and durable, but also extremely weather resistant to the harsh Australian environment.

The LOCKTON SG-ML95 retrofits Australian standard 95mm mortice locks and comes with the required fixing screws, strikes, cylinder retaining pins, turn snib adapter, templates and instructions.

PRODUCT SPECIFICATION

- 'Easy Change' Lock Functions - turn the dial on the side of the lock body (Consistent with the LOCKTON 23, 30 & 60mm Backset Mortice Locks)
- Kick off function
- Accepts Australian oval cylinder (like the LOCKTON 410 Range)
- Easy close action for electric strikes
- Uses industry standard cams
- 2-Hour fire rating
- 10 year warranty
- Cycle tested
- Fits doors between 32-50mm
- Suits left & right opening doors
- Electric strike compatible.



2-Hours



Design for Access and mobility - AS1428.1-2009





Art ID: SG-ML60-DB

QTY
5

LOCKTON 60mm DEADBOLT Mortice Lock

PRODUCT DESCRIPTION

The LOCKTON 60mm mortice lock body and bolt are made from 304 Stainless Steel, making them not only extremely tough and durable, but also extremely weather resistant to the harsh Australian environment.

The LOCKTON SG-ML60-DB retrofits Australian standard 60mm mortice Dead bolt locks and comes with the required fixing screws, strike, cylinder retaining pins, templates and instructions.

PRODUCT SPECIFICATION

- Accepts Australian oval cylinder (like the LOCKTON 410 Range)
- Uses industry standard (N) cams
- Supplied with Art. ADAPTOR-Y Mortice Lock Adaptor & Art. CAM-N Mortice Lock Cam (see RELATED PRODUCTS)
- 10 year warranty
- Fits doors between 32-50 mm
- Suits left & right opening doors.



Art ID: SG-ML60-SLD

QTY
5

LOCKTON 60mm SLIDING Mortice Lock

PRODUCT DESCRIPTION

The LOCKTON 60mm mortice lock body and latch are made from 304 Stainless Steel, making them not only extremely tough and durable, but also extremely weather resistant to the harsh Australian environment.

The LOCKTON SG-ML60-SLD retrofits Australian standard 60mm mortice Sliding Door locks and comes with the required fixing screws, strike, cylinder retaining pins, templates and instructions.







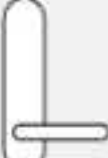
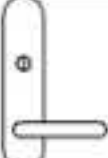

PRODUCT SPECIFICATION

- Accepts Australian oval cylinder (like the LOCKTON 410 Range)
- Uses industry standard (N) cams
- Supplied with Art. ADAPTOR-Y Mortice Lock Adaptor & Art. CAM-N Mortice Lock Cam (see RELATED PRODUCTS)
- 10 year warranty (*)
- Fits doors between 32-50 mm
- Suits Sliding doors.





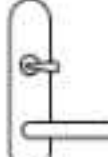







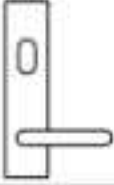

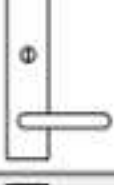

Round Plate Furniture

	Description	External Furniture	Internal Furniture
	CYL HOLE & LEVER	RND-01C-25-SCP	RND-01V-25-SCP
	LEVER ONLY	RND-02C-25-SCP	RND-02V-25-SCP
	EMERGENCY TURN & LEVER	RND-03C-25-SCP	-
	CYL HOLE ONLY	RND-04C-SCP	RND-04V-SCP
	DUAL ENTRY	RND-10C-SCP	-
	SNIB & LEVER	-	RND-13V-25-SCP
	DA TURN SNIB & LEVER	-	RND-13VDA-25-SCP
	EMERGENCY TURN, INDICATOR & LEVER	RND-53C-25-SCP	-
	INDICATING DA TURN SNIB & LEVER	-	RND-63VDA-25-SCP
	OFFSET D HANDLE / CYL HOLE	RND-04V-OSET-D-SC	

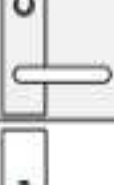
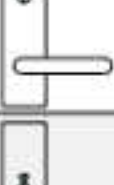

Square Plate Furniture

	Description	External Furniture	Internal Furniture
	CYL HOLE & LEVER	SQ-01C-25-SCP SQ-01C-25-BLK	SQ-01V-25-SCP SQ-01V-25-BLK
	LEVER ONLY	SQ-02C-25-SCP SQ-02C-25-BLK	SQ-02V-25-SCP SQ-02V-25-BLK
	EMERGENCY TURN & LEVER	SQ-03C-25-SCP SQ-03C-25-BLK	-
	CYL HOLE ONLY	SQ-04C-SCP SQ-04C-BLK	SQ-04V-SCP SQ-04V-BLK
	PLAIN PLATE	SQ-05C-SCP	SQ-05V-SCP SQ-05V-BLK
	DA SNIB ONLY (DB & SLD)	-	SQ-06VDA-2-SCP SQ-06VDA-2-BLK
	INDICATING DA SNIB Only	-	SQ-07VDA-SCP SQ-07VDA-BLK
	DUAL ENTRY	SQ-10C-SCP SQ-10C-BLK	-
	SNIB & LEVER	-	SQ-13V-25-SCP SQ-13V-25-BLK
	DA TURN SNIB & LEVER	-	SQ-13VDA-25-SCP SQ-13VDA-25-BLK
	EMERGENCY TURN, INDICATOR & LEVER	SQ-53C-25-SCP SQ-53C-25-BLK	-
	EMERGENCY TURN, INDICATOR Only	SQ-59C-SCP SQ-59C-BLK	-
	INDICATING DA TURN SNIB & LEVER	-	SQ-63VDA-25-SCP SQ-63VDA-25-BLK
	OFFSET D HANDLE / CYL HOLE	SQ-04V-OSET-D-SC SQ-04V-OSET-D-BLK	-
	OFFSET D HANDLE / PLAIN	SQ-05V-OSET-D-SC SQ-05V-OSET-D-BLK	-



'60mm' Square Plate Mortice Lock Kits - Satin Chrome







	Kit Number	Function	Art ID.	Ordering Options
	KIT 1	CLASSROOM	ML60-KIT1	ALB KA KD 
	KIT 2	ENTRANCE	ML60-KIT2	KA KD ALB 
	KIT 3	PASSAGE	ML60-KIT3	- 
	KIT 4	DOUBLE CYLINDER	ML60-KIT4	ALB KA 
	KIT 5	DISABILITY	ML60-KIT5	ALB KA KD 
	KIT 6	INDICATING DA & CYL	ML60-KIT6	ALB KA KD 
	KIT 7	INDICATING DA TOILET	ML60-KIT7	- 

'60mm' Square Plate Mortice Lock Kits - **BLACK**

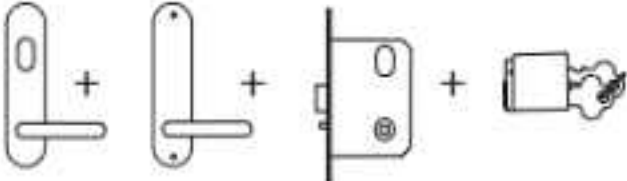
	Kit Number	Function	Art ID.	Ordering Options
	KIT 1	CLASSROOM	ML60-KIT1-BLK	KD KA 
	KIT 2	ENTRANCE	ML60-KIT2-BLK	KA KD 
	KIT 3	PASSAGE	ML60-KIT3-BLK	- 
	KIT 4	DOUBLE CYLINDER	ML60-KIT4-BLK	KA 
	KIT 5	DISABILITY	ML60-KIT5-BLK	KA KD 
	KIT 6	INDICATING DA & CYL	ML60-KIT6-BLK	KA KD 
	KIT 7	INDICATING DA TOILET	ML60-KIT7-BLK	- 



'60mm' Round Plate Mortise Lock Kits - Satin Chrome

	Kit Number	Function	Art ID.	Ordering Options
	KIT 1	CLASSROOM	ML60-RND-KIT1	ALB KA KD 
	KIT 2	ENTRANCE	ML60-RND-KIT2	ALB KA KD 
	KIT 3	PASSAGE	ML60-RND-KIT3	- 
	KIT 4	DOUBLE CYLINDER	ML60-RND-KIT4	ALB KA 
	KIT 5	DISABILITY	ML60-RND-KIT5	ALB KA KD 





Round Rose Furniture- Universal furniture

	Description	External / Internal Furniture
	PASSAGE FURNITURE SET	CYL-53-25-SCP CYL-53-25-BLK
	PRIVACY FURNITURE SET	CYL-53-25-P-SCP CYL-53-25-P-BLK
	OVAL CYLINDER ESCUTCHEON	CYL50-OVL CYL50-OVL-BLK

Round Rose Furniture - External Furniture

	Description	External Furniture
	INDICATING EMERGENCY RELEASE	CYL50-EM-TRN CYL50-EM-TRN-BLK

Round Rose Furniture - Internal Furniture

	Description	Internal Furniture
	INDICATING DA TURN SNIB	CYL50-15VDA-SNB-2 CYL50-15VDA-SNB-2-BLK
	TURN SNIB ESCUTCHEON	CYL50-SNB CYL50-SNB-BLK



Heavy Duty '60mm' Backset Latches - for Round Rose

	Description	Art ID.
 	PRIVACY BOLT	CYL-BOLT-TB60-SS CYL-BOLT-TB60-BLK
 	PASSAGE LATCH	CYL-PSG-TL60-SS CYL-PSG-TL60-BLK
 	PRIVACY LATCH	CYL-PRIV-TL60-SS CYL-PRIV-TL60-BLK



'60mm' Round Rose Mortice Lock Kits - Satin Chrome

	Kit Number	Function	Art ID.	Ordering Options
	KIT 1	CLASSROOM	ML60-CYL-KIT1	ALB KA KD 
	KIT 2	ENTRANCE	ML60-CYL-KIT2	ALB KA KD 
	KIT 3	PASSAGE	ML60-CYL-KIT3	- 
	KIT 4	DOUBLE CYLINDER	ML60-CYL-KIT4	ALB KA 
	KIT 6	INDICATING DA & CYL	ML60-CYL-KIT6	ALB KA KD 
	KIT 7	INDICATING DA TOILET	ML60-CYL-KIT7	- 

'60mm' Round Rose Mortice Lock Kits - **BLACK**

	Kit Number	Function	Art ID.	Ordering Options
	KIT 1	CLASSROOM	ML60-CYL-KIT1-BLK	KA KD 
	KIT 2	ENTRANCE	ML60-CYL-KIT2-BLK	KA KD 
	KIT 3	PASSAGE	ML60-CYL-KIT3-BLK	- 
	KIT 4	DOUBLE CYLINDER	ML60-CYL-KIT4-BLK	KA 



**'60mm' Deadbolt - Mortice Lock Kits - Satin Chrome
-Wide Plate furniture**

	Kit Number	Function	Art ID.	Ordering Options	
	KIT 4	DOUBLE CYLINDER	ML60DB-KIT4	ALB KA	
	KIT 6	INDICATING DA & CYL	ML60DB-KIT6	ALB KA KD	
	KIT 7	INDICATING DA TOILET	ML60DB-KIT7	-	

**'60mm' Deadbolt - Mortice Lock Kits - Satin Chrome
- Wide Plate Furniture - With Push/Pull Hardware**

	Kit Number	Function	Art ID.	Ordering Options	
	KIT 6	INDICATING DA & CYL	ML60DB-KIT6-PPP	ALB KA KD	
	KIT 7	INDICATING DA TOILET	ML60DB-KIT7-PPP	-	



'60mm' Deadbolt - Mortice Lock Kits - BLACK
- Wide plate Furniture

	Kit Number	Function	Art ID.	Ordering Options
	KIT 4	DOUBLE CYLINDER	ML60DB-KIT4-BLK	KA 
	KIT 6	INDICATING DA & CYL	ML60DB-KIT6-BLK	KA KD 
	KIT 7	INDICATING DA TOILET	ML60DB-KIT7-BLK	- 

'60mm' Deadbolt - Mortice Lock Kits - BLACK
- Wide Plate Furniture - With Push/Pull Hardware

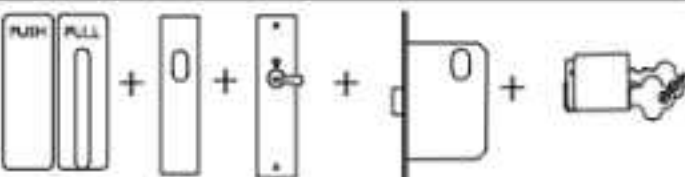
	Kit Number	Function	Art ID.	Ordering Options
	KIT 6	INDICATING DA & CYL	ML60DB-KIT6-PPP-BLK	KA KD 
	KIT 7	INDICATING DA TOILET	ML60DB-KIT7-PPP-BLK	- 

'60mm' Deadbolt - Mortice Lock Kits - Satin Chrome
- Round Rose Furniture

	Kit Number	Function	Art ID.	Ordering Options
	KIT 4	DOUBLE CYLINDER	ML60DB-CYL-KIT4	KA ALB 
	KIT 6	INDICATING DA & CYL	ML60DB-CYL-KIT6	KA KD ALB 
	KIT 7	INDICATING DA TOILET	ML60DB-CYL-KIT7	- 

'60mm' Deadbolt - Mortice Lock Kits - BLACK
- Round Rose Furniture

	Kit Number	Function	Art ID.	Ordering Options
	KIT 4	DOUBLE CYLINDER	ML60DB-CYL-KIT4-BLK	KA 

'60mm' Deadbolt - Mortice Lock Kits - Satin Chrome
- Round Rose - With Push/Pull Hardware

	Kit Number	Function	Art ID.	Ordering Options
	KIT 6	INDICATING DA & CYL	ML60DB-CYL-KIT6-PPP	KA KD ALB 
	KIT 7	INDICATING DA TOILET	ML60DB-CYL-KIT7-PPP	- 



'60mm' Sliding - Mortice Lock Kits - Satin Chrome
-Wide Plate furniture

	Kit Number	Function	Art ID.	Ordering Options	
	KIT 4	DOUBLE CYLINDER	ML60SLD-KIT4	ALB KA	
	KIT 6	INDICATING DA & CYL	ML60SLD-KIT6	ALB KA KD	
	KIT 7	INDICATING DA TOILET	ML60SLD-KIT7	-	

'60mm' Sliding - Mortice Lock Kits - Satin Chrome
- Wide Plate Furniture - With Push/Pull Hardware

	Kit Number	Function	Art ID.	Ordering Options	
	KIT 6	INDICATING DA & CYL	ML60SLD-KIT6-PPBL	ALB KA KD	
	KIT 7	INDICATING DA TOILET	ML60SLD-KIT7-PPBL	-	



'60mm' Sliding - Mortice Lock Kits - BLACK
- Wide plate Furniture

	Kit Number	Function	Art ID.	Ordering Options
	KIT 4	DOUBLE CYLINDER	ML60SLD-KIT4-BLK	KA 
	KIT 6	INDICATING DA & CYL	ML60SLD-KIT6-BLK	KA KD 
	KIT 7	INDICATING DA TOILET	ML60SLD-KIT7-BLK	- 

'60mm' Sliding - Mortice Lock Kits - BLACK
- Wide Plate Furniture - With Push/Pull Hardware

	Kit Number	Function	Art ID.	Ordering Options
	KIT 6	INDICATING DA & CYL	ML60SLD-KIT6-PPBL-BLK	KA KD 
	KIT 7	INDICATING DA TOILET	ML60SLD-KIT7-PPBL-BLK	- 

'60mm' Sliding - Mortice Lock Kits - Satin Chrome
- Round Rose Furniture

	Kit Number	Function	Art ID.	Ordering Options
	KIT 4	DOUBLE CYLINDER	ML60SLD-CYL-KIT4	KA ALB 
	KIT 6	INDICATING DA & CYL	ML60SLD-CYL-KIT6	KA KD ALB 
	KIT 7	INDICATING DA TOILET	ML60SLD-CYL-KIT7	- 

'60mm' Sliding - Mortice Lock Kits - BLACK
- Round Rose Furniture

	Kit Number	Function	Art ID.	Ordering Options
	KIT 4	DOUBLE CYLINDER	ML60SLD-CYL-KIT4-BLK	KA 

'60mm' Sliding - Mortice Lock Kits - Satin Chrome
- Round Rose - With Push/Pull Hardware

	Kit Number	Function	Art ID.	Ordering Options
	KIT 6	INDICATING DA & CYL	ML60SLD-CYL-KIT6-PPBL	KA KD ALB 
	KIT 7	INDICATING DA TOILET	ML60SLD-CYL-KIT7-PPBL	- 



Art ID: SG-SBML23

QTY
\$

LOCKTON 23mm Mortice Lock

PRODUCT DESCRIPTION

Retrofits most Australian 23mm Backset Latching Mortice Locks
 Accepts Australian Oval Cylinders
 Includes Turn Snib Adapter, Fixing Screws, Strike Plate and Instructions
 Easy Close Action for Electric Strikes
 Uses Industry Standard Cams
 Electric Strike Compatible
 10 Year Warranty



PRODUCT SPECIFICATION

- Latch: Stainless Steel (Reversible)
- Mortice Lock (Body ONLY) is 38.5mm deep, this does NOT include the face plate

BLACK



Art ID: SG-SBML23-BLK

QTY
\$



Art ID: SG-SBML30

QTY
\$

LOCKTON 30mm Mortice Lock

PRODUCT DESCRIPTION

Retrofits most Australian 30mm Backset Latching Mortice Locks
 Accepts Australian Oval Cylinders
 Includes Turn Snib Adapter, Fixing Screws, Strike Plate & Instructions
 Easy Close Action for Electric Strikes
 Uses Industry Standard Cams
 Electric Strike Compatible
 10 Year Warranty



PRODUCT SPECIFICATION

- Latch: Stainless Steel (Reversible)

BLACK



Art ID: SG-SBML30-BLK

QTY
\$

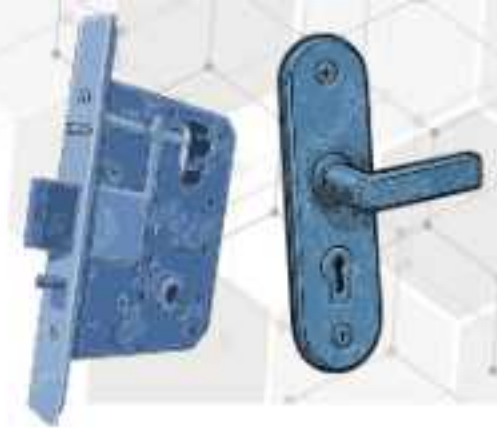







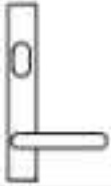

Narrow Round Plate Furniture







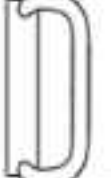

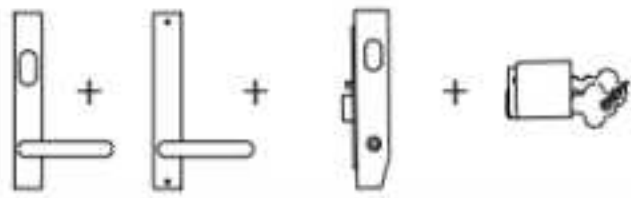

	Description	External Furniture	Internal Furniture
	CYL HOLE & LEVER	NRND-01C-25-SCP	NRND-01V-25-SCP
	LEVER ONLY	NRND-02C-25-SCP	NRND-02V-25-SCP
	CYL HOLE ONLY	NRND-04C-SCP	NRND-04V-SCP
	DUAL ENTRY	NRND-10C-SCP	-
	SNIB & LEVER	-	NRND-13V-25-SCP
	DA TURN SNIB & LEVER	-	NRND-13VDA-25-SCP
	OFFSET D HANDLE / CYL HOLE	NRND-04V-OSET-D-SC	-

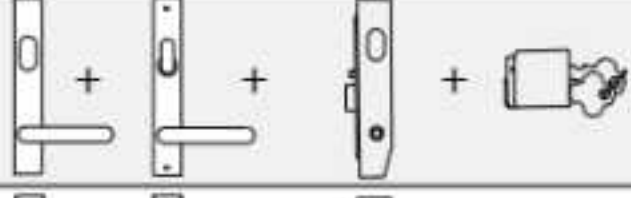

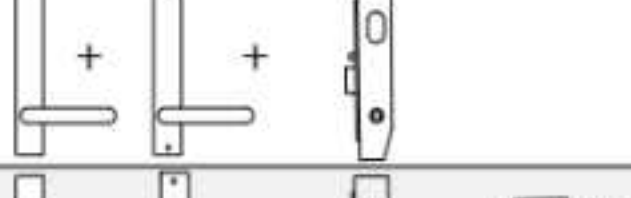
Narrow Square Plate Furniture



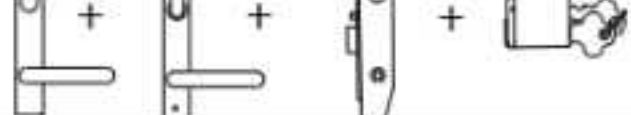



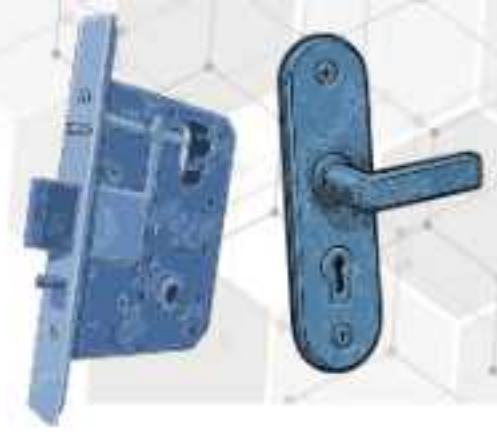

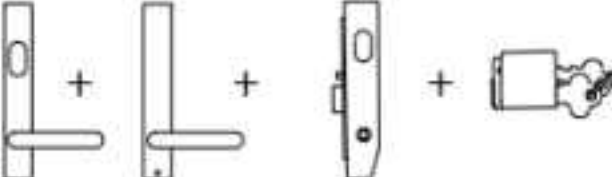

	Description	External Furniture	Internal Furniture
	CYL HOLE & LEVER	NSQ-01C-25-SCP NSQ-01C-25-BLK	NSQ-01V-25-SCP NSQ-01V-25-BLK
	LEVER ONLY	NSQ-02C-25-SCP NSQ-02C-25-BLK	NSQ-02V-25-SCP NSQ-02V-25-BLK
	CYL HOLE ONLY	NSQ-04C-SCP NSQ-04C-BLK	NSQ-04V-SCP NSQ-04V-BLK
	PLAIN PLATE	NSQ-05C-SCP	NSQ-05V-SCP NSQ-05V-BLK
	DUAL ENTRY	NSQ-10C-SCP NSQ-10C-BLK	-
	SNIB & LEVER	-	NSQ-13V-25-SCP NSQ-13V-25-BLK
	DA TURN SNIB & LEVER	-	NSQ-13VDA-25-SCP NSQ-13VDA-25-BLK
	OFFSET D HANDLE / CYL HOLE	NSQ-04V-OSET-D-SC NSQ-04V-OSET-D-BLK	-
	OFFSET D HANDLE / PLAIN	NSQ-05V-OSET-D-SC NSQ-05V-OSET-D-BLK	-

'23mm' Narrow Stile Mortice Lock Kits - Satin Chrome

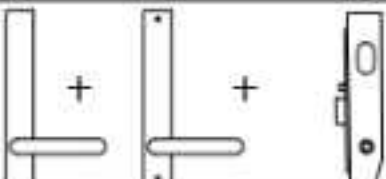

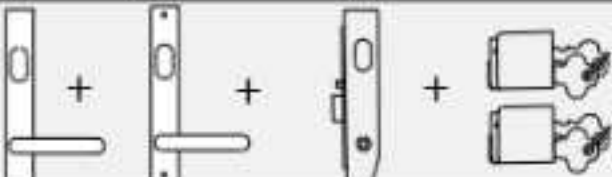

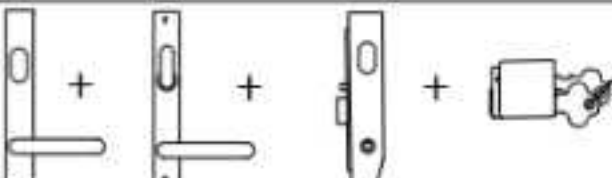
	Kit Number	Function	Art ID.	Ordering Options
	KIT 1	CLASSROOM	SBML23-KIT1	ALB KA KD 
	KIT 2	ENTRANCE	SBML23-KIT2	ALB KA KD 
	KIT 3	PASSAGE	SBML23-KIT3	- 
	KIT 4	DOUBLE CYLINDER	SBML23-KIT4	ALB KA 
	KIT 5	DISABILITY	SBML23-KIT5	ALB KA KD 



'23mm' Narrow Stile Mortice Lock Kits - **BLACK**

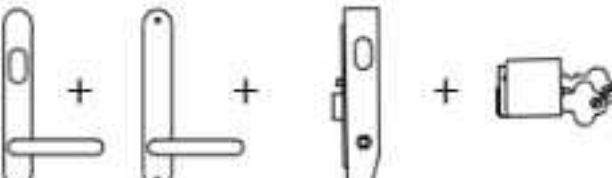



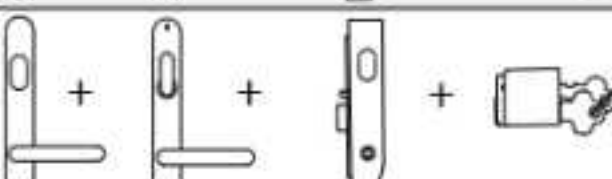

	Kit Number	Function	Art ID.	Ordering Options
	KIT 1	CLASSROOM	SBML23-K1-BLK	KA KD 
	KIT 2	ENTRANCE	SBML23-K2-BLK	KA KD 
	KIT 3	PASSAGE	SBML23-K3-BLK	- 
	KIT 4	DOUBLE CYLINDER	SBML23-K4-BLK	KA 
	KIT 5	DISABILITY	SBML23-K5-BLK	KA KD 

'23mm' Round Narrow Stile Mortice Lock Kits - Satin Chrome

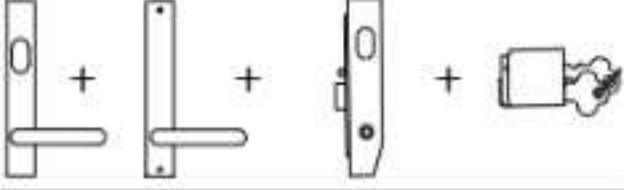
	Kit Number	Function	Art ID.	Ordering Options
	KIT 1	CLASSROOM	SBML23-RND-K1	ALB KA KD 
	KIT 2	ENTRANCE	SBML23-RND-K2	ALB KA KD 
	KIT 3	PASSAGE	SBML23-RND-KIT3	- 
	KIT 4	DOUBLE CYLINDER	SBML23-RND-K4	ALB KA 
	KIT 5	DISABILITY	SBML23-RND-K5	ALB KA KD 

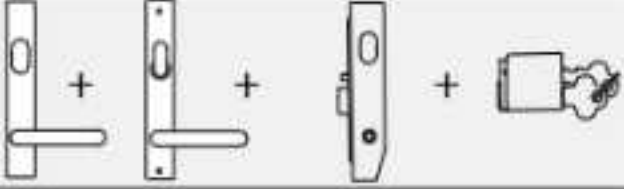

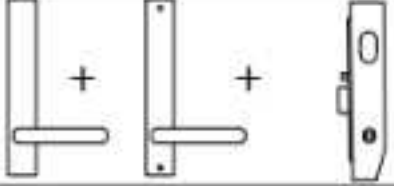
'30mm' Narrow Stile Mortice Lock Kits - Satin Chrome

	Kit Number	Function	Art ID.	Ordering Options
	KIT 1	CLASSROOM	SBML30-KIT1	ALB KA KD 
	KIT 2	ENTRANCE	SBML30-KIT2	ALB KA KD 
	KIT 3	PASSAGE	SBML30-KIT3	- 

'30mm' Narrow Stile Mortice Lock Kits - **BLACK**

	Kit Number	Function	Art ID.	Ordering Options
	KIT1	CLASSROOM	SBML30-K1-BLK	KA KD 
	KIT2	ENTRANCE	SBML30-K2-BLK	KA KD 

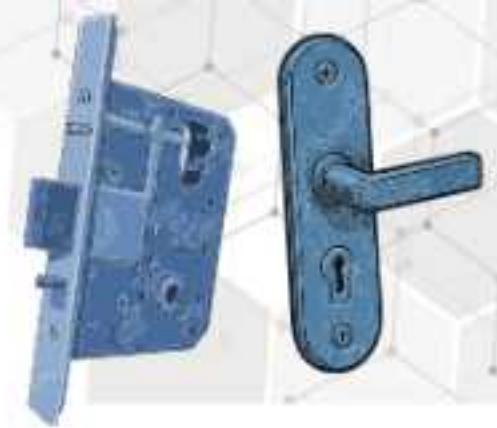

2-Hours



D8 : Durability Rating
(500,000 Cycles)



Design for Access and
mobility - AS1428.1-2009

Innovative Design

Retrofits existing common
Square Plate ML Furniture

Economical

Reduced stock holding
Carry the most common
'162 SERIES' configurations,
and be 'ready to retrofit'

'162 SERIES' Square Plate Furniture

PRODUCT DESCRIPTION

LOCKTON '162 SERIES' Square plate door furniture is designed to retrofit both common types of Plate furniture currently available on the market.

It can be used with Art. SG-ML60 & SG-ML95 mortice locks or most existing common mortice locks.

'162 SERIES' can now be kept as stock due to its economical price point & flexibility to be used with new installs & retrofitting.

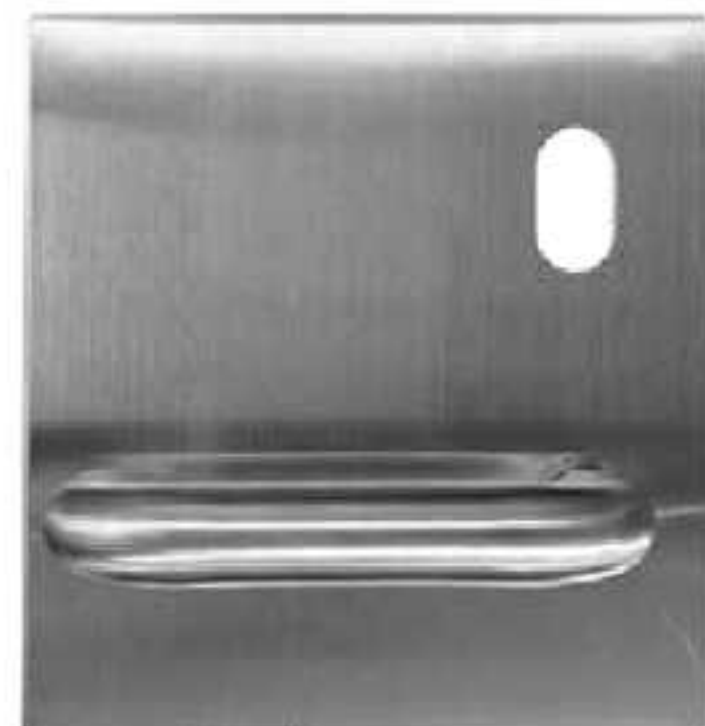

Suitable for use in all heavy traffic areas including:

- Commercial
- Education
- Retail
- Industrial
- Medical
- Government

PRODUCT SPECIFICATION

- Material: 316 Stainless Steel
- Finish: Satin Stainless Steel
- Dimensions: 166mm (H) x 166mm (W) x 2mm (T).
- Handing: Left & Right-handed (see images & chart for specifying)
- Door Thickness: 35mm-50mm
- Warranty: 10-Year warranty



FURNITURE SELECTION GUIDE

FURNITURE SELECTION: Select based on the orientation of the LOCK on the DOOR when standing in front of it.

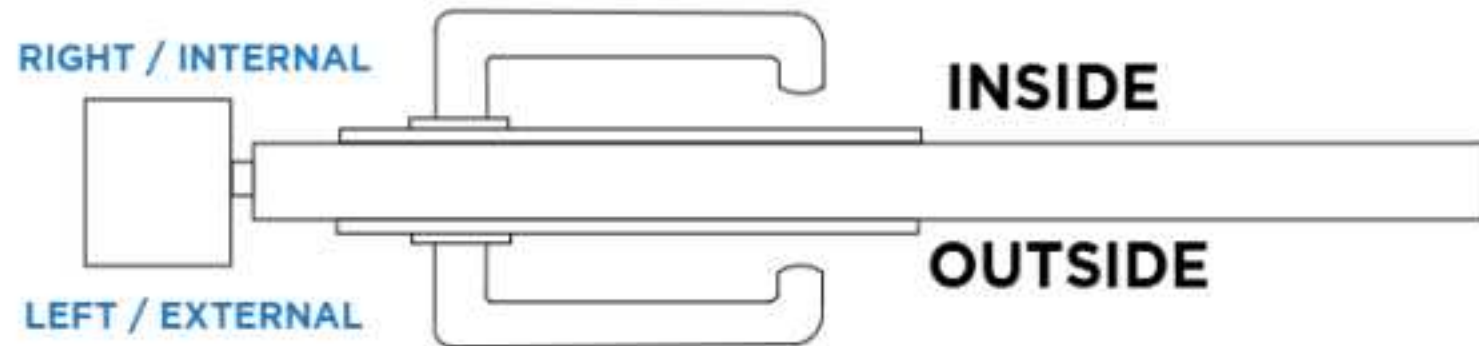

Example:

When **OUTSIDE** and LOCK is **LEFT** Side of Door; Select **LEFT** Handed **EXT.** Furniture
 When **INSIDE** and LOCK is **RIGHT** Side of Door; Select **RIGHT** Handed **INT.** Furniture

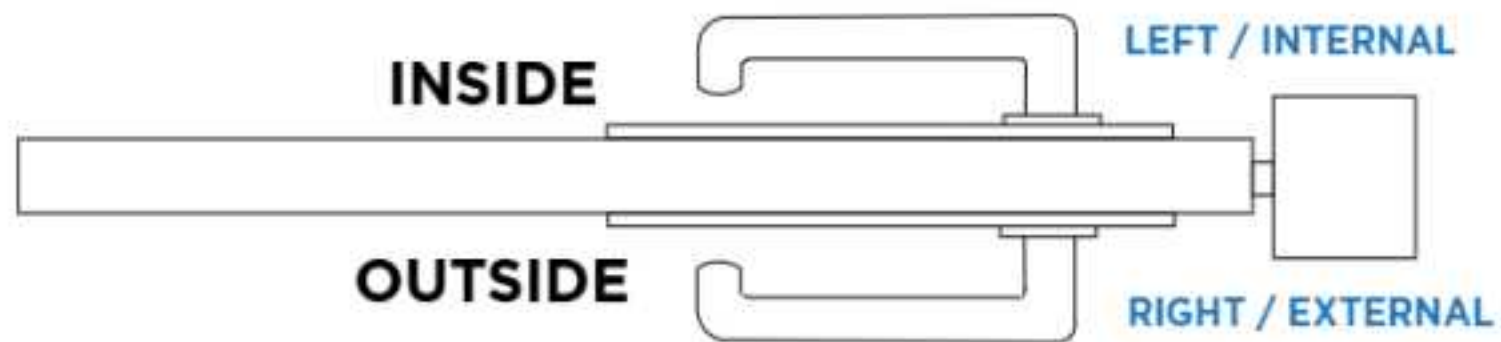

Example:

When **OUTSIDE** and LOCK is **RIGHT** Side of Door; Select **RIGHT** Handed **EXT.** Furniture
 When **INSIDE** and LOCK is **LEFT** Side of Door; Select **LEFT** Handed **INT.** Furniture

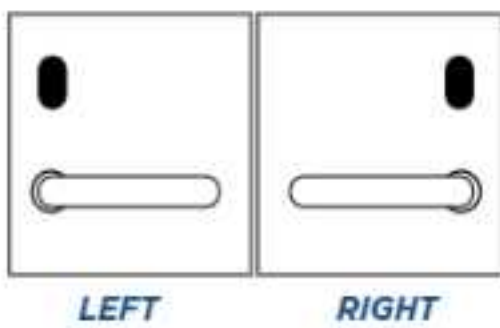

'162 Series' SQ. EXTERNAL PLATE

Art ID.	Description
PSQ-01C-25-S-L	CYL HOLE & LEVER - LEFT
PSQ-01C-25-S-R	CYL HOLE & LEVER - RIGHT

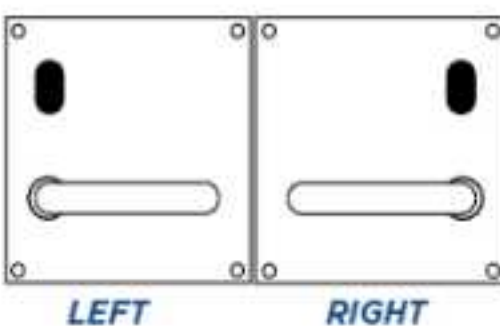
'162 Series' SQ. INTERNAL PLATE

Art ID.	Description
PSQ-01V-25-S-L	CYL HOLE & LEVER - LEFT
PSQ-01V-25-S-R	CYL HOLE & LEVER - RIGHT

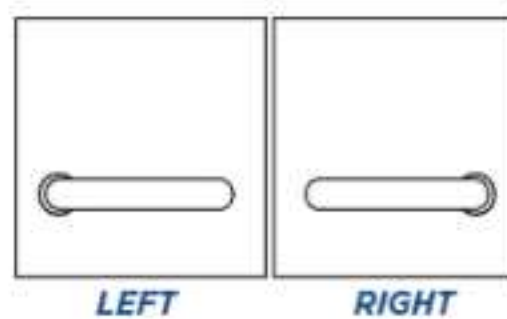

'162 Series' SQ. EXTERNAL PLATE

Art ID.	Description
PSQ-02C-25-S-L	LEVER ONLY - LEFT
PSQ-02C-25-S-R	LEVER ONLY - RIGHT

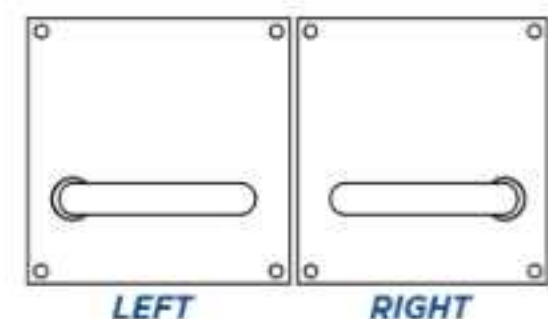

'162 Series' SQ. INTERNAL PLATE

Art ID.	Description
PSQ-02V-25-S-L	LEVER ONLY - LEFT
PSQ-02V-25-S-R	LEVER ONLY - RIGHT

162 Square Plate Furniture

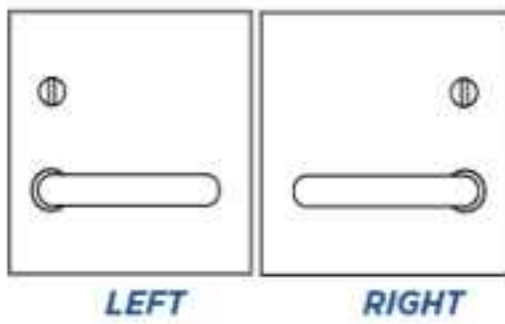

'162 Series' SQ. EXTERNAL PLATE

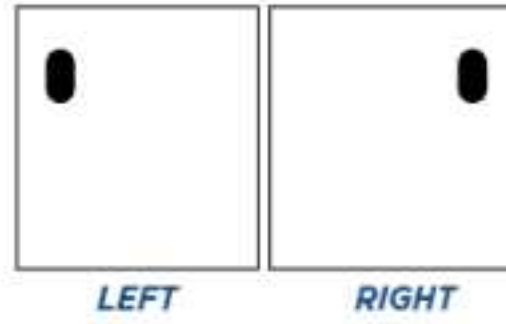

'162 Series' SQ. EXTERNAL PLATE

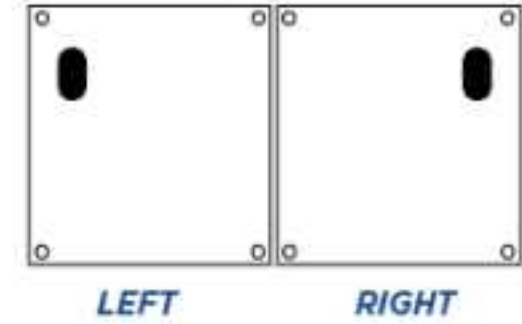

'162 Series' SQ. INTERNAL PLATE

Art ID.	Description
PSQ-03C-25-S-L	EMERGENCY TURN & LEVER - LEFT
PSQ-03C-25-S-R	EMERGENCY TURN & LEVER - RIGHT

Art ID.	Description
PSQ-04C-S-L	CYL HOLE ONLY - LEFT
PSQ-04C-S-R	CYL HOLE ONLY - RIGHT

Art ID.	Description
PSQ-04V-S-L	CYL HOLE ONLY - LEFT
PSQ-04V-S-R	CYL HOLE ONLY - RIGHT

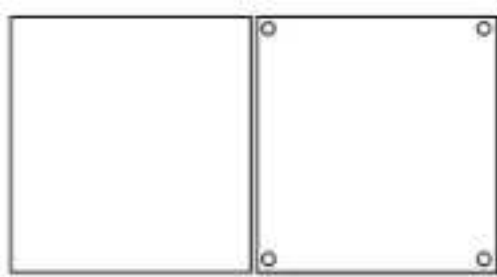

'162 Series' SQ. EXTERNAL & INTERNAL PLATE

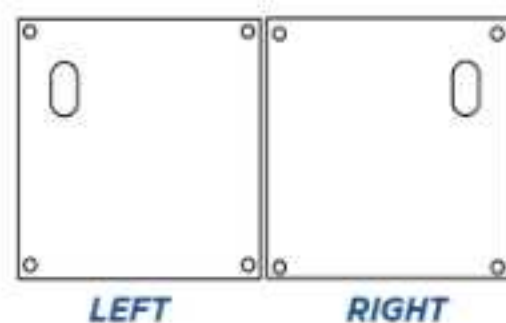

'162 Series' SQ. INTERNAL PLATE

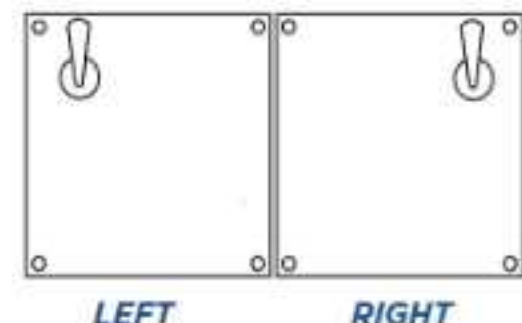

'162 Series' SQ. INTERNAL PLATE

Art ID.	Description
PSQ-05C-S	'EXT' PLAIN PLATE
PSQ-05V-S	'INT' PLAIN PLATE

Art ID.	Description
PSQ-06V-S-L	SNIB ONLY - LEFT
PSQ-06V-S-R	SNIB ONLY - RIGHT

Art ID.	Description
PSQ-06VDA-2-S-L	DA TURN SNIB ONLY - LEFT
PSQ-06VDA-2-S-R	DA TURN SNIB ONLY - RIGHT

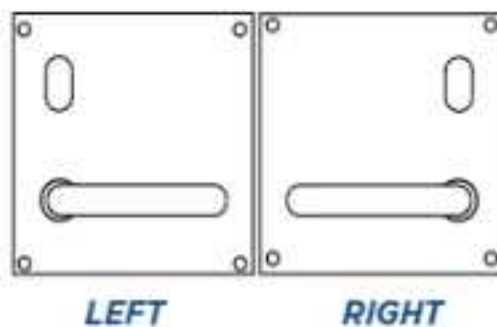

'162 Series' SQ. INTERNAL PLATE

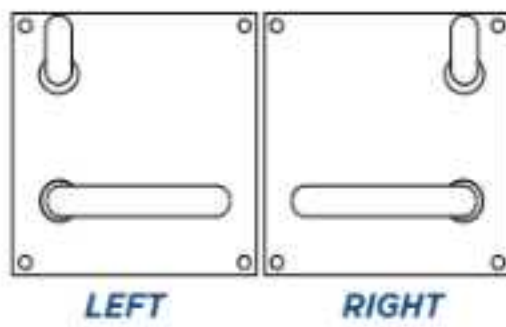

'162 Series' SQ. INTERNAL PLATE

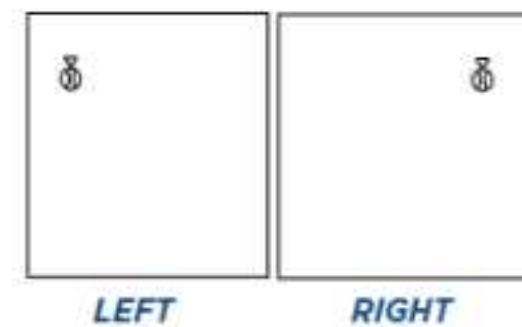

'162 Series' SQ. EXTERNAL PLATE

Art ID.	Description
PSQ-13V-25-S-L	SNIB & LEVER - LEFT
PSQ-13V-25-S-R	SNIB & LEVER - RIGHT

Art ID.	Description
PSQ-13VDA-25-S-L	DA TURN SNIB & LEVER - LEFT
PSQ-13VDA-25-S-R	DA TURN SNIB & LEVER - RIGHT

Art ID.	Description
PSQ-23C-S-L	EMERGENCY TURN & INDICATOR ONLY - LEFT
PSQ-23C-S-R	EMERGENCY TURN & INDICATOR ONLY - RIGHT

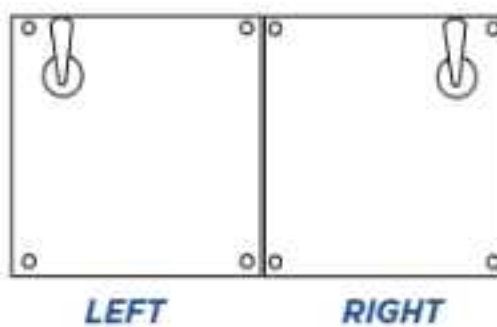

'162 Series' SQ. INTERNAL PLATE

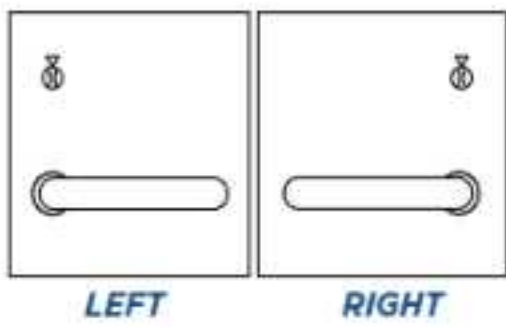

'162 Series' SQ. EXTERNAL PLATE

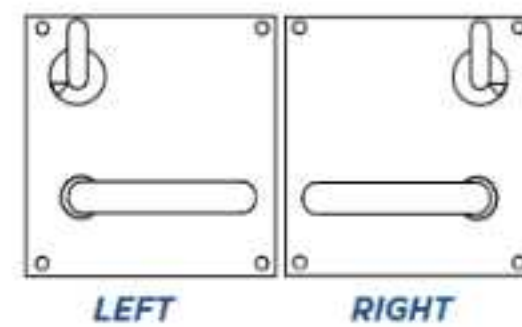

'162 Series' SQ. INTERNAL PLATE

Art ID.	Description
PSQ-23VDA-2-S-L	INDICATING DA TURN SNIB ONLY - LEFT
PSQ-23VDA-2-S-R	INDICATING DA TURN SNIB ONLY - RIGHT

Art ID.	Description
PSQ-53C-25-S-L	EMERGENCY TURN, INDICATOR & LEVER - LEFT
PSQ-53C-25-S-R	EMERGENCY TURN, INDICATOR & LEVER - RIGHT

Art ID.	Description
PSQ-63VDA-25-S-L	INDICATING DA TURN SNIB & LEVER - LEFT
PSQ-63VDA-25-S-R	INDICATING DA TURN SNIB & LEVER - RIGHT



Art ID. SGDC100-S



'100 Series' DOOR CLOSER

- Rack & Pinion (2/3/4)

PRODUCT SPECIFICATION

- Rack & Pinion operation
- Suits Left & Right Handed Doors
- Suits Inward & Outward Opening Doors
- Comes with Standard arm
- Parallel Arm Bracket
- Supplied with both Timber and "Self Tapping" Metal screw packs
- Simple to read installation instructions
- Can be fitted with optional Hold Open Arm
- Closing, Latching Speed & Backcheck Adjustment
- Closing range 180° - 15°
- Latching speed range 15° - 0°
- Suitable for door sizes 2/3/4 by mounting template adjustment
- Size #2: Door width of 850mm & Weight of 40kg
- Size #3: Door width of 950mm & weight of 60kg
- Size #4: Door width of 1100mm & Weight of 80kg
- 10 Year Warranty (*)
- Fire Rated AS1905, AS1530 (2 Hours)
- Tested & certified to BS EN 1154:1997
- MADE IN TAIWAN
- Stock from December 2024 supplied with Backcheck

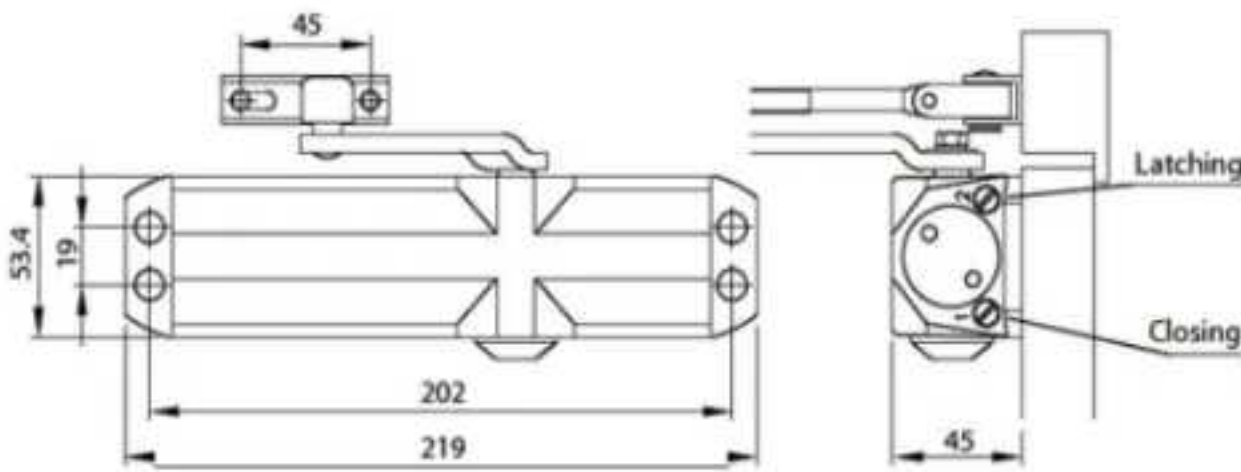

2-Hours

SGDC100 - IN THE BOX:



1 x Door Closer



1 x Rack & Pinion Arm Assembly



1 x Parallel Arm Bracket



1 x End Cap



"Self Tapping" Metal Fixing Screw Pack



Timber Fixing Screw Pack



Arm Fixing/Assembly Screw Pack



Installation Instructions & Fitting Template

Optional Accessories



'100 Series' HOLD OPEN ARM
Art ID. SGDCHOAR



Parallel Arm PACKER
Art ID. SGDCA112



Art ID. SGDC150-S



'150 Series' DOOR CLOSER

- Rack & Pinion (2/3/4)

PRODUCT SPECIFICATION

- Rack & Pinion operation
- Suits Left & Right Opening Doors
- Suits Inward & Outward Opening Doors
- Comes with Standard arm
- Parallel Arm Bracket
- Supplied with both Timber and "Self Tapping" Metal screw packs
- Simple to read installation instructions
- Can be fitted with optional Hold Open Arm
- Closing & Latching Speed Adjustment
- Closing range 180° - 15°
- Latching speed range 15° - 0°
- Suitable for door sizes 2/3/4 by mounting template adjustment
- Size #2: Door width of 850mm & Weight of 40kg
- Size #3: Door width of 950mm & weight of 60kg
- Size #4: Door width of 1100mm & Weight of 80kg
- 10 Year Warranty (*)
- MADE IN TAIWAN

10 YEARS
WARRANTY

CUSTOM ENGRAVING AVAILABLE

COMPLETE DOOR CLOSERS - YOUR LOGO



Art ID. SGDC150-S-ENGR
QTY. 6

FACE PLATES ONLY - YOUR LOGO



Art ID. SGDC150-S-FP-ENGR
QTY. 10

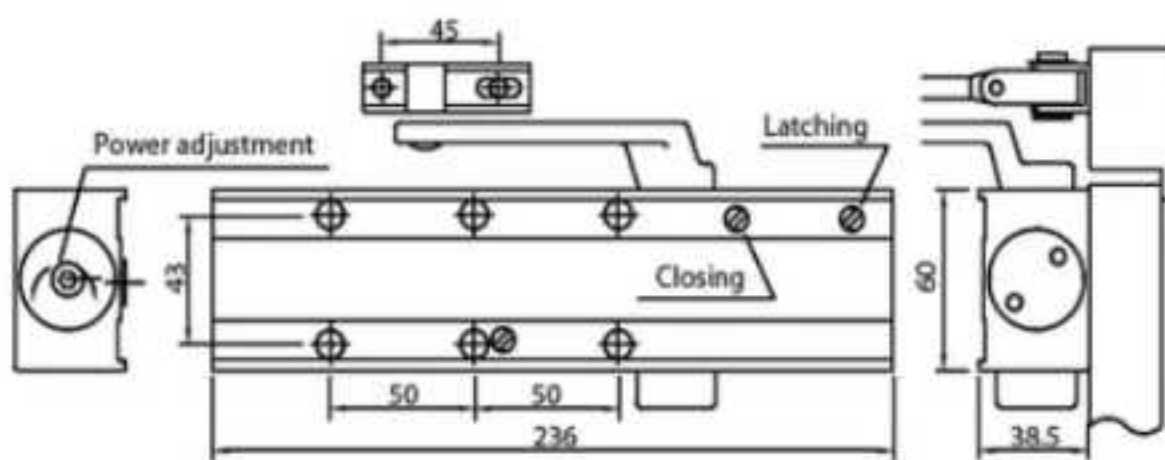

SGDC150 - IN THE BOX:



1 x Door Closer



1 x Rack & Pinion Arm Assembly



1 x Parallel Arm Bracket



1 x End Cap



"Self Tapping" Metal Fixing Screw Pack



Timber Fixing Screw Pack



Arm Fixing/Assembly Screw Pack



Installation Instructions & Fitting Template

Optional Accessories



'150 Series'
HOLD OPEN ARM
Art ID. SGDCHOAR-2



Parallel Arm PACKER
Art ID. SGDCAI12



Art ID. SGDC160-S



'160 Series' DOOR CLOSER

- Rack & Pinion (2/3/4)

PRODUCT SPECIFICATION

- Rack & Pinion operation
- Suits Left & Right Opening Doors
- Suits Inward & Outward Opening Doors
- Comes with Standard arm
- Parallel Arm Bracket
- Supplied with both Timber and "Self Tapping" Metal Screw Packs
- Adjustable Backcheck (opening limit)
- Simple to read installation instructions
- Can be fitted with optional Hold Open Arm or Slide Arm.
- Closing & Latching Speed Adjustment
- Closing range 180° - 15°
- Latching speed range 15° - 0°
- Suitable for door sizes 2-4 adjustable on door with Hex Key
- Size #2: Door width of 850mm & Weight of 40kg
- Size #3: Door width of 950mm & weight of 60kg
- Size #4: Door width of 1100mm & Weight of 80kg
- 10 Year Warranty (*)
- Fire Rated AS1905, AS1530 (4 Hours)
- Tested & certified to BS EN 1154:1997
- MADE IN TAIWAN



Art ID. SGDC160-BLK



4-Hours



(500,000 Cycles)

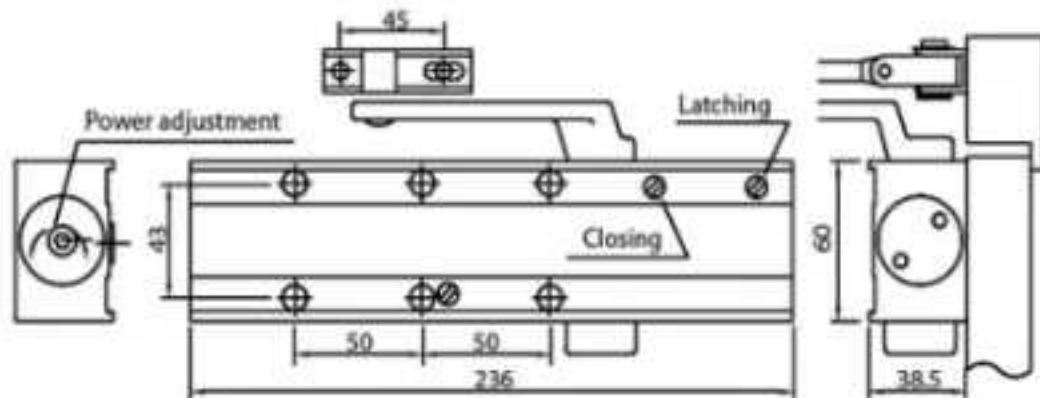

CUSTOM ENGRAVING AVAILABLE

COMPLETE DOOR CLOSERS - YOUR LOGO



Art ID. SGDC160-S-ENGR

Qty. 6



Art ID. SGDC160-BLK-ENGR

Qty. 6

FACE PLATES ONLY - YOUR LOGO



Art ID. SGDC160-S-FP-ENGR

Qty. 10

FROM



Art ID. SGDC160-BLK-FP-ENGR

Qty. 10

FROM

SGDC160 - IN THE BOX:



1x Door Closer



1x Rack & Pinion Arm Assembly



1x Parallel Arm Bracket



1x End Cap



1x 5mm Allen Key



"Self Tapping" Metal Fixing Screw Pack



Timber Fixing Screw Pack



Arm Fixing/Assembly Screw Pack



Installation Instructions & Fitting Template

Optional Accessories



HOLD OPEN ARM
Art ID. SGDCHOAR-2



SLIDING TRACK ARM (Slide Rail)
Art ID. SGDCAO78



Parallel Arm PACKER
Art ID. SGDCAI12



MOUNTING PLATE
Art ID. SGDC160-MP

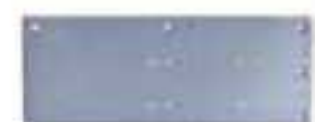

DROP PLATE
Art ID. SGDCAO60



'165 Series' DOOR CLOSER

- Rack & Pinion (2/3/4/5/6)



Art ID. SGDC165-BLK



Art ID. SGDC165-S



PRODUCT SPECIFICATION

- Rack & Pinion operation
- Suits Left & Right Opening Doors
- Suits Inward & Outward Opening Doors
- Delayed action function between 180° - 65°
- Comes with Standard arm
- Parallel Arm Bracket
- Supplied with both Timber and "Self Tapping" Metal Screw Packs
- Adjustable Backcheck (opening limit)
- Simple to read installation instructions
- Can be fitted with optional Hold Open Arm or Slide Arm.
- Closing & Latching Speed Adjustment
- Closing range 180° - 15°
- Latching speed range 15° - 0°
- Suitable for door sizes 2-6 adjustable on door with Hex Key
- Size #2: Door width of 850mm & Weight of 40kg
- Size #3: Door width of 950mm & weight of 60kg
- Size #4: Door width of 1100mm & Weight of 80kg
- Size #5: Door width of 1250mm & Weight of 100kg
- Size #6: Door width of 1400mm & Weight of 120kg
- 10 Year Warranty (*)
- Fire Rated AS1905, As1530
- Tested & certified to BS EN 1154:1997
- MADE IN TAIWAN

10 YEARS WARRANTY



2-Hours



(500,000 Cycles)

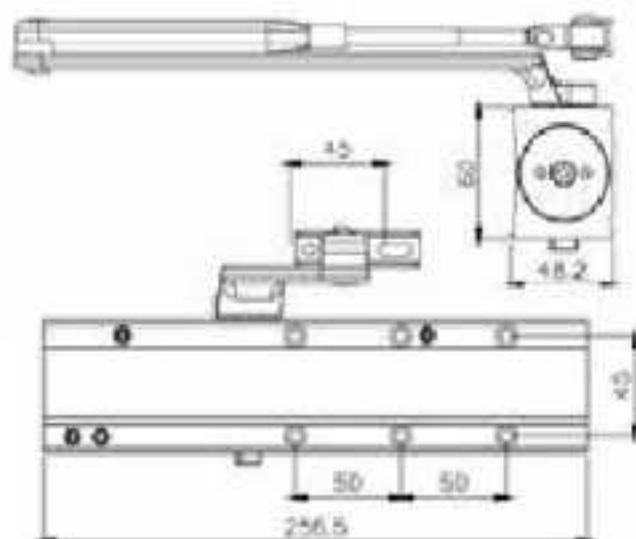

CUSTOM ENGRAVING AVAILABLE

COMPLETE DOOR CLOSERS - YOUR LOGO

FACE PLATES ONLY - YOUR LOGO



Art ID. SGDC165-S-ENGR

QTY. 6



Art ID. SGDC165-BLK-ENGR

QTY. 6



Art ID. SGDC165/195-S-FP-ENGR

QTY. 10

FROM



Art ID. SGDC165/195-BLK-FP-ENGR

QTY. 10

FROM

SGDC165 - IN THE BOX:



1 x Door Closer



1 x Rack & Pinion Arm Assembly



1 x Parallel Arm Bracket



1 x End Cap

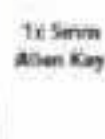

1x 5mm Allen Key



"Self Tapping" Metal Fixing Screw Pack

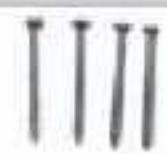

Timber Fixing Screw Pack



Arm Fixing/Assembly Screw Pack



Installation Instructions & Fitting Template

Optional Accessories



HOLD OPEN ARM
Art ID. SGDCHOAR-3



SLIDING TRACK ARM (Slide Rail)
Art ID. SGDCA079



Parallel Arm PACKER
Art ID. SGDCA112



MOUNTING PLATE
Art ID. SGDC165-MP



DROP PLATE
Art ID. SGDCA060



'190 Series' DOOR CLOSER

- Cam Action (1/2/3/4)

10 YEARS WARRANTY

 2-Hours

 (500,000 Cycles)

 DDA

PRODUCT SPECIFICATION

- Cam Action
- Suits Left & Right Opening Doors
- Effortless Opening & Smooth Operation
- Supplied with both Timber and "Self Tapping" Metal Screw Packs
- Adjustable Backcheck (opening limit)
- Simple to read installation instructions
- Can be fitted with optional Hold Open Insert + Slide arm Cushion
- Closing & Latching Speed Adjustment
- Closing range 180° - 15°
- Latching speed range 15° - 0°
- Suitable for door sizes 2-4 adjustable on door with Hex Key
- Size #2: Door width of 850mm & Weight of 40kg
- Size #3: Door width of 950mm & Weight of 60kg
- Size #4: Door width of 1100mm & Weight of 80kg
- 10 Year Warranty (*)
- Fire Rated AS1905, As1530
- Tested & certified to BS EN 1154:1997
- MADE IN TAIWAN



PULL

Art ID. SGDC190-S-B
FROM

PUSH

Art ID. SGDC190-S-G
FROM

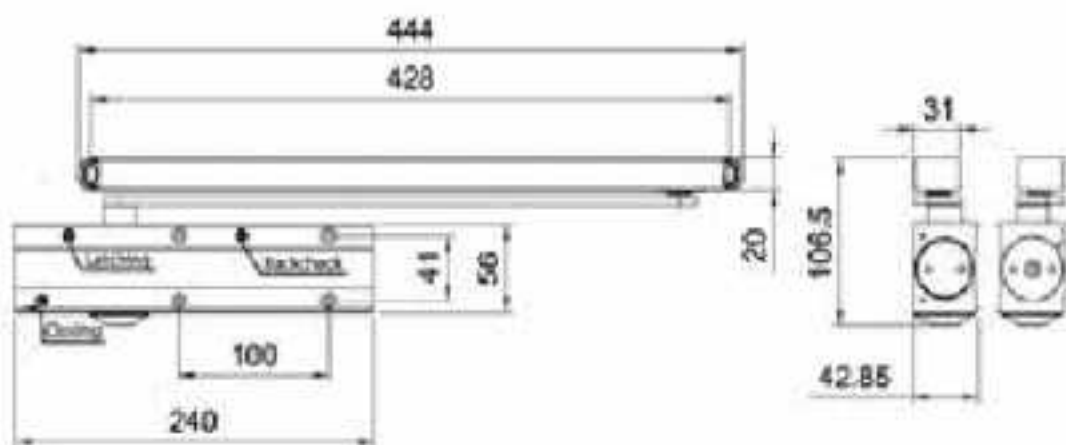

CUSTOM ENGRAVING AVAILABLE

COMPLETE DOOR CLOSERS - YOUR LOGO



PULL
Art ID. SGDC190-S-B-ENGR
QTY. 4



PUSH
Art ID. SGDC190-S-G-ENGR
QTY. 4

FACE PLATES ONLY - YOUR LOGO



Art ID. SGDC190-S-FP-ENGR
QTY. 10

SGDC190-S-B - IN THE BOX:



1 x Door Closer

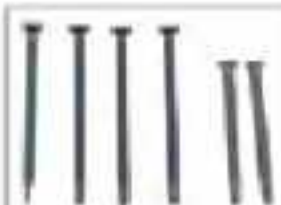

"Self Tapping" Metal Fixing Screw Pack



1 x Slide Arm Channel Assembly



Timber Fixing Screw Pack



1x Allen Key

1x Door Closer End Cap

2x Slide Channel End Caps



Arm Fixing/Assembly Screw Pack



Installation Instructions & Fitting Template

Optional Accessories



SPINDLE COVER
Art ID. SGDC190-S-TC



ANGLE BRACKET
Art ID. SGDC190/195-AB



HOLD OPEN INSERT
Art ID. SGDC190/195-HOU



FIXING PLATE
Art ID. SGDC190/195-FP



SLIDE ARM CUSHION
Art ID. SGDC190/195-CUS



PULL

Art ID. SGDC195-S-B

PUSH

Art ID. SGDC195-S-G



PULL

Art ID. SGDC195-BLK-B

PUSH

Art ID. SGDC195-BLK-G

'195 Series' DOOR CLOSER

- Cam Action (1/2/3/4/5)

PRODUCT SPECIFICATION

- Cam Action
- Suits Left & Right Opening Doors
- Effortless Opening & Smooth Operation
- Supplied with both Timber and "Self Tapping" Metal Screw Packs
- Adjustable Backcheck (opening limit)
- Delayed Action
- Simple to read installation instructions
- Can be fitted with optional Hold Open Insert + Slide arm Cushion
- Closing & Latching Speed Adjustment
- Closing range 180° - 15°
- Latching speed range 15° - 0°
- Suitable for door sizes 2-5
- Size #2: Door width of 850mm & Weight of 40kg
- Size #3: Door width of 950mm & weight of 60kg
- Size #4: Door width of 1100mm & Weight of 80kg
- Size #5: Door width of 1100mm & Weight of 100kg
- 10 Year Warranty (*)
- Fire Rated AS1905, As1530
- Tested & certified to BS EN 1154:1997
- MADE IN TAIWAN

10 YEARS WARRANTY

 2-Hours

 (500,000 Cycles)

 DDA

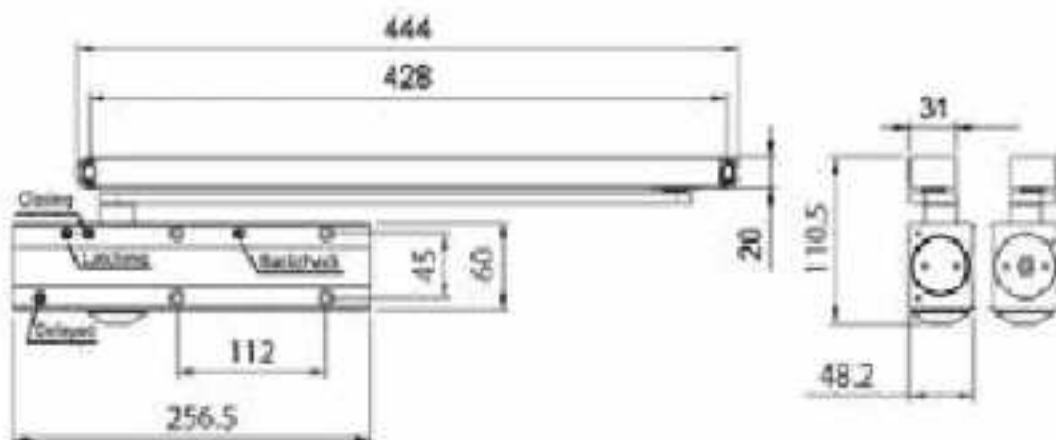

CUSTOM ENGRAVING AVAILABLE

COMPLETE DOOR CLOSERS - YOUR LOGO



PULL Art ID. SGDC195-S-B-ENGR
PUSH Art ID. SGDC195-S-G-ENGR

QTY. 4



PULL Art ID. SGDC195-BLK-B-ENGR
PUSH Art ID. SGDC195-BLK-G-ENGR

QTY. 4

FACE PLATES ONLY - YOUR LOGO



Art ID. SGDC195/195-BLK-FP-ENGR

QTY. 10



Art ID. SGDC195/195-BLK-FP-ENGR

QTY. 10

SGDC195-S-B - IN THE BOX:



1 x Door Closer



1 x Slide Arm Channel Assembly



1 x 6mm Allen Key



1 x Door Closer End Cap



2 x Slide Channel End Caps



"Self Tapping" Metal Fixing Screw Pack

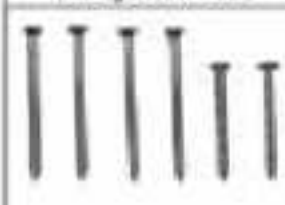

Timber Fixing Screw Pack



Arm Fixing Assembly Screw Pack

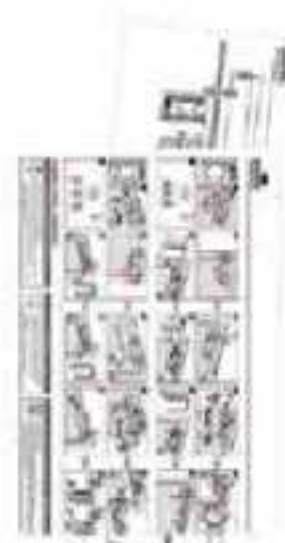

Installation Instructions & Fitting Template

Optional Accessories



SPINDLE COVER
Art ID. SGDC195-S-TC



ANGLE BRACKET
Art ID. SGDC190/195-AB



HOLD OPEN INSERT
Art ID. SGDC190/195-HOU



FIXING PLATE
Art ID. SGDCA095



SLIDE ARM CUSHION
Art ID. SGDC190/195-CUS



FULL RANGE OF PANIC
BARS & ACCESSORIES
SCAN For more



*'Available in rim & vertical
types to suit a wide
variety of applications &
configurations'*

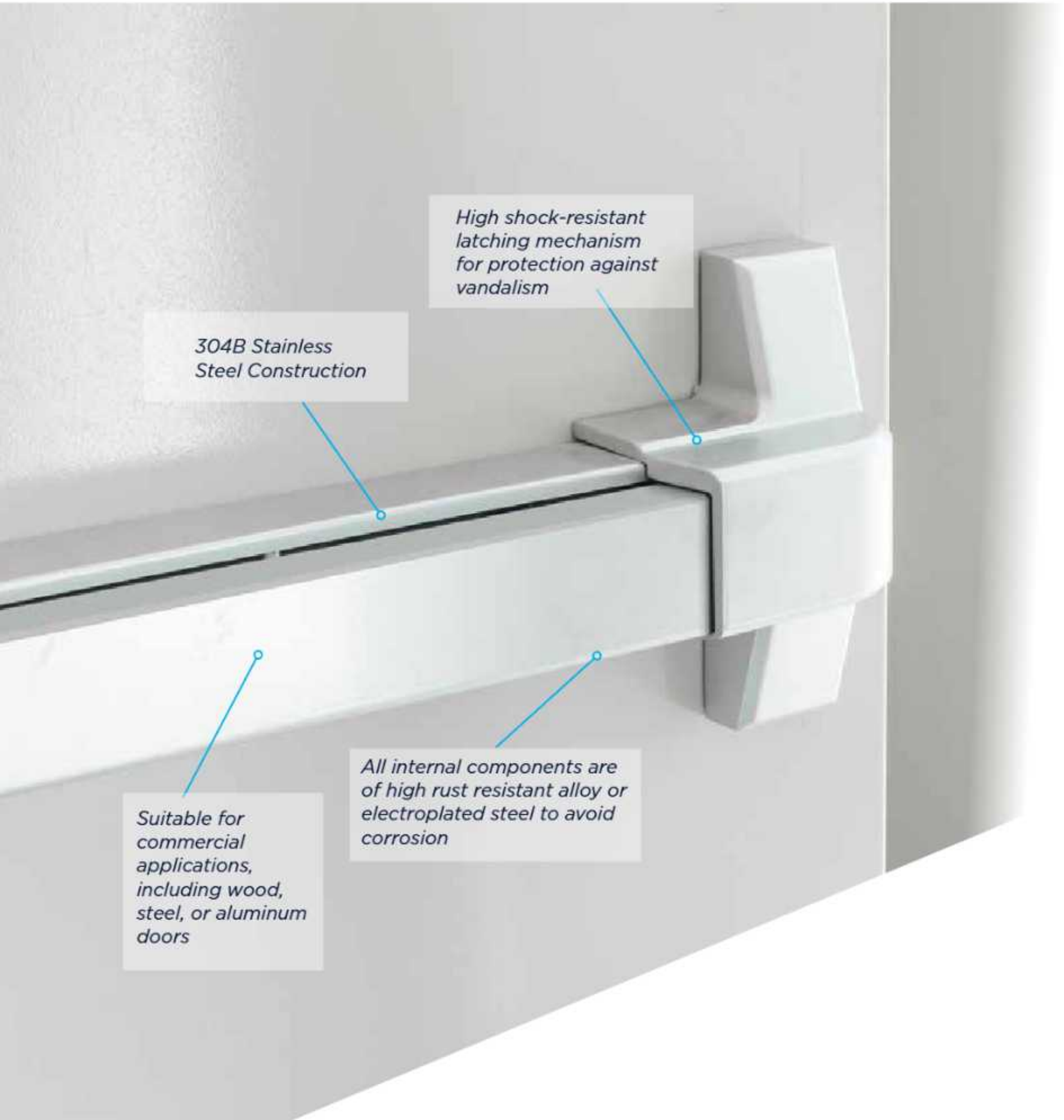

*304B Stainless
Steel Construction*

*High shock-resistant
latching mechanism
for protection against
vandalism*

*Suitable for
commercial
applications,
including wood,
steel, or aluminum
doors*

*All internal components are
of high rust resistant alloy or
electroplated steel to avoid
corrosion*



Panic Exit DOUBLE DOOR KITS 'STANDARD' Door sizes

PRODUCT SPECIFICATION:

- Complies with BS EN1125
- Surface mount installation
- 304B Stainless steel construction
- High Shock resistant latching mechanism
- All inside components are of high rust resistant alloy & heavily electroplated steel to avoid corrosion
- NON Handed
- Alternative external access options available
- Compatible with 201 "Round" Cylinder for exterior access
- Latch automatically dead latches when door is closed
- Single Point Panic Bar - width 820 mm
- Double Point Panic Bar - width 900 mm
- Suits standard door size (820 mm) can be cut down up to 170 mm to suit smaller doors
- Dogging - hold back function with Allen key slot in internal push bar (Non - Fire rated model only)



KIT INCLUDES:

- Single Point Panic Bar
- Double Point Panic Bar
- Overlapping strike

STANDARD DOOR SIZE KITS

Art ID.	Description
SGPD250-DDKIT	Panic Exit DOUBLE DOOR KIT - Standard Door sizes - w/ Hold Back Function - Inc. 2 x Panic Bars & 1 x Overlapping Strike
 SGPD250-F-DDKIT	'FIRE RATED' Panic Exit DOUBLE DOOR KIT - Standard Door Sizes - Inc. 2 x Panic Bars & 1 x O/Lap. Strike

Panic Exit DOUBLE DOOR KITS 'WIDE' Door sizes

PRODUCT SPECIFICATION:

- Complies with BS EN1125
- Surface mount installation
- 304B Stainless steel construction
- High Shock resistant latching mechanism
- All inside components are of high rust resistant alloy & heavily electroplated steel to avoid corrosion
- NON Handed
- Alternative external access options available
- Compatible with 201 "Round" Cylinder for exterior access
- Latch automatically dead latches when door is closed
- Single & Double Point Panic Bar - width 1120 mm
- Suits standard door size (1120 mm) can be cut down up to 170 mm to suit smaller doors
- Dogging - hold back function with Allen key slot in internal push bar (Non - Fire rated model only)



KIT INCLUDES:

- Single Point Panic Bar
- Double Point Panic Bar
- Overlapping strike



WIDE DOOR SIZE KITS

Art ID.	Description
SGPD250-WD-DDKIT	Panic Exit DOUBLE DOOR KIT - Wide Door sizes - w/ Hold Back Function - Inc. 2 x Panic Bars & 1 x Overlapping Strike
 SGPD250-WD-F-DDKIT	'FIRE RATED' Panic Exit DOUBLE DOOR KIT - Wide Door Sizes - Inc. 2 x Panic Bars & 1 x O/Lap. Strike



'6000 Series' Cylindrical LEVERSET 'DDA' Range



- Heavy Duty Cylindrical Leverset
- 70mm Backset Latch
- Fits doors between 35-50mm*
- 85mm Rose Diameter



2-Hour Fire Rating



*Cycle Tested
(400,000 Cycles)*



*Design for Access
and mobility - AS1428.1-2009*



10-Year Warranty



'6000 Series' Cylindrical LEVERSET 'DDA' Range

- Tested to meet Grade 2 (Heavy Duty) specification of 400,000 cycles
- Design for Access and mobility: This product complies with the Disability Access requirements of AS1428.1-2009 (DDA)
- 70mm Backset, Cylindrical Latch
- C4 PD Cylinder
- 2 x Keys Per Lockset
- Accepts most restricted key systems
- Door thickness - 35mm to 45mm
- Ext. to Doors 46-50mm with Art. CL6-4650 *
- Door Prep - 54mm diameter cross bore
- Assembly Screw Size: M8 x 40mm
- Rose Diameter: 85mm
- Standard "T" Strike
- Cylinder Profile: C4 (LW5)
- 10 Year Warranty



Art Id.	Description
EU6000	ENTRANCE (85mm Rose / 70mm BSet) *Satin Chrome*
EU6000-BLK	ENTRANCE (85mm Rose / 70mm BSet) *Matte Black*
EU6011	DOUBLE CYLINDER SET (85mm Rose / 70mm BSet) *Satin Chrome*
EU6011-BLK	DOUBLE CYLINDER SET (85mm Rose / 70mm BSet) *Matte Black*
EU6012	CLASSROOM (85mm Rose / 70mm BSet) *Satin Chrome*
EU6012-BLK	CLASSROOM (85mm Rose / 70mm BSet) *Matte Black*
EU6030	PRIVACY (85mm Rose / 70mm BSet) *Satin Chrome*
EU6030-BLK	PRIVACY (85mm Rose / 70mm BSet) *Matte Black*
EU6052	LATCHING HALF SET (85mm Rose / 70mm BSet) *Satin Chrome*
EU6052-BLK	LATCHING HALF SET (85mm Rose / 70mm BSet) *Matte Black*
EU6061	INSTITUTION SET (85mm Rose / 70mm BSet) *Satin Chrome*
EU6061-BLK	INSTITUTION SET (85mm Rose / 70mm BSet) *Matte Black*
EU6062	STOREROOM (85mm Rose / 70mm BSet) *Satin Chrome*
EU6062-BLK	STOREROOM (85mm Rose / 70mm BSet) *Matte Black*
EU6079	HALF DUMMY (85mm Rose) *Satin Chrome*
EU6079-BLK	HALF DUMMY (85mm Rose) *Matte Black*
EU6082	PASSAGE (85mm Rose / 70mm BSet) *Satin Chrome*
EU6082-BLK	PASSAGE (85mm Rose / 70mm BSet) *Matte Black*



'6000 Series' Cylindrical **CLUTCHING** LEVERSET 'DDA' Range



- Heavy Duty Cylindrical Leverset
- 70mm Backset Latch
- Fits doors between 35-50mm*
- 85mm Rose Diameter



2-Hour Fire Rating



*Cycle Tested
(400,000 Cycles)*



*Design for Access
and mobility - AS1428.1-2009*



10-Year Warranty



'6000 Series' Cylindrical **CLUTCHING** 'DDA' Range



- Tested to meet Grade 2 (Heavy Duty) specification of 400,000 cycles
- Designed for Access and mobility: This product complies with the Disability Access requirements of AS1428.1-2009 (DDA)
- 70mm Backset, Cylindrical Latch
- C4 PD Cylinder
- 2 x Keys Per Lockset
- Accepts most restricted key systems
- Door thickness - 35mm to 45mm
- Ext. to Doors 46-50mm with Art. CL6-4650 *
- Door Prep - 54mm diameter cross bore
- Assembly Screw Size: M8 x 40mm
- Rose Diameter: 85mm
- Standard "T" Strike'
- Cylinder Profile: C4 (LW5)
- 10 Year Warranty



Art Id.	Description
EU6000CL	ENTRANCE *Clutching* (85mm Rose / 70mm BSet) *Satin Chrome*
EU6000CL-BLK	ENTRANCE *Clutching* (85mm Rose / 70mm BSet) *Matte Black*
EU6012CL	CLASSROOM *Clutching* (85mm Rose / 70mm BSet) *Satin Chrome*
EU6012CL-BLK	CLASSROOM *Clutching* (85mm Rose / 70mm BSet) *Matte Black*
EU6062CL	STOREROOM *Clutching* (85mm Rose / 70mm BSet) *Satin Chrome*
EU6062CL-BLK	STOREROOM *Clutching* (85mm Rose / 70mm BSet) *Matte Black*



'6000 Series' COMBO SET Range



- Heavy Duty Cylindrical Knob & Leverset
- 70mm Backset Latch
- Fits doors between 35-50mm*
- 85mm Rose Diameter



2-Hour Fire Rating



*Cycle Tested
(400,000 Cycles)*



10-Year Warranty



'6000 Series' COMBO SETS (KNOB & LEVER)



- Tested to meet Grade 2 (Heavy Duty) specification of 400,000 cycles
- 70mm Backset, Cylindrical Latch
- C4 PD Cylinder
- 2 x Keys Per Lockset
- Accepts most restricted key systems
- Door thickness - 35mm to 45mm
- Ext. to Doors 46-50mm with Art. CL6-4650 *
- Door Prep - 54mm diameter cross bore
- Assembly Screw Size: M8 x 40mm
- Rose Diameter: 85mm
- Standard "T" Strike
- Cylinder Profile: C4 (LW5)
- 10 Year Warranty



Art Id.	Description
EL6000	ENTRANCE (85mm Rose / 70mm BSet) *Satin Chrome*
EL6000-BLK	ENTRANCE (85mm Rose / 70mm BSet) *Matte Black*
EL6012	CLASSROOM (85mm Rose / 70mm BSet) *Satin Chrome*
EL6012-BLK	CLASSROOM (85mm Rose / 70mm BSet) *Matte Black*
EL6062	STOREROOM (85mm Rose / 70mm BSet) *Satin Chrome*
EL6062-BLK	STOREROOM (85mm Rose / 70mm BSet) *Matte Black*



'3000 Series' Cylindrical KNOBSET Range



- Heavy Duty Cylindrical Knobset
- 60 or 70mm Backset Latch
- Fits doors between 35-51mm
- 75mm Rose diameter



2-Hour Fire Rating



*Cycle Tested
(400,000 Cycles)*



10-Year Warranty



'3000 Series' Cylindrical KNOBSET Range



- Tested to meet Grade 2 (Heavy Duty) specification of 400,000 cycles
- 60 or 70mm Backset, Cylindrical Latch
- C4 PD Cylinder
- 2 x Keys Per Lockset
- Accepts most restricted key systems
- Door thickness - 35mm to 51mm
- Door Prep - 54mm diameter cross bore
- Assembly Screw Size: M8 x 40mm
- Rose Diameter: 75mm
- Standard "T" Strike
- Cylinder Profile: C4 (LW5)
- 10 Year Warranty



Art Id.	Description
EA3000	ENTRANCE (70mm) *Satin Stainless Steel*
EA3000-BLK	ENTRANCE (70mm) *Matte Black*
EA3000-60	ENTRANCE (60mm) *Satin Stainless Steel*
EA3000-60-BLK	ENTRANCE (60mm) *Matte Black*
EA3011	DOUBLE CYLINDER SET (70mm) *Satin Stainless Steel*
EA3011-BLK	DOUBLE CYLINDER SET (70mm) *Matte Black*
EA3012	CLASSROOM (70mm) *Satin Stainless Steel*
EA3012-BLK	CLASSROOM (70mm) *Matte Black*
EA3030	PRIVACY (70mm) *Satin Stainless Steel*
EA3030-BLK	PRIVACY (70mm) *Matte Black*
EA3052	LATCHING HALF SET (70mm) *Satin Stainless Steel*
EA3052-BLK	LATCHING HALF SET (70mm) *Matte Black*
EA3061	INSTITUTION SET (70mm) *Satin Stainless Steel*
EA3061-BLK	INSTITUTION SET (70mm) *Matte Black*
EA3062	STOREROOM (70mm) *Satin Stainless Steel*
EA3062-60	STOREROOM (60mm) *Satin Stainless Steel*
EA3062-60-BLK	STOREROOM (60mm) *Matte Black*
EA3062-BLK	STOREROOM (70mm) *Matte Black*
EA3075	HALF DUMMY *Satin Stainless Steel*
EA3075-BLK	HALF DUMMY *Matte Black*
EA3082	PASSAGE (70mm) *Satin Stainless Steel*
EA3082-BLK	PASSAGE (70mm) *Matte Black*

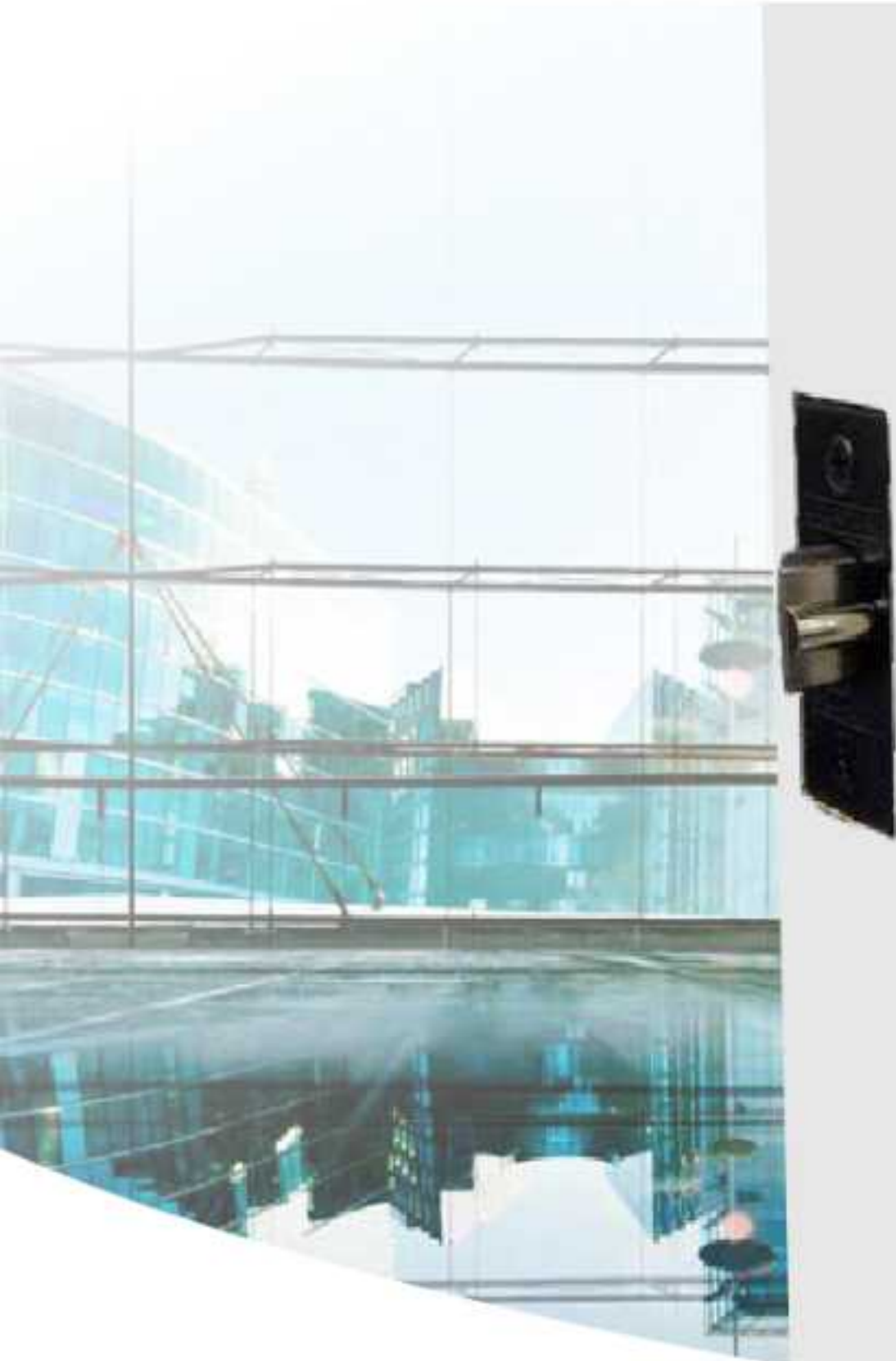

'3000 Series' Tiebolt KNOBSET Range



- Heavy Duty Tiebolt Knobset
- 60 / 70mm Backset Latch
- Fits doors between 35-51mm
- 75mm Rose diameter



*Cycle Tested
(400,000 Cycles)*



10-Year Warranty

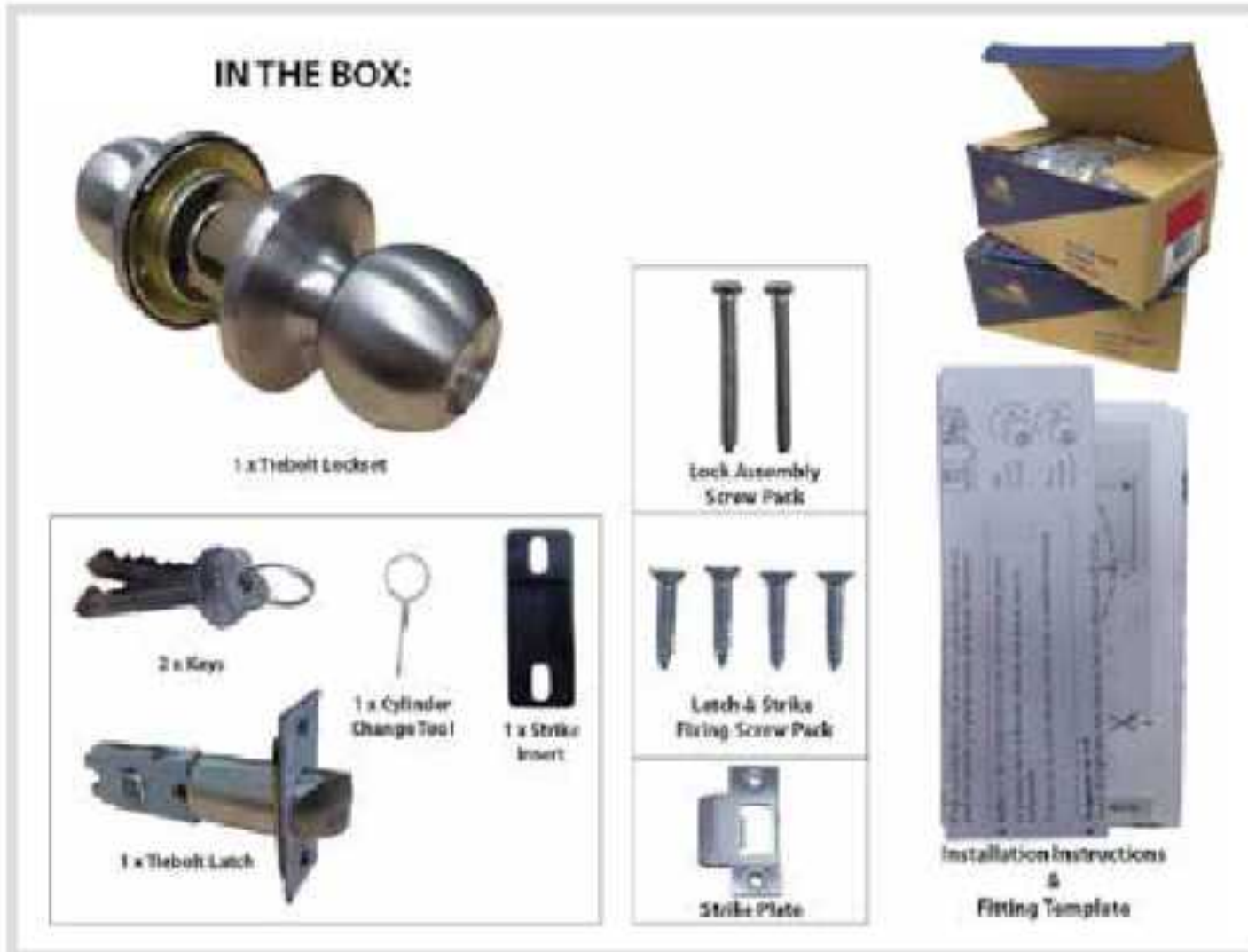

'3000 Series' Tiebolt KNOBSET Range

- Tested to meet Commercial Specifications
- Adjustable 60 /70mm Backset, Tiebolt Latch
- 1 x 6 pin C4 PD Cylinder
- 2 x Keys Per Lockset
- Accepts most restricted key systems
- Door thickness - 35mm to 51mm
- Door Prep - 54mm diameter cross bore
- Assembly Screw Size: M8 x 40mm
- Rose Diameter: 75mm
- Standard "T" Strike'
- Cylinder Profile: C4 (LW5)
- 10 Year Warranty



Art Id.	Description
TA3000	ENTRANCE (75mm Rose / 60-70mm BSet) *Satin Stainless Steel*
TA3011	DOUBLE CYLINDER SET (75mm Rose / 60-70mm BSet) *Satin Stainless Steel*
TA3012	CLASSROOM (75mm Rose / 60-70mm BSet) *Satin Stainless Steel*
TA3030	PRIVACY (75mm Rose / 60-70mm BSet) *Satin Stainless Steel*
TA3052	LATCHING HALF SET (75mm Rose / 60-70mm BSet) *Satin Stainless Steel*
TA3062	STOREROOM (75mm Rose / 60-70mm BSet) *Satin Stainless Steel*
TA3082	PASSAGE (75mm Rose / 60-70mm BSet) *Satin Stainless Steel*
TA3000-BLK	ENTRANCE (75mm Rose / 60-70mm BSet) *Matte Black*
TA3011-BLK	DOUBLE CYLINDER SET (75mm Rose / 60-70mm BSet) *Matte Black*
TA3012-BLK	CLASSROOM (75mm Rose / 60-70mm BSet) *Matte Black*
TA3030-BLK	PRIVACY (75mm Rose / 60-70mm BSet) *Matte Black*
TA3052-BLK	LATCHING HALF SET (75mm Rose / 60-70mm BSet) *Matte Black*
TA3062-BLK	STOREROOM (75mm Rose / 60-70mm BSet) *Matte Black*
TA3082-BLK	PASSAGE (75mm Rose / 60-70mm BSet) *Matte Black*



'4000 Series' DEADBOLT Range



- Heavy Duty Deadbolt
- 60 / 70mm Adj. Backset Latch
- Fits doors between 35-45mm

 *Cycle Tested
(400,000 Cycles)*

 *10-Year Warranty*



'4000 Series' DEADBOLT Range

- Grade 2 (Heavy Duty) specification, Tested to 400,000 cycles
- 25mm Throw bolt with saw resistant hardened steel roller pin
- Suits door thickness 35mm - 45mm (up to 50mm without roses)
- Adjustable 60mm-70mm backset
- C4 PD cylinder
- 2 x keys per lock
- Suitable for restricted key systems
- Cylinder Profile: C4 (LW5)
- 10 Year Warranty



Art Id.	Description
SGDB4010	'4000 Series' DEADBOLT - Single Cylinder (60-70mm BSet) *Satin Stainless Steel*
SGDB4010-BLK	'4000 Series' DEADBOLT - Single Cylinder (60-70mm BSet) *Matte Black*
SGDB4011	'4000 Series' DEADBOLT - Double Cylinder (60-70mm BSet) *Satin Stainless Steel*
SGDB4011-BLK	'4000 Series' DEADBOLT - Double Cylinder (60-70mm BSet) *Matte Black*

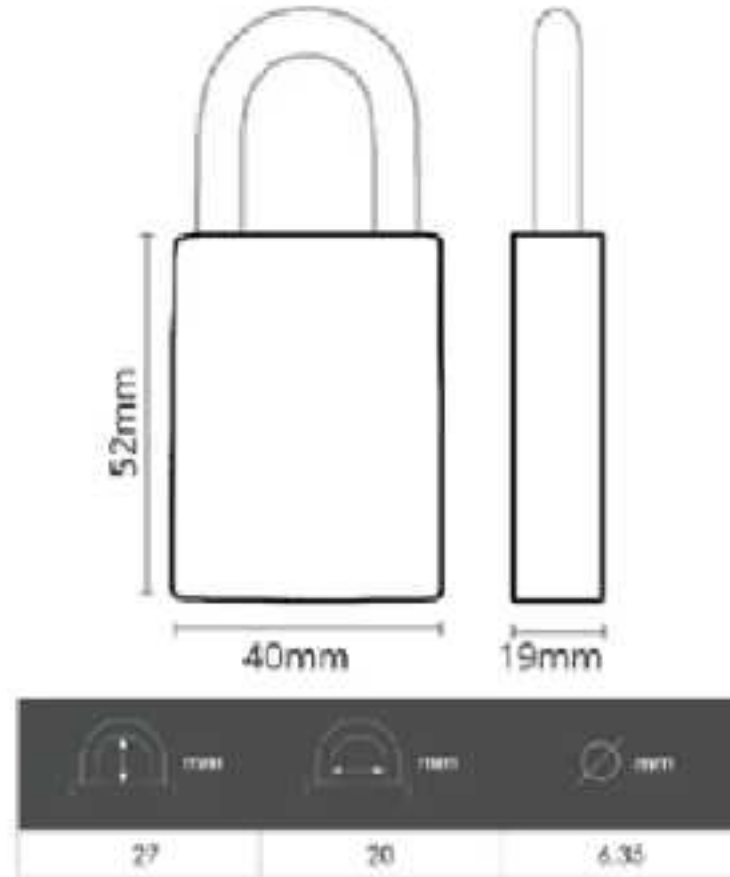

500 Series' 40mm PADLOCK - S/STEEL SHKL.

PRODUCT SPECIFICATION

- Body Material: Solid Brass
- Body Width: 40mm
- Cylinder Profile: C4 (LW5)
- Quick Change Shackle
- Shackle Clearance: 27mm (Fitted as Standard, longer shackle options are available)
- Shackle Material: Stainless Steel
- Shackle Thickness: 6.35mm
- Key Release Function: Yes (Snapshut as Standard)
- Key Retain Function: Yes (By fitting LOCKTON 'L' Bar, supplied w/ Padlock)
- 10 Year Warranty



Description	Art ID
KA1 - Keyed Alike Group 1	500/40-KA1
KA2 - Keyed Alike Group 2	500/40-KA2
KD - Keyed to Differ	500/40-KD

Available Configurations



Description	Art ID
ALB - All Less Barrel	500/40-ALB



Description	Art ID
LBS - Less Barrel, Less Shackle	500/40-LBS



Description	Art ID
ALB - Engraved (Box of 10)	500/40-ALB-ENGR
KA1 - Engraved (Box of 10)	500/40-KA1-ENGR
KA2 - Engraved (Box of 10)	500/40-KA2-ENGR
KD - Engraved (Box of 10)	500/40-KD-ENGR
LBS - Engraved (Box of 10)	500/40-LBS-ENGR



40mm Padlock Accessories

Available in:
27mm
50mm
75mm



500 Series' Spare SHACKLES

PRODUCT DESCRIPTION

LOCKTON 500 Series Shackles, are replacement shackles to suit the LOCKTON range of 40mm Padlocks. Made easier to change due to the "Quick change shackle design".

Shackle Clearance	Art ID.	Shackle Diameter
27 mm	500/40.27-SS	6.35mm
50 mm	500/40.50-SS	6.35mm
75 mm	500/40.75-SS	6.35mm



Art ID. 500/40.COL

500 Series' SHACKLE COLLAR - Suits 40mm Padlock

PRODUCT DESCRIPTION

This collar is designed to fit onto shackles that fit the LOCKTON 500 Series 40mm Padlock Range (see RELATED PRODUCTS).

The collar is used to retain one end of a chain to assist in securing large gates and entry ways.

The design and size of the collar ensures that it will not pass over the radius of the shackle which keeps the chain secure.

PRODUCT SPECIFICATION

- Material: Stainless Steel
- Suits Shackle Diameter: 6.35mm



Art ID. 500-40.LAN

500 Series' SHACKLE LANYARD (S/Steel + Wire Rope)

PRODUCT DESCRIPTION

The LOCKTON 500/40.LAN Padlock Shackle Lanyard is designed to suit 6.35mm Diameter Shackles.

This lanyard is designed to fit onto shackles that fit the LOCKTON 500 Series 40mm Padlock Range.

The lanyard is used to assist in securing gates and entry ways with one end retained to the shackle.

The design and size of the lanyard ensures that it will not pass over the radius of the shackle.

PRODUCT SPECIFICATION

- Material: Stainless Steel
- Shackle End Diameter: 6.45mm (suits 6.35mm Dia. Shackle)
- Long End Diameter: 7.2mm (suits Fixing Screw/Bolt)
- Cable Diameter: 5mm
- Cable Length: 245mm
- Overall Length: 318mm



Available in:



500 Series' ALL-WEATHER COVER

PRODUCT DESCRIPTION

This high quality cover will protect your padlock keyway from intrusive weather and environmental affects like rain, dust and other invasive elements. It's ergonomic design also makes application and installation an easy process.

Colour	Art ID.
Black	500/40.WC-BLK
Blue	500/40.WC-BLU
Green	500/40.WC-GRN
Red	500/40.WC-RED
Yellow	500/40.WC-YEL



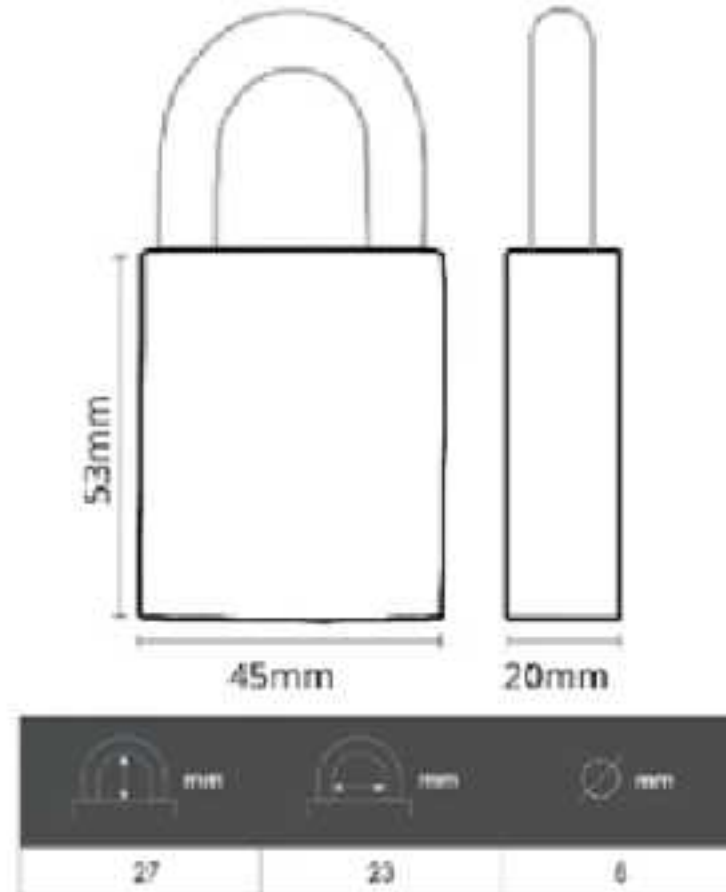

Description	Art ID
KA1 - Keyed Alike Group 1	500/45-KA1
KA2 - Keyed Alike Group 2	500/45-KA2
KA3 - Keyed Alike Group 3	500/45-KA3
KA4 - Keyed Alike Group 4	500/45-KA4
KD - Keyed to Differ	500/40-KD
*SS Shackle KA1 - Keyed Alike Group 1	500/45-SS-KA1

500 Series' 45mm PADLOCK

PRODUCT SPECIFICATION

- Body Material: Solid Brass
- Body Width: 45mm
- Configuration: Keyed Alike - KA1 (Also available in KA2, KA3 & KA4)
- Cylinder Profile: C4 (LW5)
- Quick Change Shackle: Yes
- Shackle Clearance: 27mm (Fitted as Standard, longer shackle options are available)
- Shackle Material: Boron (Also available in S/Steel or Brass)
- Shackle Thickness: 8mm
- Key Release Function: Yes (Snapshot as standard)
- Key Retain Function: Yes (By fitting LOCKTON 'L' Bar, supplied w/ Padlock)



Available Configurations



Description Art ID

ALB - All Less Barrel 500/45-ALB

*SS - ALB - All Less Barrel 500/45-SS-ALB



Description Art ID

LBS - Less Barrel, Less Shackle 500/40-LBS



Description Art ID

ALC - All Less Core 500/45-ALC

*SS - ALC - All Less Core 500/45-SS-ALC



Description	Art ID
ALB - Engraved (Box of 10)	500/45-ALB-ENGR
ALC - Engraved (Box of 10)	500/45-ALC-ENGR
KA1 - Engraved (Box of 10)	500/45-KA1-ENGR
KA2 - Engraved (Box of 10)	500/45-KA2-ENGR
KA3 - Engraved (Box of 10)	500/45-KA3-ENGR
KA4 - Engraved (Box of 10)	500/45-KA4-ENGR
KD - Engraved (Box of 10)	500/45-KD-ENGR
LBS - Engraved (Box of 10)	500/45-LBS-ENGR
*SS - ALB - Engraved (Box of 10)	500/45-SS-ALB-ENGR
*SS - ALC - Engraved (Box of 10)	500/45-SS-ALC-ENGR
*SS - KA1 - Engraved (Box of 10)	500/45-SS-KA1-ENGR

*SS - Stainless Steel Shackle



45mm Padlock Accessories



500 Series' Spare SHACKLES

Shackle Size/ Clearance	Stainless Steel Art ID.	Boron Alloy Art ID.	Brass Art ID.	Shackle Diameter
27 mm	500/45.27-SS	500/45.27	500/45.27-BR	8mm
38 mm	500/45.38-SS	500/45.38	500/45.38-BR	8mm
50 mm	500/45.50-SS	500/45.50	500/45.50-BR	8mm
75 mm	500/45.75-SS	500/45.75	500/45.75-BR	8mm
90 mm	500/45.90-SS	500/45.90	500/45.90-BR	8mm



Art ID. 500/45.COL

500 Series' SHACKLE COLLAR - Suits 45mm Padlock

PRODUCT DESCRIPTION

This collar is designed to fit onto shackles that fit the LOCKTON 500 Series 45mm Padlock Range.

The collar is used to retain one end of a chain to assist in securing large gates and entry ways.

The design and size of the collar ensures that it will not pass over the radius of the shackle which keeps the chain secure.

PRODUCT SPECIFICATION

- Material: Stainless Steel
- Suits Shackle Diameter: 8mm



Art ID. 500-45.LAN

500 Series' SHACKLE LANYARD (S/Steel + Wire Rope)

PRODUCT DESCRIPTION

The LOCKTON 500/45.LAN Padlock Shackle Lanyard is designed to suit 8mm Diameter Shackles.

This lanyard is designed to fit onto shackles that fit the LOCKTON 500 Series 45mm Padlock Range.

The lanyard is used to assist in securing gates and entry ways with one end retained to the shackle.

The design and size of the lanyard ensures that it will not pass over the radius of the shackle.

PRODUCT SPECIFICATION

- Material: Stainless Steel
- Shackle End Diameter: 8.18mm (suits 8mm Dia. Shackle)
- Long End Diameter: 7.15mm (suits Fixing Screw/Bolt)
- Cable Diameter: 5mm
- Cable Length: 245mm
- Overall Length: 318mm



Available in:



500 Series' ALL-WEATHER COVER

PRODUCT DESCRIPTION

This high quality cover will protect your padlock keyway from intrusive weather and environmental affects like rain, dust and other invasive elements. It's ergonomic design also makes application and installation an easy process.

Colour	Art ID.
Black	500/45.WC-BLK
Blue	500/45.WC-BLU
Green	500/45.WC-GRN
Red	500/45.WC-RED
Yellow	500/45.WC-YEL



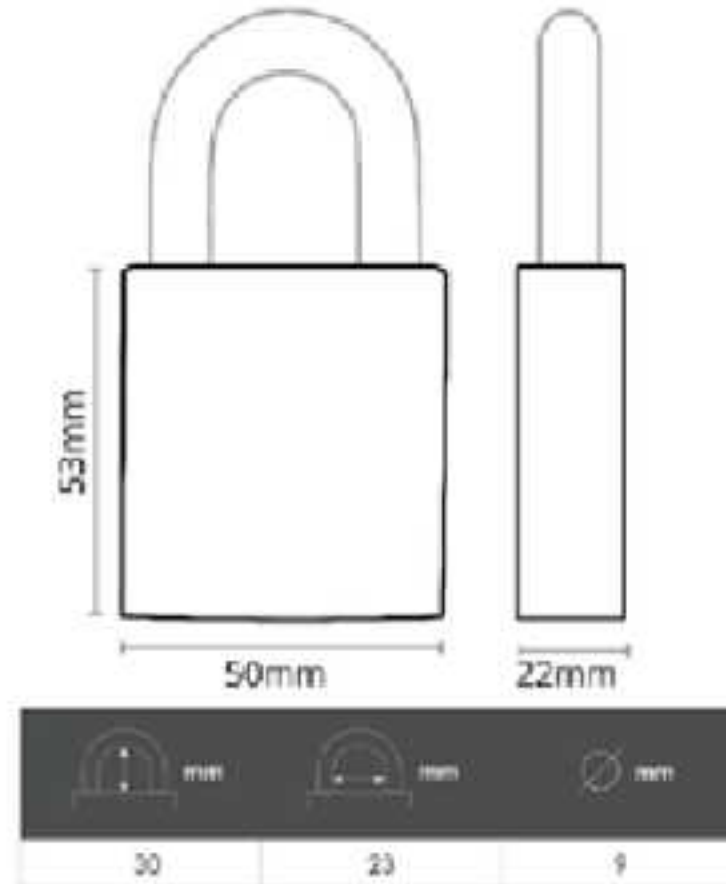

Description	Art ID
KA1 - Keyed Alike Group 1	500/50-KA1
KA2 - Keyed Alike Group 2	500/50-KA2
*SS Shackle KA1 - Keyed Alike Group 1	500/50-SS-KA1

500 Series' 50mm PADLOCK

PRODUCT SPECIFICATION

- Body Material: Nickel Plated Solid Brass
- Body Width: 50mm
- Configuration: Keyed Alike - KA1 (Also available in KA2)
- Cylinder Profile: C4 (LW5)
- Quick Change Shackle: Yes
- Shackle Clearance: 30mm (Fitted as Standard, longer shackle options are available)
- Shackle Material: Boron (Also available in S/Steel or Brass)
- Shackle Thickness: 9mm
- Key Release Function: Yes (Snapshot as standard)
- Key Retain Function: Yes (By fitting LOCKTON 'L' Bar, supplied w/ Padlock)
- 10 Year Warranty (*)



Available Configurations



Description	Art ID
ALB - Engraved (Box of 10)	500/50-ALB-ENGR
ALC - Engraved (Box of 10)	500/50-ALC-ENGR
KA1 - Engraved (Box of 10)	500/50-KA1-ENGR
KA2 - Engraved (Box of 10)	500/50-KA2-ENGR
KD - Engraved (Box of 10)	500/50-KD-ENGR
LBS - Engraved (Box of 10)	500/50-LBS-ENGR
*SS - ALB - Engraved (Box of 10)	500/50-SS-ALB-ENGR
*SS - ALC - Engraved (Box of 10)	500/50-SS-ALC-ENGR
*SS - KA1 - Engraved (Box of 10)	500/50-SS-KA1-ENGR



Description	Art ID
ALB - All Less Barrel	500/50-ALB
*SS - ALB - All Less Barrel	500/50-SS-ALB

Description	Art ID
LBS - Less Barrel, Less Shackle	500/50-LBS

Description	Art ID
ALC - All Less Core	500/50-ALC
*SS - All Less Core	500/50-SS-ALC

*SS - Stainless Steel Shackle



50mm Padlock Accessories

500 Series' Spare SHACKLES



Shackle Size/ Clearance	Stainless Steel Art ID.	Boron Alloy Art ID.	Shackle Diameter
30 mm	500/50.30-SS	500/50.30	9mm
50 mm	500/50.50-SS	500/50.50	9mm
75 mm	500/50.75-SS	500/50.75	9mm
90 mm	500/50.90-SS	500/50.90	9mm



Art ID. 500/50.COL

500 Series' SHACKLE COLLAR - Suits 50mm Padlock

PRODUCT DESCRIPTION

This collar is designed to fit onto shackles that fit the LOCKTON 500 Series 50mm Padlock Range.

The collar is used to retain one end of a chain to assist in securing large gates and entry ways.

The design and size of the collar ensures that it will not pass over the radius of the shackle which keeps the chain secure.

PRODUCT SPECIFICATION

- Material: Stainless Steel
- Suits Shackle Diameter: 9mm



Art ID. 500-50.LAN

500 Series' SHACKLE LANYARD (S/Steel + Wire Rope)

PRODUCT DESCRIPTION

The LOCKTON 500/50.LAN Padlock Shackle Lanyard is designed to suit 9mm Shackles.

This lanyard is designed to fit onto shackles that fit the LOCKTON 500 Series 50mm Padlock Range.

The lanyard is used to assist in securing gates and entry ways with one end retained to the shackle.

The design and size of the lanyard ensures that it will not pass over the radius of the shackle.

PRODUCT SPECIFICATION

- Material: Stainless Steel
- Shackle End Diameter: 9.24mm (suits 9mm Dia. Shackle)
- Long End Diameter: 7.18mm (suits Fixing Screw/Bolt)
- Cable Diameter: 5mm
- Cable Length: 245mm
- Overall Length: 318mm



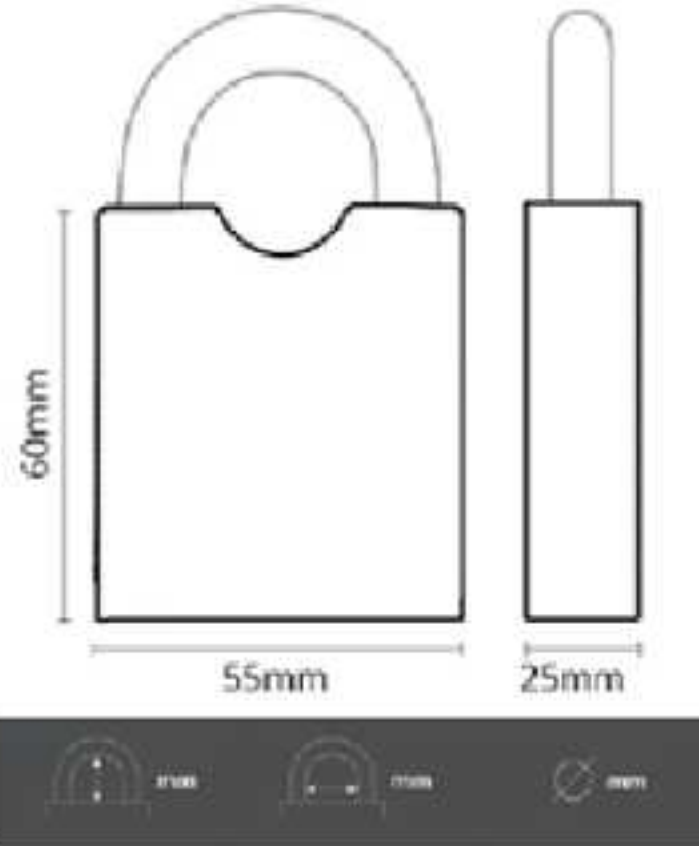

Description	Art ID
KA1 - Keyed Alike Group 1	500/55-KA1
KD - Keyed to Differ	500/55-KD

500 Series' 55mm PADLOCK

PRODUCT SPECIFICATION

- Body Material: Chrome Plated Solid Brass
- Body Width: 55mm
- Configuration: Keyed Alike - KA1
- Cylinder Profile: C4 (LW5)
- Quick Change Shackle: Yes
- Shackle Clearance: 27mm (Fitted as Standard, longer shackle options are available)
- Shackle Material: Boron (Also available in S/Steel or Brass)
- Shackle Thickness: 10mm
- Key Release Function: Yes (Snapshut as standard)
- Key Retain Function: Yes (By fitting LOCKTON 'L' Bar, supplied w/ Padlock)
- 10 Year Warranty (*)



Available Configurations



Description	Art ID
ALB - All Less Barrel	500/55-ALB



Description	Art ID
LBS - Less Barrel, Less Shackle	500/55-LBS



Description	Art ID
ALB - Engraved (Box of 10)	500/50-ALB-ENGR
KA1 - Engraved (Box of 10)	500/50-KA1-ENGR
KD - Engraved (Box of 10)	500/50-KD-ENGR
LBS - Engraved (Box of 10)	500/50-LBS-ENGR



55mm Padlock Accessories

500 Series' Spare SHACKLES

Stainless Steel



Boron Alloy



Shackle Size/ Clearance	Stainless Steel Art ID.	Boron Alloy Art ID.	Shackle Diameter
27 mm	500/55.27-SS	500/55.27	10mm
50 mm	500/55.50-SS	500/55.50	10mm
75 mm	500/55.75-SS	500/55.75	10mm



Art ID. 500/55.COL

500 Series' SHACKLE COLLAR - Suits 55mm Padlock

PRODUCT DESCRIPTION

This collar is designed to fit onto shackles that fit the LOCKTON 500 Series 55mm Padlock Range.

The collar is used to retain one end of a chain to assist in securing large gates and entry ways.

The design and size of the collar ensures that it will not pass over the radius of the shackle which keeps the chain secure.

PRODUCT SPECIFICATION

- Material: Stainless Steel
- Suits Shackle Diameter: 10mm



Art ID. 500-55.LAN

500 Series' SHACKLE LANYARD (S/Steel + Wire Rope)

PRODUCT DESCRIPTION

The LOCKTON 500/55.LAN Padlock Shackle Lanyard is designed to suit 10mm Shackles.

This lanyard is designed to fit onto shackles that fit the LOCKTON 500 Series 55mm Padlock Range.

The lanyard is used to assist in securing gates and entry ways with one end retained to the shackle.

The design and size of the lanyard ensures that it will not pass over the radius of the shackle.

PRODUCT SPECIFICATION

- Material: Stainless Steel
- Shackle End Diameter: 10.3mm (suits 10mm Dia. Shackle)
- Long End Diameter: 7.18mm (suits Fixing Screw/Bolt)
- Cable Diameter: 5mm
- Lanyard Length: 245mm
- Overall Length: 318mm





Aluminium Padlocks

Available Finishes

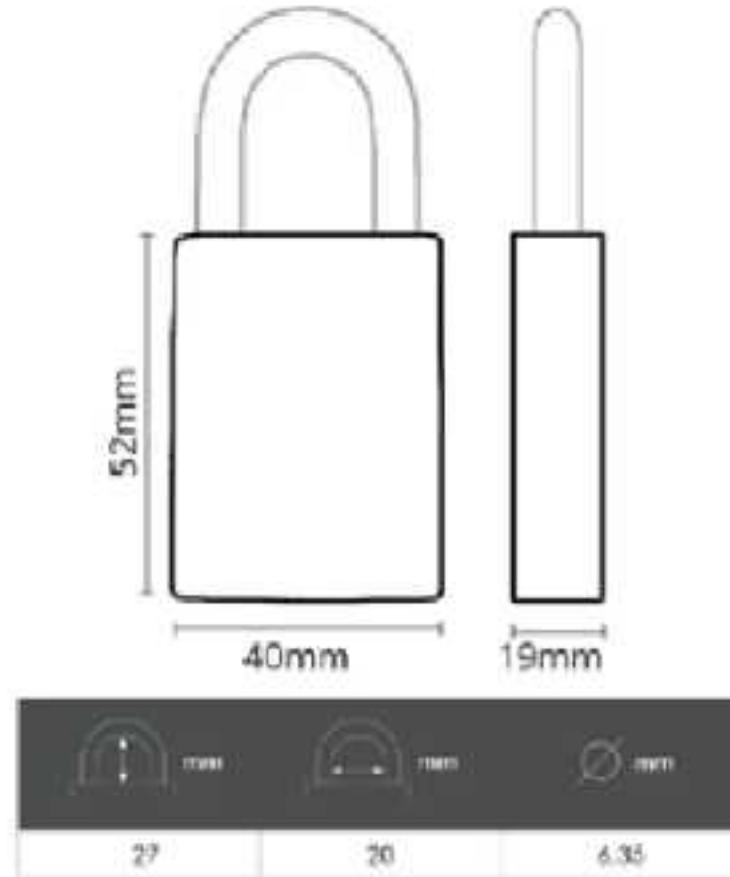

BLUE GREEN



RED ORANGE



PINK BLACK



GUN METAL GREY SILVER

500 Series' 40mm 'AL13' PADLOCK - S/STEEL SHKL.

PRODUCT SPECIFICATION

- Body Material: 6063 Aluminium
- Body Width: 40mm
- Configuration: Keyed to Differ
- Cylinder Profile: C4 (LW5)
- Quick Change Shackle: Yes
- Shackle Clearance: 27mm (Fitted as Standard, longer shackle options are available)
- Shackle Material: Stainless Steel
- Shackle Thickness: 6.35mm
- Key Release Function: Yes (Snapshot as standard)
- Key Retain Function: Yes (By fitting LOCKTON 'L' Bar, supplied w/ Padlock)



6063 ALUMINIUM SPECIFICATIONS

- Body Material: 6063 Aluminium
- High Tensile Strength
 - High Stress Crack Resistance
 - Superior Corrosion Resistance (further increased by anodising)



Available Configurations

(KD) KEYED TO DIFFER - PADLOCK 'AL13' - S/STEEL SHKL.



Art ID	Engraved Art ID.	Finish
500-AL/40-BK-KD	500-AL/40-BK-KD-ENGR	BLACK
500-AL/40-BL-KD	500-AL/40-BL-KD-ENGR	BLUE
500-AL/40-GG-KD	500-AL/40-GG-KD-ENGR	GUN METAL GREY
500-AL/40-GN-KD	500-AL/40-GN-KD-ENGR	GREEN
500-AL/40-OR-KD	500-AL/40-OR-KD-ENGR	ORANGE
500-AL/40-PK-KD	500-AL/40-PK-KD-ENGR	PINK
500-AL/40-RD-KD	500-AL/40-RD-KD-ENGR	RED
500-AL/40-SI-KD	500-AL/40-SI-KD-ENGR	SILVER



(ALB) ALL LESS BARREL - PADLOCK 'AL13' - S/STEEL SHKL.



Art ID	Engraved Art ID.	Finish
500-AL/40-BK-ALB	500-AL/40-BK-ALB-ENGR	BLACK
500-AL/40-BL-ALB	500-AL/40-BL-ALB-ENGR	BLUE
500-AL/40-GG-ALB	500-AL/40-GG-ALB-ENGR	GUN METAL GREY
500-AL/40-GN-ALB	500-AL/40-GN-ALB-ENGR	GREEN
500-AL/40-OR-ALB	500-AL/40-OR-ALB-ENGR	ORANGE
500-AL/40-PK-ALB	500-AL/40-PK-ALB-ENGR	PINK
500-AL/40-RD-ALB	500-AL/40-RD-ALB-ENGR	RED
500-AL/40-SI-ALB	500-AL/40-SI-ALB-ENGR	SILVER



(KD) KEYED TO DIFFER - PADLOCK HANG PACK 'AL13' - S/STEEL SHKL.



Art ID	Engraved Art ID.	Finish
500-AL/40-BK-KD-HP	500-AL/40-BK-KD-HP-ENGR	BLACK
500-AL/40-GG-KD-HP	500-AL/40-GG-KD-HP-ENGR	GUN METAL GREY
500-AL/40-SI-KD-HP	500-AL/40-SI-KD-HP-ENGR	SILVER





AL¹³ Aluminium Padlocks

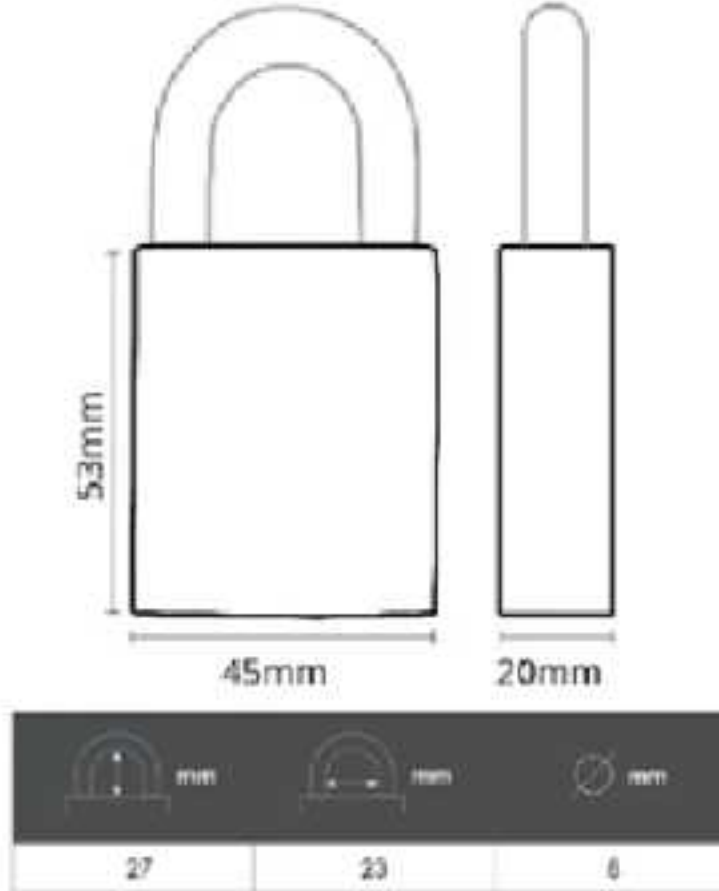

Available Finishes



500 Series' 45mm 'AL13' PADLOCK - S/STEEL SHKL.

PRODUCT SPECIFICATION

- Body Material: 6063 Aluminium
- Body Width: 45mm
- Cylinder Profile: C4 (LW5)
- Quick Change Shackle: Yes
- Shackle Clearance: 27mm (Fitted as Standard, longer shackle options are available)
- Shackle Material: Stainless Steel
- Shackle Thickness: 8mm
- Key Release Function: Yes (Snapshot as standard)
- Key Retain Function: Yes (By fitting LOCKTON 'L' Bar, supplied w/ Padlock)
- 10 Year Warranty (*)



6063 ALUMINIUM SPECIFICATIONS

- Body Material: 6063 Aluminium
- High Tensile Strength
 - High Stress Crack Resistance
 - Superior Corrosion Resistance (further increased by anodising)



Available Configurations

(KD) KEYED TO DIFFER - PADLOCK 'AL13' - S/STEEL SHKL.



Art ID	Engraved Art ID.	Finish
500-AL/45-BK-KD	500-AL/45-BK-KD-ENGR	BLACK
500-AL/45-BL-KD	500-AL/45-BL-KD-ENGR	BLUE
500-AL/45-GG-KD	500-AL/45-GG-KD-ENGR	GUN METAL GREY
500-AL/45-GN-KD	500-AL/45-GN-KD-ENGR	GREEN
500-AL/45-OR-KD	500-AL/45-OR-KD-ENGR	ORANGE
500-AL/45-PK-KD	500-AL/45-PK-KD-ENGR	PINK
500-AL/45-RD-KD	500-AL/45-RD-KD-ENGR	RED
500-AL/45-SI-KD	500-AL/45-SI-KD-ENGR	SILVER



(ALB) ALL LESS BARREL - PADLOCK 'AL13' - S/STEEL SHKL.



Art ID	Engraved Art ID.	Finish
500-AL/45-BK-ALB	500-AL/45-BK-ALB-ENGR	BLACK
500-AL/45-BL-ALB	500-AL/45-BL-ALB-ENGR	BLUE
500-AL/45-GG-ALB	500-AL/45-GG-ALB-ENGR	GUN METAL GREY
500-AL/45-GN-ALB	500-AL/45-GN-ALB-ENGR	GREEN
500-AL/45-OR-ALB	500-AL/45-OR-ALB-ENGR	ORANGE
500-AL/45-PK-ALB	500-AL/45-PK-ALB-ENGR	PINK
500-AL/45-RD-ALB	500-AL/45-RD-ALB-ENGR	RED
500-AL/45-SI-ALB	500-AL/45-SI-ALB-ENGR	SILVER



(KD) KEYED TO DIFFER - PADLOCK HANG PACK 'AL13' - S/STEEL SHKL.



Art ID	Engraved Art ID.	Finish
500-AL/45-BK-KD-HP	500-AL/45-BK-KD-HP-ENGR	BLACK
500-AL/45-GG-KD-HP	500-AL/45-GG-KD-HP-ENGR	GUN METAL GREY
500-AL/45-SI-KD-HP	500-AL/45-SI-KD-HP-ENGR	SILVER





Art ID. SS06-BLK



Art ID. SS06-SS

STRIKE SHIELD (Blocker Plate) to suit 60mm Mortice & 127mm B/Set Locksets (VISIBLE Fix)

Secured with a S/Steel 8mm Ø M5 x 30mm cup head bolt

Product Specification:

- Material: Stainless Steel
- Thickness: 2mm
- Size (H X W): 275mm x 75mm
- Pack Quantity: 1 x Plate
- Mounting: Visible Fix
- Comes with required bolts
- Secured with a S/Steel 8mm Ø M5 x 30mm cup head bolt
- Application: Suits 60mm Mortice Locks & 127mm Backset Locks



Art ID. SS03-BLK



Art ID. SS03-SS

STRIKE SHIELD (Blocker Plate) to suit 60mm Mortice & 127mm B/Set Locksets (Concealed Fix)

Product Specification:

- Material: Stainless Steel
- Thickness: 2mm
- Size (H X W): 275mm x 75mm
- Pack Quantity: 1 x Plate
- Mounting: Concealed Fix
- Comes with required bolts
- Application: Suits 60mm Mortice Locks & 127mm Backset Locks



Art ID. SS50-BLK



Art ID. SS50-SS

2mm PACKING PLATE to Suit LOCKTON Strike Shields (Blocker Plates)

Product Specification:

- Material: Stainless Steel
- Finish: Matte Black
- Thickness: 2mm
- Dimensions: 275 x 29mm
- Pack Quantity: 1 x Plate
- Application: Packs out Strike Shields by an extra 2mm
Suits Art ID. SS01, SS02, SS03 & SS06





Art ID. SS04-BLK



Art ID. SS04-SS

STRIKE SHIELD (Blocker Plate) to suit Narrow Stile Mortice Furniture (Visible Fix)

Secured with a S/Steel 8mm Ø M5 x 30mm cup head bolt

Product Specification:

- Material: Stainless Steel
- Thickness: 2mm
- Size (H X W): 275mm x 75mm
- Pack Quantity: 1 x Plate
- Mounting: Visible Fix
- Comes with required bolts
- Secured with a S/Steel 8mm Ø M5 x 30mm cup head bolt
- Application: Suits Narrow Stile Mortice Furniture



Art ID. SS01-BLK



Art ID. SS01-SS

STRIKE SHIELD (Blocker Plate) to suit Locksets (Visible Fix)

Secured with a S/Steel 8mm Ø M5 x 30mm cup head bolt

Product Specification:

- Material: Stainless Steel
- Thickness: 2mm
- Size (H X W): 275mm x 75mm
- Pack Quantity: 1 x Plate
- Mounting: Visible Fix
- Comes with required bolts
- Secured with a S/Steel 8mm Ø M5 x 30mm cup head bolt
- Application: Suits Cylindrical Locks (cut-out for rose)



2-Hours



Art ID. SS02-BLK



Art ID. SS02-SS

STRIKE SHIELD (Blocker Plate) to suit Locksets (Concealed Fix)

Product Specification:

- Material: Stainless Steel
- Thickness: 2mm
- Size (H X W): 275mm x 75mm
- Pack Quantity: 1 x Plate
- Mounting: Concealed Fix
- Comes with required bolts
- Application: Suits Cylindrical Locks (cut-out for rose)



2-Hours





NEW

'Heavy Duty' DOOR HINGE 100x 75mm (3.2mm) *304 Stainless Steel*

Product Description:

*This high quality Hinge is made of 304 Stainless Steel giving it the strength and durability required to make it a long lasting addition to most door applications, especially heavy solid core fire rated doors or doors fitted with door closers up to **100 kilograms**.*

The ball bearing assembly enables smoother and more fluid movements in comparison with fixed pin models.

Product Specification:

- Dimensions (L x W x T): 100 x 75 x 3.2mm
- Material: 304 Stainless Steel
- Finish: Satin Stainless Steel
- Suits Left & Right Handed Doors
- Max Door Weight: 100kgs
- Supplied with: 8 x Timber Fixing Screws & 4 x Metal Fixing Screws
- 10 Year Warranty (*)



Art ID:HG-HD100-075-SSS

QTY
5



QTY
5

Art ID:HG-HD100-075-BLK

10 YEARS
WARRANTY

 2-Hours

NEW

'Heavy Duty' DOOR HINGE 100x 100mm (3.2mm) *304 Stainless Steel*

Product Description:

*This high quality Hinge is made of 304 Stainless Steel giving it the strength and durability required to make it a long lasting addition to most door applications, especially heavy solid core fire rated doors or doors fitted with door closers up to **100 kilograms**.*

The ball bearing assembly enables smoother and more fluid movements in comparison with fixed pin models.

Product Specification:

- Dimensions (L x W x T): 100 x 100 x 3.2mm
- Material: 304 Stainless Steel
- Finish: Satin Stainless Steel
- Suits Left & Right Handed Doors
- Max Door Weight: 100kgs
- Supplied with: 8 x Timber Fixing Screws & 4 x Metal Fixing Screws
- 10 Year Warranty (*)



Art ID:HG-HD100-100-SSS

QTY
5



QTY
5

Art ID:HG-HD100-100-BLK

10 YEARS
WARRANTY

 2-Hours



NEW

'Ball Bearing' DOOR HINGE 100x 75mm (2.5mm) *304 Stainless Steel*



Product Description:

*This high quality Hinge is made of 304 Stainless Steel giving it the strength and durability required to make it a long lasting addition to most door applications, especially fire rated doors or doors fitted with door closers up to **80 kilograms**.*

The ball bearing assembly enables smoother and more fluid movements in comparison with fixed pin models.

Product Specification:

- Dimensions (L x W x T): 100 x 75 x 2.5mm
- Material: 304 Stainless Steel
- Finish: Satin Stainless Steel
- Suits Left & Right Handed Doors
- Max Door Weight: 80kgs
- Supplied with: 8 x Timber Fixing Screws & 4 x Metal Fixing Screws
- 10 Year Warranty (*)

Art ID:HG-BB100-075-SSS

QTY
\$



QTY
\$

Art ID:HG-BB100-075-BLK

10 YEARS
WARRANTY

 2-Hours

NEW

'Ball Bearing' DOOR HINGE 100x 100mm (2.5mm) *304 Stainless Steel*



Product Description:

*This high quality Hinge is made of 304 Stainless Steel giving it the strength and durability required to make it a long lasting addition to most door applications, especially fire rated doors or doors fitted with door closers up to **80 kilograms**.*

The ball bearing assembly enables smoother and more fluid movements in comparison with fixed pin models.

Product Specification:

- Dimensions (L x W x T): 100 x 100 x 2.5mm
- Material: 304 Stainless Steel
- Finish: Satin Stainless Steel
- Suits Left & Right Handed Doors
- Max Door Weight: 80kgs
- Supplied with: 8 x Timber Fixing Screws & 4 x Metal Fixing Screws
- 10 Year Warranty (*)

Art ID:HG-BB100-100-SSS

QTY
\$



QTY
\$

Art ID:HG-BB100-100-BLK

10 YEARS
WARRANTY

 2-Hours



NEW



'Fixed Pin' DOOR HINGE 100x 75mm (2.5mm) *304 Stainless Steel*

Product Description:

*This high quality Hinge is made of 304 Stainless Steel giving it the strength and durability required to make it a long lasting addition to most door applications, especially entrance doors or any door that opens outwards up to **80 kilograms**.*

Product Specification:

- Dimensions (L x W x T): 100 x 75 x 2.5mm
- Material: 304 Stainless Steel
- Finish: Satin Stainless Steel
- Suits Left & Right Handed Doors
- Max Door Weight: 80kgs
- Supplied with: 8 x Timber Fixing Screws & 4 x Metal Fixing Screws
- 10 Year Warranty (*)

Art ID:HG-FP100-075-SSS

QTY
\$



Art ID:HG-FP100-075-BLK

QTY
\$

10 YEARS
WARRANTY

 2-Hours

NEW



'Fixed Pin' DOOR HINGE 100x 100mm (2.5mm) *304 Stainless Steel*

Product Description:

*This high quality Hinge is made of 304 Stainless Steel giving it the strength and durability required to make it a long lasting addition to most door applications, especially entrance doors or any door that opens outwards up to **80 kilograms**.*

Product Specification:

- Dimensions (L x W x T): 100 x 100 x 2.5mm
- Material: 304 Stainless Steel
- Finish: Satin Stainless Steel
- Suits Left & Right Handed Doors
- Max Door Weight: 80kgs
- Supplied with: 8 x Timber Fixing Screws & 4 x Metal Fixing Screws
- 10 Year Warranty (*)

Art ID:HG-FP100-100-SSS

QTY
\$



Art ID:HG-FP100-100-BLK

QTY
\$

10 YEARS
WARRANTY

 2-Hours



Swing Bolt Range



Art ID.
590ML-ESC-PR-SCP

Art ID.
590ML-ESC-PR-BLK

'Premium' ESCUTCHEON to suit 590 Mortice Locks (Swing Bolts)

Product Description:

These high quality escutcheons are screwed onto the door to ensure longevity and prevent any smudging or marks on surface of oval cylinder during fitting.

Product Specification:

- Supplied with: 4 x Mounting Screws, 2 x Cylinder Screws & 1 x 'Rabbit Ear' Cam



Art ID.
590ML-ESC

'Push On' ESCUTCHEON to suit 590 Deadlock Mortice Locks

Product Description:

LOCKTON Oval Cylinder Escutcheon to suit the LOCKTON 590ML Range of Deadlock Mortice Locks.

Product Specification:

- Finish: Satin Chrome

Escutcheons are push mounted onto the oval cylinders.



Art ID.
590CYL-EL-SC



Art ID.
590CYL-EL-BLK

590 Mortice Lock OVAL CYL. ESCAPE LEVER

Product Specification:

- Material: Solid Brass
- Reversible Handing
- Lever Length: 100mm
- Satin Chrome Finish
- Comes with "Rabbit Ear" Cams
- Meets the requirements of AS1428.1-2009, design for access and mobility
- 10 Year Warranty (*)



Design for Access and mobility - AS1428.1-2009



Art ID.
590CYL-13VDA-SC



Art ID.
590CYL-13VDA-BLK

590 Mortice Lock OVAL CYL. TURN SNIB

Product Specification:

- Material: Solid Brass
- Reversible Handing
- Snib Length: 55mm
- Satin Chrome Finish
- Comes with "Rabbit Ear" Cams
- Meets the requirements of AS1428.1-2009, design for access and mobility
- 10 Year Warranty (*)



Design for Access and mobility - AS1428.1-2009



FULL RANGE OF (590) SWINGBOLTS 22mm, 28mm, 36mm Bolt & Hook





Art. DB6090-PANIC

FREE

for Stockists

* Talk to your Sales Manager to order.



Art. DB6090-ML



Art. DB6090-SBML



Art. DB6090-BLK



Art. DB6090-162



Art. DB3060-AL13



Art. DB6090-PADLOCKS



Art. DB6090-CLOSER



Art. DB6090-CAM

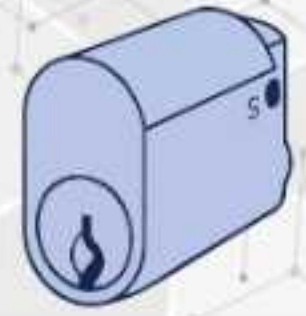

Oval Cylinder range - Satin Chrome



LOCK CYLINDER (570) OVAL *Satin Chrome*

Art ID.	Description
410-SC-KA1	LOCK CYLINDER (570) OVAL (KA) *Satin Chrome*
410-SC-KA2	LOCK CYLINDER (570) OVAL (KA) *Satin Chrome*
410-SC-KA3	LOCK CYLINDER (570) OVAL (KA) *Satin Chrome*
410-SC-KD	LOCK CYLINDER (570) OVAL (KD) *Satin Chrome*



4-Hours



LOCK CYLINDER (570) OVAL (ALB) *Satin Chrome*

Art ID.	Description
410-SC-ALB	LOCK CYLINDER (570) OVAL (ALB) *Satin Chrome*



4-Hours



LOCK CYLINDER (570) OVAL - M4 Thread *Satin Chrome*

Art ID.	Description
410-SC-KA1-M4	LOCK CYLINDER (570) OVAL (KA1) M4 Thread *Satin Chrome*
410-SC-KA2-M4	LOCK CYLINDER (570) OVAL (KA2) M4 Thread *Satin Chrome*
410-SC-KD-M4	LOCK CYLINDER (570) OVAL (KD) M4 Thread *Satin Chrome*



4-Hours



LOCK CYLINDER (570) OVAL (ALB) M4 Thread *Satin Chrome*

Art ID.	Description
410-SC-ALB-M4	LOCK CYLINDER (570) OVAL (ALB) M4 Thread *Satin Chrome*



4-Hours



Oval Cylinder range - Satin Chrome



Spare BLANK BARREL - Suite Oval Cylinder - 'No Key Broaching' *Satin Chrome*

Art ID.	Description
410-SC-BLANK	Spare BLANK BARREL - Suite Oval Cylinder - 'No Key Broaching' *Satin Chrome*



Spare BARREL Lock Cylinder (570) Oval *Satin Chrome*

Art ID.	Description
410-SC-BRL	Spare BARREL Lock Cylinder (570) Oval *Satin Chrome*



LOCK CYLINDER (590) OVAL (TURN SNIB) *Satin Chrome*

Art ID.	Description
410-SC-TURN	LOCK CYLINDER (590) OVAL (TURN SNIB) *Satin Chrome*



LOCK CYLINDER (570) OVAL (KD) 50mm Extended *Satin Chrome*

Art ID.	Description
410/50-SC-KA1	LOCK CYLINDER (570) OVAL (KA) 50mm Extended *Satin Chrome*
410/50-SC-KD	LOCK CYLINDER (570) OVAL (KD) 50mm Extended *Satin Chrome*





Oval Cylinder range



LOCK CYLINDER (570) OVAL *Black*

Art ID.	Description
410-BLK-KA1	LOCK CYLINDER (570) OVAL (KA) *Matte Black*
410-BLK-KD	LOCK CYLINDER (570) OVAL (KD) *Matte Black*



LOCK CYLINDER (570) OVAL (KD) 50mm Extended *Black*

Art ID.	Description
410/50-BLK-KA1	LOCK CYLINDER (570) OVAL (KA) 50mm Extended *Matte Black*
410/50-BLK-KD	LOCK CYLINDER (570) OVAL (KD) 50mm Extended *Matte Black*



LOCK CYLINDER (570) OVAL - M4 Thread *Black*

Art ID.	Description
410-BLK-KD-M4	LOCK CYLINDER (570) OVAL (KD) M4 Thread *Matte Black*



LOCK CYLINDER (570) OVAL (KA) *Chrome Plate*

Art ID.	Description
410-CP-KA1	LOCK CYLINDER (570) OVAL (KA) *Chrome Plate*
410-CP-KD	LOCK CYLINDER (570) OVAL (KD) *Chrome Plate*





Oval Cylinder range



LOCK CYLINDER (570) OVAL (ALB) *Chrome Plate*

Art ID.	Description
410-CP-ALB	LOCK CYLINDER (570) OVAL (ALB) *Chrome Plate*



LOCK CYLINDER (570) OVAL (KD) *Polished Brass*



Art ID.	Description
410-PB-KA1	LOCK CYLINDER (570) OVAL (KA) *Polished Brass*
410-PB-KD	LOCK CYLINDER (570) OVAL (KD) *Polished Brass*



OVAL (570) CYL. - Laser Engraved



Art ID.	Description
410-50-SC-KA1-ENGR	OVAL (570) CYL. 50mm Extend. (BOX OF 10) *Satin Chrome* - Laser Engraved
410-50-SC-KD-ENGR	OVAL (570) CYL. 50mm Extend. (BOX OF 10) *Satin Chrome* - Laser Engraved
410-SC-ALB-ENGR	OVAL (570) CYL. (BOX OF 10) *Satin Chrome* - Laser Engraved
410-SC-ALB-M4-ENGR	OVAL (570) CYL. M4 Thread (BOX OF 10) *Satin Chrome* - Laser Engraved
410-SC-KA1-ENGR	OVAL (570) CYL. (BOX OF 10) *Satin Chrome* - Laser Engraved
410-SC-KA1-M4-ENGR	OVAL (570) CYL. M4 Thread (BOX OF 10) *Satin Chrome* - Laser Engraved
410-SC-KA2-ENGR	OVAL (570) CYL. (BOX OF 10) *Satin Chrome* - Laser Engraved
410-SC-KA2-M4-ENGR	OVAL (570) CYL. M4 Thread (BOX OF 10) *Satin Chrome* - Laser Engraved
410-SC-KA3-ENGR	OVAL (570) CYL. (BOX OF 10) *Satin Chrome* - Laser Engraved
410-SC-KD-ENGR	OVAL (570) CYL. (BOX OF 10) *Satin Chrome* - Laser Engraved
410-SC-KD-M4-ENGR	OVAL (570) CYL. M4 Thread (BOX OF 10) *Satin Chrome* - Laser Engraved
410-SC-TURN-ENGR	OVAL (570) CYL. (BOX OF 10) *Satin Chrome* - Laser Engraved
410-BLK-KA1-ENGR	OVAL (570) CYL. (BOX OF 10) *Matte Black* - Laser Engraved
410-BLK-KD-ENGR	OVAL (570) CYL. (BOX OF 10) *Matte Black* - Laser Engraved
410-CP-ALB-ENGR	OVAL (570) CYL. (BOX OF 10) *Chrome Plate* - Laser Engraved
410-CP-KA1-ENGR	OVAL (570) CYL. (BOX OF 10) *Chrome Plate* - Laser Engraved
410-CP-KD-ENGR	OVAL (570) CYL. (BOX OF 10) *Chrome Plate* - Laser Engraved
410-PB-KA1-ENGR	OVAL (570) CYL. (BOX OF 10) *Polished Brass* - Laser Engraved
410-PB-KD-ENGR	OVAL (570) CYL. (BOX OF 10) *Polished Brass* - Laser Engraved



5-Pin Round Cylinder range

LOCK CYLINDER (201) ROUND 5-Pin *Satin Chrome*



Art ID.	Description
420-5P-SC-KA1	LOCK CYLINDER (201) ROUND 5-Pin (KA) *Satin Chrome*
420-5P-SC-KD	LOCK CYLINDER (201) ROUND 5-Pin (KD) *Satin Chrome*

LOCK CYLINDER (201) ROUND 5-Pin (KD) *Matte Black*



Art ID.	Description
420-5P-BLK-KD	LOCK CYLINDER (201) ROUND 5-Pin (KD) *Matte Black*

LOCK CYLINDER (201) ROUND 5-Pin *Polished Brass*



Art ID.	Description
420-5P-PB-KA1	LOCK CYLINDER (201) ROUND 5-Pin (KA) *Polished Brass*
420-5P-PB-KD	LOCK CYLINDER (201) ROUND 5-Pin (KD) *Polished Brass*



6-Pin Round Cylinder range

LOCK CYLINDER (201) ROUND *Satin Chrome*



Art ID.	Description
420-SC-KA1	LOCK CYLINDER (201) ROUND (KA) *Satin Chrome*
420-SC-KA2	LOCK CYLINDER (201) ROUND (KA) *Satin Chrome*
420-SC-KA3	LOCK CYLINDER (201) ROUND (KA) *Satin Chrome*
420-SC-KD	LOCK CYLINDER (201) ROUND (KD) *Satin Chrome*



LOCK CYLINDER (201) ROUND (ALB) *Satin Chrome*

Art ID.	Description
420-SC-ALB	LOCK CYLINDER (201) ROUND (ALB) *Satin Chrome*



LOCK CYLINDER (201) ROUND (KD) *Matte Black*

Art ID.	Description
420-BLK-KD	LOCK CYLINDER (201) ROUND (KD) *Matte Black*



LOCK CYLINDER (201) ROUND *Chrome Plate*

Art ID.	Description
420-CP-KA1	LOCK CYLINDER (201) ROUND (KA) *Chrome Plate*
420-CP-KD	LOCK CYLINDER (201) ROUND (KD) *Chrome Plate*
420-CP-ALB	LOCK CYLINDER (201) ROUND (ALB) *Chrome Plate*

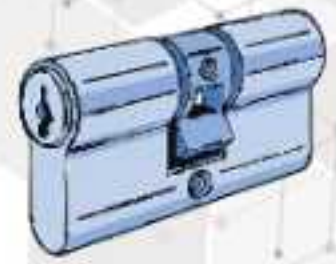

5 - Pin EURO Cylinder range



LOCK CYLINDER - DBL EURO FIXED - 5-PIN *Satin Chrome*

Art ID.	Description
495-1-SC-KA1	LOCK CYLINDER - DBL EURO FIXED - 5-PIN *Satin Chrome* (KA)
495-1-SC-KD	LOCK CYLINDER - DBL EURO FIXED - 5-PIN *Satin Chrome* (KD)



LOCK CYLINDER - DBL EURO FIXED - 5-PIN *Matte Black*

Art ID.	Description
495-1-BLK-KA1	LOCK CYLINDER - DBL EURO FIXED - 5-PIN *Matte Black* (KA)
495-1-BLK-KD	LOCK CYLINDER - DBL EURO FIXED - 5-PIN *Matte Black* (KD)



LOCK CYLINDER - DBL EURO FIXED - 5-Pin (KA)

Art ID.	Description
495-1-CP-KA1	LOCK CYLINDER - DBL EURO FIXED - 5-Pin (KA)
495-1-CP-KD	LOCK CYLINDER - DBL EURO FIXED - 5-Pin (KD)



LOCK CYLINDER - SINGLE EURO FIXED - 5-PIN *Satin Chrome* (KA)

Art ID.	Description
495-2-SC-KA1	LOCK CYLINDER - SINGLE EURO FIXED - 5-PIN *Satin Chrome* (KA)
495-2-SC-KD	LOCK CYLINDER - SINGLE EURO FIXED - 5-PIN *Satin Chrome* (KD)



5 - Pin EURO CYLINDERS



LOCK CYLINDER - SINGLE EURO FIXED - 5-PIN *Matte Black*

Art ID.	Description
495-2-BLK-KA1	LOCK CYLINDER - SINGLE EURO FIXED - 5-PIN *Matte Black* (KA)
495-2-BLK-KD	LOCK CYLINDER - SINGLE EURO FIXED - 5-PIN *Matte Black* (KD)



LOCK CYLINDER - SINGLE EURO FIXED - 5-PIN *Chrome Plate*

Art ID.	Description
495-2-CP-KA1	LOCK CYLINDER - SINGLE EURO FIXED - 5-PIN *Chrome Plate* (KA)
495-2-CP-KD	LOCK CYLINDER - SINGLE EURO FIXED - 5-PIN *Chrome Plate* (KD)



LOCK CYLINDER - DBL EURO LAZY - 5-Pin (KA)

Art ID.	Description
495-3-CP-KA1	LOCK CYLINDER - DBL EURO LAZY - 5-Pin (KA)
495-3-CP-KA2	LOCK CYLINDER - DBL EURO LAZY - 5-Pin (KA)
495-3-CP-KAR	BOX of 10 - LOCK CYLINDERS - DBL EURO LAZY 5-Pin (KA RANDOM)
495-3-CP-KD	LOCK CYLINDER - DBL EURO LAZY - 5-Pin (KD)

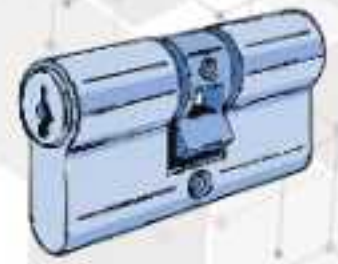

6 - Pin EURO - Tri-Lock Cylinder range



LOCK CYLINDER - DBL. TRILOCK *Chrome Plate*

Art ID.	Description
490-TRI-CP-KA1	LOCK CYLINDER - DBL. TRILOCK (KA)
490-TRI-CP-KA2	LOCK CYLINDER - DBL. TRILOCK (KA)
490-TRI-CP-KD	LOCK CYLINDER - DBL. TRILOCK (KD)



LOCK CYLINDER - DBL. TRILOCK *Satin Chrome* (KD)

Art ID.	Description
490-TRI-SC-KD	LOCK CYLINDER - DBL. TRILOCK *Satin Chrome* (KD)





6 - Pin EURO CYLINDERS

LOCK CYLINDER - (9555-1) DBL EURO FIXED 6-Pin *Satin Chrome*



Art ID.	Description
496-1-SC-KD	LOCK CYLINDER - (9555-1) DBL EURO FIXED 6-Pin *Satin Chrome* (KD)



LOCK CYLINDER - (9555-1) DBL EURO FIXED 6-Pin *Matte Black *(KD)

Art ID.	Description
496-1-BLK-KD	LOCK CYLINDER - (9555-1) DBL EURO FIXED 6-Pin *Matte Black *(KD)



LOCK CYLINDER - (9555-1) DBL EURO FIXED 6-Pin *Chrome Plate

Art ID.	Description
496-1-CP-ALB	LOCK CYLINDER - (9555-1) DBL EURO FIXED 6-Pin (ALB)
496-1-CP-KA1	LOCK CYLINDER - (9555-1) DBL EURO FIXED 6-Pin (KA)
496-1-CP-KD	LOCK CYLINDER - (9555-1) DBL EURO FIXED 6-Pin (KD)



LOCK CYLINDER - (9555-2) SINGLE EURO FIXED 6-Pin *Satin Chrome*

Art ID.	Description
496-2-SC-KD	LOCK CYLINDER - (9555-2) SINGLE EURO FIXED 6-Pin *Satin Chrome* (KD)



6 - Pin EURO Cylinder range



LOCK CYLINDER - (9555-2) SINGLE EURO FIXED 6-Pin * Matte Black *(KD)

Art ID.	Description
496-2-BLK-KD	LOCK CYLINDER - (9555-2) SINGLE EURO FIXED 6-Pin * Matte Black *(KD)



LOCK CYLINDER - (9555-2) SINGLE EURO FIXED 6-Pin * Chrome Plate *

Art ID.	Description
496-2-CP-KA1	LOCK CYLINDER - (9555-2) SINGLE EURO FIXED 6-Pin (KA)
496-2-CP-KD	LOCK CYLINDER - (9555-2) SINGLE EURO FIXED 6-Pin (KD)



LOCK CYLINDER - (9555-2) SINGLE EURO FIXED 6-Pin *Chrome Plate*

Art ID.	Description
496-2-CP-ALB	LOCK CYLINDER - (9555-2) SINGLE EURO FIXED 6-Pin (ALB)



LOCK CYLINDER - (9555-3) DBL EURO LAZY 6-Pin (KA) * Chrome Plate *

Art ID.	Description
496-3-CP-KA1	LOCK CYLINDER - (9555-3) DBL EURO LAZY 6-Pin (KA)



6 - Pin EURO CYLINDERS

LOCK CYLINDER - (9555-3) DBL EURO LAZY 6-Pin (ALB)



Art ID.	Description
496-3-CP-ALB	LOCK CYLINDER - (9555-3) DBL EURO LAZY 6-Pin (ALB)



LOCK CYLINDER - (9555-5) HALF EURO FIXED- 6-Pin *Satin Chrome*

Art ID.	Description
496-5-SC-KA1	LOCK CYLINDER - (9555-5) HALF EURO FIXED- 6-Pin *Satin Chrome* (KA)
496-5-SC-KD	LOCK CYLINDER - (9555-5) HALF EURO FIXED- 6-Pin *Satin Chrome* (KD)



LOCK CYLINDER - (9555-5) HALF EURO FIXED- 6-Pin *Matte black*

Art ID.	Description
496-5-BLK-KA1	LOCK CYLINDER - (9555-5) HALF EURO FIXED- 6-Pin * Matte Black * (KA)
496-5-BLK-KD	LOCK CYLINDER - (9555-5) HALF EURO FIXED- 6-Pin * Matte Black * (KD)

LOCK CYLINDER JIG - Suit LOCKTON EURO Cylinders



Art ID. 496-JIG

Product Description:

LOCKTON Art. 496-JIG is made to suit the LOCKTON range of EURO Cylinders like the Art. 496-1-CP-ALB - Fixed Cam Euro Cyl Less Barrel.

The Jig allows you to remove the barrel & or plastic sleeve to allow you to swap over barrels or insert a restricted barrel, without dropping all of the top springs and pins.

Product Specification:

- Material: PLA+
- Accepts the range of LOCKTON EURO cylinders



PD Cylinders



LOCK CYLINDER - PD CYL - TE2 Keyway (KA)

Art ID.	Description
440-2-CP-KA1	LOCK CYLINDER - PD CYL - TE2 Keyway (KA)

LOCK CYLINDER - PD CYL. (KA)



Art ID.	Description
440-1-SC-KA1	LOCK CYLINDER - PD CYL. (KA)

LOCK CYLINDER - PD CYL. (ALB)



Art ID.	Description
440-1-SC-ALB	LOCK CYLINDER - PD CYL. (ALB)

530 Cylinders



LOCK CYLINDER - 530 CYL. (KA)

Art ID.	Description
430-SC-KA1	LOCK CYLINDER - 530 CYL. (KA)

LOCK CYLINDER - 530 CYL. (ALB)



Art ID.	Description
430-SC-ALB	LOCK CYLINDER - 530 CYL. (ALB)



LOCKTON

E - S e r i e s





'E-Series' (G2) GATEWAY / BRIDGE (WiFi Connector) - 2.4 GHz

G2-GATE



IN THE BOX:



PRODUCT SPECIFICATION

- Dimensions: 70 x 70 x 26mm
- Network: WiFi 2.4G
- IEEE Standard: 802.11 b/g/n
- Power Connection: Type C USB
- Power Input: 5V/500mA
- Bluetooth Signal Range: 10-15 metres
- 3 Year Warranty (*)

Components

- G2 Smart Lock Gateway
- USB-C Power Cable
- USB Charger Block
- Programming Instructions

Art ID. G2-GATE

'E-Series' (G3) GATEWAY / BRIDGE (ETHERNET Internet Connection)

G3-GATE



IN THE BOX:



PRODUCT SPECIFICATION

- Dimensions: 70 x 70 x 26mm
- Network Interface: RJ45 10M (Ethernet)
- IEEE Standard: 802.11 b/g/n
- Power Connection: Type-C USB
- Power Input: DC 5V/500mA
- Bluetooth Signal Range: 10-15 metres
- 3 Year Warranty (*)

Components

- G3 Smart Lock Gateway
- USB-C Power Cable
- USB Charger Block
- Programming Instructions

Art ID. G3-GATE

'E-Series' (G3) GATEWAY / BRIDGE (ETHERNET Internet Connection) - POWER over Ethernet

G3P-GATE (PoE)



IN THE BOX:



PRODUCT SPECIFICATION

- Dimensions: 70 x 70 x 26mm
- Network Interface: RJ45 10/100M PoE (Ethernet)
- IEEE Standard: 802.3
- Power Connection: Type-C USB (PoE)
- Power Input: DC 5V/500mA
- Bluetooth Signal Range: 10-15 metres
- 3 Year Warranty (*)

Components

- G3P Smart Lock Gateway
- USB-C Power Cable
- USB Charger Block
- Programming Instructions

Art ID. G3P-GATE

'E-Series' (G4) GATEWAY / BRIDGE (4G SIM Internet Connection)

G4-GATE



IN THE BOX:



PRODUCT SPECIFICATION

- Dimensions: 110 x 110 x 35mm
- Network Interface: 4G LTE / WiFi 2.4G
- Power Connection: Micro USB
- Power Input: DC 5V/500mA
- Bluetooth Signal Range: 10-15 metres
- 3 Year Warranty (*)

Components

- G4 Smart Lock Gateway
- Micro USB Power Cable
- USB Charger Block
- Programming Instructions

Art ID. G4-GATE

'E-Series' (G5) GATEWAY / BRIDGE (WiFi Connector) - Dual Band: 2.4 GHz & 5 GHz

G5-GATE



IN THE BOX:



PRODUCT SPECIFICATION

- Dimensions: 75 x 75 x 24mm
- Network: Dual Band WiFi 2.4G / 5G
- IEEE Standard: 802.11 b/g/n/ac/ax
- Power Connection: Type C USB
- Power Input: 5V/500mA
- Bluetooth Signal Range: 10-15 metres
- 3 Year Warranty (*)

Components

- G5 Smart Lock Gateway
- USB-C Power Cable
- USB Charger Block
- Programming Instructions

Art ID. G5-GATE



SMART KEYPAD - Wide - With Fingerscan

PRODUCT DESCRIPTION

LOCKTON 'E-Series' Wide Smart Keypad with Fingerprint, Digital PIN Code, RFID Tag and Mobile App Functionality

The stand-alone design and ease of installation will open more opportunities on job sites

This Smart keypad comes with a built-in single door controller, saving costs on material, labour and additional components

Designed with a market standard footprint to upgrade smart functionality on existing keypads and readers

Compatible with the majority of electric strikes, maglocks and other access control mediums on the market

IP67 Rating on keypad means it can be installed in almost any application

Easily use and manage the keypad via TTLOCK Phone App. Open the Lock, Add Users, Issue Temporary Codes and lots more

More Smart keypads / Doors can be added using the TTLock platform

Add up to 2600 x Users

Fingerprint sensing area is ergonomically located at the top of the keypad to naturally read a thumb print for quick entry

Optional G2 & G3 Gateway accessories allow for remote access and control of lock via internet

Bluetooth E-keys: Unlimited

Supplied with:

- 1 x Installation Pack (4 x Screws, 4 x Wall Plugs & 1 x Allen Key)
- 1 x Instruction Manual
- 2 x LOCKTON E-Series RFID Tags



Art ID. SKP-W1-FS



3-YEAR WARRANTY

IP67 RATING

PRODUCT SPECIFICATION

- Finish: Grey Body with Black Keypad & Sensing Areas
- Dimensions (W x H x D): 80 x 126 x 19mm
- Supporting Systems: Android 4.3 / iOS 7.0 & Above
- Stand-by Current: 28mA
- Operating Current: ≈ 1A
- Power Supply: DC 12V
- IP Rating: IP67
- RFID Tag Capacity: 2000
- PIN Code Capacity: 500
- Fingerprint Capacity: 100
- Bluetooth E-Keys: Unlimited

SMART KEYPAD - Narrow - With Fingerscan

PRODUCT DESCRIPTION

LOCKTON 'E-Series' Narrow Smart Keypad with Fingerprint, Digital PIN Code, RFID Tag and Mobile App Functionality

The stand-alone design and ease of installation will open more opportunities on job sites

This Smart keypad comes with a built-in single door controller, saving costs on material, labour and additional components

Designed with a market standard footprint to upgrade smart functionality on existing keypads and readers

Compatible with the majority of electric strikes, maglocks and other access control mediums on the market

IP66 Rating on keypad means it can be installed in almost any application

Easily use and manage the keypad via TTLOCK Phone App. Open the Lock, Add Users, Issue Temporary Codes and lots more

More Smart keypads / Doors can be added using the TTLock platform

Add up to 1350 x Users

Fingerprint sensing area is ergonomically located at the bottom of the keypad to naturally read a thumb print for quick entry.

Optional G2 & G3 Gateway accessories allow for remote access and control of lock via internet

Supplied with:

- 1 x Installation Pack (4 x Screws, 4 x Wall Plugs & 1 x Allen Key)
- 1 x IP66 Kit (45g Elec. Wiring Sealant)
- 1 x Instruction Manual
- 2 x LOCKTON E-Series RFID Tags



Art ID. SKP-N1-FS



3-YEAR WARRANTY

IP66 RATING

PRODUCT SPECIFICATION

- Finish: Silver body with Black keypad/sensing areas
- Dimensions (W x H x D): 43.5 x 148 x 22mm
- Supporting Systems: Android 4.3 / iOS 7.0 & Above
- Stand-by Current: 84mA
- Operating Current: ≈ 150mA
- Power Supply: DC 12V
- IP Rating: IP66
- RFID Tag Capacity: 1000
- PIN Code Capacity: 250
- Fingerprint Capacity: 100
- Bluetooth E-Keys: Unlimited



ELEV 36



Smart Door Lock
Art. **ELEV36**



VERSATILE



Convenient 6 Ways to Unlock!



Hinged Door Lock kit



Versatile

ELEV36 Can be ordered to suit Hinged or Sliding doors.

Suits:

- Backsets 25mm-70mm
- Door Thickness 28-50mm
- Pitch 85mm

IP66 Rating

IP66 rating on external handle means this lock can be installed in most applications.

Key Override

6-Pin C4 rekeyable Half-Euro Cylinder that can be converted to a restricted profile if required.

Control

ELEV36 operates on the TTLock platform. Use the phone app to, Open the Lock, Add Users, Issue Temporary Codes + Lots More. Manage & Add up to 300 users.



Sliding Door Lock kit



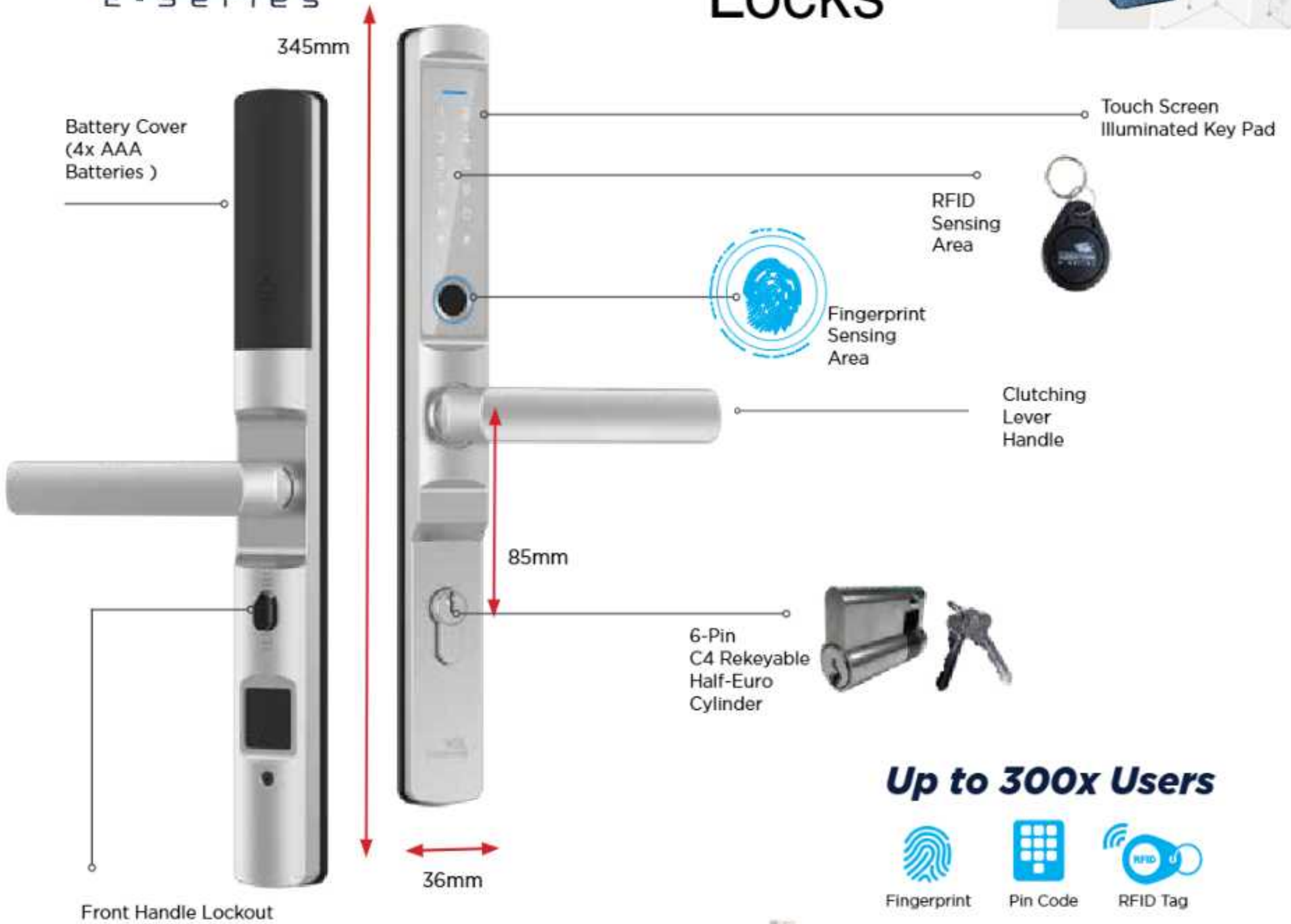

Secure & Easy Operation

The ELEV36 - Smart Euro Mortice Lock has double point locking & retrofits existing mortice locks.

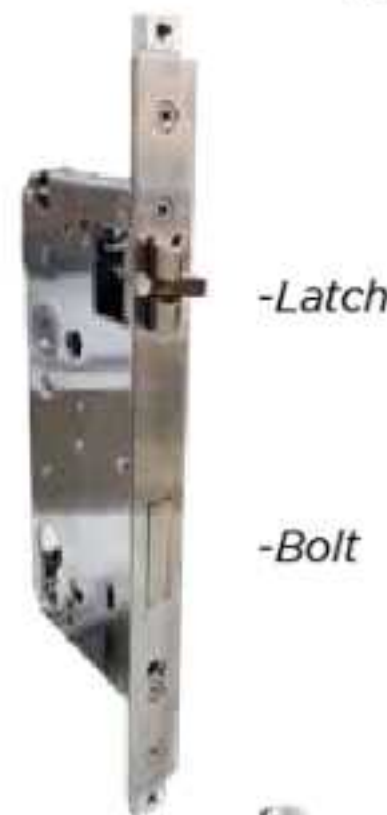

LOCKING

Latch automatically locks when the door is closed.



DEADLOCKING

The Bolt can be thrown by raising the Lever for increased security.



UNLOCKING

After unlocking, using the lever retracts the latch & the bolt in a single operation.



ELEV36 - IN THE BOX:

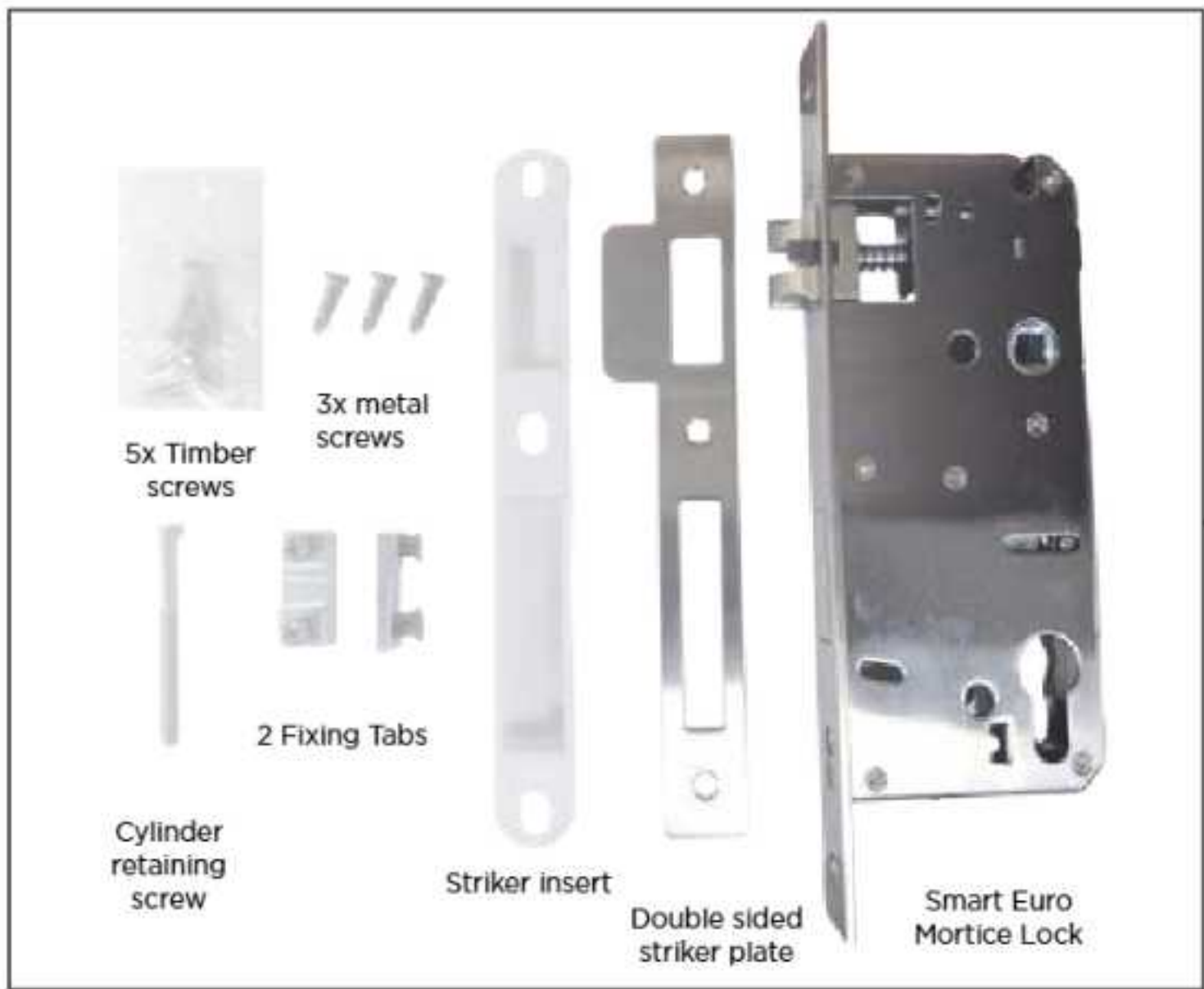



E L E V
ELECTRONIC LOCK EXTREMELY VERSATILE

HINGED DOOR APPLICATIONS



MORTICE LOCK OPTIONS



Available in B/Set:
25mm
28mm
30mm
35mm
40mm
45mm
50mm
60mm
65mm
70mm

ARCHITECTURAL HINGED DOOR APPLICATIONS



Can be configured Knobs both sides or Knob & Lever

SLIDING DOOR APPLICATIONS

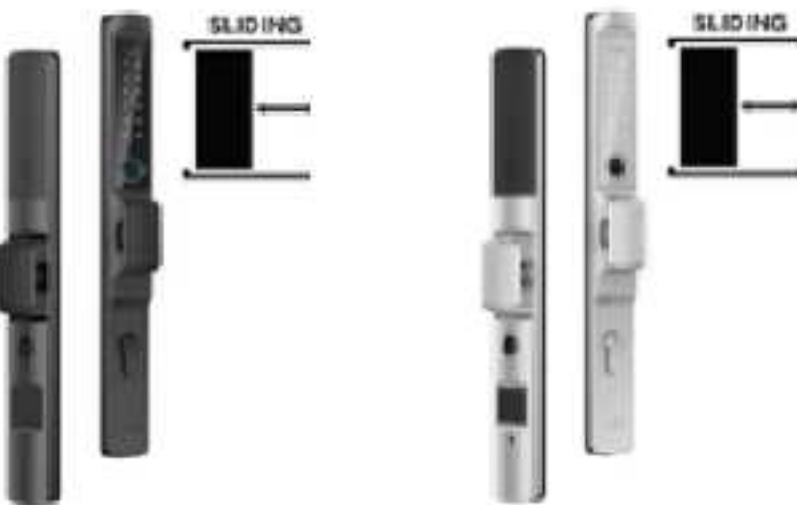

MORTICE LOCK OPTIONS

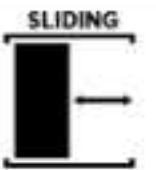

Available in B/Set:
20mm
28mm
35mm
45mm

INTERNET CONNECTIVITY OPTIONS



WiFi
G2, G5



Ethernet
G3 - G3P



SimCard
G4



Art. **ELEV36**

STD. ITEMS	RETROFIT OPTIONS	SCARPLATES
<p>STANDARD FACEPLATE (240 x 22mm)</p> <p>STANDARD STRIKE (200 x 24mm)</p> <p>Included with all ELEV36 hinged purchases</p>	<p>RETROFIT FACEPLATES</p>  <p>(210 x 24mm) (240 x 25mm) (260 x 25mm) (290 x 25mm)</p> <p>Each Faceplate size has 2 options:</p> <ul style="list-style-type: none"> • 1 that suits Backset 25-30mm • 1 that suits Backset 35-70mm <p>RETROFIT STRIKE (197 x 29mm)</p>	 <p>(377 x 70mm)</p> <p>(377 x 70mm)</p>

STD. ITEMS	RETROFIT OPTIONS	SCARPLATES
<p>STANDARD FACEPLATE (270 x 22mm)</p> <p>STANDARD STRIKE (190 x 15mm)</p> <p>Included with all ELEV36 hinged purchases</p>	<p>RETROFIT FACEPLATES</p>  <p>(270 x 25mm) (270 x 15mm)</p> <p>RETROFIT STRIKE (190 x 29mm)</p>	 <p>(377 x 70mm)</p>

RFID KEYFOBS



OR



Pkt. of 20
Custom
Branded





ELEV36 BLACK RANGE

'E-Series' SMART DOOR LOCK - (Hinged) *Black*



Art ID	Colour	Door Type	Backset	Description
ELEV36-BLK-H25	*Black*	Hinged	25mm	- Incl. ELEV36 Handle set, 25mm Smart Euro Mortice Lock & Cylinder
ELEV36-BLK-H28	*Black*	Hinged	28mm	- Incl. ELEV36 Handle set, 28mm Smart Euro Mortice Lock & Cylinder
ELEV36-BLK-H30	*Black*	Hinged	30mm	- Incl. ELEV36 Handle set, 30mm Smart Euro Mortice Lock & Cylinder
ELEV36-BLK-H35	*Black*	Hinged	35mm	- Incl. ELEV36 Handle set, 35mm Smart Euro Mortice Lock & Cylinder
ELEV36-BLK-H40	*Black*	Hinged	40mm	- Incl. ELEV36 Handle set, 40mm Smart Euro Mortice Lock & Cylinder
ELEV36-BLK-H45	*Black*	Hinged	45mm	- Incl. ELEV36 Handle set, 45mm Smart Euro Mortice Lock & Cylinder
ELEV36-BLK-H50	*Black*	Hinged	50mm	- Incl. ELEV36 Handle set, 50mm Smart Euro Mortice Lock & Cylinder
ELEV36-BLK-H60	*Black*	Hinged	60mm	- Incl. ELEV36 Handle set, 60mm Smart Euro Mortice Lock & Cylinder
ELEV36-BLK-H65	*Black*	Hinged	65mm	- Incl. ELEV36 Handle set, 65mm Smart Euro Mortice Lock & Cylinder
ELEV36-BLK-H70	*Black*	Hinged	70mm	- Incl. ELEV36 Handle set, 70mm Smart Euro Mortice Lock & Cylinder

'E-Series' SMART DOOR LOCK - (Sliding) *Black*



Art ID	Colour	Door Type	Backset	Description
ELEV36-BLK-S20	*Black*	Sliding	20mm	- Incl. ELEV36 Handle set, 20mm Smart Euro Mortice Lock & Cylinder
ELEV36-BLK-S28	*Black*	Sliding	28mm	- Incl. ELEV36 Handle set, 28mm Smart Euro Mortice Lock & Cylinder
ELEV36-BLK-S35	*Black*	Sliding	35mm	- Incl. ELEV36 Handle set, 35mm Smart Euro Mortice Lock & Cylinder
ELEV36-BLK-S45	*Black*	Sliding	45mm	- Incl. ELEV36 Handle set, 45mm Smart Euro Mortice Lock & Cylinder



ELEV36 SILVER RANGE

'E-Series' SMART DOOR LOCK - (Hinged) *Silver*



Art ID	Colour	Door Type	Backset	Description
ELEV36-SIL-H25	*Silver*	Hinged	25mm	- Incl. ELEV36 Handle set, 25mm Smart Euro Mortice Lock & Cylinder
ELEV36-SIL-H28	*Silver*	Hinged	28mm	- Incl. ELEV36 Handle set, 28mm Smart Euro Mortice Lock & Cylinder
ELEV36-SIL-H30	*Silver*	Hinged	30mm	- Incl. ELEV36 Handle set, 30mm Smart Euro Mortice Lock & Cylinder
ELEV36-SIL-H35	*Silver*	Hinged	35mm	- Incl. ELEV36 Handle set, 35mm Smart Euro Mortice Lock & Cylinder
ELEV36-SIL-H40	*Silver*	Hinged	40mm	- Incl. ELEV36 Handle set, 40mm Smart Euro Mortice Lock & Cylinder
ELEV36-SIL-H45	*Silver*	Hinged	45mm	- Incl. ELEV36 Handle set, 45mm Smart Euro Mortice Lock & Cylinder
ELEV36-SIL-H50	*Silver*	Hinged	50mm	- Incl. ELEV36 Handle set, 50mm Smart Euro Mortice Lock & Cylinder
ELEV36-SIL-H60	*Silver*	Hinged	60mm	- Incl. ELEV36 Handle set, 60mm Smart Euro Mortice Lock & Cylinder
ELEV36-SIL-H65	*Silver*	Hinged	65mm	- Incl. ELEV36 Handle set, 65mm Smart Euro Mortice Lock & Cylinder
ELEV36-SIL-H70	*Silver*	Hinged	70mm	- Incl. ELEV36 Handle set, 70mm Smart Euro Mortice Lock & Cylinder

'E-Series' SMART DOOR LOCK - (Sliding) *Silver*



Art ID	Colour	Door Type	Backset	Description
ELEV36-SIL-S20	*Silver*	Sliding	20mm	- Incl. ELEV36 Handle set, 20mm Smart Euro Mortice Lock & Cylinder
ELEV36-SIL-S28	*Silver*	Sliding	28mm	- Incl. ELEV36 Handle set, 28mm Smart Euro Mortice Lock & Cylinder
ELEV36-SIL-S35	*Silver*	Sliding	35mm	- Incl. ELEV36 Handle set, 35mm Smart Euro Mortice Lock & Cylinder
ELEV36-SIL-S45	*Silver*	Sliding	45mm	- Incl. ELEV36 Handle set, 45mm Smart Euro Mortice Lock & Cylinder



ELEV36 KITS *Hinged Door w/ KNOBS*

'E-Series' SMART DOOR LOCK - (Hinged w/ KNOB) *Silver*



Art ID	Colour	Door Type	Backset	Description
ELEV36-SIL-HK25	*Silver*	Hinged	25mm	- Incl. ELEV36 Handle set, 25mm Smart Euro Mortice Lock & Cylinder
ELEV36-SIL-HK28	*Silver*	Hinged	28mm	- Incl. ELEV36 Handle set, 28mm Smart Euro Mortice Lock & Cylinder
ELEV36-SIL-HK30	*Silver*	Hinged	30mm	- Incl. ELEV36 Handle set, 30mm Smart Euro Mortice Lock & Cylinder
ELEV36-SIL-HK35	*Silver*	Hinged	35mm	- Incl. ELEV36 Handle set, 35mm Smart Euro Mortice Lock & Cylinder
ELEV36-SIL-HK40	*Silver*	Hinged	40mm	- Incl. ELEV36 Handle set, 40mm Smart Euro Mortice Lock & Cylinder
ELEV36-SIL-HK45	*Silver*	Hinged	45mm	- Incl. ELEV36 Handle set, 45mm Smart Euro Mortice Lock & Cylinder
ELEV36-SIL-HK50	*Silver*	Hinged	50mm	- Incl. ELEV36 Handle set, 50mm Smart Euro Mortice Lock & Cylinder
ELEV36-SIL-HK60	*Silver*	Hinged	60mm	- Incl. ELEV36 Handle set, 60mm Smart Euro Mortice Lock & Cylinder
ELEV36-SIL-HK65	*Silver*	Hinged	65mm	- Incl. ELEV36 Handle set, 65mm Smart Euro Mortice Lock & Cylinder
ELEV36-SIL-HK70	*Silver*	Hinged	70mm	- Incl. ELEV36 Handle set, 70mm Smart Euro Mortice Lock & Cylinder

'E-Series' SMART DOOR LOCK - (Hinged w/ KNOB) *Black*



Art ID	Colour	Door Type	Backset	Description
ELEV36-BLK-HK25	*Black*	Hinged	25mm	- Incl. ELEV36 Handle set, 25mm Smart Euro Mortice Lock & Cylinder
ELEV36-BLK-HK28	*Black*	Hinged	28mm	- Incl. ELEV36 Handle set, 28mm Smart Euro Mortice Lock & Cylinder
ELEV36-BLK-HK30	*Black*	Hinged	30mm	- Incl. ELEV36 Handle set, 30mm Smart Euro Mortice Lock & Cylinder
ELEV36-BLK-HK35	*Black*	Hinged	35mm	- Incl. ELEV36 Handle set, 35mm Smart Euro Mortice Lock & Cylinder
ELEV36-BLK-HK40	*Black*	Hinged	40mm	- Incl. ELEV36 Handle set, 40mm Smart Euro Mortice Lock & Cylinder
ELEV36-BLK-HK45	*Black*	Hinged	45mm	- Incl. ELEV36 Handle set, 45mm Smart Euro Mortice Lock & Cylinder
ELEV36-BLK-HK50	*Black*	Hinged	50mm	- Incl. ELEV36 Handle set, 50mm Smart Euro Mortice Lock & Cylinder
ELEV36-BLK-HK60	*Black*	Hinged	60mm	- Incl. ELEV36 Handle set, 60mm Smart Euro Mortice Lock & Cylinder
ELEV36-BLK-HK65	*Black*	Hinged	65mm	- Incl. ELEV36 Handle set, 65mm Smart Euro Mortice Lock & Cylinder
ELEV36-BLK-HK70	*Black*	Hinged	70mm	- Incl. ELEV36 Handle set, 70mm Smart Euro Mortice Lock & Cylinder



'E-Series' REBATE KIT - Suits LOCKTON range of Smart Mortice Locks (Hinged Door)

PRODUCT DESCRIPTION

The LOCKTON SML-H-RBKIT Rebate Kit compliments LOCKTON E-Series ELEV36 Hinged Locksets.

This kit allows Hinged ELEV36 Locksets to be installed in Rebated Doors.

PRODUCT SPECIFICATION

- Suits Common (15mm) Rebates
- Strike Plate Dimensions (H x W x D): 245 x 25 x 15mm
- Lock Plate Dimensions (H x W): 240 x 24mm

Kit Components

- 1 x Strike Plate
- 1 x Lock Plate
- 2 x Fixing Screws



Art ID. SML-H-RBKIT



ELEV36
LW RETROFIT KIT

'E-Series' (Euro Narrow Leverset) SMART DOOR LOCK (LW Retrofit KIT1)

PRODUCT DESCRIPTION

The LOCKTON ELEV36-SIL-H30-LKIT1 (LW Retrofit KIT1) This kit is designed to retrofit over existing installations of 'OPTIMUM & INDURO' Euro mortice locks, while also upgrading from Mechanical to Smartlock.

Kit Components

- 1 x ELEV36 30mm Hinged Smartlock Set (Art. ELEV36-H30)
- 1 x E-Series 'LW' Face Plate (Art. SMLFP210-24-S)



Face Plate

Face Plate Dimensions
(L x W): 210 x 24mm
'Optimum' & 'Induro'
Cut-Out & Face Plate'



Art ID	Description	Colour
ELEV36-SIL-H30-LKIT1	'E-Series' (Euro Narrow Leverset) SMART DOOR LOCK (LW Retrofit KIT1)	SILVER
ELEV36-BLK-H30-LKIT1	'E-Series' (Euro Narrow Leverset) SMART DOOR LOCK (LW Retrofit KIT1)	MATTE BLACK



Smart Door Lock Dealer packages



Art ID. ELEV36-DEAL-PK-B



ELEV36 (BASE) DEALER PKG - Display Stand & 4 x ELEV36 Smart Locks & G2-GATE

Package contains:

- 1 x LOCKTON 'E-Series' ELEV36 Dealer Display Stand, comes fitted with fully functioning ELEV36 Smart Door Lock on a stylish aluminium and timber display mount
- 1 x Art. ELEV36-BLK-H28 'E-Series' Smart Door Lock 28mm Backset (Black)
- 1 x Art. ELEV36-BLK-H30 'E-Series' Smart Door Lock 30mm Backset (Black)
- 1 x Art. ELEV36-SIL-H40 'E-Series' Smart Door Lock 40mm Backset (Silver)
- 1 x Art. ELEV36-SIL-H60 'E-Series' Smart Door Lock 60mm Backset (Silver)
- 1 x Art. G2-GATE 'E-Series' G2 Gateway for connecting ELEV36 to WiFi Network
- 1 x DEALER E-SERIES Promotional Polo Shirt (available in the following sizes: S, M, L, XL, 2XL)



Art ID. ELEV36-DEAL-PK-E



ELEV36 (EXTEND) DEALER PKG - Display Stand & 6 x ELEV36 Smart Locks & G2-GATE

Package contains:

- 1 x LOCKTON 'E-Series' ELEV36 Dealer Display Stand, comes fitted with fully functioning ELEV36 Smart Door Lock on a stylish aluminium and timber display mount
- 1 x Art. ELEV36-BLK-H28 'E-Series' Smart Door Lock 28mm Backset (Black)
- 1 x Art. ELEV36-BLK-H30 'E-Series' Smart Door Lock 30mm Backset (Black)
- 1 x Art. ELEV36-SIL-H40 'E-Series' Smart Door Lock 40mm Backset (Silver)
- 1 x Art. ELEV36-SIL-H60 'E-Series' Smart Door Lock 60mm Backset (Silver)
- 1 x Art. ELEV36-BLK-S28 'E-Series' Smart Door Lock Sliding Door 28mm B/set (Black)
- 1 x Art. ELEV36-SIL-S35 'E-Series' Smart Door Lock Sliding Door 35mm B/set (Silver)
- 1 x Art. G2-GATE 'E-Series' G2 Gateway for connecting ELEV36 to WiFi Network
- 2 x DEALER E-SERIES Promotional Polo Shirt (available in the following sizes: S, M, L, XL, 2XL)





LOCKTON
E-Series



Suitable for use in all heavy traffic areas including:

- Commercial
- Education
- Retail
- Industrial
- Medical



Fingerprint



Digital Password



RFID Tag



6-Pin C4 Key Override



APP



Remote Authorization



Smart Alarm

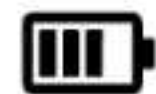

Battery Powered

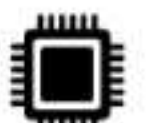

Powerful CPU

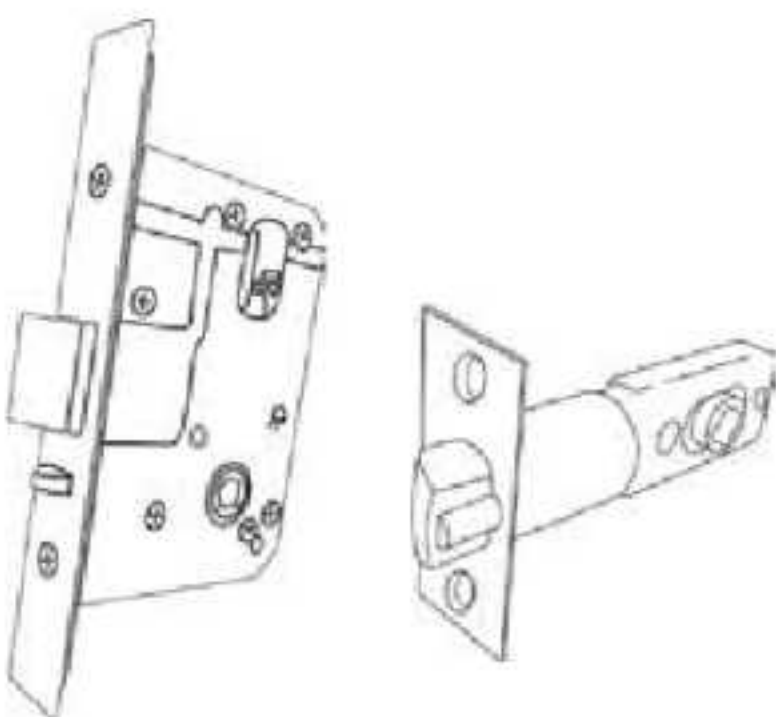

CADELL **52**

Commercial **A**nd **D**omestic **E**lectronic **L**ever **L**ock

NEW

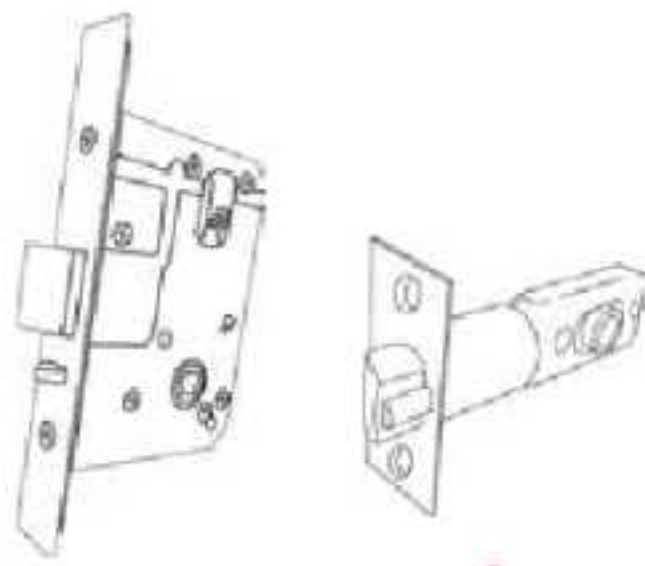

CADELL 52

Commercial And Domestic Electronic Lever Lock



Commercial



“Smart, secure, and built tough —

- A commercial grade Smart Door Lock that retrofits effortlessly to common Australian mortice locks.

Built with weather protection, fire protection and convenience at its core.



- Designed without compromise, the CADELL52 sets a new standard in commercial smart locks — combining superior strength, fire protection, and weather resistance for where it matters most.



2-Hours



SL8 : Physical Security Rating



D8 : Durability Rating (500,000 Cycles)



Design for Access and mobility - AS1428.1-2009



Design & finish

-Every detail of the CADELL52 has been carefully considered to complement common commercial hardware, ensuring a seamless and professional look in any commercial environment.

And....

Australian Registered Design
No. 202512170
Patent Rights Reserved in
Australia & Internationally
AU2025900875

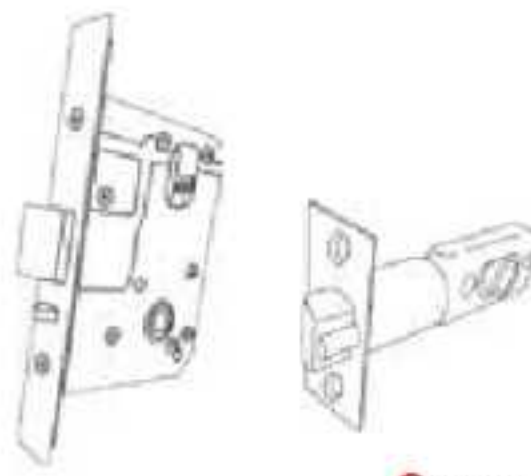

Domestic



'Commercial-Grade Security — for Work or at Home'

- *The CADELL52 Commercial Smart Door Lock is also perfectly suited for residential use — bringing unmatched commercial-grade strength, security, and quality to your home*

'From Knobs to Deadbolts — CADELL 52 — Covers It All'

- *The versatile design of the CADELL52 makes it the perfect upgrade, easily replacing most common knob or lever sets. With its convenient footprint and multiple patch plate options, it can even cover traditional latch-and-deadbolt combinations for a seamless, secure fit!*

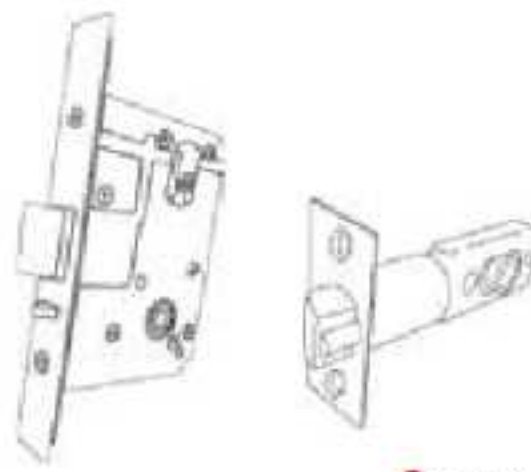

Electronic

'Convenient' 6 Ways to Unlock



Access Specifications

Access methods	Between 20 & 120kgs
Application	TTlock App
IP Rating	IP66
Key Override	6-Pin Australian Oval Cylinder with two keys
Number of users	Unlimited Bluetooth
Key tags (RFID)	1000
Fingerprints	100
PIN Code	Unlimited customised on code on TTlock App
Pin Code Length	4 to 9 digits

LeverLock

General

Door Weight	Between 20 & 120kgs
Application Area	Commercial premises: Apartments Blocks, Schools, Businesses & Private Residences
IP Rating	IP66
Fire Rating	2 Hours
Material thickness (Plate furniture)	2mm Pressed 304 Stainless steel
Finish	Satin Nickel Plate & Matte Black
Handle dimensions	263 x 52 x 22mm (HWD)
Handle Material	Solid Stainless Steel
Door thickness	32-60mm
Batteries	4 x 1.5V AAA alkaline batteries
Battery life	Approximately 1 year (10-20 uses per day)

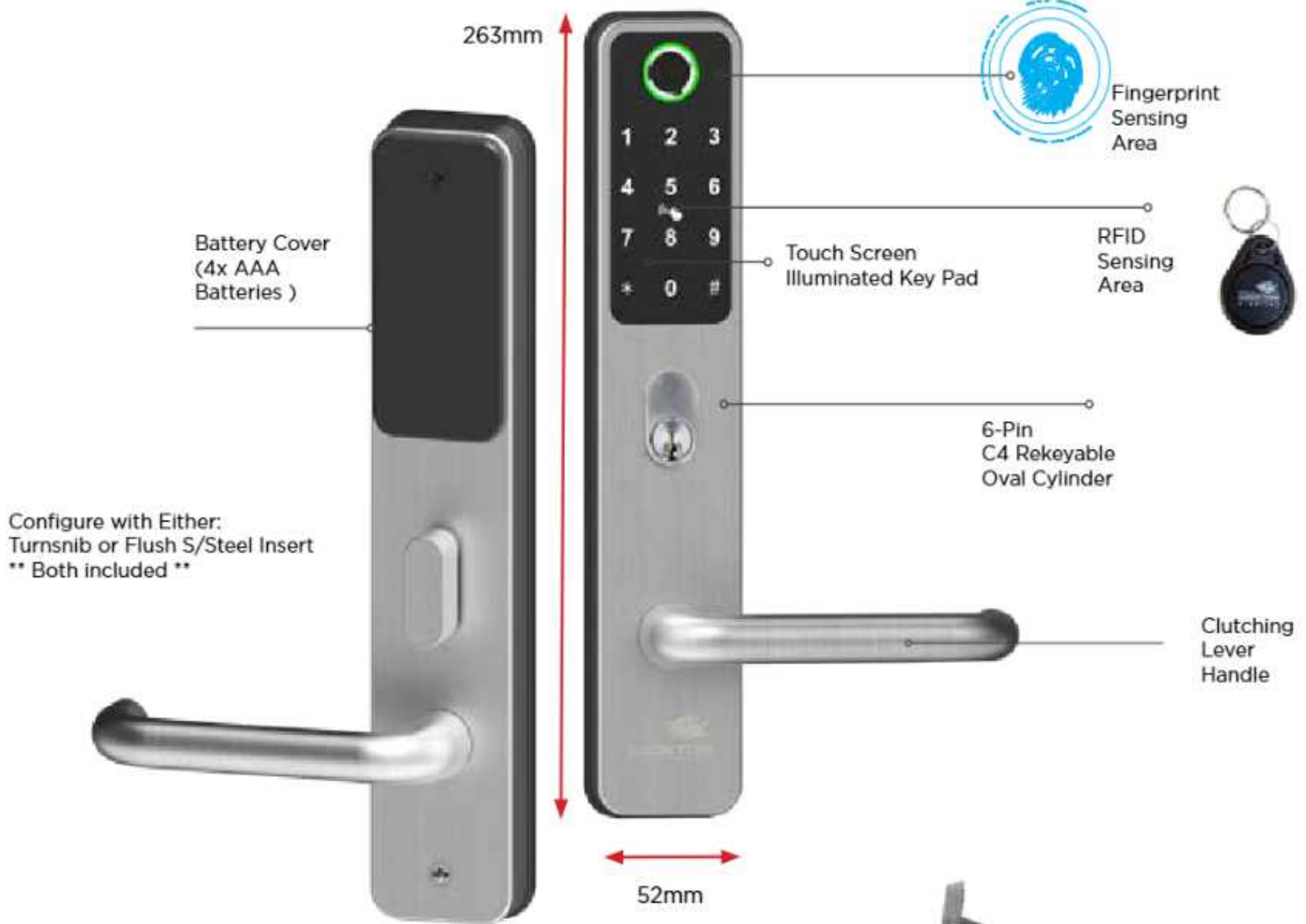

CADELL **52** With - **60mm** Mortice Lock



Art ID	Description
CADELL52-SSS-ML60	'E-Series' CADELL52 Commercial & Domestic Electronic Lever Lock KIT *BLACK* - Incl. 60mm Mortice Lock (Art. SG-ML60)
CADELL52-BLK-ML60	'E-Series' CADELL52 Commercial & Domestic Electronic Lever Lock KIT *BLACK* - Incl. 60mm Mortice Lock (Art. SG-ML60)

CADELL **52** With - **95mm** Mortice Lock



Art ID	Description
CADELL52-SSS-ML95	'E-Series' CADELL52 Commercial & Domestic Electronic Lever Lock KIT *BLACK* - Incl. 95mm Mortice Lock (Art. SG-ML95)
CADELL52-BLK-ML95	'E-Series' CADELL52 Commercial & Domestic Electronic Lever Lock KIT *BLACK* - Incl. 95mm Mortice Lock (Art. SG-ML95)

CADELL **52** Patch Plates

Art ID	Description
PS-REC-52-1-BLK	S/Steel SCAR PLATE (RECTANGLE 280 x 70mm) *Black*
PS-REC-52-1-SS	S/Steel SCAR PLATE (RECTANGLE 280 x 70mm)
PS-REC-52-2-BLK	S/Steel SCAR PLATE (RECTANGLE 286 x 76mm) *Black*
PS-REC-52-2-SS	S/Steel SCAR PLATE (RECTANGLE 286 x 76mm)
PS-REC-52-3-BLK	S/Steel SCAR PLATE (RECTANGLE 296 x 86mm) *Black*
PS-REC-52-3-SS	S/Steel SCAR PLATE (RECTANGLE 296 x 86mm)

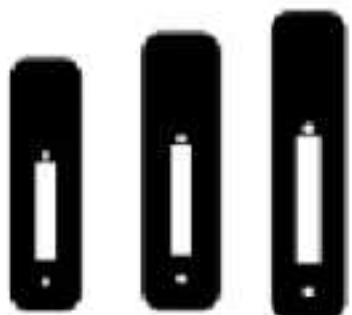



CADELL **52** *IN THE BOX*



CADELL52 Smart Lock Handle Set



2x RFID Key Fobs



Screw / Spindle packs for Door Thickness

- 32-40mm
- 40-50mm
- 50-60mm



Commercial Mortice Lock



Fitting Templates & Instruction Manual



Turnsnib Kit



4x AAA Batteries



6-Pin 'C4' 50mm Oval Cylinder

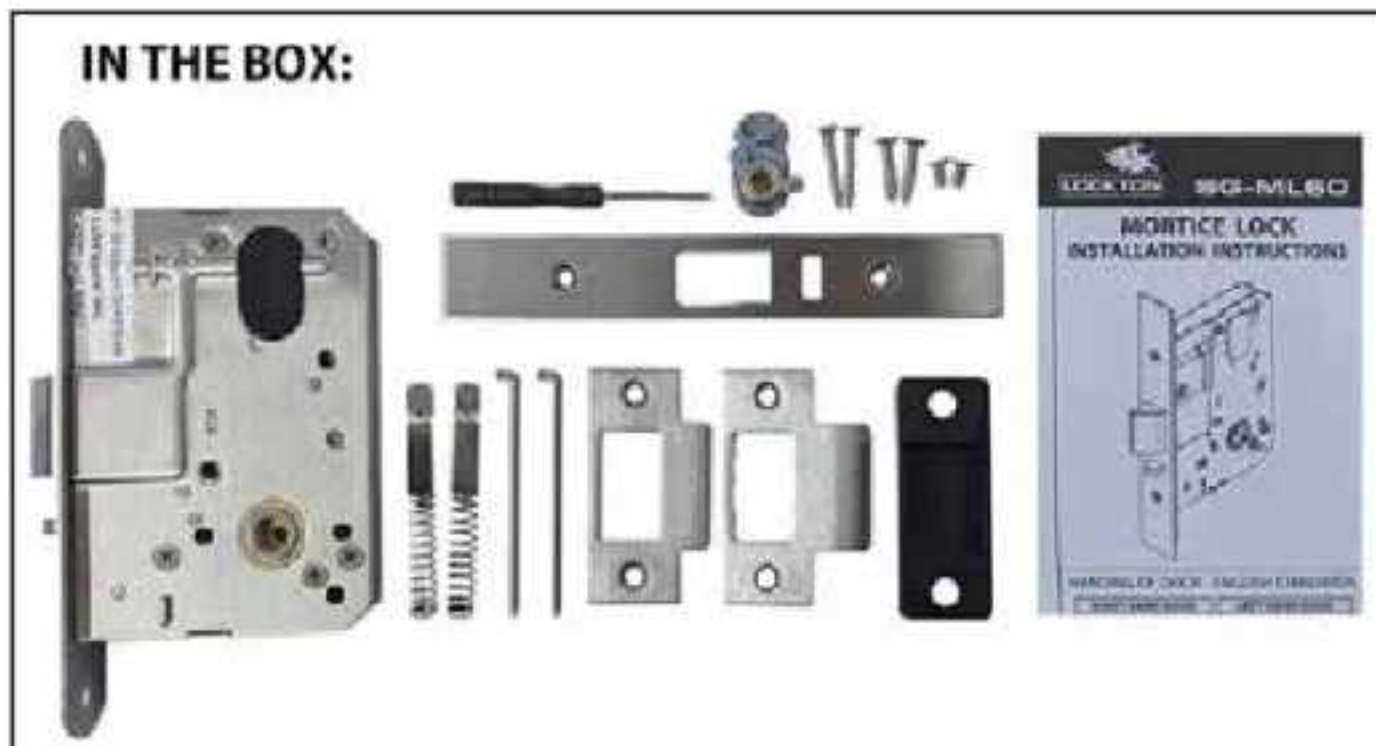



Smart Door Lock

Art. **ELEV64**



Fingerprint



Digital Password



APP



Key



Remote Authorization



Smart Alarm



Battery Powered



Emergency Power Supply



Powerful CPU



Easy Installation

LOCKTON 'E-Series' SMART DOOR LOCK - ELEV64



BLACK Art. ELEV64-BLK



SILVER Art. ELEV64-SIL

PRODUCT DESCRIPTION

LOCKTON 'E-Series' Smart Door Lock supports:

Fingerprints

Digital PIN Codes

Mobile App functionality

Suitable for Domestic and Office applications

Retrofits most residential and commercial

Knobsets and Leversets

Optional G2 Gateway accessory allows for Remote access and control of lock via WiFi

PRODUCT SPECIFICATION

- Finish: Black or Silver
- Suitable door thickness: 35 - 50 mm
- Adjustable 60/70 mm Backset Latch
- Power Supply: 4 x AAA Alkaline Batteries
- Battery Life: Approx. 10,000 openings
- Safe Working Temperature: -20 to 50 Degrees Celsius





Art. ELEV64-DEAL-PKG-2

ELEV64 DEALER PACKAGE - Display Stand & 4 x ELEV64 Smart Locks & G2-GATE

PRODUCT DESCRIPTION

The LOCKTON 'E-Series' ELEV64 DEALER PACKAGE.

Package contains

- 1 x LOCKTON 'E-Series' ELEV64 Dealer Display Stand (with fully functioning ELEV64 Smart Door Lock)
- 2 x Art. ELEV64-SIL 'E-Series' Smart Door Lock (Silver)
- 2 x Art. ELEV64-BLK 'E-Series' Smart Door Lock (Black)
- 1 x Art. G2-GATE 'E-Series' G2 Gateway for connecting ELEV64 to WiFi Network

PRODUCT SPECIFICATION

- Package Size: 6 Piece (as specified above)

Scan to see the ELEV64 DISPLAY PACKAGE



From



Art. PS-REC-TNC-SS
Art. PS-REC-TNC-BLK

LOCKTON - SCAR PLATE (RECTANGLE 225x69mm) - CUT-OUT: Round 54 mm Dia.

PRODUCT DESCRIPTION

This LOCKTON Scar Plate is designed to patch and cover up drill holes and installation points on a variety of domestic entry locksets (see compatibility below).

This plate is also designed to retrofit the LOCKTON Art. ELEV64 to provide a neat and well presented installation.

PRODUCT SPECIFICATION

- Dimensions (L X W X T): 225 x 69 x 1.2 mm
- Hole Cut-out Diameter: 54 mm
- Pack Quantity: 1 x Plate
- Compatibility: Gainsborough Trilock, Lockwood Nexion and Lane Corvan

From

LOCKTON - SCAR PLATE (ROUND 75mm Dia.) - CUT-OUT: Round 54 mm Dia.



Art. PS-RND-75-SS
Art. PS-RND-75-SS-BLK

PRODUCT DESCRIPTION

This LOCKTON Scar Plate is designed to patch and cover-up drill holes and installation points of most domestic/commercial knobsets and leversets.

This plate is also designed to retrofit the LOCKTON Art. ELEV64 to provide a neat and well presented installation.

PRODUCT SPECIFICATION

- Plate Diameter: 75 mm
- Thickness: 1.2 mm
- Hole Cut-Out Diameter: 54 mm
- Pack Quantity: 1 x Plate

From

LOCKTON - SCAR PLATE (ROUND 85mm Dia.) - CUT-OUT: Round 54 mm Dia.



Art. PS-RND-85-SS
Art. PS-RND-85-SS-BLK

PRODUCT DESCRIPTION

This LOCKTON Scar Plate is designed to patch and cover-up drill holes and installation points of most domestic/commercial knobsets and leversets.

This plate is also designed to retrofit the LOCKTON Art. ELEV64 to provide a neat and well presented installation.

PRODUCT SPECIFICATION

- Plate Diameter: 85 mm
- Thickness: 1.2 mm
- Hole Cut-out Diameter: 54 mm
- Pack Quantity: 1 x Plate

From



Hinged Security Screen Doors

The LOCKTON SGHI Hinged Screen Door locks are a great alternative to many other screen door locks on the market and will retro fit existing locks like the MKII. It is a high quality product that comes with all fixing components.



10 YEAR WARRANTY
EVERYDAY LOW PRICE!

Art ID. SGHI-BL



10 YEAR WARRANTY
EVERYDAY LOW PRICE!

Art ID. SGHI-PR



10 YEAR WARRANTY
EVERYDAY LOW PRICE!

Art ID. SGHI-BR

Security Door Closers



10 YEAR WARRANTY
EVERYDAY LOW PRICE!

Art ID. SGHI-WH



Easy Push Catch



Black	White	Primrose
Art. ID SGDC-600-BLK	Art. ID SGDC-600-WHT	Art. ID SGDC-600-PRM

'Premium' Door Closer
EVERYDAY LOW PRICE!



Traditional Hold-open & Release



Black	White	Primrose
Art. ID SGDC-610-BLK	Art. ID SGDC-610-WHT	Art. ID SGDC-610-PRM

'Traditional' Door Closer
EVERYDAY LOW PRICE!



Sliding Security Screen Doors

EVERYDAY LOW PRICE!

The LOCKTON SGSL Sliding Security Screen Door locks are a great alternative to many other screen door locks on the market and will retro fit existing similar style locks. It is a high quality product that comes with all fixing components.



10 YEAR WARRANTY
EVERYDAY LOW PRICE!

Art ID. SGSL-BL



10 YEAR WARRANTY
EVERYDAY LOW PRICE!

Art ID. SGSL-PR



10 YEAR WARRANTY
EVERYDAY LOW PRICE!

Art ID. SGHI-WH

Security Screen Door Cylinders

BOX of 10 - LOCK CYLINDERS - DBL EURO LAZY 5-Pin KAR (KA RANDOM)

EVERYDAY LOW PRICE!

PRODUCT SPECIFICATION

- Chrome Plate finish
- Configuration: KAR (Keyed Alike Random)
- C4 5pin with 2 x keys
- Cylinder Profile: C4 (LW4)
- Also available in KA (Keyed Alike) or KD (Keyed to Differ)
- Quick Re-Key cylinder
- Suitable for screen door locks
- Cylinder Length: 62 mm
- Barrel Length: 31 mm



Art ID. 495-3-CP-KAR





Digital Lock

Art ID. **MDL2100**



Easy Installation



No Batteries Required



Left or Right Handed Door



Press Button Code



Easy Combination Change



8000 Code Combinations



Holdback Option (Lock Latch Open)

LOCKTON 'Essentials' MECHANICAL DIGITAL LOCK - with Hold Back Function

PRODUCT DESCRIPTION



- LOCKTON 'Essentials' Mechanical Digital Lock designed for access control in Domestic and low traffic Commercial spaces.
- Designed to retrofit over most existing Digital Locks on the market
- Suitable for left and right handed doors.
- Ease of installation with no batteries required.
- Code change is quick and easy to achieve
- Simple and ergonomic push button design.
- Internal lever set to always open for ease of egress.
- Holdback function allows the latch to be held in the open position if required for ease of egress.
- Comes supplied with 60 mm backset Deadlatch.
- Optional 70 mm backset Deadlatches also available.

PRODUCT SPECIFICATION

- Finish: Satin Chrome
- Suits Door Thickness: 35 - 50 mm
- Number of Code Combinations: 8,000





Key Tag Containers



Art ID. KTID5-D140

KEY TAG BARREL - 140 KEY TAGS

PRODUCT DESCRIPTION

- Round & Clear Plastic Barrel
- 140 x Key Tags Assorted Colours

PRODUCT SPECIFICATION:

- KEY TAG = 54 mm x 28 mm
- SPLIT RING = 25 mm Diameter
- 20 x White
- 20 x Blue
- 20 x Yellow
- 20 x Green
- 20 x Orange
- 20 x Purple
- 20 x Red



Art ID. KTID5-D175

KEY TAG JAR - 175 KEY TAGS

PRODUCT DESCRIPTION

- Cylindrical & Clear Plastic Jar
- 175 x Key Tags Assorted Colours

PRODUCT SPECIFICATION:

- KEY TAG = 54 mm x 28 mm
- SPLIT RING = 25 mm Diameter
- 25 x White
- 25 x Blue
- 25 x Yellow
- 25 x Green
- 25 x Orange
- 25 x Purple
- 25 x Red



Art ID. KTID5-D420

KEY TAG HOPPER *PERSPEX* - 420 KEY TAGS

PRODUCT DESCRIPTION

- Large Clear Perspex Hopper
- Hopper Dimensions (H x D x W) : 310 x 180 x 200 mm
- Eye Catching Display
- Hopper Holds 210 Tags
- Supplied with 420 Tags Total

PRODUCT SPECIFICATION:

- KEY TAG = 54 mm x 28 mm
- SPLIT RING = 25 mm Diameter
- 60 x White
- 60 x Blue
- 60 x Yellow
- 60 x Green
- 60 x Orange
- 60 x Purple
- 60 x Red

Key Tag Refills



KEY TAGS INDIVIDUAL COLOUR - Pkt of 20

PRODUCT DESCRIPTION

- See-Through Coloured Plastic
- Individual colour
- Packet of 20

PRODUCT SPECIFICATION:

- KEY TAG = 54 mm x 28 mm
- SPLIT RING = 25 mm Diameter

Blue	Green	Orange	Purple
Art. KTID5-BL	Art. KTID5-GN	Art. KTID5-OR	Art. KTID5-PU
Red	Yellow	White	
Art. KTID5-RD	Art. KTID5-YE	Art. KTID5-WH	



Art ID. KTID5-RF70

KEY TAG REFILL - Asst. Colours - 70 KEY TAGS

PRODUCT DESCRIPTION

- Refill Pack for LOCKTON Key Tag Displays
- 70 x Key Tags Assorted Colours

PRODUCT SPECIFICATION:

- KEY TAG = 54 mm x 28 mm
- SPLIT RING = 25 mm Diameter
- 10 x White
- 10 x Blue
- 10 x Yellow
- 10 x Green
- 10 x Orange
- 10 x Purple
- 10 x Red



Art ID. KTID5-RF175

KEY TAG REFILL - Asst. Colours - 175 KEY TAGS

PRODUCT DESCRIPTION

- Refill Pack for LOCKTON Key Tag Displays
- 175 x Key Tags Assorted Colours

PRODUCT SPECIFICATION:

- KEY TAG = 54 mm x 28 mm
- SPLIT RING = 25mm Diameter
- 25 x White
- 25 x Blue
- 25 x Yellow
- 25 x Green
- 25 x Orange
- 25 x Purple
- 25 x Red



ESSENTIALS DOOR STOPPER

DISC



Form &
Function



Anti-Slip



Wooden
Surfaces



Tiled
Surfaces

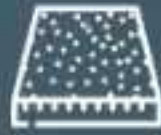

Carpet
Surfaces

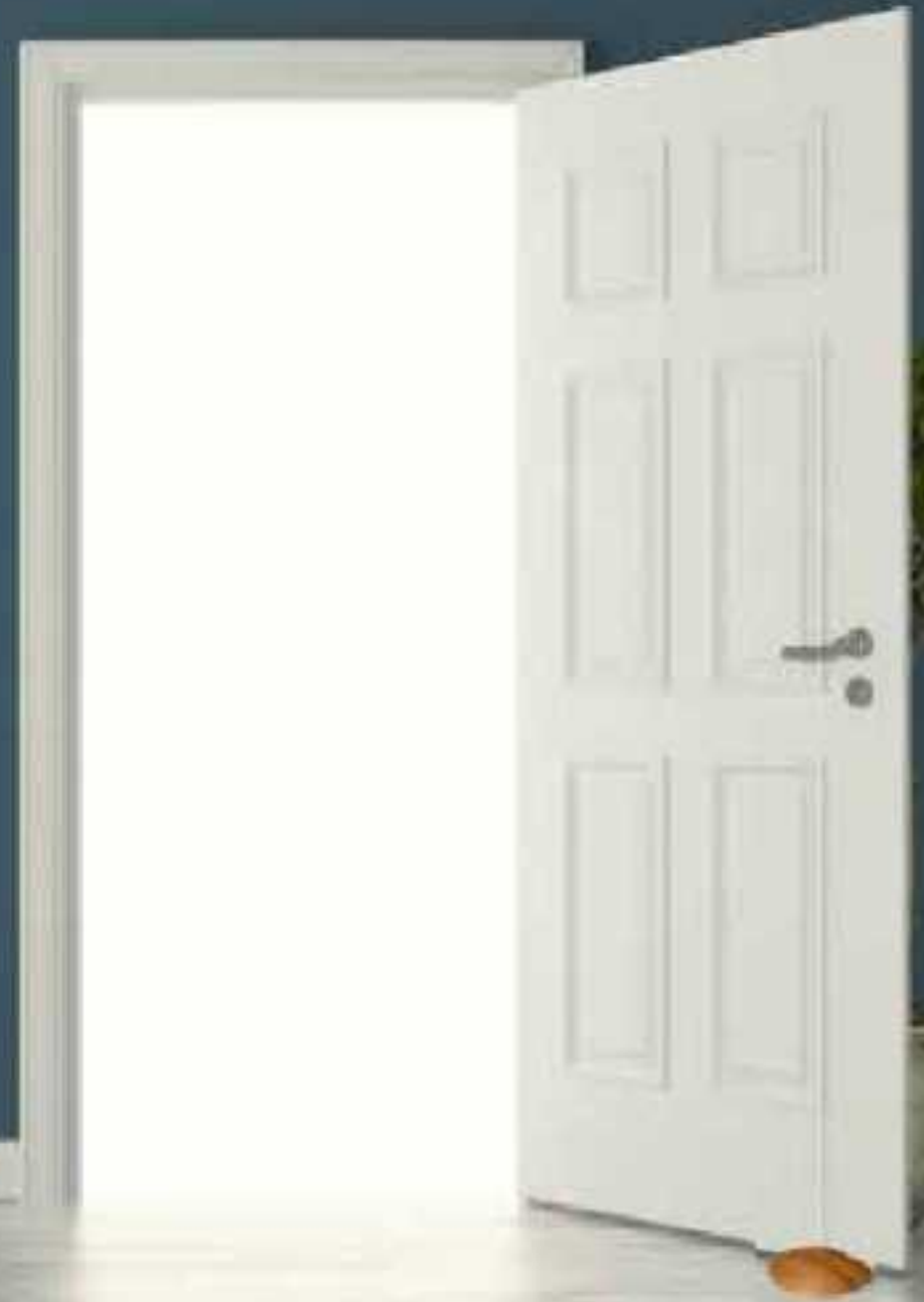

Wooden
Surfaces

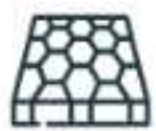

Tiled
Surfaces



Carpet
Surfaces





'Essentials' DOOR STOPPERS (Form & Function) Anti-Slip on Wood, Tiles & Carpet

PRODUCT DESCRIPTION

High quality modern design suitable for use at home or office and available in multiple finishes.

Unique disc shape that is both easy to correctly position & relocate unlike traditional door stops and wedges.

Environmentally friendly but also non-harmful to children and pets.

Door stop also comes fitted with a patented adhesive neoprene anti-slip base that is extremely resistant to movement on multiple surfaces including timber, carpet and tiles.



Art ID. DS132

PRODUCT SPECIFICATION

- Diameter: 135mm
- Height: 28mm

WOOD GRAIN COLLECTION



Cherry
Art ID. DS132-WGC

Ebony
Art ID. DS132-WGE

Oak
Art ID. DS132-WGO

Walnut
Art ID. DS132-WGW

VIBRANT COLOUR COLLECTION

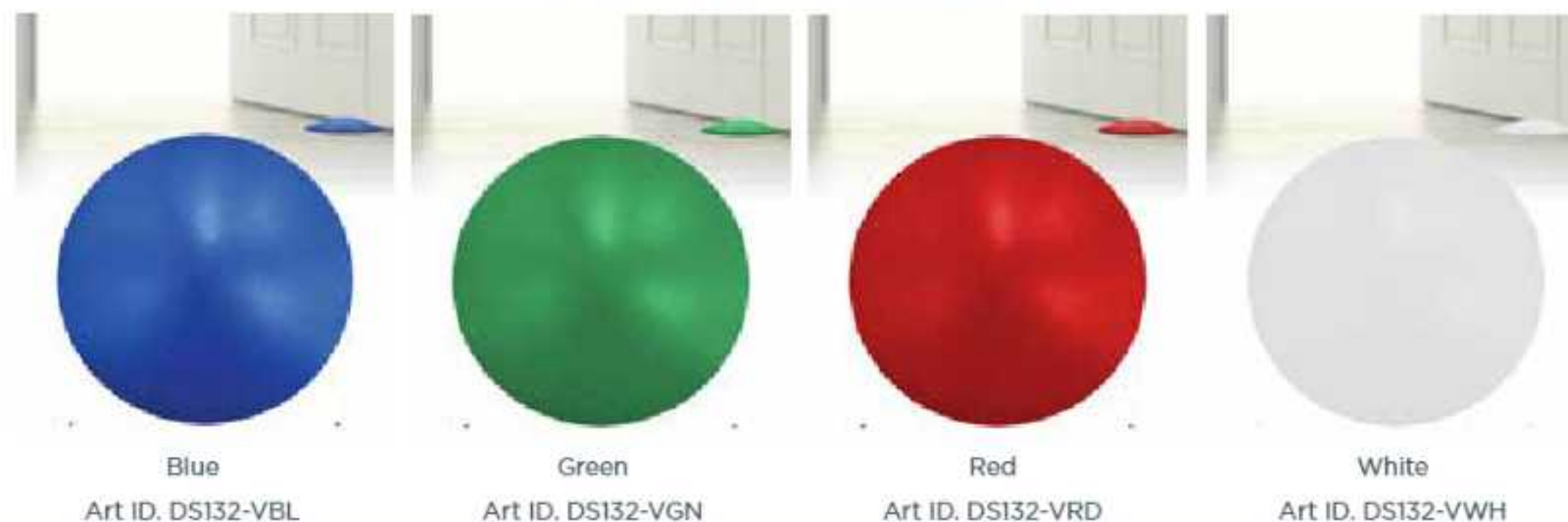

Blue
Art ID. DS132-VBL

Green
Art ID. DS132-VGN

Red
Art ID. DS132-VRD

White
Art ID. DS132-VWH

'Essentials' Door Stopper COUNTER DISPLAY *24 pieces* - 4 x Wood ; 4 x Colour (3 of each)

PRODUCT DESCRIPTION

LOCKTON Door Stoppers Counter Top Display Stand 24 Pack

This colourful and eye-popping display is a great option for a front counter or similar surface in a shop front.

The unit comes stocked with 3 x of each Door Stopper model making it a great demonstrator for the entire range.

PRODUCT SPECIFICATION

- Dimensions (H x W x D): 310 x 370 x 360mm
- Height: 28mm

Art ID: **DS132-DISP24**

