



# StarNet – ADA24



24x24 A/D D/A Line Level to Dante Audio Interface

User Manual

Issue 1

527-420

## Health & Safety Notice

---

**FOR YOUR OWN SAFETY AND FOR THE PROTECTION OF OTHERS  
PLEASE OBSERVE THE FOLLOWING HEALTH AND SAFETY INSTRUCTIONS**



- READ THESE INSTRUCTIONS AND KEEP THEM HANDY
- HEED ALL SAFETY WARNINGS
- DO NOT USE NEAR WATER
- CLEAN ONLY WITH A DRY CLOTH
- DO NOT INSTALL NEAR HEAT SOURCES
- DO NOT BLOCK VENTILATION OPENINGS
- PROTECT THE POWER CORD
- USE ONLY ACCESSORIES SPECIFIED BY THE MANUFACTURER
- UNPLUG WHEN UNUSED FOR LONG PERIODS
- OPTIONAL CARDS SHOULD NOT BE INSERTED OR REMOVED WITH THE POWER ON
- REFER ALL SERVICING TO QUALIFIED PERSONNEL ONLY
- NO USER-SERVICEABLE PARTS INSIDE

**FAILURE TO OBSERVE THESE PROCEDURES AND RECOMMENDATIONS  
WILL INVALIDATE THE MANUFACTURER'S WARRANTY**



## Avertissements de Santé & Sécurité

---

**POUR VOTRE SECURITE ET CELLE DES AUTRES MERCI DE RESPECTER LES INSTRUCTIONS DE SANTE ET SECURITE SUIVANTES**



- LISEZ CES INSTRUCTIONS ET GARDEZ-LES À PORTÉE DE MAIN
- TENEZ COMPTE DE TOUS LES AVERTISSEMENTS DE SÉCURITÉ
- NE PAS UTILISER PRÈS D'UNE SOURCE D'EAU
- NETTOYER UNIQUEMENT AVEC UN CHIFFON SEC
- NE PAS INSTALLER PRÈS D'UNE SOURCE DE CHALEUR
- NE PAS BLOQUER LES BOUCHES D'AÉRATION
- PROTÉGER LE CORDON D'ALIMENTATION
- N'UTILISER QUE LES ACCESSOIRES SPÉCIFIÉS PAR LE FABRICANT
- DÉBRANCHER PENDANT DE LONGUES PÉRIODES D'INACTIVITÉ
- NE PAS INSÉRER OU RETIRER D'ÉVENTUELLES CARTES OPTIONNELLES ALORS QUE L'APPAREIL EST SOUS TENSION
- CONFIER TOUTES LES OPÉRATIONS DE MAINTENANCE À DU PERSONNEL QUALIFIÉ UNIQUEMENT
- AUCUNE PIÈCE INTERNE N'EST RÉPARABLE PAR L'UTILISATEUR

**LE NON-RESPECT DE CES PROCÉDURES ET RECOMMANDATIONS INVALIDERA LA GARANTIE DU FABRICANT**



# Important Safety Instructions

For your own safety and for the protection of others, please observe the following safety precautions:

- 1) Read these instructions.
- 2) Keep these instructions.
- 3) Heed all warnings.
- 4) Follow all instructions.
- 5) **WARNING: To reduce the risk of fire or electric shock, do not expose this apparatus to rain or moisture**
- 6) Clean only with dry cloth.
- 7) Do not block any ventilation openings.
- 8) Do not install near any heat sources such as radiators, heat registers, stoves, or other apparatus (including amplifiers) that produce heat.
- 9) Protect the power cord from being walked on or pinched particularly at plugs, convenience receptacles, and the point where they exit from the apparatus.
- 10) Unplug this apparatus during lightning storms or when unused for long periods of time.
- 11) Refer all servicing to qualified service personnel. Servicing is required when the apparatus has been damaged in any way, such as when liquid has been spilled or objects have fallen into the apparatus, the apparatus has been exposed to rain or moisture, does not operate normally, or has been dropped.

**WARNING:**

**TO REDUCE THE RISK OF FIRE OR ELECTRIC SHOCK, DO NOT EXPOSE THIS APPARATUS TO RAIN OR MOISTURE.**

**WARNING:**

**THIS APPARATUS HAS CLASS I CONSTRUCTION AND SHALL BE CONNECTED TO THE EXTERNAL PSU MAINS SOCKET OUTLET WITH A PROTECTIVE EARTHING CONNECTION.**

**WARNING:**

**WHERE THE MAINS PLUG OR AN APPLIANCE COUPLER IS USED AS THE DISCONNECT DEVICE, THE DISCONNECT DEVICE SHALL REMAIN READILY OPERABLE.**

*Head Office:*  
**AMS Neve**  
Billington Road  
Burnley  
Lancashire  
England  
BB11 5UB

Phone: +44 (0) 1282 457 011

Fax: +44 (0) 1282 417 282

Email: [Info@ams-neve.com](mailto:Info@ams-neve.com)

Web: [www.ams-neve.com](http://www.ams-neve.com)

---

© © 2005 - 2026 AMS Neve Ltd own the copyright of all information and figures contained in this manual which are not to be copied or reproduced by any means or disclosed in part or whole to any third party without written permission. As part of our policy of continual product improvement, we reserve the right to alter specifications without notice but with due regard to all current legislation.

**Disclaimer:** The information in this manual has been carefully checked and is believed to be accurate at the time of publication. However, no responsibility is taken by AMS-Neve for inaccuracies, errors or omissions nor any liability assumed for any loss or damage resulting either directly or indirectly from use of the information contained within.

**Trademarks:** Neve®, 1073® and Marinair® are registered trademarks. AMS Neve Limited pursues a policy of continual improvement therefore all specifications are subject to change without notice. All trademarks are property of their respective owners E & O E ©2026 AMS Neve Ltd.

---

# Instructions Importantes sur la Sécurité:

Pour votre sécurité et celle des autres merci de respecter les instructions de santé et sécurité suivantes :

- 1) Lisez ces instructions.
- 2) Gardez ces instructions.
- 3) Tenez compte de tous les avertissements.
- 4) Suivez toutes les instructions.
- 5) **ATTENTION:** afin de réduire les risques d'incendie ou de choc électrique, n'exposez pas cet appareil à la pluie ou à l'humidité
- 6) Nettoyez uniquement avec un chiffon sec
- 7) Ne pas bloquer les bouches d'aération
- 8) Ne pas installer à proximité d'une source de chaleur telle qu'un radiateur, une bouche d'air chaud, des plaques de cuisson (ou cuisinière), ou n'importe quel autre appareil producteur de chaleur (y compris un amplificateur)
- 9) Protégez le cordon d'alimentation afin d'éviter les piétinements et pincements, et plus particulièrement à proximité des prises de courant ou tout autre élément de branchement, ainsi qu'au point de sortie de l'appareil)
- 10) Débranchez cet appareil pendant les orages ou de longues périodes d'inactivité.
- 11) Confiez toutes les opérations de maintenance à un technicien qualifié. Un entretien est nécessaire lorsque l'appareil a été endommagé de quelque manière que ce soit, comme par exemple si le cordon d'alimentation ou la fiche sont endommagés, du liquide a été renversé ou des objets sont tombés dans l'appareil, si l'appareil a été exposé à la pluie ou à l'humidité, s'il ne fonctionne pas correctement ou a subi une chute de hauteur.

## **ATTENTION:**

**AFIN DE RÉDUIRE LES RISQUES D'INCENDIE OU DE CHOC ÉLECTRIQUE, N'EXPOSEZ PAS CET APPAREIL À LA PLUIE OU À L'HUMIDITÉ.**

## **ATTENTION:**

**CET APPAREIL CORRESPOND A UNE CONSTRUCTION DE CLASSE I ET DOIT ÊTRE RACCORDÉ À UNE PRISE SECTEUR DOTÉE D'UNE PROTECTION PAR MISE À LA TERRE.**

## **ATTENTION:**

**LORSQU'UNE PRISE SECTEUR OU UN PROLONGATEUR EST UTILISÉ COMME DISPOSITIF DE DÉBRANCHEMENT, CELUI-CI DOIT RESTER FACILEMENT ACCESSIBLE.**



# Table of Contents

Health & Safety notice.....	2
Health & safety notice (French).....	3
Important Safety Instructions .....	4
Important Safety Instructions (French) .....	5
StarNet ADA24 Introduction .....	7
Rackmount Instructions .....	8
Rackmount Instructions (French) .....	8
Configuring the StarNet ADA24 .....	9
Front Panel Controls.....	10
Rear Panel Connections.....	13
Ethernet Connections.....	14
Dante Audio-Over-IP .....	15
Dante Network Connections .....	16
Dante Controller .....	17
Firmware Updater .....	22
StarNet ADA24 Remote App.....	28
Troubleshooting .....	30
Dimensions and Power Requirements .....	31
Audio Specification .....	32
A/D Input Specification.....	32
D/A Output Specification.....	32
Unit Connection Tables .....	33
Line Input 25-Way D-Type Pin outs .....	33
Line Output 25-Way D-Type Pin outs .....	34
Line Output 25-Way D-Type Pin outs .....	35



## StarNet ADA24 Introduction



The StarNet ADA24 is Neve's first 24x24 analogue line-level AD/DA converter to the Dante audio-over-IP network. Housed in a 2U 19" rack chassis, the ADA24 is a compact, professional unit suited for integration into a wide range of recording studios, live sound venues, and broadcast or post-production suites.

The StarNet ADA24's is capable of up to 192kHz sample frequency and 32-bit integer bandwidth, with mastering-grade A/D converters producing 119dBFS of dynamic range, and pristine quality D/A converters producing 122dBFS of dynamic range. The ADA24 features a selectable headroom of +18, 24 or 26dBu to accommodate any digital standard. Analogue I/O is provided via four rear-panel DB25 connectors for simple connection to professional analogue equipment and studio patch bays.

The Neve StarNet ADA24 uses a modern, low-drift crystal oscillator clocking system and PLL complimented with DAC chips featuring built-in jitter elimination, this system makes the ADA24 the ideal master clock in any professional studio environment. Devices can synchronise to the ADA24 master clock via a 75 Ohm BNC word clock output, and the StarNet ADA24 can synchronise with external equipment via a 75 Ohm BNC word clock input connection.

The ADA24's analogue output stage uses the same balanced line amplification technology from the 88R console. This circuitry delivers an analogue frequency bandwidth that surpasses 100kHz, the perfect platform to translate true 192kHz digital audio. This amplification stage is incredibly stable, able to drive long cable lengths without signal degradation. The analogue input stage is complimented with similar technology, professionally balanced, with superb common mode rejection and pristine audio quality.

Dante connections are provided by dual Ethernet ports on the rear of the unit - labelled Primary and Secondary. This redundant system provides reliability in case of network failure. Alternatively, the Secondary port can be used to daisy-chain multiple units together when operating in switched mode.

The front-mounted OLED screen displays at-a-glance network settings, sample rate, bit depth, Pull-Up/Down, headroom, clock source, meter settings and comms IP settings. Simple menu navigation buttons are fitted either side of the OLED screen, and input/output LEDs display signal and clip information for all 24 analogue inputs & outputs.

The ADA24 analogue outputs can be remotely cut and attenuated via Neve's ADA24 remote app. This system allows for complete control over all analogue outputs on the network providing piece of mind that any connected analogue gear is protected from audio spikes.

The unit's external PSU and internal fan cooling system keeps unwanted heat away from the internal components of the StarNet ADA24, protecting them from heat damage and offering a long lifespan of any StarNet ADA24 unit.

## Rack Mount Instructions

- ▶ Elevated Operating Ambient- If installed in a closed or multi-unit rack assembly, the operating ambient temperature of the rack environment may be greater than room ambient. Therefore, consideration should be given to installing the equipment in an environment compatible with the maximum ambient temperature (30°C) specified by the manufacturer.
- ▶ Reduced Air Flow - Installation of the equipment in a rack should be such that the amount of airflow required for safe operation of the equipment is not compromised.
- ▶ Mechanical Loading - The mounting of the equipment in the rack should be such that a hazardous condition is not created by improper or uneven mechanical loading.
- ▶ Reliable Earthing - Reliable earthing of rack-mounted equipment should be maintained. Particular attention should be given to supply connections other than direct connections to the branch circuit (e.g. use of power strips).

## Installation en Baie (rack)

- ▶ Température en service élevée – si l'installation est effectuée dans un endroit clos et/ou multi-rack, il se peut que la température localisée soit plus élevée que la température ambiante. Dans ce cas, il faudra faire attention à ce que l'environnement soit compatible avec la température ambiante maximale (30°) spécifiée par le fabricant.
- ▶ Aération réduite – l'installation de l'appareil dans une baie devra être réalisée afin de permettre une circulation d'air suffisante pour que le fonctionnement de celui-ci ne soit pas compromis.
- ▶ Installation mécanique – l'installation de l'appareil dans un rack devra être réalisée afin d'éviter une position qui s'avèrerait dangereuse dans le cas d'une installation instable.
- ▶ Mise à la terre convenable – la mise à la terre dans le cas d'une installation en baie/rack doit être maintenue. Une attention particulière devra être portée pour toute connection indirecte (par exemple utilisation d'une multiprise).

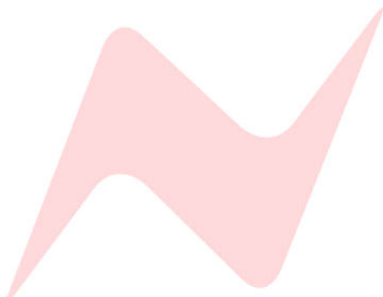

**To operate the StarNet ADA24, configure as follows:**

- ▶ Ensure unit is switched off by depressing the front ON switch.
- ▶ Connect the PSU to the mains supply.
- ▶ Connect the supplied power adaptor (PS12221) to the rear 5-pin DIN input.
- ▶ Connect your line input source/s to the rear unit D-sub connectors. These inputs follow the DB-25 standard pin configuration.
- ▶ Connect the line output/s to the rear unit D-sub connector. These outputs follow the DB-25 standard pin configuration.
- ▶ Connect the Primary network port to the Dante network by using either a CAT5e or CAT6 Ethernet cable.
- ▶ Connect the Secondary network port to the Dante network by using either a CAT5e or CAT6 Ethernet cable if required.
- ▶ Switch on the unit; it will default to the last-used setting. Adjust front headroom and meter controls as required.
- ▶ Open Dante Controller on the computer connected to the Dante network to configure the unit's sample rate, bit depth, etc.

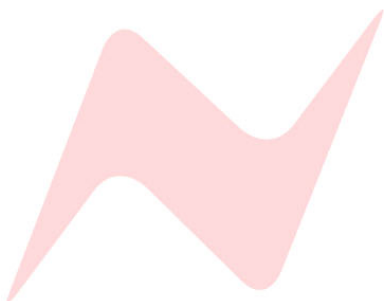

## Front Panel



### Front Panel Controls



**POWER:** Switches the unit on or off. The button will light red when the unit is powered ON.

**Input Meters:** Each input channel has an LED meter that illuminates to display analogue signal entering the device with a digital clipping warning. The meters are taken from the ADC, providing DBFS scale metering, ideal for levelling signal into digital audio workstations.

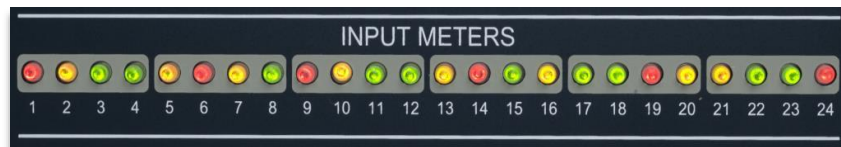

#### Input LED Colours-

- ▶ **Green** to display analogue signal at levels of -50dBFS or higher.
- ▶ **Amber** to display -6dBFS below digital clipping.
- ▶ **Red** to indicate digital clipping above -0.6dBFS.

**Output Meters:** Each output channel has an LED meter that illuminates to display analogue signal leaving the device and show digital clipping.

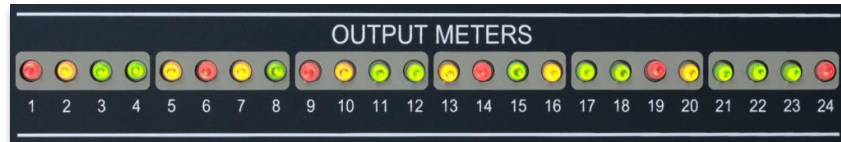

#### Output LED Colours-

- ▶ **Green** to display analogue signal at levels of -50dBFS or higher.
- ▶ **Amber** to display -6dBFS below digital clipping.
- ▶ **Red** to indicate digital clipping above -0.6dBFS.

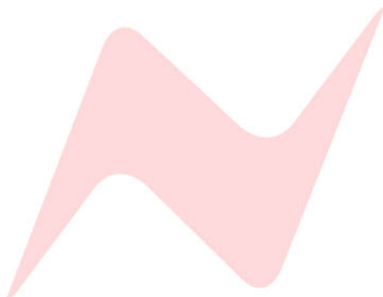

## OLED Display

---

The OLED display mounted on the unit front panel is used to display Dante network settings, Sample Rate, Internal/External Clock settings, encoding settings and additional front panel controls set using the menu buttons.

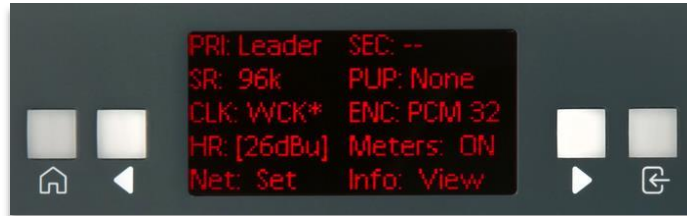

## Front Panel Adjustable Settings

---

The following settings are adjusted via the front panel controls:

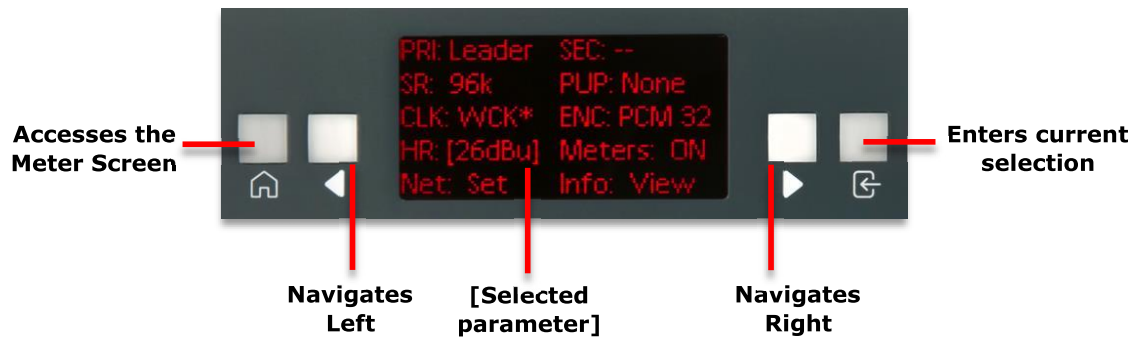

**HR: 26dBu**

**HR:** adjusts the unit's analogue output headroom fed from the AD converter.

### Headroom settings-

- ▶ 18dBu – EBU standard
- ▶ 24dBu – US standard
- ▶ 26dBu – SMPTE standard

**Meters: ON**

**Meters: ON/OFF** toggles the front display LED Input and Output metering on or off

**Net: Set**

**Net: Set** enters Ip config window

See [Firmware Updater](#) for more information.

**Info: View**

**Info: View** Enters

## [Dante Information Window](#)

### OLED I/O Metering

The StarNet ADA24 has an additional metering feature that uses the OLED display to show 24 incoming analogue inputs and 24 outgoing analogue outputs.

The OLED I/O metering is accessed by pressing the  Button.

**Input Meters** are selected via the  button.

**Output Meters** are selected via the  button.

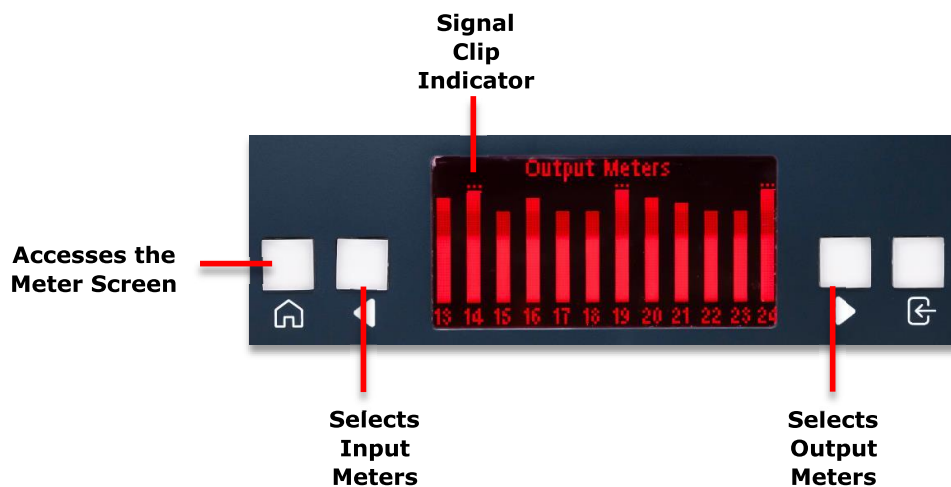

### OLED Screensaver

The OLED display will default to a Screensaver mode if not in use after 30 minutes. The display will go blank and the Home button will be lit. Pressing the Home button will exit Screensaver mode.

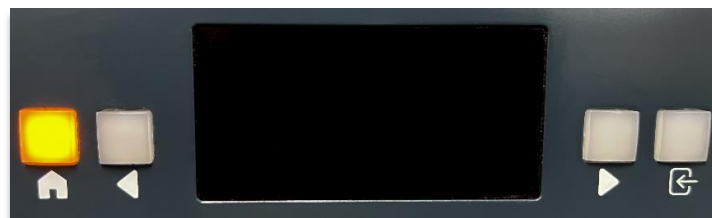

## Rear Panel



**DC IN:** 5 pin DIN power inlet for the power supply.

**CHASSIS:** Provides a physical connection for the technical earth circuit.

**TECH EARTH:** Activates the technical earth circuit to the chassis connection.

**COMMS:** Ethernet port for communication data and firmware updates.

**SOFT:** Soft keys are reserved for future firmware update.

**PRIMARY:** RJ-45 Connector for Cat5/6 Ethernet port to connect to the primary Dante Audio-over-IP Network.

**SECONDARY:** RJ-45 Connector for Cat5/6 Ethernet port to connect to the secondary Dante Audio-over-IP Network.

**WCLK I/P:** Word Clock 75Ω BNC input.

**WCLK O/P:** Word Clock 75Ω BNC output.

**ANALOGUE INPUTS 1-8, 9-16, 17-24:** 25-pin D-type connector for analogue line inputs 1 to 8, 9 to 16 and 17-24.

**ANALOGUE OUTPUTS 1-8, 9-16, 17-24:** 25-pin D-type connector for analogue line outputs 1 to 8, 9 to 16 and 17-24.

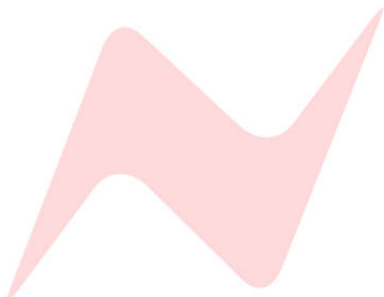

## Ethernet Connections

To connect the StarNet ADA24 to the Dante Network using either the Primary or Secondary network port an RJ-45 connector type with CAT5e or CAT6 Ethernet cable must be used.

**Caution: The Unit must be connected via a Gigabit Ethernet switching hub.**

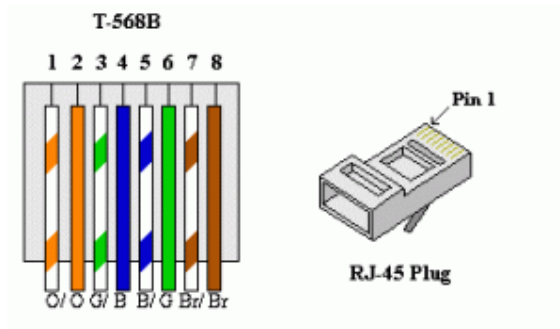

Pin	CAT6 Core
1	Orange + White
2	Orange
3	Green + White
4	Blue
5	Blue + White
6	Green
7	Brown + White
8	Brown



Dante is a complete, audio-over-IP networking solution developed by Audinate and supported by pro audio manufacturers. Dante enables digital audio distribution via standard Ethernet networks — the same networks used for home or office data networking.

The StarNet ADA24 is a Dante-enabled networked audio device visible and controllable from the Dante network.

Line-level analogue inputs will be converted to digital signals within the unit to send to many other devices over the Dante Audio-over-IP network.

Digital signals sent to the device over the Dante audio-over-IP network will be converted to analogue line-level via the unit's D-sub output connectors to any analogue line-level device.

The **PRIMARY** or **SECONDARY** Dante ports must be connected via a CAT5 or CAT6 cable to the Dante network to use the StarNet ADA24 as a Dante-enabled audio device.

Once the connection is made, **PRI** or **SEC** status on the OLED display will show as **Leader** or **Follower** depending on Dante controllers preferred master settings, this indicates a valid Dante connection.



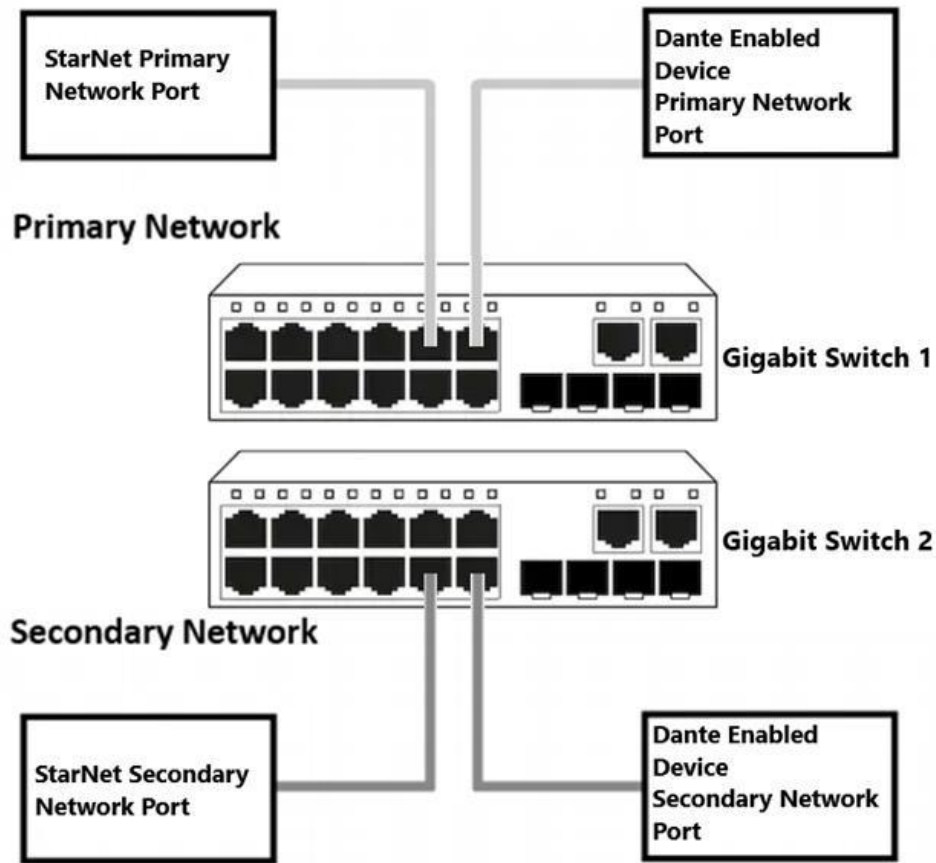

The StarNet ADA24 has both a **PRIMARY** Dante network port and a redundant **SECONDARY** Dante network port.

The Primary network port connects to the primary Dante network along with your Dante Controller-enabled Mac/PC. Additional Dante devices are also connected to this network and will appear as available transmitters or receivers in the Dante Controller routing matrix. Subscriptions from the StarNet ADA24 can be made to any other known device via Dante Controller.

The secondary Dante network port is used to create a redundant Dante network and provides a failsafe Dante connection should the primary network fail. The secondary network connection must be made using a separate gigabit Ethernet switch.

***All Dante connections should be made using CAT5e or CAT6 Ethernet cable and connections must be made by using gigabit switches.***

***For more information on Dante Networked audio please visit [www.audinate.com](http://www.audinate.com)***

The Dante Controller software allows users to route any of the StarNet ADA24 audio paths to any available network audio device via the simple routing matrix on the main screen.

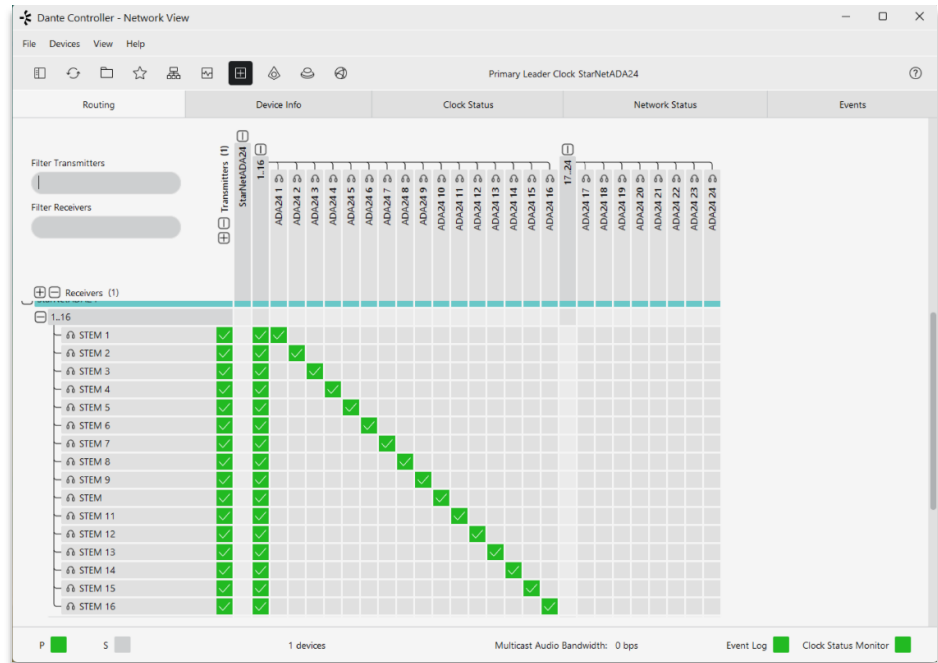



This window uses horizontal and vertical tabs to make audio connections between units visible on the Dante network. Active connections are called subscriptions.

The horizontal tab shows 'Transmitters'. These are digital audio outputs from your units, and the StarNet ADA24 has 24 available transmitters.

The vertical tab shows 'Receivers', and these are digital audio inputs into your units. The StarNet ADA24 has 24 available receivers.

## Making Connections

Connections (subscriptions) are made by clicking the matrix boxes and are active when a green tick  (**subscribed**) appears on the connection box. Audio from StarNet will now pass through to its routed location.

 (**In Progress**) Indicates a subscription in progress.

 (**Error**) Indicates a failed connection. This could occur under several circumstances. *See the Troubleshooting page.*

 (**Warning**) Indicates an unresolved subscription. Typically, this is because the transmitting device is not visible on the network (or because the transmitting device is switched off or removed from the network).

🟡 **(Pending)** Indicates that the device is part way through setting up a subscription.

## Configuring Hardware settings

The Audinate, Dante Controller application is used to configure the StarNet ADA24s sample rate, bit depth and additional settings. Dante Controller must be run on a Mac or PC connected to the Dante network. The unit will appear in Dante Controller as StarNetADA24. This name can be changed from within the Device View window.

StarNet ADA24 settings can be adjusted from the Device View window within Dante Controller.

To open the Device View window, click the Devices tab in the Dante Controller menu bar and select Device View; this will open the Dante Controller Device View window.

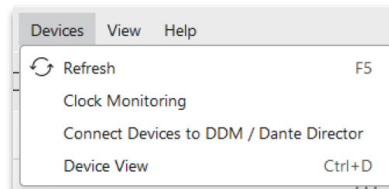

Select the Device you wish to configure in the drop-down menu.

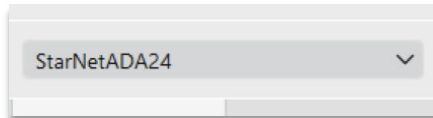

With the Device View window open, click on the Device Config tab.

From this window, the user can adjust sample rate, bit depth, pull-up/pull-down adjustments and device latency settings.

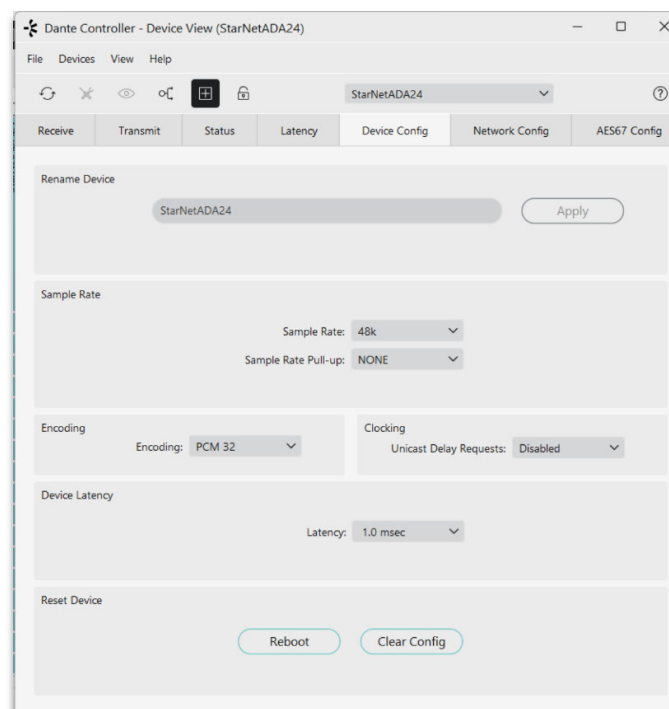

For more information on Dante Controller, visit-

[https://dev.audinate.com/GA/dante-controller/userguide/webhelp/content/front\\_page.htm](https://dev.audinate.com/GA/dante-controller/userguide/webhelp/content/front_page.htm)

## Dante Network Settings

---

The following settings are adjusted via Dante Controller.

**PRI: Leader**

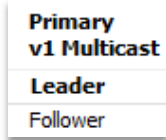

**PRI:** Displays the status of the Primary Dante network connection set by Dante Controller.

- **PRI: --** is displayed if no primary Dante network is discovered
- **PRI: Leader** is displayed when the StarNet ADA24 has been selected as the master clock for the Primary Dante network.
- **PRI: Follower** is displayed when the StarNet ADA24 is slaving to another device clock on the Primary Dante network.

**SEC: --**

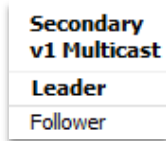

**SEC:** Displays the status of the Secondary Dante network connection and is set by Dante Controller.

- **SEC: --** is displayed if no secondary Dante network is discovered
- **SEC: Leader** is displayed when the StarNet ADA24 has been selected as the leader clock for the Secondary Dante network.
- **SEC: Follower** is displayed when the StarNet ADA24 is slaving to another device clock on the Secondary Dante network.

**Note: The Primary and Secondary status indicators reflect the Leader Clock selection from the connected Dante network. The user can select multiple units on the network as 'Preferred Master', but the network will choose only one as its 'Leader Clock'.**

The clock synchronisation protocol operates over primary and secondary networks in a redundant network. Each network will have a designated PTP leader clock; usually, this will be the same device on both networks. If this is not the case (e.g. if a non-redundant device is designated Preferred Leader), then one device will bridge the clock synchronisation information from the primary to the secondary network, ensuring that all devices derive their clock from the same source. Redundant PTP Follower clocks will synchronise their local clocks based on information from one of the connected networks. In the event of a failure on one network, a redundant device will continue to receive clock synchronisation information over the other network.

**SR: 96k**



**SR:** Displays the current Sample rate set for the ADA24.

The six available sample rates - **44.1kHz, 48kHz, 88.2kHz, 96kHz, 176.4kHz, or 192kHz** are set from the Dante Controller Device View window.

**PUP: None**

**PUP:** Displays the StarNet's Pull Up/Pull Down sample rate adjustment.

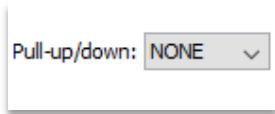

Pull Up/Pull Down settings of **-4%**, **-0.1%**, **+0.1%**, **+4.1667%** or **NONE** are set in the Device View of Dante Controller Device View window.



**CLK:** Displays the StarNet ADA24's clock source. The ADA24 can generate its clock (**INT**), take its clock source from the Dante network through the ethernet connection (**DANTE**), or synchronise to an external clock source via the rear-mounted WCLK I/P BNC connector (**WCK**).

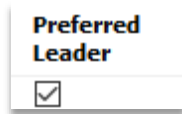

**CLK: INT** Reflects the user selection of **Preferred Leader** in Dante Controller. Once selected, and if there are no other Preferred Leader units on the network, the unit will default to its internal clock and will be selected as the clock leader for the network.

**CLK: DANTE** Indicates that the device is deriving its clock from the Dante network. This option is displayed when the unit is not set as Preferred Leader, and Network Status is showing **Follower**.

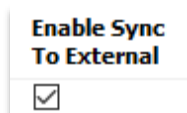

**CLK: WCK\*** Indicates that the unit has been set to sync to external Word Clock but has not locked to a valid Word Clock signal. External clock synchronisation is selected via the **Enable Sync To External** option in Dante Controller.

**CLK: WCK** Indicates that the unit is has been set to sync to external Word Clock and is locked to a valid incoming Work Clock signal.



**ENC:** Displays the ADA24's current bit depth encoding of **PCM 24**, or **PCM 32**.

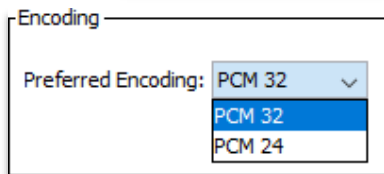

Preferred bit depth encoding is selected from the Device View of Dante Controller.



## Dante Information Window

After selecting **Info:View**, the device name will be displayed as assigned in Dante Controller.

Use the <> keys to view Rx/Tx channel names.

Rx 1-4 and 5-8 names are shown in the first window

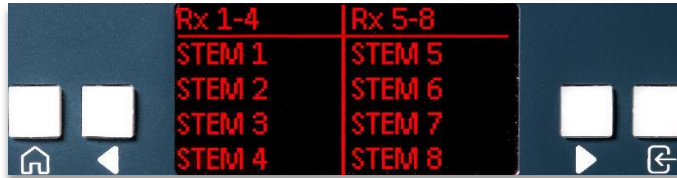

Rx 9-12 & 13-16 names are shown in the second window

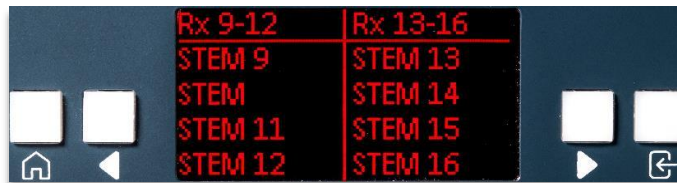

Rx 17-20 & 21-24 names are shown in the third window

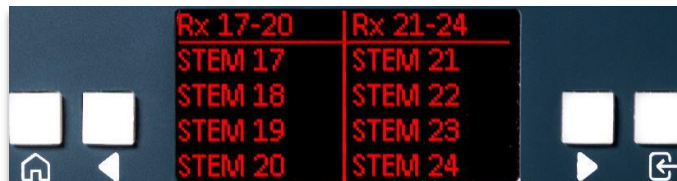

Tx 1-4 & 5-8 names are shown in the fourth window

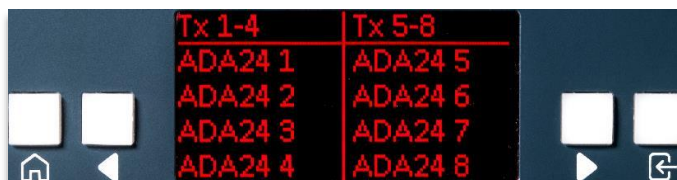

Tx 9-12 & 13-16 names are shown in the fifth window

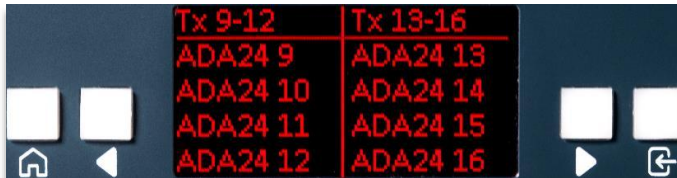

Tx 17-20 & Tx 21-24 names are shown in the sixth window

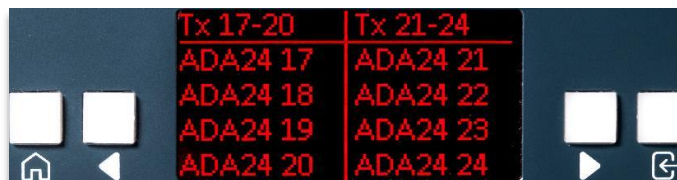

Rx and Tx names are renamed from the receive and transmit tabs of the Dante Controller Device View window.

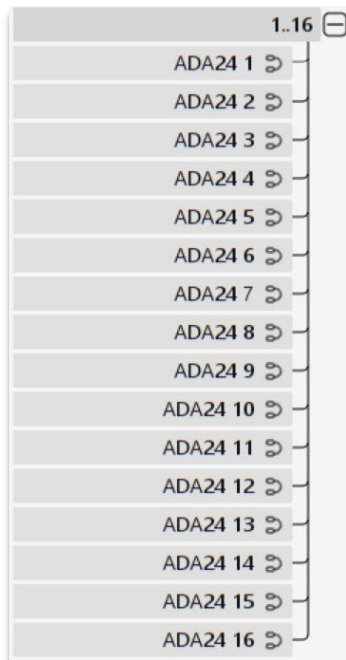
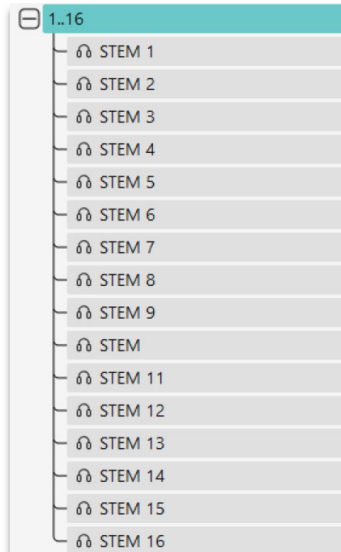

The Neve Firmware Updater app is used to check your unit's current firmware version and perform firmware updates if required. The app supports Windows 10/11 and Mac Intel/Silicon operating systems.

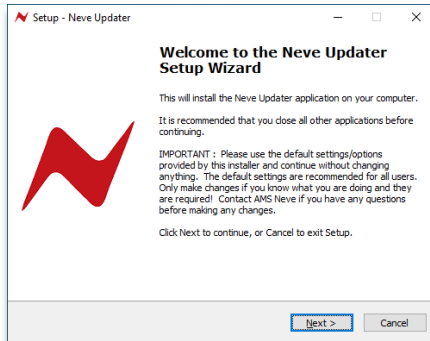

### Installation Instructions

The Neve firmware updater for Mac can be downloaded [here](#).

For Windows PC, the Neve firmware updater can be downloaded [here](#).

Run the installer package on your PC/Mac and follow the on-screen steps. Once installed, the computer is ready to be connected to your StarNet ADA24 via an Ethernet connection.

### Physical Connection Instructions

The StarNet ADA24 must be connected to the computer to perform a firmware update. This connection can be made in one of two ways.

- ▶ Via a direct **Mac/PC>Ethernet cable>ADA24 Comms port**. When connecting this way, **manual IP addresses must be assigned** on both the computer and StarNet ADA24.
- ▶ Via a network switch. **Mac/PC>Ethernet cable>Network Switch (the switch must also be connected to a valid network server)>StarNet ADA24**. This method uses auto-assigned DHCP IP addresses for the ADA24 and the computer.

*If using DHCP mode on a valid Network, skip the following manual IP address setup instructions.*

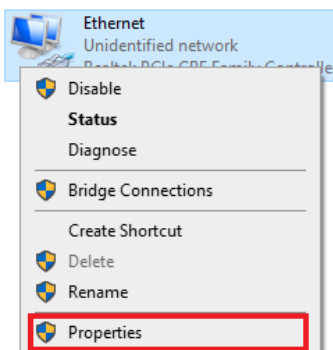
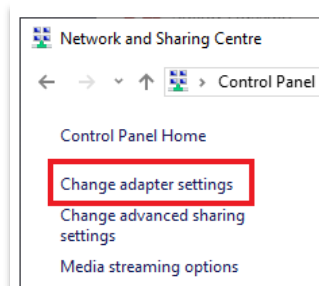

### Manual IP Address Setup - Windows PC

- ▶ Open **Control panel>Network&Internet>Network and Sharing Centre**
- ▶ Click **Change Adapter Settings**
- ▶ Highlight the **Ethernet** connection
- ▶ Click **Properties**

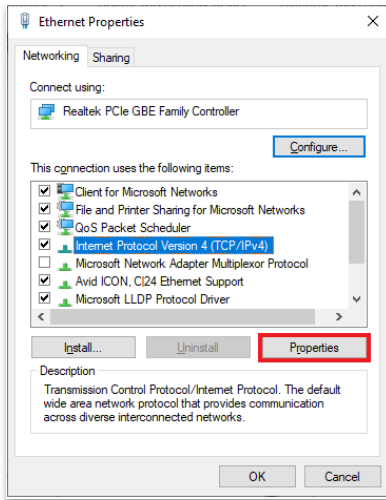

- ▶ Select **Internet Protocol version 4 (TCP/IPv4)**
- ▶ Click **Properties**

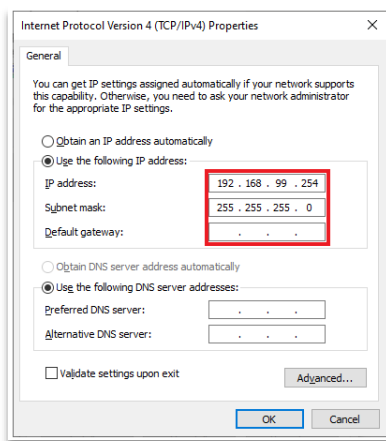

- ▶ Click **use the following IP address**
- ▶ Enter a manual IP address - **10.10.251.001**
- ▶ Enter Subnet Mask **255.0.0.0**
- ▶ Alternative address - **192.168.99.006**
- ▶ Alternative Subnet Mask **255.255.255.0**

### Manual IP Address Setup Mac

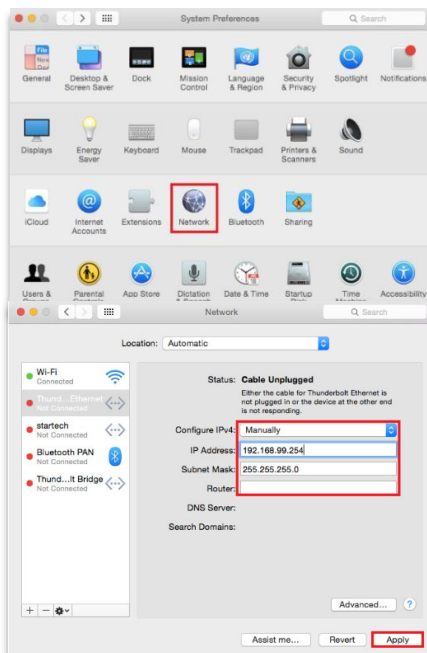

- ▶ Open **System Preferences**
- ▶ Click **Network**
- ▶ Select the Ethernet connection on the left
- ▶ Click the **Configure IPv4** drop-down box
- ▶ Select **Manually**
- ▶ Enter a manual IP address - **10.10.251.001**
- ▶ Enter **Subnet Mask 255.0.0.0**
- ▶ Alternative IP address – **192.168.99.001**
- ▶ Alternative Subnet Mask **255.255.255.0**

Once a manual IP address has been selected on the computer, the StarNet ADA24 manual address must be assigned within the same IP range.

## IP Address Setup - StarNet ADA24

---

If connecting through a valid DHCP network, then the StarNet can be set using **DHCP:Yes**

If connecting directly with an Ethernet cable from the computer to StarNet ADA24, a manual IP address must be set using the front panel controls.

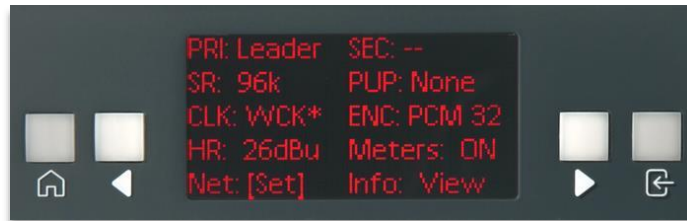



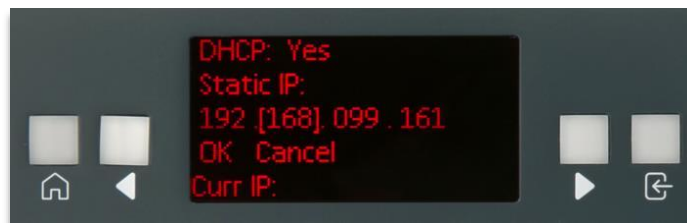

- ▶ Select **Net [Set]**

The Static IP window will appear.



Use the arrow keys to select each **[triple-digit]** section of the IP address.

- ▶ Press  to toggle up one number at a time
- ▶ Press and hold  and press  to toggle up 10 numbers at a time
- ▶ Press and hold  and press  to toggle down 10 numbers at a time

Enter a final address of:

- ▶ **10.10.251.006**
- ▶ Alternative address – **192.168.99.006**
- ▶ Select **[OK]** when complete
- ▶ Press  to confirm the Manual IP address and leave the Static IP window
- ▶ Select **[Cancel]** at any time to leave the Static IP window without entering an IP address
- ▶ **Current IP** will be displayed at the bottom of the screen



## Firmware Update Software Operation

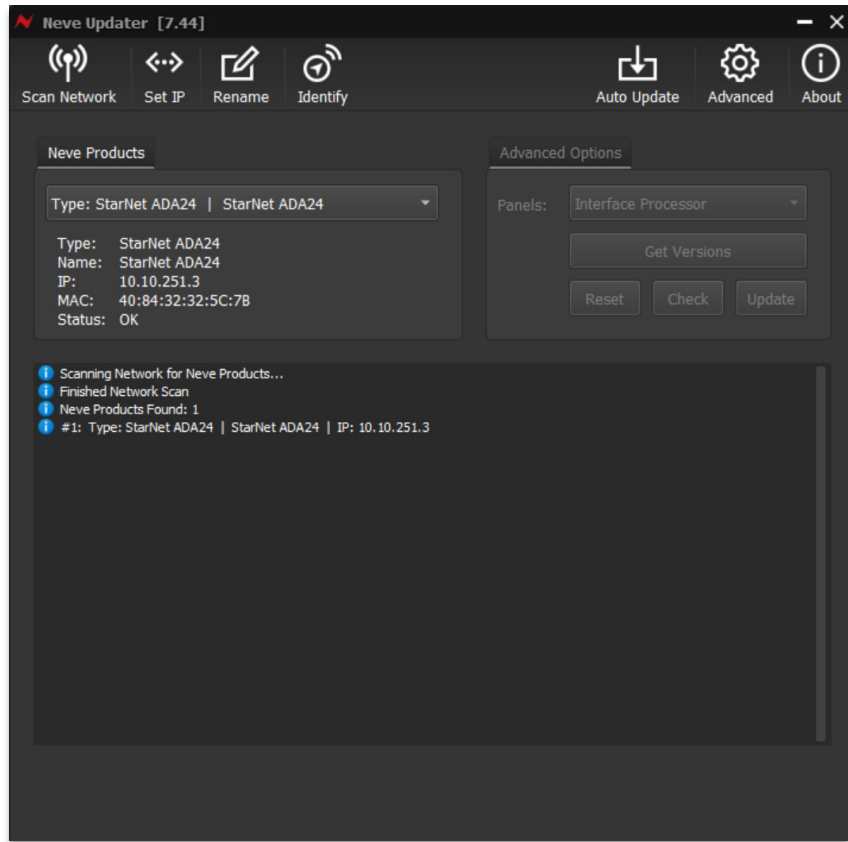

The Neve Updater program is a desktop application that can run on any Mac/PC. Once hardware is connected to the computer and IP addresses are set within the correct range, the software can be used to perform the necessary firmware updates.

### Performing a Firmware Update

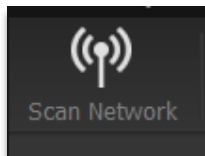

- ▶ Click **Scan Network**.
- ▶ Discovered units will appear in the **Neve Products** drop-down box.
- ▶ Product type, Name, IP address and Mac address are displayed underneath.
- ▶ Select the unit to update from the drop-down menu.

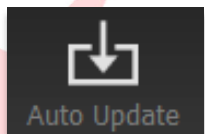
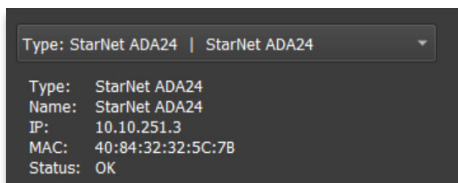

- ▶ Click **Auto Update**.
- ▶ Panels requiring firmware updates will appear on the app screen and the update process will begin.

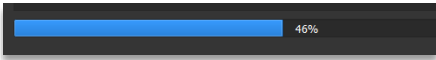

The software will update the firmware in three stages, which is indicated on the progress bar.

- 1<sup>st</sup> grey progress indicator is entering boot mode then another is shown to indicate erasing memory status.
- 2<sup>nd</sup> blue indicates update progress.
- 3<sup>rd</sup> grey indicates exiting program mode.
- Lower thin grey progress indicates overall progress.

**The StarNet ADA24 front panel will enter boot mode when programming, please do not press any buttons on the unit during this process.**

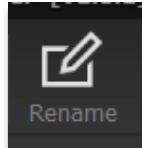

Units can be renamed by clicking **Rename** (Max 21 characters).

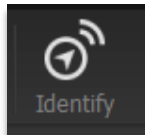

To identify your hardware units, select the unit from the drop-down menu then click **Identify**. The StarNet ADA24  button will flash to identify the unit.

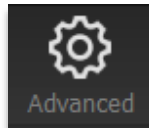

**Advanced** is reserved for the use of AMS Neve engineers when manually uploading firmware.

**It is not recommended for end-users to enter this mode.**

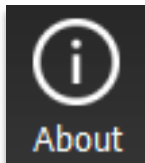

The **About** window displays the software system information and the available firmware versions.



**Set IP** is used to reduce the scanning time when searching for units.

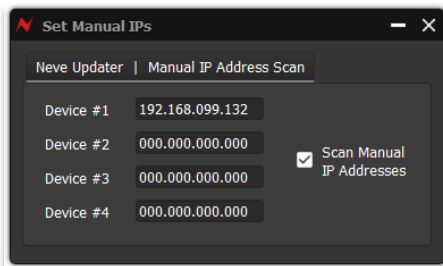

If using manual IP addresses, the Set IP option can be used to focus the Neve updater app onto the hardware by only scanning for the specific manual address, rather than through the entire available range. The pop-up window allows manual IP addresses to be entered for each device on the network.

Click 'Scan Manual IP addresses' to confirm.

## Mac OS X Notes

---

For some Mac user accounts, certain applications may be quarantined upon installation. This is a security setting on Apple's operating system; if the Neve Updater app is quarantined, it may not work correctly. If when updating firmware, the message '**Update Firmware File Missing**' appears, please ensure that the Neve updater app is not quarantined and follow the steps below:

- ▶ Open Terminal from - Applications/Utilities/Terminal
- ▶ Enter the following command: **xattr -d -r -s com.apple.quarantine "/Applications/app or folder name"**
- ▶ where app or folder name is the name of the folder or application to modify, for example /Applications/Neve Updater/
- ▶ It is recommended to run the command on folders rather than apps
- ▶ Enter your user/admin password when prompted
- ▶ Close Terminal window

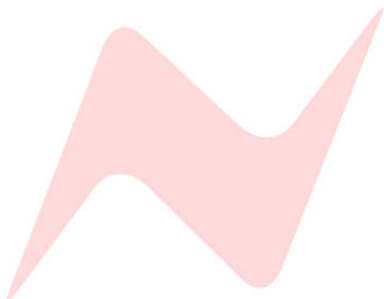

## StarNet ADA24 Remote App

The StarNet ADA24 Remote app is used to remotely mute/cut the analogue outputs of any ADA24 present on the communications network and attenuate the final output level of the ADA24 DAC remotely. This is particularly useful when using the ADA24 as a DAC for a multi-channel loudspeaker monitoring system. The app supports Windows 10/11 and Mac Intel/Silicon operating systems.



### Installation Instructions

The Mac app can be downloaded [here](#).

The Windows PC app can be downloaded [here](#).

Run the installer package on your PC/Mac and follow the on-screen steps.

Once installed, the computer is ready to be connected to your StarNet ADA24 via an Ethernet connection. *See page 22 for physical connection instructions.*

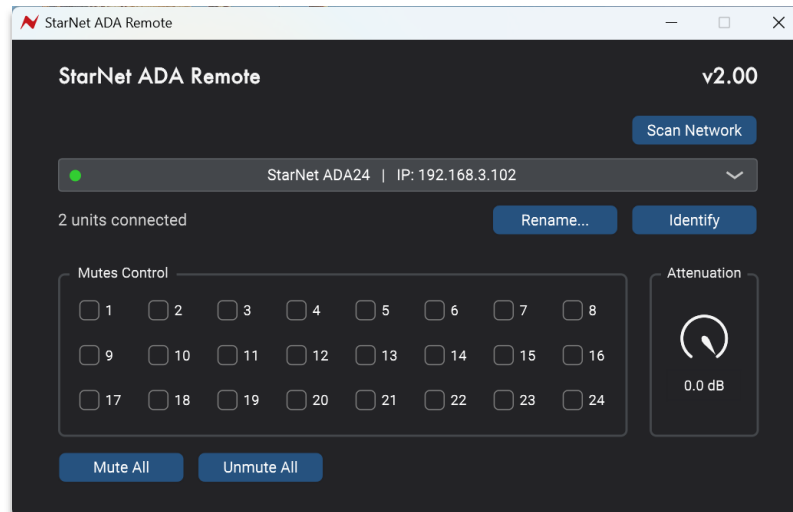

### StarNet ADA24 Remote Software Operation

When first opened the app will automatically scan the ethernet network for ADA24 units. The **Scan Network** button allows for manual scanning once the app is open.

Once units are discovered, they appear in the dropdown menu, including unique unit name and IP.

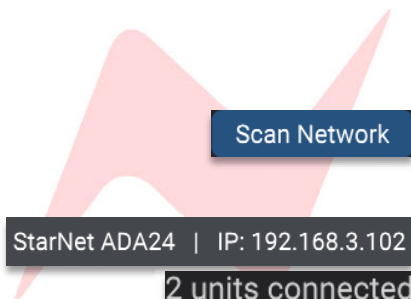



Click the **V** arrow to select a unit from the list.



The **Network Status indicator** will display as Green if the discovered unit has valid communication with the control computer. This will change to Red if there are communication issues with the selected unit.

Type: StarNet ADA24  
Name: StarNet ADA24  
IP: 192.168.3.102  
MAC: DB:AC:EC:DD:EE:02  
Status: OK

Hovering over the network status indicator with the mouse reveals a pop-up window showing further detail on the selected unit, including Type, Name, IP address, MAC ID number and Status.

Identify

**Identify** – sends a comms signal to the hardware to identify the unit, indicated by flashing the  switch on the selected ADA24.

Rename...

**Rename** – allows for a unique name to be applied to the selected ADA24.

### Mutes Control

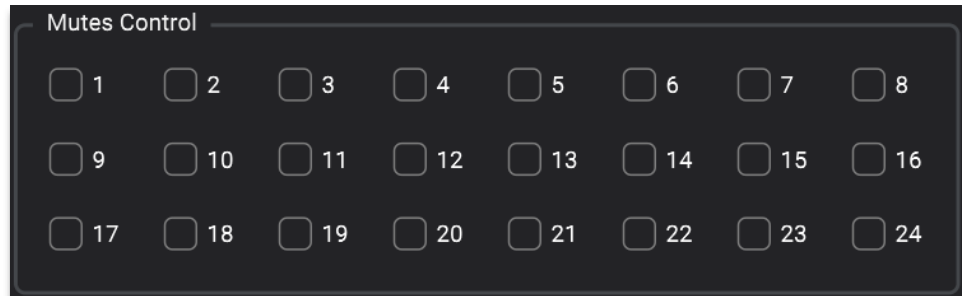

Once the unit is selected from the dropdown menu, the Mute channels tick boxes can be used to cut/mute the analogue outputs for the selected unit.



**Unticked – Output active.**



**Ticked – Output disabled.**

Mute All

**Mute All** – activates all 24 mutes for the selected unit.

Unmute All

**Unmute all** – deactivates all 24 mutes for the selected unit.

### Attenuation



The final output level of the ADA24 24 analogue outputs can be remotely attenuated from the Attenuation GUI control.

This on-screen rotary-style control can be adjusted via the computer mouse to attenuate the output of all 24 ADA24 DACs in unison.

The attenuation functions from 0.0dB at the maximum clockwise position, ranging to -127.5dB at the maximum anticlockwise position, with attenuation steps of 0.5dB across this range.

Attenuation levels and Mute states are remembered per unit on power down, resulting in each unit powering up in an 'as-was' state.

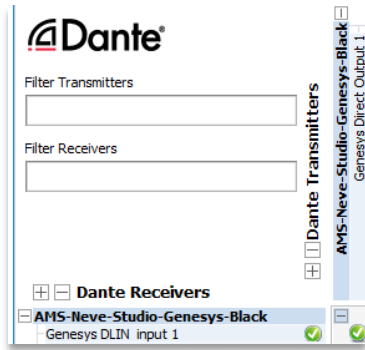

### No audio at the Line Output(s)

- ▶ Check all connections to the unit, D-sub line inputs and outputs.
- ▶ Check that corresponding inputs and outputs are routed to the same channel via the Dante Controller app (line Input 1 to Line output 1 etc.) ✓ will display a valid subscription.
- ▶ Check that Meters are switched on by pressing the **METERS OFF** button (RED=Meters off/Unlit=Meters on).
- ▶ The front panel signal led/s will light if any signal is detected.
- ▶ Recheck Line outputs.
- ▶ Follow steps at the link below to troubleshoot Dante networking issues.  
<https://www.getdante.com/support/faq/?category=networking>



## Dimensions & power Requirements

<b>Height</b>	88mm/3.5 inches
<b>Width</b>	483mm/19 inches
<b>Depth</b>	350mm/13.78 inches
<b>Weight</b>	5.075kg
<b>Heat Dissipation</b>	30 watts
<b>Power factor</b>	>0.90
<b>Voltage</b>	Input Voltage Range 90-240v AC Only
<b>Current Amps RMS 240v</b>	0.14A
<b>Current Amps RMS 90v</b>	0.33A
<b>Current</b>	Switch-On surge current – 65A Peak @ 240v

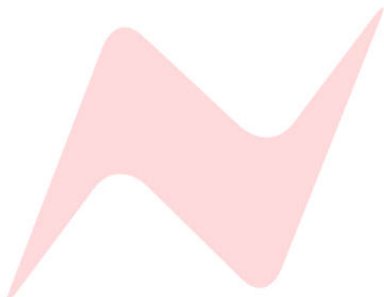

## Audio Specification

General Specifications	
Headroom	+18, 24 or 26dBu (switchable) <0.0008% distortion
Frequency Response	Typically +/- 0.1dBu, 10Hz to 30kHz (measured at 96kHz)
Distortion (THD+N)	Typically <0.0008% @ 1kHz (measured at +26dBu, 10Hz to 80kHz filter)
Line Inputs	Input Impedance ≈12kΩ
Line Outputs	Output Impedance ≈50Ω
Crosstalk	
Inter-channel crosstalk	<110dBu @ 1kHz

## A/D Input Specification

Line Level In (26dB H/R setting)

Sample Rate	Frequency Response	Dynamic Range	Distortion (THD+N)
48kHz	+/- 0.1dBu 10Hz – 22kHz	>119dBFS <sup>1</sup>	<0.0007% <sup>2</sup>
96kHz	+/- 0.1dBu 10Hz to 30kHz +/- 1dBu 4Hz to 44kHz	>119dBFS <sup>1</sup>	<0.0007% <sup>2</sup>
192kHz	+/- 0.1dBu 10Hz to 22kHz +/- 1dBu 4Hz to 44kHz +/- 3dBu 4Hz to 88kHz	>119dBFS <sup>1</sup>	<0.0007% <sup>2</sup>

Device Latency determined by Dante network configuration

<sup>1</sup>Dynamic Range (A weighted), 22Hz, 22kHz filter ON

<sup>2</sup>Distortion measured with a 26dBu 1kHz input signal, headroom set to +26dB

## D/A Output Specification

Sample Rate	Frequency Response	Output Noise	Dynamic Range	Distortion (THD+N)
48kHz	+/- 0.1dBu 5Hz – 22kHz	<-96dBu <sup>3</sup>	>122dBu <sup>4</sup>	<0.0008% <sup>5</sup>
96kHz	+/- 0.1dBu 5Hz to 40kHz +/- 1dBu 3Hz to 46kHz +/- 3dBu 2Hz to 46.5kHz	<-96dBu <sup>3</sup>	>122dBu <sup>4</sup>	<0.0008% <sup>5</sup>
192kHz	+/- 0.1dBu 5Hz to 40kHz +/- 1dBu 3Hz to 85kHz +/- 3dBu 2Hz to 92kHz	<-95dBu <sup>3</sup>	>121dBu <sup>4</sup>	<0.0008% <sup>5</sup>

Device Latency determined by Dante network configuration

<sup>3</sup>Noise (A weighted), 22Hz, 22kHz filter ON

<sup>4</sup>Dynamic Range (A weighted), 22Hz, 22kHz filter ON

<sup>5</sup>Distortion measured with a 26dBu 1kHz output signal, headroom set to +26dB

## Unit Connection Tables

<b>External PSU Mains, fused @ 4 amps</b>	<b>5 pin male XLR</b>
<b>Line Inputs</b>	<b>25-way D-Type, Tascam convention</b>
<b>Line Outputs</b>	<b>25-way D-Type, Tascam convention</b>
<b>Word Clock Input</b>	<b>75 Ohm BNC</b>
<b>Word Clock Output</b>	<b>75 Ohm BNC</b>
<b>Dante Primary</b>	<b>RJ45 Ethernet</b>
<b>Dante Secondary</b>	<b>RJ45 Ethernet</b>
<b>Comms</b>	<b>RJ45 Ethernet</b>

### Line Input 1-8 D-Type 25-Way Pin Outs

Signal	Name	Pin		
		Hi	Lo	Screen
<b>1</b>	Line Input 1	24	12	25
<b>2</b>	Line Input 2	10	23	11
<b>3</b>	Line Input 3	21	9	22
<b>4</b>	Line Input 4	7	20	8
<b>5</b>	Line Input 5	18	6	19
<b>6</b>	Line Input 6	4	17	5
<b>7</b>	Line Input 7	15	3	16
<b>8</b>	Line Input 8	1	14	2

### Line Input 9-16 D-Type 25-Way Pin Outs

Signal	Name	Pin		
		Hi	Lo	Screen
<b>1</b>	Line Input 9	24	12	25
<b>2</b>	Line Input 10	10	23	11
<b>3</b>	Line Input 11	21	9	22
<b>4</b>	Line Input 12	7	20	8
<b>5</b>	Line Input 13	18	6	19
<b>6</b>	Line Input 14	4	17	5
<b>7</b>	Line Input 15	15	3	16
<b>8</b>	Line Input 16	1	14	2

### Line Input 17-24 D-Type 25-Way Pin Outs

Signal	Name	Pin		
		Hi	Lo	Screen
1	Line Input 17	24	12	25
2	Line Input 18	10	23	11
3	Line Input 19	21	9	22
4	Line Input 20	7	20	8
5	Line Input 21	18	6	19
6	Line Input 22	4	17	5
7	Line Input 23	15	3	16
8	Line Input 24	1	14	2

### Line Outputs 1-8 D-Type 25-Way Pin Outs

Signal	Name	Pin		
		Hi	Lo	Screen
1	Line Output 1	24	12	25
2	Line Output 2	10	23	11
3	Line Output 3	21	9	22
4	Line Output 4	7	20	8
5	Line Output 5	18	6	19
6	Line Output 6	4	17	5
7	Line Output 7	15	3	16
8	Line Output 8	1	14	2

### Line Outputs 9-16 D-Type 25-Way Pin Outs

Signal	Name	Pin		
		Hi	Lo	Screen
1	Line Output 9	24	12	25
2	Line Output 10	10	23	11
3	Line Output 11	21	9	22
4	Line Output 12	7	20	8
5	Line Output 13	18	6	19
6	Line Output 14	4	17	5
7	Line Output 15	15	3	16
8	Line Output 16	1	14	2

## Line Outputs 17-24 D-Type 25-Way Pin Outs

Signal	Name	Pin		
		Hi	Lo	Screen
1	Line Output 17	24	12	25
2	Line Output 18	10	23	11
3	Line Output 19	21	9	22
4	Line Output 20	7	20	8
5	Line Output 21	18	6	19
6	Line Output 22	4	17	5
7	Line Output 23	15	3	16
8	Line Output 24	1	14	2

