

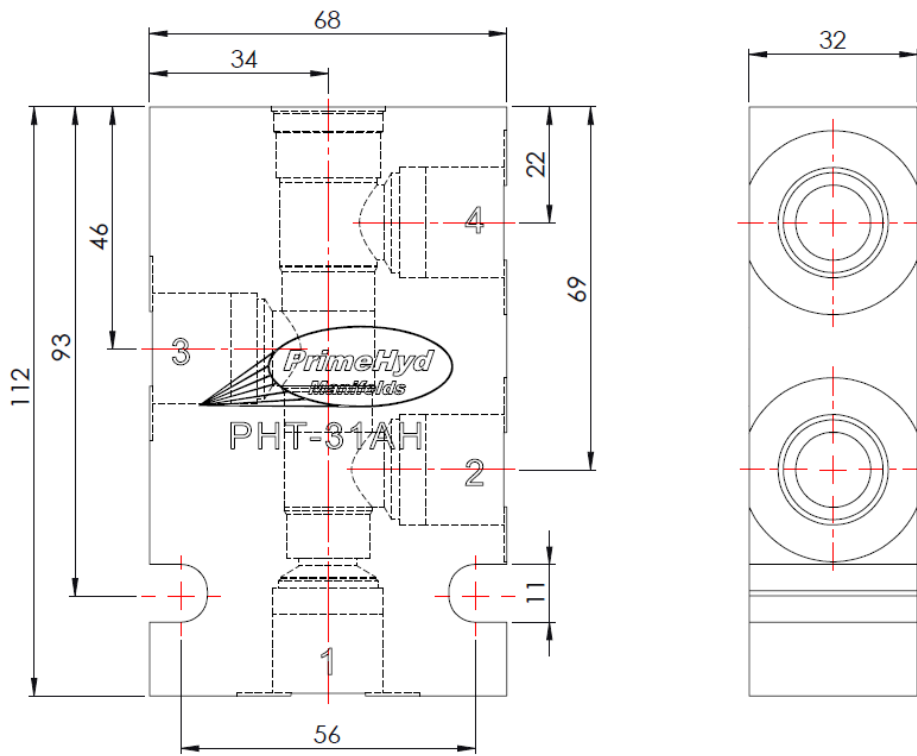

SUN CAVITY HOUSING

PHT-31A#⁽¹⁾



CAVITY	PORT1	PORT 2	PORT 3	PORT 4
T-31A	1/2" BSPP	1/2" BSPP	1/2" BSPP	1/2" BSPP

ALL DIMENSIONS ARE IN mm U.O.S.

(1) SUFFIX:

H = STEEL (65-45-12) – 350 Bar Max.

M = ALUMINIUM (6061-T6) – 210 Bar Max.

<http://www.primehyd.com.au>

sales@primehyd.com.au

Phone: +61 8 9248 4144

