

HANDLER

16B RED WING LATHE & CHUK/CHANGER OPERATING MANUAL

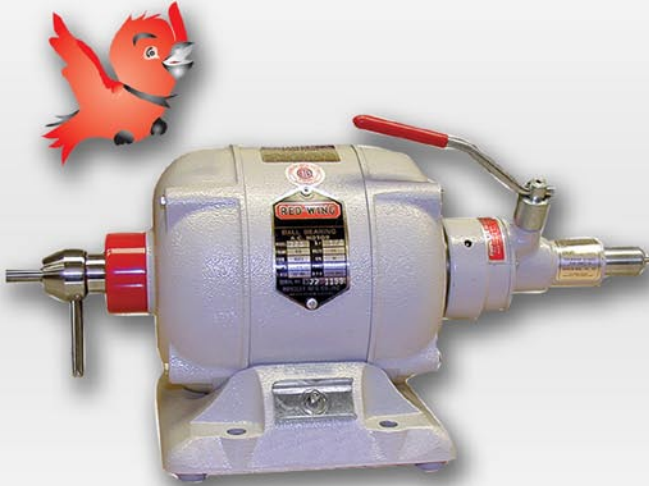

Made in the U.S.A. Since 1920

DO NOT DISCARD

**IMPORTANT INSTRUCTIONS
[06/2009]**

**WARNING!
FOR YOUR SAFETY PLEASE READ INSTRUCTIONS
BEFORE OPERATING TOOL & WEAR EYE PROTECTION**

THANK YOU FOR PURCHASING A HANDLER PRODUCT

Thank you for purchasing a HANDLER's Red Wing Lathe.

Open the carton and inspect all contents. Your 16B was inspected several times during the manufacturing process, plus as a completed unit after it was built and tested.

Should damage have occurred, please contact the freight forwarder, immediately. Failure to contact the freight forwarder, immediately, will result in the loss of your rights to place a claim for possible external or internal damage.

After you have contacted the freight forwarder, please contact your distributor advising that you have received a unit which sustained damage, detailing the possible damage and requesting they contact Handler. Possible damage **MUST BE CLAIMED** by the receiver of the product, not the sender.

RED WING MOTOR

Your Red Wing has been inspected prior to being shipped. Open the package and inspect its contents. Should damage have occurred in transit, contact the freight forwarder immediately. Do not contact Handler as the receiver of a product must file a claim for damage within 14 days. Failure to file a claim in a timely manner could result in the loss of your rights of recovery. Should you require assistance, please contact Handler Manufacturing at: 1-908-233-7796 or 1-800-274-2635

CAUTION!

BEFORE Connecting and Operating!
Unpack Accessories from Unit
For Your Protection EXAMINE THE GOODS.

WARNING!

SAFETY INSTRUCTIONS!

**WARNING FOR YOUR SAFETY:
READ INSTRUCTIONS BEFORE
OPERATING TOOL.**

WEAR EYE PROTECTION!

ALL ELECTRICAL ITEMS WITH A CORD SET:

**REPAIR OR REPLACE DAMAGED
OR WORN CORD IMMEDIATELY.
DO NOT EXPOSE TO RAIN OR USE IN
DAMP LOCATIONS.**

**ADVERTISSEMENT:
NE PAS EXPOSER A LA PLUIE
ET NE PAS UTILISER DANS LES
EMPLACEMENTS HUMIDES.**

HANDLER

CHUCK REMOVAL INSTRUCTIONS

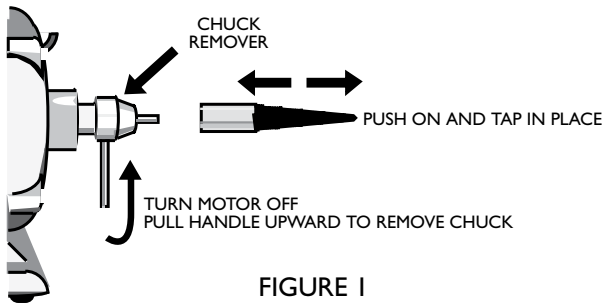

FIGURE 1

Remove the lathe from the carton and place it in a suitable location on a sturdy horizontal surface. The unit must be bolted to the table top. Bolting the unit securely to a solid table top will prevent possible lathe movement during operation and possible operator injury.

Plug the lathe's cord set into a grounded 115 Volt/60 Hz electrical socket only. Do not utilize a 3-2 prong adapter. Failure to plug the lathe into a properly grounded receptacle may result in operator injury. Your lathe is now ready for operation with the aid of chucks placed on the shaft (see instructions).

The No. 26, 26A, 26L, and 28H lathes are constructed to function on two speeds. Low speed is 1725 RPM and high speed is 3450 RPM. The lathe shaft is provided with special dental tapered shafts which will accept chucks which fit onto a tapered shaft only. The models 27, 29, & 29A are built to function at 3450 RPM. NOTE: if you have specified that your lathe should contain 1/2" straight shafts, only chucks which contain a 1/2" arbor hole will adapt to these shafts.

The polishing motor with a tapered shaft is provided with a left and right chuck remover (see figure No. 1). By pulling upward toward the front of the lathe, the chuck remover will unscrew outward to "push" the chuck from the tapered shaft. Various types of chucks and chuck accessories are utilized to perform different types of grinding and polishing operations with your lathe. These are attached to your lathe's shaft via a friction fit.

TO PLACE A CHUCK ONTO THE SHAFT OF YOUR LATHE, PLEASE FOLLOW THESE INSTRUCTIONS:

1. Make certain both the lathe's shaft and the arbor hole of the chuck to be placed onto the shaft are clean of any dust and debris. Be certain the chuck remover on each side is in place.
2. With the lathe turned "OFF", place the chuck onto the right or left shaft of your lathe. DO NOT place a chuck labeled "R" or "L" on the opposite shaft. (See Instructions on following page.)
3. Push the chuck onto the shaft as far as it will go. Since the chucks fit onto tapered shafts via friction fit, make certain the chuck is placed securely on the lathe shaft. It may be necessary to tap the end of the chuck onto the lathe shaft with the aid of a soft rubber, plastic or leather mallet. Do not use a metal hammer or mallet as this will damage the chuck.
4. After the chuck has been placed securely on the lathe shaft, place the buff, brush, abrasive wheel, bur or mandrel onto the chuck. Secure this in place as per the manufacturers suggestions.
5. Turn the lathe on and make certain the accessory which has been placed on the lathe chuck is securely in position. If either the chuck or accessory have not been secured to the lathe shaft, secure it now.

NOTE: Many Red Wing polishing motors are shipped with 1/2" straight shafts. Chucks used on Red Wing Polishing motors equipped with a 1/2" straight shaft utilize a set screw to hold the chuck in position. Make certain to tighten this securely.

IMPORTANT NOTICE

Adjusting Chuk/Changer to Tension Collets

The alignment of the Chuk/Changer to the clutch will alleviate slipping clutch noise problems and tension collets. Please follow the instructions, below, to alleviate these problems.

1. Remove the plug which connects the lathe from the electrical source.
2. Move the activating handle on the Chuk/Changer to the six o'clock (open collet) position as seen in diagram 1.

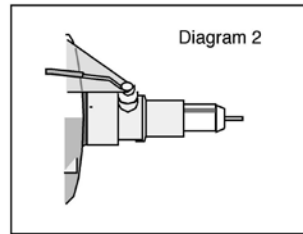
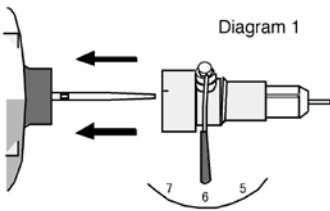

3. Loosen the top set screw and the two lower set screws, which are found on the 2-1/2" adapter, which hold the Chuk/Changer onto the lathe.
4. Place your left hand on the left hand side of the lathe and your right hand on the nose section of the Chuk/Changer, and push the Chuk/Changer in toward the lathe as far as it will go. It will move approximately 1/32-1/16 of an inch inward toward the lathe.
5. Holding the Chuk/Changer in your right hand, move the activating handle clockwise to the 9:30- 10:00 o'clock position. The Chuk/Changer will move outward, slightly. Tighten the three set screws on the adapter which were previously loosened, holding the Chuk/Changer in position as seen in diagram 2.

NOTE: If you have another person available to assist you in this short procedure, ask them to tighten the set screws. If you do not, make certain that you hold the Chuk/Changer inward toward the lathe when you tighten the set screws on the adapter.

This should alleviate the squeaking-grinding noise you are hearing by the lathe Chuk/Changer combination and place proper tension on collets.

REMEMBER: Clean collets every 30 days.

Your Chuk/Changer has been manufactured, assembled, adjusted and tested with the utmost of care to insure that you will receive it in perfect condition. We ask that you carefully read and follow these step by step instructions.

CHUK/CHANGER INSTALLATION

Fig. 1

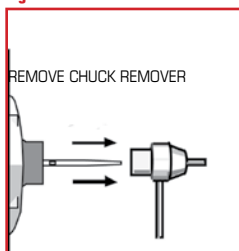

1. Remove the chuck remover completely from the right side (or for the left handed Chuk/Changer) of the lathe (See Fig. 1).
If you have a lathe manufactured prior to 1972, remove the set screw holding the chuck remover located on the rear at the lathes red hub. Remove the chuck remover completely.

Fig. 2

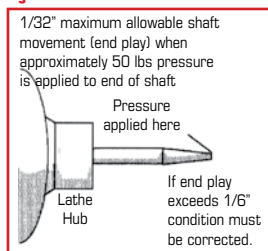

2. Remove the red polymer cap from the motor hub. Sand and/or scrap all paint from 2" diameter lathe hub using the emery cloth provided. (See Fig. 3)
3. Using emery cloth, remove burs, rust or paint from the 1/2" portion of the motor shaft.

Fig. 3

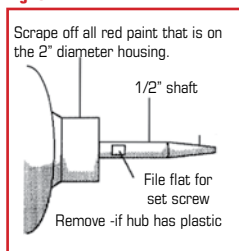

4. Place clutch on to 1/2" portion of the shaft, sliding clutch onto 1/2" portion to shoulder inside 2" hub. The large diameter of the aluminum portion of the clutch should be positioned approximately 1/6" from the 2" hub. (See Fig. 4)
5. Tighten set screw to mark the shaft slightly. Loosen set screw and remove clutch. File a small flat section where clutch screw secures to 1/2" position of the shaft. Lightly sand filed portion to remove the burr, caused by filing. Replace clutch tightening set screw securely.

Fig. 4

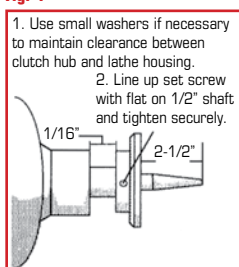

6. With Chuk/Changer handle in 6 o'clock position, place Chuk/Changer with hub adapter on to lathe hub.

A slight pressure may be necessary to accomplish this procedure. Tighten set screw in Chuk/Changer's hub adapter, evenly

Fig. 5

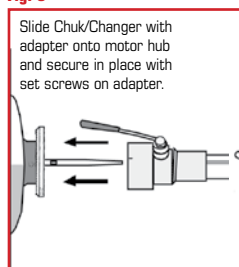

7. Slowly rotate chuck handle clockwise, to 9:30 o'clock position. Allow handle to ease into position. Should the handle stop beyond the 10:30 o'clock position, the chuck has not been "slid" on to the hub properly. (Place the handle in the 6 o'clock position and repeat Step 6 above, pushing the entire assembly towards the lathe.

Fig. 6

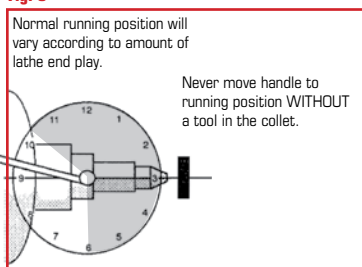

8. Having adjusted the clutch handle into the proper position, secure all set screws on the adapter.

9. The operating range of the clutch handle is 6:00 o'clock counter-clockwise to OPEN the collets and 9:30-10:30 o'clock to CLOSE collets. **MAKE CERTAIN** never to close the collets without a tool in it.

10. Clean collets every 30 days. Lubricating outside of collets with a LIGHT coat of silicone grease-ONLY. Always keep a tool in the collets so the hardened collets will not take a smaller diameter set.

NOTE: Should the clutch handle stop before the 9:30 o'clock position, the adapter set screws should be loosened and the entire chuck assembly pulled away from the lathe.

QUESTIONS? Review FAQ section on our website at: www.handlermfg.com or call 1-908-233-7796.

INSTALLATION & MAINTENANCE

CLUTCH SPRING ADJUSTMENT

Loosen the set screw on the spring housing. Hold the handle in running position 9:15-10:30 o'clock. Rotate spring housing counter-clockwise about 3/4 of a turn or until set screw is facing approximately 11:00 o'clock position. Tighten set screw securely. See insert diagram for correct spring housing set screw position.

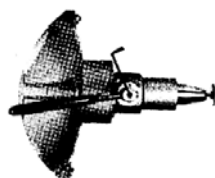

REPLACING CLUTCH SPRING

The clutch spring may be damaged if the handle is forced beyond limits. See diagram at right. Chuk/Changer should be installed on lathe while clutch spring is being replaced. Remove Chuk/Changer handle by loosening handle set screw. (Note: Mark side of cam shaft from which handle is removed in order to facilitate proper replacement. Loosen the set screw on the spring housing. Remove spring housing. Discard damaged spring. Insert new spring short end first into small hole in spring housing. Replace spring housing. Care should be taken to be sure long end of spring enters small hole in chuck housing. Replace handle and follow the adjustment procedure under Clutch Spring Adjustment.

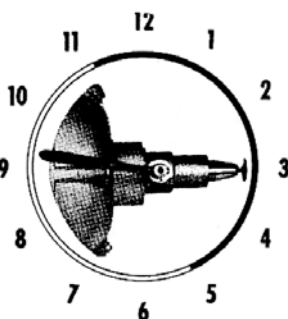

REMOVE CHUCK FROM LATHE

Always move handle straight down (6:00 o'clock) and leave it in this position if you have any reason to remove the chuck from the lathe. If handle is moved, the clutch spring (Part No. 7) may be damaged or clutch spring tension may be released. When clutch spring is damaged or tension released clutch will not engage properly. See instructions under Clutch Spring Adjustment and replacing clutch spring. Normally it is not necessary to remove the adapter or clutch from the lathe when you return the chuck to the factory for repair. If it is necessary to remove adapter or clutch refer to the installation instructions for your particular model lathe. Serious damage to clutch or adapter will result if instructions are not followed.

OVERHEATING

A new or rebuilt Chuk/Changer will normally run quite warm (very uncomfortable to the touch) during the break in period. The break in period will usually last several weeks depending upon speed and amount of use. Worn collects, collets not screwed in all the way or too long a stop (Part No.3) will cause overheating, especially in the front portion of the Chuk/Changer.

SQUEAKING CLUTCHES

After several months of service, a clutch may glaze and develop a squeak. The squeak is usually most noticeable as the lathe is coasting to a stop. Remove chuck from lathe (see instructions under removing chuck from lathe) and lightly sand both fiber and steel clutch surfaces. If squeaking persists and there is a presence of excessive amounts of dust around the clutch area, the adapter is improperly mounted, causing misalignment of the clutches. Refer to installation instructions for your model lathe.

OPERATION AND CARE INSTRUCTIONS

CAUTION

Do not attempt to operate Chuk/Changer unless it is properly installed on lathe.

Never oil or use solvents of any kind on Chuk/Changer

Never close collet without a tool (chuck, burr, etc.) in the collet. Allow clutch spring to engage clutch. (Never push up on handle or let handle snap up.)

Do not remove or attempt to defeat the purpose of the safety strap.

OPERATION

Normal running position, handle 9:15 o'clock to 10:30 o'clock.

To disengage clutch, bring handle down to 8:00 o'clock position, counter-clockwise.

To apply brake, bring handle down to approximately 7:00 o'clock position, counter-clockwise.

(Note: Brake position is used for changing arbor bands, buffing wheels, etc.) To open collet, bring handle straight down to 6:00 o'clock position. Tools (chucks) burrs, etc., may be changed while handle is in straight down (6:00 o'clock) position.

USE OF 3/32" DIAMETER SHANK TOOLS IN CHUK/CHANGER

1. With handle straight down, insert tool in inner collet to desired depth.
2. Move handle clockwise to approximately 8:00 o'clock position.
Remove hand from tool and allow clutch spring to return handle to running position.
3. Never push up on handle.

USE OF 1/4" DIAMETER SHANK TOOLS IN CHUK/CHANGER

1. With handle straight down, insert chuck shank into outer collet.
Note: The inner collet will be pushed back inside Chuk/Changer
2. While holding tool in collet, move handle clockwise to approximately 8:00 o'clock position.
3. Remove hand from tool and allow clutch spring to return handle to running position.
4. Never push up on handle.

CLEAN COLLETS EVERY 30 DAYS

1. With lathe switch OFF and clutch handle straight down, (collets open) unscrew outer collet (part No.5) with collet wrench (Part No.8) Unscrew counter-clockwise.
2. Remove both inner and outer collets
3. Thoroughly clean collet, you may use solvent to clean collets, however, you must remove all traces of solvent before replacing.
4. Thoroughly clean collet body hole by using pipe cleaner or small cloth on end of instrument.
Do not use any solvents in this hole. Put a thin film of grease on outside of both collets. (This purpose of this cleaning is to lubricate and prevent rust. Failure to clean and grease will cause collets to slip and stick.)
5. Replace collets, with collet wrench, screwing clockwise.

REPLACING WORN COLLETS

When tools (chucks) burrs, etc. begin to slip, collets should be replaced.* When replacing collets, always use the shortest possible stop. Part No.3, that will still allow the tools to slip into the master collet. WE recommend that you keep spare collets Part No.1 and No. 5 and a set of stops, Part No.3S on hand at all times.

HOW TO REMOVE A STUCK COLLET

A collet may get rusty or dirty and stick if it is not cleaned and greased regularly, or it may stick if collet is closed without a tool in the collet. Open collet by moving handle straight down (collet open). Put collet wrench in collet and tap lightly on the end of the collet wrench and at the same time attempt to unscrew the collet. If this does not loosen the collet, with the handle in the same position, remove the four screws that hold the chuck on the adapter and remove chuck. Caution: be sure not to move the handle during this procedure. See instructions under removing chuck from lathe. Grasp the steel clutch plate to keep it from turning while you remove the collet.

*However, make certain collets have been properly cleaned. Dirty collets may also cause chuck slippage.

CARE AND MAINTENANCE

PROTECTION - IMPORTANT

1. Never attempt to use a polishing motor without proper instruction.
2. Never use a polishing motor unless the motor has been fitted with polishing splash hoods or a similar protective device containing a protective shield.
3. Always use a dust collector when performing polishing or grinding operations.
4. Read and follow all instructions contained in this manual regarding "tool safety." Handler manufactures a full line of Chucks, Splash Hoods, Dust Collectors, and Protective Shields. Contact us at the number below to request a Handler Catalogue.

CHUCK REMOVAL

After finishing and completing a polishing or grinding operation, you may wish to remove the chuck accessory and change to another type of chuck or accessory. This is completed as follow:

1. Turn the lathe off and allow the shaft to come to a complete stop.
2. Using the chuck remover located on the left or right side of the lathe, pull upward on the remover's handle. This will push the remover outward, and push the chuck from the lathe shaft, (See Figure 1. Page 4).

A few chucks may require the chuck remover to be rotated 360 Degrees before the chuck accessory is removed. Chucks fitted to polishing motors containing a 1/2" shaft are removed by loosening the set screw which holds it in position.

3. To place another chuck onto the lathe shaft, follow the procedure listed on this page.

CARE AND MAINTENANCE

Your Red Wing polishing motor has been fitted with ball bearings. No further lubrication is necessary during the life of your motor. Occasionally remove the motor's cord set from its electrical source and wipe the unit clean with a clean, soft cloth. DO NOT use abrasive or liquid cleaners. Read, fully, the safety instructions contained on page 6.

ACCESSORIES

Handler manufactures a full line of Chucks, Protective Hoods, Shields, and Dust Collectors for use with your Red Wing motor. Handler chucks are precision manufactured to fit onto your Red Wing motor. A few of these are described below.

The No. 7 L or R chuck is made to accommodate buffing wheels and brushes for polishing acrylic dentures, plastics, and metals. The threads contained on the tapered portion of the chuck's frontal surface secure the buff or brush in position.

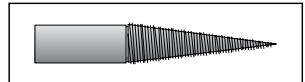

Handler's 8T Jacobs type chucks are made to accommodate from 3/32" to 1/4" burs and mandrels. It is manufactured for gross finishing

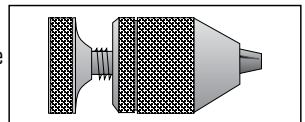

CHUCKS AND CHUCK CHANGERS

Handler's No. 18 Atlas Jacobs type chuck is precision ground to provide excellent concentricity and durability. This chuck will accommodate burs and mandrels from 0" to 1/4" in diameter. Available for right side ONLY.

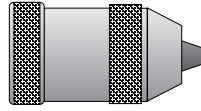

No. 18 Atlas Jacobs

Our No. 9 Arbor band chucks are built to accept 3/4" x 3/4" abrasive bands. These are used for gross finishing of plastics or metals - Right or Left.



No. 9 Arbor band chucks

Handler's No. 1-6 stone chucks are built to accept abrasive stones and lathe wheels with 5/16", 3/8" and 1/4", arbor mountings for the right and left side.

- | | |
|-------------|-------------|
| 1 - 3/8" R | 4 - 5/16" L |
| 2 - 3/8"L | 5 - 1/4" R |
| 3 - 5/16" R | 6 - 1/4" L |



No. 1-6 stone chucks

Note: Specify a No. 20 L or R chuck for a polishing motor with a straight 1/2" shaft.

Handler has designed and built a full line of automatic chucks which will adapt to your Red Wing or other polishing motors. Handler's automatic chucks are durable and built to save processing time and money.

16 CHUK/CHANGER

The Handler Chuk/Changer was designed to provide full automatic, precision changing of 1/4" and 3/32" diameter burs, mandrels and chuck accessories with the slight movement of a handle while the motor is turning.

The Chuk/Changer provides the technician with exacting concentricity and quick, easy changing of various chucks which greatly speeds grinding, polishing and finishing procedures. The No. 16 Chuk/Changer is adaptable to most types of dental motors, including older models e.g. R&M, Ritter, Baldor, Emesco and Red Wing.

NOTE: Specify make, model and catalogue number of lathe when ordering 16L Chuk/Changer is for use on left side of motor.

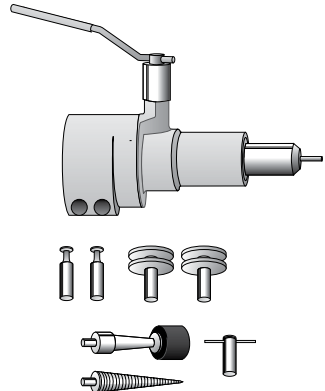

The No. 16 is shipped complete with chuck accessories as follows:

- (1) P-16-15 Arbor Band Chuck
- (1) P-16-16 Spiral Tapered Chuck
- (2) P-16-19 Stone Chucks
- (2) P-16-20 Mandrels - for small abrasive wheels.
- (1) P-16-8 Collet Wrench
- (1) P-16-10 Clutch
- (1) P-16-ADW Adapter

RED WING LATHE PARTS LIST

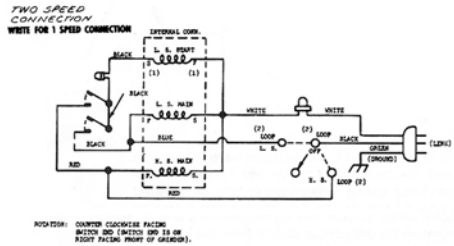
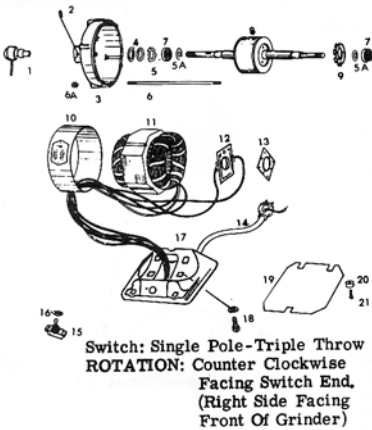

(1) PARTS LIST:

Locate part number on diagram. Specify, on order, identifying part number. Supply all data on nameplate of your Red Wing Lathe - especially the serial number appearing on the last line. (L = Left; R = Right)

PARTS:

- | | | | |
|-------|---------------------------------------------------------------------------|--------|----------------------------------------------------------|
| No.1 | Chuck Remover (Throw Off) - Specify L or R | No.10 | Field Ring - specify whether 1 or 2 speed lathe |
| No.1a | Chuck Remover Male Part - Specify L or R | No.11 | Stator - specify whether 1 or 2 speed lathe |
| No.1b | Chuck Remover Female Part - Specify L or R | No.12 | Hood Switch - specify whether 1 or 2 speed lathe |
| No.1c | Handle for Throw-off | No.13 | Insulating Washer - for hood switch - one speed lathe |
| No.2 | Chuck Remover - set screw for male part | No.14 | Supply Cord - including 2 prong adaptor |
| No.3 | End Bell - one speed - Specify L or R | No.14a | 2 prong adaptor only |
| No.4 | Spacing Washers | No.15 | Switch - two speed (toggle) |
| No.5 | Spring Washers | No.15a | Switch - one speed |
| No.5a | Bearing spacer - one speed - Specify L or R | No.16 | Switch Washer |
| No.6 | Thru-Bolt with nuts | No.17 | Base, Low - 4 1/2" shaft height |
| No.7 | Bearings - two per set - for right and left side - 1- and 2-speed lathes. | No.17a | Base, high - 6" shaft height |
| No.8 | Rotor - specify whether 1 or 2 speed lathe | No.18 | Base Bolts and Washers - low base (4-2 speed, 2-1 speed) |
| No.9 | Centrifugal Switch - specify whether 1 or 2 speed lathe | No.19 | Base Plate |
| | | No.20 | Rubber Base Grommets (set, 4) |
| | | No.21 | Screws for above (set, 4) |
| | | No.22 | Lubri-Plate - 1 3/4 oz tube |

OSHA RECOMMENDED SHIELDS

Handler has designed and built a full line of automatic chucks which will adapt to your Red Wing or other polishing motors. Handler's automatic chucks are durable and built to save processing time and money.

PROTECTIVE SHIELDS AND HOODS

Polishing and Grinding must be completed with the addition of a protective hood with shield or a protective shield, Handler manufactures a full line of protective hoods and shields to protect the technician from possible flying dusts and debris. Below are three examples of the various types available.

The 86D hood shield provides adjustable protection for the technician. Constructed of Ever-brite aluminum, it contains an adjustable 6"x9" clear acrylic shield to help protect the polisher. Hoods are available in 6"x8" and 10" widths. Resin Hoods available in 6" width ONLY.

The protector was designed to provide protection from possible flying debris. Constructed of 3/8" clear acrylic, the protector offers excellent protection for lathe and hand piece grinding.

Protect yourself from UNIDENTIFIED FLYING OBJECTS. The New #26SHLD shield from Handler mounts directly to your lathe. Made of 8" x 6" x 1/8" clear Polycarbonate, fully adjustable, replaceable shield, helps comply with OSHA requirements. Comes with all mounting hardware, Contact your dealer or Handler.

Handler manufactures a full line of protective hoods, shields, and dust collectors. To obtain a Handler catalogue illustrating our hoods, shields, and dust collectors, visit our website at: WWW.HANDLERMFG.COM or call 1-800-27HANDL (1-800-274-2635)



79



86D



26SHLD



**550 PORTA-VAC
HOOD W/ BUILT
IN DUST COLLECTOR**

PARTS AND ACCESSORIES

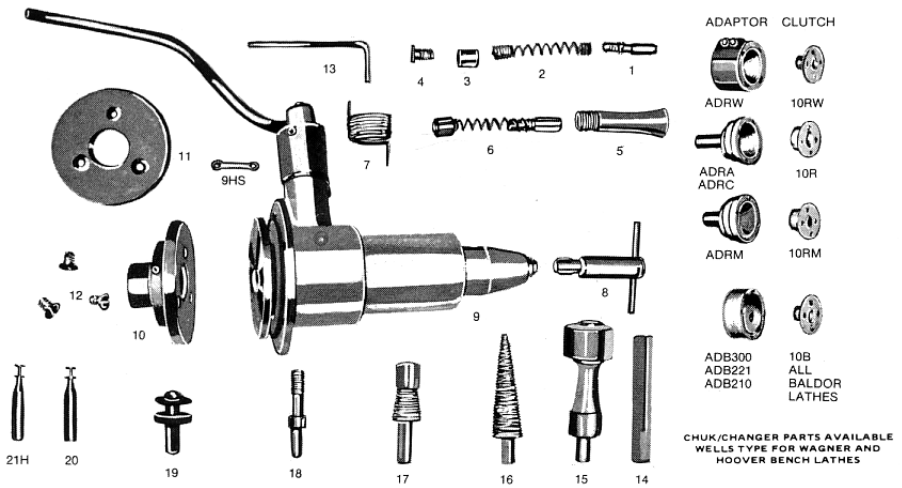

PARTS LIST:

Below is a list of parts and accessories for the RED WING and most other Bench Lathes.

No.1	Special collet for burrs and all 3/32" tools	No.ADRW	Adapter for all Red Wing Lathes
No.1A	A 3/32" burr adapter	No.ADB300	Adapter for all Baldor lathes
No.1B	A 1/8" burr adapter	No.ADB221	Adapter for all Baldor 221-240 series lathes
No.1C	A 3mm burr adapter	No.ADB210	Adapter for all Baldor 210-211 series lathes
No.2	Pop-out spring	No.ADRM	Adapter for all Robbins-Myers lathes
No.3	Stop (state length) .265, .275, .285, .295, .305, .315	No.ADRC	Adapter for all Ritter C lathes
No.3S	Set of 6 stops (one of each length) (use shortest stop possible that will still allow the tools to slip into the master collet) (the life of a worn collet may be extended by using a shorter stop)	No.ADRC	Adapter for all Ritter C lathes
No.4	Stop lock screw	No.ADRA	Adapter for all Ritter A lathes
No.5	Master collet - should be cleaned and lightly greased every 60 days	No.11	Clutch lining
No.6	Special collet, complete with pop-out spring and .275 stop	No.12	Clutch lining screws (set of 3)
No.7	Clutch spring (Note: If Chuk/Changer Wells Type is used on left side, please state for left side)	No.13	3/32" Hex wrench
No.8	Collet wrench	No.14	Sandpaper chuck
No.9H	Handle with plastic cushion grip	No.15	Arbor band chuck 3/4" diameter
No.9HS	Safety strap	No.16	Sprial chuck
No.10RW	Clutch complete for all Red Wing lathes	No.17	Field sandpaper chuck
No.10B	Clutch complete for all Baldor lathes	No.18	Arbor for burrs
No.10RM	Clutch complete with bearing for all Robbins-Myers lathes	No.19	Stone chuck for tooth and knife stones, etc
No.10R	Clutch complete with bearing for all Ritter lathes	No.20	Stainless steel mandrels with 1-64 screw for heatless wheels etc
No.21H	Screw only, 1-64 screw for No.20	No.20S	Screw only, 1-64 screw for No.20
No.21HS	Screw only, 2-64 for No. 21H	No.21H	Stainless steel mandrels with 2/64 screw for 1-1/2" cutoff wheels
No.22	Bearings	No.21HS	Screw only, 2-64 for No. 21H
		No.22	Bearings

IMPORTANT NOTICE

WHAT SHOULD YOU DO TO RETURN GOODS

1. Our terms of sale are F.O.B. our plant. Handler makes every effort to insure the proper delivery of goods, but we cannot guarantee the carrier's performance. Each product is tested and inspected for proper performance prior to leaving our facility. The responsibility for damage in transit is the carrier's, whether it is visible damage or concealed damage.
2. Inspect this shipment IMMEDIATELY. Insist that visible damage or possible damage be written on the Delivery Receipt by the receiver.
3. Inspect the contents of your shipment within 24 hours of receipt. Using your copy of our packing list, check for piece count and accuracy immediately to insure proper billing.
4. If damage is discovered, save all crates, cartons and packaging material until an inspection has been made by an agent of the carrier.
5. In case of damage, notify the delivering carrier IMMEDIATELY requesting that an inspection be made. Retain a copy of the inspection request for claim purposes. Failure to notify the freight carrier immediately will result in the loss of your rights to claim damage.
6. We have taken every precaution to insure safe arrival of your products. We cannot be responsible for negligence by another party.
7. The receiver of the goods must make claims for incorrectly shipped goods to the shipper within 15 days of receipt of delivery.

RETURNING GOODS

1. DO NOT return merchandise without our authorization. You must call first for a return authorization number.
2. We will not accept returned merchandise from the carrier unless our authorization NUMBER has been issued, and is clearly marked on the outside of the carton.
3. We will not accept goods (i.e. dust collectors) that are not cleaned and free of dust and debris. The merchandise will be shipped back. This is in compliance with OSHA regulations.

HANDLER MFG.

612 NORTH AVENUE EAST, WESTFIELD, NEW JERSEY 07090

GROUNDING AND TOOL SAFETY

1. GROUNDING INSTRUCTIONS

This tool should be grounded while in use to protect the operator from electric shock. The tool is equipped with an approved three-conductor cord and three-prong grounding type plug to fit the proper grounding type receptacle. The green (or green and yellow) conductor in the cord is the grounding wire. Never connect the green (or green and yellow) wire to a live terminal. If your unit is for use on less than 150 volts, it has a plug that looks like that shown in sketch (A) in Figure 1. If it is for use on 150 to 250 volts, it has a plug that looks like that shown in sketch (B). Use of an extension cords or a 2 prong adapter is not recommended.

FIGURE 1: GROUNDING METHODS

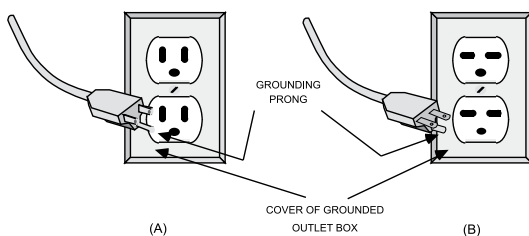

2. TOOL SAFETY INSTRUCTIONS

- 1. Keep Work Area Clean:** Cluttered areas and benches invite accidents.
- 2. Avoid Dangerous Equipment**
Don't expose power tools to rain.
Don't use power tools in damp or wet locations. Keep work area well lit.
- 3. Keep Children Away**
All visitors should be kept safe distance from work area and appliance.
- 4. Store Idle Tools**
When not in use, tools should be stored in dry, high, and locked location out of the reach of children.
- 5. Don't Force Tool**
It will do the job better and be safe at the rate for which it was designed.
- 6. Use Right Tool**
Don't force small tool or attachment to do the job of a heavy-duty tool.
- 7. Wear Proper Apparel**
Do not wear loose clothing or jewelry which may get caught in moving parts. Tie back long hair or use a proper hair net.
- 8. Use Safety Glasses**
Use safety glasses with all rotating tools. Also use a face or dust mask if cutting operation is dusty.
- 9. Don't Abuse Cord**
Never carry tool by cord or yank it to disconnect from receptacle. Keep cord from heat, oil, and sharp edges.
- 10. Secure Work**
Use clamps or a vise to hold work. It's safer than using your hand and it frees both hands to operate tool.
- 11. Don't Overreach**
Keep proper footing and balance at all times.
- 12. Maintain Tools with Care**
Keep tools sharp and clean for best and safest performance. Follow instructions for lubricating and changing accessories.
- 13. Disconnect Tools and TURN OFF.**
When not in use; before servicing; when changing accessories such as blades, bits, cutters, etc.
- 14. Avoid Accidental Starting** this and any other appliance. Be sure switch is OFF when plugging in.

WARRANTY

This HANDLER product is warranted to be free from defects in material and workmanship, when used under the conditions recommended by the manufacturer, and/or the purpose for which the product was intended, for a period of 12 months from the date of shipment from factory to job site of original owner. Products purchased from distributor warehouse stock are warranted for a period of 18 months from date of shipment from the manufacturer's warehouse.

In all cases, the full name and address of the distributor must be supplied, along with the name of the customer, product name and number, and serial number. A copy of the original invoice, showing date of purchase must accompany the warranty repair request.

This warranty will apply to equipment installed, operated and maintained in accordance with HANDLER procedures and recommendations.

During the life of this warranty, HANDLER will repair or replace (At HANDLER's option) free of charge. F.O.B. its plant, any defective part or assembly, if such defect occurred in normal service and was not due to apparent misuse, abuse, or accident.

Any warranty service performed in the field must be authorized by HANDLER MFG. Unauthorized service voids the warranty and any resulting charge will not be paid by HANDLER MFG.

HANDLER MFG. makes no other warranties or guarantees, expressed or implied. The merchantability of the components is expressly excluded. The manufacturer assumes no liability for indirect or consequential damages.

Detach or copy and mail back to the address below.

Customer Name:			
Address:			
City:	State:	Zip:	
Model No.:	Serial No.:		
Distributor:			
Distributor's Address			

Return to HANDLER

HANDLER MFG.
612 NORTH AVENUE EAST, PO BOX 520
WESTFIELD, NEW JERSEY 07090-0520