

## **FMR1510812R, FMR1510824R**

8-Channel, 151MHz Receiver with Relay Outputs

### **Features**

- Wide supply connection – 11.0 to 14.0 Volts AC/DC for FMR1510812R or 21.0 to 28.0 Volts AC/DC for FMR1510824R
- Eight channel receiver with relay outputs
- Low current consumption
- Built-in noise or signal strength indicator
- User can select 8 different frequencies
- Momentary, Latching and Security latching modes are all user selectable
- Easy code setup with dip switch settings

### **Applications**

- Pump Control
- Long distance panic button
- On/Off applications in agricultural devices
- Basic Telemetry eg. Water level indication

### **Description**

This receiver gives you eight relay outputs with a contact rating of 8 amps at 240VAC. The relay mode can be set to momentary, latching or security latching.

The user can select 8 different narrow band frequencies and program unlimited number of transmitters to the receiver. With a narrow band FM 151MHz signal from the transmitter a line of sight operating range of 5000 metres is possible. The receiver uses a crystal oscillator circuit that ensures high frequency stability allowing optimal performance in the receiving range.

### **Case**





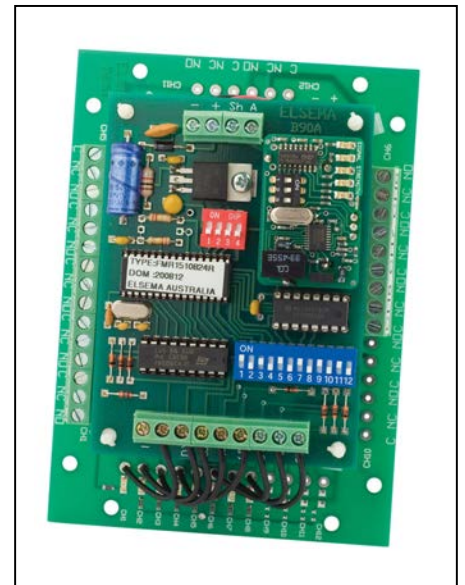



The FMR1510812R, FMR1510824R can be supplied without a case, this allows the receiver to be integrated according to your needs.

The C1217case (weather proof) can be used to enclose the FMR1510812R, FMR1510824R receiver. The receiver with a case is known as FMR1510812RE, FMR1510824RE.



**Different Modes for each Output**

Modes are user selectable from the 4-way dip switch, shown below.

<b>DIP Switch Mode Settings</b>	
The output relay will respond in the following manner when receiving the correct signal from a transmitter	
	"All Momentary": Relay on, only while correct signal is received
	"All Latching": Outputs alternate at every correct incoming signal
	"Momentary & Latching": Outputs 1-4 are momentary & 5-8 are latching
	"Security Latching on": Outputs will be on until supply to receiver is momentarily interrupted
	"Momentary & Latching ": Outputs 1-6 are momentary & 7-8 are latching
	"Momentary & Latching ": Outputs 1-2 are momentary & 3-8 are latching
	"Momentary & Latching ": Outputs 1-3 are momentary & 4-8 are latching
	"Security Latching on": Output 1 is security latching & 2-8 are momentary
	" Security Latching on ": Output 1-7 is latching & 8 is momentary.

**Momentary** - Output is active for as long as the transmitter button is pressed.  
*This is a standard mode on most automatic gates or garage door openers.*

**Latching** - Output remains active until next press of the transmitter button.  
*Similar to switching "on" and "off" a light.*

**Security Latching** - Output remains active until power to the receiver is removed. Similar to security alarms and fire alarms.



**Customised Software**

Custom output modes can be programmed to do special functions. Call Elsema for more details.

**Coding**

The 12 way dip switch on the receiver sets the 12 bit unique code for the system. This has to be matched to that on the transmitter.

## Products in the Range

			
<p><b>FMR15101</b> 1-Channel</p>	<p><b>FMR15102</b> 2-Channel</p>	<p><b>FMR15101240</b> 1- Channel 240VAC Supply</p>	<p><b>FMR15102240</b> 2- Channel 240VAC Supply</p>
			
<p><b>FMR15104</b> 4-Channel</p>	<p><b>FMR15104240</b> 4- Channel 240VAC Supply</p>	<p><b>FMR15108</b> 8-Channel</p>	<p><b>FMR1510812R</b> 8-Channel, 12V Supply</p>
			
<p><b>FMR1510824R</b> 8-Channel, 24V Supply</p>			

**Signal Strength Indicator**

The 151MHz receivers have five blue LED's on the board. The table below indicates the level of the valid transmitted signal.

5 LED's on	-70dBm	Very Strong signal	Very Reliable operating conditions
4 LED's on	-75dBm	Very Strong signal	Very Reliable operating conditions
3 LED's on	-80dBm	Very Strong signal	Very Reliable operating conditions
2 LED's on	-90dBm	Strong signal	Very Reliable operating conditions
1 LED on	-100dBm	Good signal	Reliable operating conditions

**Noise Strength Indicator**

If more than 1 led is "ON" without a valid transmission, this indicates that there is noise on the frequency selected. Change the **3-way dipswitch** on the **receiver module** to select a different frequency. Following is a table with the Dipswitch settings and the corresponding frequencies.

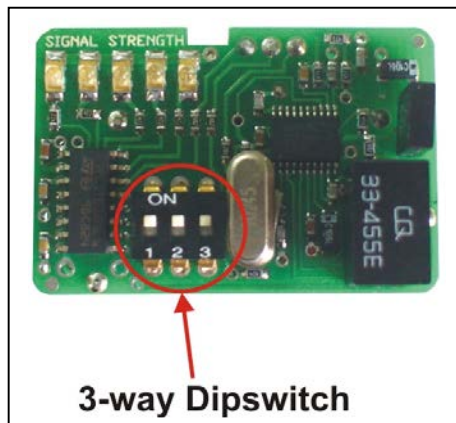

Frequency	1	2	3
151.600 MHz	On	On	On
152.375 MHz	Off	On	On
151.775 MHz	On	Off	On
151.400 MHz	Off	Off	On
151.175MHz	On	On	Off
151.025 MHz	Off	On	Off
150.900 MHz	On	Off	Off
150.825 MHz	Off	Off	Off

**Technical Data**

Supply Voltage	FMR1510812R : 11.0 to 14 V AC/DC Absolute maximum DC 18 Volts FMR1510824R : 21.0 to 28 V AC/DC Absolute maximum DC 35 Volts Can use Elsema AC power pack (12PP or 24PP ) Supply lines should be less than 3 metres long to comply with radio frequency authorities
Current Consumption	22 mA standby, 186mA if all outputs "On"
Receiving Freq	151.6MHz (8 selectable frequencies. See table above)
Operating Temperature	-5 to 50°C
Sensitivity	Better than 0.5uV (For relay to activate)
Type of Demodulation	Narrow-Bandwidth Frequency Modulation (FM)
Relay Contacts	Common (C) Normally Close (NC) and Normally Open (NO)
Connections	Supply, Antenna & Outputs - Screw type terminal block
Antenna	50Ω, 151MHz Antenna, Elsema ANT151M for maximum performance A piece of approximately 1metre wire can be used for short range applications
Dimensions	130 x 94 x 42mm
Mounting hole size	3.97 mm or 5/32"
Weight	240g
Microcontroller	Can be re-programmed to suit your customised needs
Useable Transmitters	All FMT151 series (with correct setting on the dip switch). See Transmitter datasheet for details.
Useable operating range	Up to 5000 metres, depending on installation and type of antenna used. Recommended Antenna is Elsema ANT151M



**Block Diagram**

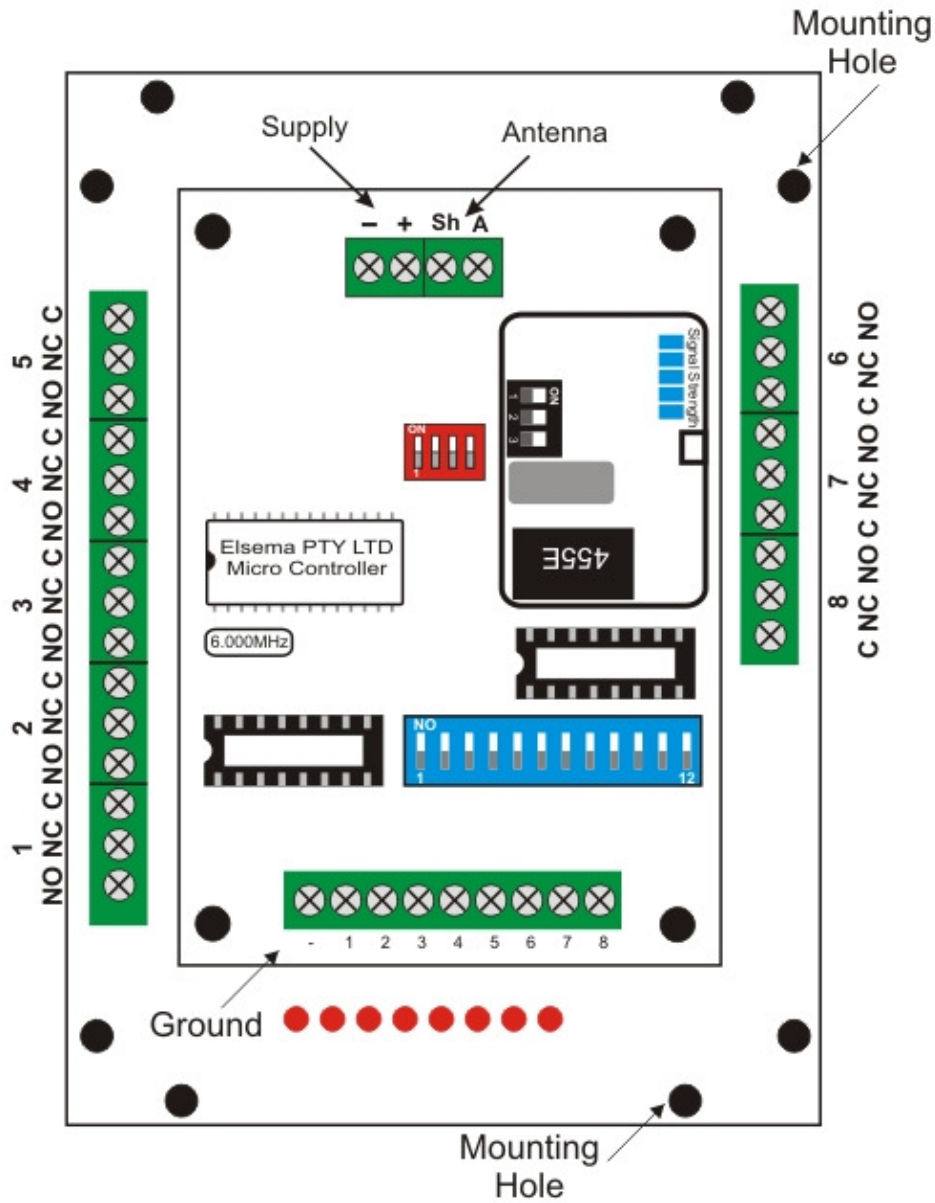

**Manufactured by**  
**Elsema Pty Ltd**  
 31 Tarlington Place, Smithfield  
 NSW 2164  
 Ph: 02 9609 4668  
 Fax: 02 9725 2663  
 Website: <http://www.elsema.com>