

User's Manual



8/16/24-Port 10/100TX 802.3at PoE +
2-Port Gigabit TP/SFP Combo Web
Smart Ethernet Switch

▶ FGSW-1816HPS\FGSD-1008HPS
FGSW-2624HPS\FGSW-2624HPS4



Trademarks

Copyright © PLANET Technology Corp. 2015.

Contents are subject to revision without prior notice.

PLANET is a registered trademark of PLANET Technology Corp. All other trademarks belong to their respective owners.

Disclaimer

PLANET Technology does not warrant that the hardware will work properly in all environments and applications, and makes no warranty and representation, either implied or expressed, with respect to the quality, performance, merchantability, or fitness for a particular purpose. PLANET has made every effort to ensure that this User's Manual is accurate; PLANET disclaims liability for any inaccuracies or omissions that may have occurred.

Information in this User's Manual is subject to change without notice and does not represent a commitment on the part of PLANET. PLANET assumes no responsibility for any inaccuracies that may be contained in this User's Manual. PLANET makes no commitment to update or keep current the information in this User's Manual, and reserves the right to make improvements to this User's Manual and/or to the products described in this User's Manual, at any time without notice.

If you find information in this manual that is incorrect, misleading, or incomplete, we would appreciate your comments and suggestions.

FCC Warning

This equipment has been tested and found to comply with the limits for a Class A digital device, pursuant to Part 15 of the FCC Rules. These limits are designed to provide reasonable protection against harmful interference when the equipment is operated in a commercial environment. This equipment generates, uses, and can radiate radio frequency energy and, if not installed and used in accordance with the Instruction manual, may cause harmful interference to radio communications. Operation of this equipment in a residential area is likely to cause harmful interference in which case the user will be required to correct the interference at his own expense.

CE Mark Warning

This is a Class A product. In a domestic environment, this product may cause radio interference, in which case the user may be required to take adequate measures.

Energy Saving Note of the Device

This power required device does not support Standby mode operation. For energy saving, please remove the power cable to disconnect the device from the power circuit. In view of saving the energy and reducing the unnecessary power consumption, it is strongly suggested to remove the power connection for the device if this device is not intended to be active.

WEEE Warning



To avoid the potential effects on the environment and human health as a result of the presence of hazardous substances in electrical and electronic equipment, end users of electrical and electronic equipment should understand the meaning of the crossed-out wheeled bin symbol. Do not dispose of WEEE as unsorted municipal waste and have to collect such WEEE separately.

Revision

PLANET 8/16/24-Port 10/100TX 802.3at PoE + 2-Port Gigabit TP/SFP Combo Web Smart Ethernet Switch User's Manual

For Models: FGSD-1008HPS / FGSW-1816HPS / FGSW-2624HPS / FGSW-2624HPS4

Revision 1.1 (July 2015)

Part No: 1.1

TABLE OF CONTENTS

1. INTRODUCTION.....	6
1.1 Packet Contents	6
1.2 Product Description	7
1.3 How to Use This Manual	8
1.4 Product Features	9
1.5 Product Specifications	11
2. INSTALLATION	16
2.1 Hardware Description	16
2.1.1 Switch Front Panel	16
2.1.2 LED Indications	17
2.1.3 Switch Rear Panel	21
2.2 Installing the Switch.....	23
2.2.1 Desktop Installation	23
2.2.2 Rack Mounting.....	24
2.2.3 Installing the SFP transceiver	25
3. SWITCH MANAGEMENT	29
3.1 Requirements.....	29
3.2 Management Access Overview.....	30
3.3 Web Management	30
3.4 SNMP-based Network Management	31
3.5 PLANET Smart Discovery Utility	32
4. WEB CONFIGURATION	34
4.1 Main Web Page	36
4.2 System.....	38
4.2.1 System Information.....	38
4.2.2 IP Configurations	39
4.2.3 Password Setting.....	40
4.2.4 Factory Default	40

4.2.5 Firmware Update	41
4.2.6 Reboot	43
4.3 Port Management	44
4.3.1 Port Configuration	44
4.3.2 Port Mirroring	46
4.3.3 Bandwidth Control	48
4.3.4 Broadcast Storm Control	50
4.3.5 Port Statistics	51
4.4 VLAN	53
4.4.1 VLAN Overview	53
4.4.2 VLAN Basic Information	55
4.4.2.1 Port-based VLAN mode	55
4.4.2.2 Tag-based VLAN Mode	55
4.4.3 VLAN Port Configuration	57
4.4.3.1 Port-based VLAN Mode	57
4.4.3.2 Tag-based VLAN Mode	58
4.4.4 Multi to 1 Setting	59
4.5 Quality of Service	60
4.5.1 QoS Overview	60
4.5.2 Priority Mode	61
4.5.3 Class of Service Configuration	61
4.5.4 TCP/UDP Port-based QoS	63
4.6 Security	65
4.6.1 MAC Address Filter	65
4.6.2 TCP/UDP Filter	66
4.7 Spanning Tree	68
4.7.1 STP Bridge Settings	74
4.7.2 STP Port Settings	76
4.8 Trunking Setting	78
4.8.1 Link Aggregation Settings	80
4.9 DHCP Relay Agent	82
4.9.1 DHCP Relay Agent	82
4.9.2 DHCP Relay Server	83
4.9.3 VLAN MAP Relay Agent	84
4.10 PoE Setting	86
4.10.1 Power over Ethernet Powered Device	87

- 4.10.2 PoE Status88
- 4.10.3 PoE Port Setting89
- 4.10.4 Port Sequential91
- 4.11 Configuration Backup / Upload.....93**
- 4.12 Misc Operation94**
- 4.13 SNMP99**
- 4.14 Logout101**
- 5. SWITCH OPERATION 102**
 - 5.1 Address Table102
 - 5.2 Learning102
 - 5.3 Forwarding & Filtering102
 - 5.4 Store-and-Forward102
 - 5.5 Auto-Negotiation103
- 6. Power over Ethernet Overview..... 104**
- 7. TROUBLESHOOTING 106**
- APPENDIX A 107**
 - A.1 Switch's RJ45 Pin Assignments.....107
 - A.2 10/100Mbps, 10/100BASE-TX.....107

1. INTRODUCTION

Thank you for purchasing 8/16/24-Port 10/100TX 802.3at PoE + 2-Port Gigabit TP/SFP Combo Web Smart Ethernet Switch.

The description of this model is shown below:

FGSD-1008HPS	8-Port 10/100TX 802.3at PoE + 2-Port Gigabit TP/ SFP combo Web Smart Switch
FGSW-1816HPS	16-Port 10/100TX 802.3at PoE + 2-Port Gigabit TP/SFP Combo Web Smart Ethernet Switch
FGSW-2624HPS	24-Port 10/100TX 802.3at PoE + 2-Port Gigabit TP/SFP Combo Web Smart Ethernet Switch / 220W
FGSW-2624HPS4	24-Port 10/100TX 802.3at PoE + 2-Port Gigabit TP/SFP Combo Web Smart Ethernet Switch / 420W

“PoE Web Smart Switch” is used as an alternative name in this user’s manual.

1.1 Packet Contents

Open the box of the PoE Web Smart Switch and carefully unpack it. The box should contain the following items:

<input checked="" type="checkbox"/> The PoE Web Smart Switch	x 1
<input checked="" type="checkbox"/> Quick Installation Guide	x 1
<input checked="" type="checkbox"/> SFP Dust Cap	x 2
<input checked="" type="checkbox"/> Rubber Feet	x 4
<input checked="" type="checkbox"/> Rack Mount Accessory Kit	x 1
<input checked="" type="checkbox"/> Power Cord	x 1

If any item is found missing or damaged, please contact your local reseller for replacement.

1.2 Product Description

Ideal Cost-effective Solution for Secure IP Surveillance Infrastructure

Particularly designed for the growing popular IP surveillance applications, PLANET FGSD / FGSW-series PoE Web Smart Ethernet Switch is positioned as a surveillance switch with the central management of remote power control and IP camera monitoring.

Model	FGSD-1008HPS	FGSW-1816HPS	FGSW-2624HPS	FGSW-2624HPS4
10/100TX Copper	8 x RJ45	16 x RJ45	24 x RJ45	24 x RJ45
10/100/1000T Copper	2 x RJ45	2 x RJ45	2 x RJ45	2 x RJ45
1000X Fiber Optic	2 x SFP Slot	2 x SFP Slot	2 x SFP Slot	2 x SFP Slot
PoE+ Ports	8	16	24	24
PoE Budget	125 watts	220 watts	220 watts	420 watts
Enclosure	13" metal case	19" metal case	19" metal case	19" metal case

Centralized Power Management for Security and Public Service PoE Applications

To fulfill the needs of the high power consumption of PoE network applications, the FGSD / FGSW-series PoE Web Smart Switch features the standard **IEEE 802.3at Power over Ethernet Plus (PoE+)** that combines up to 30 watts of power output and data per port over one cat5E/6 Ethernet cable. It is designed specifically to meet the demand of the high power consumption of network PDs (powered devices) such as IR, PTZ, speed dome cameras; and even box-type IP cameras with built-in fan and heater. Compliant with both 802.3at and 802.3af standards, the series allows more flexibility in power requirement for a variety of PDs, making installation costs affordable.

Intelligent LED Indicator for Real-time PoE Usage

The FGSD / FGSW-series PoE Web Smart Switch helps users to monitor the current status of PoE power usage easily and efficiently by its advanced LED indication. Called "**PoE Power Usage**", the front panel of the PoE Web Smart Switch has four orange LEDs indicating PoE power usage.



Robust Layer 2 Features

The FGSD / FGSW-series PoE Web Smart Switch can be programmed for advanced switch management functions such as dynamic port link aggregation (LACP), Spanning Tree Protocol (STP), IGMP Snooping v1, v2, bandwidth control and L2/L4 security control. The PoE Web Smart Switch provides IEEE 802.1Q tagged VLAN, port-based VLAN and MTU VLAN. The VLAN groups are allowed to increase at the maximum of 32. Via aggregation of supporting ports, the PoE Web Smart Ethernet Switch allows the operation of a high-speed trunk combining multiple ports and supports fail-over as well.

Remote and Centralized Management

For catering to the need of easy management and centralized SNMP application to monitor the status of the switch and traffic per port, the FGSD / FGSW-series PoE Web Smart Switch provides friendly Web management interface for efficient network operation. With its built-in Web-based management, the PoE Web Smart Switch offers an easy-to-use, platform-independent management and configuration facility. It also supports standard Simple Network Management Protocol (SNMP) and can be monitored via any standard-based management software.

Flexible and Extendable Uplink Solution

The FGSD / FGSW-series PoE Web Smart Switch provides **2 extra Gigabit TP/SFP combo** interfaces supporting **10/100/1000BASE-T** RJ45 copper to connect with surveillance network devices such as **NVR, Video Streaming Server** or **NAS** to facilitate surveillance management. Or through these dual-speed fiber SFP slots, it can also connect with the **1000BASE-SX/LX** SFP (Small Form-factor Pluggable) fiber transceiver to uplink to backbone switch and monitoring center in long distance. The distance can be extended from 550m to 2km (multi-mode fiber), even going up to above 10/20/30/40/50/70/120km (single-mode fiber or WDM fiber). They are well suited for applications within the enterprise data centers and distributions.

1.3 How to Use This Manual

This User Manual is structured as follows:

Section 2, INSTALLATION

The section explains the functions of the Switch and how to physically install the PoE Web Smart Switch.

Section 3, SWITCH MANAGEMENT

The section contains the information about the software function of the PoE Web Smart Switch.

Section 4, WEB CONFIGURATION

The section explains how to manage the PoE Web Smart Switch by Web interface.

Section 5, SWITCH OPERATION

The chapter explains how to do the switch operation of the PoE Web Smart Switch.

Section 6, Power over Ethernet Overview

The chapter introduces the IEEE 802.3af / 802.3at PoE standard and PoE provision of the PoE Web Smart Switch.

Section 7, TROUBLESHOOTING

The chapter explains how to troubleshoot the PoE Web Smart Switch.

Appendix A

The section contains cable information of the PoE Web Smart Switch.

1.4 Product Features

➤ **Physical Port**

- 8/16/24 10/100BASE-TX RJ45 copper with PoE in-line supported
- 2-port 10/100/1000BASE-T RJ45 copper
- 2 1000BASE-X mini-GBIC/SFP slots to share with Gigabit Ethernet
- Reset button for system management

➤ **Power over Ethernet**

- Complies with IEEE 802.3at High Power over Ethernet End-Span PSE
- Complies with IEEE 802.3af Power over Ethernet End-Span PSE
- Supports PoE Power up to 30.8 watts for each PoE port
- Detects powered device (PD) automatically
- Circuit protection prevents power interference between ports
- Remote power feeding up to 100m
- PoE Power Usage
- PoE Management
 - Per port PoE function enable/disable
 - PoE Port Power feeding priority
 - Per PoE port power limit
 - PD classification detection
 - PoE Power sequential

➤ **Layer 2 Features**

- Auto-MDI/MDI-X detection on each RJ45 port
- Prevents packet loss with back pressure (half-duplex) and IEEE 802.3x pause frame flow control (full-duplex)
- Supports broadcast storm control
- Supports **VLAN**:
 - IEEE 802.1Q tag-based VLAN, up to 32 VLANs groups, out of 4095 VLAN IDs
 - Port-based VLAN, up to 16 VLAN groups
 - MTU VLAN (Multi-tenant Unit VLAN)
- Supports **Link Aggregation**
 - 802.3ad Link Aggregation Control Protocol (LACP)
 - Cisco ether-channel (Static Trunk)
- Supports **Spanning Tree Protocol**
 - STP, IEEE 802.1D Spanning Tree Protocol
 - RSTP, IEEE 802.1w Rapid Spanning Tree Protocol
- Port mirroring to monitor the incoming or outgoing traffic on a particular port
- Provides port mirror (Many-to-1)

➤ **Quality of Service**

- 2 priority queues on all switch ports
- Traffic classification
 - Port-based priority
 - IEEE 802.1p-based priority
 - IP TOS / DSCP-based priority
 - TCP / UDP port-based QoS
- Strict priority and Weighted Round Robin (WRR) CoS policies

➤ **Multicast**

- Supports IGMP Snooping v1 and v2

➤ **Security**

- Physical port to MAC address binding
- TCP/UDP port number filter: Forwarding or discarding typical network applications
- Port mirroring to monitor the incoming or outgoing traffic on a particular port

➤ **Management**

- Switch Management Interfaces
 - Web switch management
 - SNMP v1 switch management
- Supports DHCP Option82 and DHCP Relay
- Firmware upload/download via HTTP
- Hardware reset button for system reboot or reset to factory default
- PLANET smart discovery utility

1.5 Product Specifications

FGSD-1008HPS / FGSW-1816HPS

Product	FGSD-1008HPS	FGSW-1816HPS
Hardware Specifications		
10/100Mbps Copper Ports	8 10/100BASE-TX RJ45 Auto-MDI/MDI-X ports	16 10/100BASE-TX RJ45 Auto-MDI/MDI-X ports
Gigabit Copper Ports	2 10/100/1000BASE-T RJ45 Auto-MDI/MDI-X ports	2 10/100/1000BASE-T RJ45 Auto-MDI/MDI-X ports
SFP/mini-GBIC Slots	2 1000BASE-X SFP interfaces, shared with Port-9 to Port-10	2 1000BASE-X SFP interfaces, shared with Port-17 to Port-18
Switch Architecture	Store-and-Forward	
Switch Fabric	5.6Gbps / non-blocking	7.2Gbps / non-blocking
Throughput	4.16Mpps@64Bytes	5.35Mpps@64Bytes
Address Table	4K entries, automatic source address learning and ageing	
Shared Data Buffer	2.75Mb embedded memory for packet buffers	
Flow Control	IEEE 802.3x pause frame for full-duplex Back pressure for half-duplex	
Maximum Transmit Unit	1536 Bytes	
Reset Button	< 5 sec: System reboot > 5 sec: Factory default	
Dimensions (W x D x H)	330 x 155 x 43.5 mm, 1U height	440 x 200 x 44.5 mm, 1U height
Weight	1.5kg	2.55kg
LED	<p>System: Power (Green)</p> <p>10/100BASE-TX PoE+ RJ45 Interfaces 10/100Mbps LNK/ACT (Green) PoE In-Use (Orange)</p> <p>10/100/1000BASE-T RJ45 / SFP Interfaces LNK/ACT (Green) 100/1000 (Green)</p> <p>PoE Usage 30W, 60W, 90W, 120W (Orange) of FGSD-1008HPS 50W, 100W, 150W, 190W (Orange) of FGSW-1816HPS</p>	
Power Requirements	100~240V AC, 50/60Hz, 2A	
Power Consumption	Max. 150 watts / 511BTU	Max. 240 watts / 816 BTU
ESD Protection	Contact Discharge 8KV DC Air Discharge 8KV DC	4KV DC
Power over Ethernet		
PoE Standard	IEEE 802.3af / 802.3at PoE / PSE	

PoE Power Supply Type		End-span	
PoE Power Output		Per port 52V DC, max. 30.8 watts	
Power Pin Assignment		1/2(+), 3/6(-)	
PoE Power Budget		125 watts (max.)	220 watts (max.)
PoE Ability	PD @ 7 watts	8 units	16 units
	PD @ 15.4 watts	8 units	14 units
	PD @ 30.8 watts	4 units	7 units
Layer 2 Functions			
Port Management		Port disable / enable Auto-negotiation 10/100/1000Mbps full and half duplex mode selection Flow Control disable / enable Bandwidth Control / Broadcast Storm Control	
Port Status		Display each port's speed duplex mode, link status, flow control status, auto negotiation status	
Port Mirroring		TX / RX / Both Many-to-1 monitor	
VLAN		802.1Q tagged-based VLAN, up to 30 VLAN groups, out of 4094 VLAN IDs Port-based VLAN, up to 10 / 18VLAN groups MTU VLAN	
QoS		Allow to assign low / high priority on each port First-In-First-Out, All-High-before-Low, Weight-Round-Robin QoS policy	
Security Control		MAC address binding TCP & UDP Filter	
Spanning Tree Protocol		STP, IEEE 802.1D Spanning Tree Protocol RSTP, IEEE 802.1w Rapid Spanning Tree Protocol	
Link Aggregation		1 group of 2-Port 10/100/1000BASE-T trunk supported	
DHCP Relay		DHCP Relay Agent / DHCP Relay Server	
PoE Setting		PoE Status / PoE Port Setting / PoE Sequential / PoE Schedule	
Configuration Back / Restore		Configuration backup / restore through Web interface	
IGMP Snooping		IGMP (v1 / v2) Snooping, up to 32 multicast groups	
Management Functions			
Basic Management Interfaces		Web browser, SNMP v1 / v2c	
Standards Conformances			
Regulation Compliance		FCC Part 15 Class A, CE	
Standards Compliance		IEEE 802.3 Ethernet IEEE 802.3u Fast Ethernet IEEE 802.3ab Gigabit Ethernet IEEE 802.3z Gigabit Ethernet IEEE 802.3x Full-duplex flow control IEEE 802.1Q VLAN	

		IEEE 802.1p QoS IEEE 802.1D Spanning Tree Protocol IEEE 802.1w Rapid Spanning Tree Protocol IEEE 802.3af Power over Ethernet IEEE 802.3at Power over Ethernet Plus
Cable	Twisted-Pair	10BASE-T: 2-pair UTP Cat 3, 4, 5, up to 100 meters 100BASE-TX: 2-pair UTP Cat 5, 5e up to 100 meters 1000BASE-T: 4-pair UTP Cat 5e, 6 up to 100 meters
	Fiber-Optic Cable	1000BASE-SX : 50/125µm or 62.5/125µm multi-mode fiber optic cable, up to 550m (varying on SFP module) 1000BASE-LX : 9/125µm single-mode fiber optic cable, up to 10/20/30/40/50/60/70/120 kilometers (varying on SFP module)
Environment		
Operating	Temperature:	0 ~ 50 degrees C Relative Humidity: 5 ~ 95% (non-condensing)
Storage	Temperature:	-10 ~ 70 degrees C Relative Humidity: 5 ~ 95% (non-condensing)

FGSW-2624HPS / FGSW-2624HPS4

Product	FGSW-2624HPS	FGSW-2624HPS4
Hardware Specifications		
10/100Mbps Copper Ports	24 10/100BASE-TX RJ45 Auto-MDI/MDI-X ports	
Gigabit Copper Ports	2 10/100/1000BASE-T RJ45 Auto-MDI/MDI-X ports	
SFP/mini-GBIC Slots	2 1000BASE-X SFP interfaces, shared with Port-25 to Port-26	
Switch Architecture	Store-and-Forward	
Switch Fabric	8.8Gbps / non-blocking	
Throughput	6.54Mpps@64 bytes	
Address Table	4K entries, automatic source address learning and ageing	
Shared Data Buffer	2.75Mb embedded memory for packet buffers	
Flow Control	IEEE 802.3x pause frame for full-duplex Back pressure for half-duplex	
Maximum Transmit Unit	1518 bytes	
Reset Button	< 5 sec: System reboot > 5 sec: Factory default	
Dimensions (W x D x H)	440 x 300 x 44.5 mm, 1U height	
Weight	FGSW-2624HPS: TBD kg FGSW-2624HPS4: TBD kg	

LED	<p>System: Power (Green)</p> <p>10/100BASE-TX RJ45 Interfaces (Port1 to Port24): 10/100Mbps LNK/ACT (Green) PoE In-Use (Orange)</p> <p>10/100/1000BASE-T RJ45 / SFP Interfaces (Port25 to Port26): LNK/ACT (Green) 100/1000 (Green)</p> <p>PoE Usage 50W, 100W, 150W, 190W (Orange) of FGSW-2624HPS 100W, 200W, 300W, 350W (Orange) of FGSW-2624HPS4</p>		
Power Requirements	<p>FGSW-2624HPS: 100~240V AC, 50/60Hz, 4A FGSW-2624HPS4: 100~240V AC, 50/60Hz, 4A</p>		
Power Consumption	<p>FGSW-2624HPS: Max. TBD watts / TBD BTU FGSW-2624HPS4: Max. TBD watts / TBD BTU</p>		
ESD Protection	6KV DC		
Power over Ethernet			
PoE Standard	IEEE 802.3af / 802.3at PoE / PSE		
PoE Power Supply Type	End-span		
PoE Power Output	Per Port 56V DC, Max. 30.8 watts		
Power Pin Assignment	1/2(+), 3/6(-)		
PoE Power Budget	220 watts (max.) @ 25 degrees C	440 watts (max.) @ 25 degrees C	
	190 watts (max.) @ 50 degrees C	380 watts (max.) @ 50 degrees C	
PoE Ability	PD @ 7 watts	24 units	24 units
	PD @ 15.4 watts	14 units	24 units
	PD @ 30.8 watts	7 units	14 units
Layer 2 Functions			
Port Configuration	<p>Port disable / enable Auto-negotiation 10/100/1000Mbps full and half duplex mode selection Flow Control disable / enable</p>		
Port Status	Display each port's speed duplex mode, link status, flow control status, auto negotiation status and trunk status		
Port Mirroring	<p>TX / RX / Both Many-to-1 monitor</p>		
VLAN	<p>802.1Q tagged-based VLAN, up to 30 VLAN groups, out of 4094 VLAN IDs Port-based VLAN, up to 18 VLAN groups MTU VLAN</p>		
Link Aggregation	1 group of 2-Port 10/100/1000BASE-T trunk supported		
QoS	<p>Allows to assign low / high priority on each port First-In-First-Out, All-High-before-Low, Weight-Round-Robin QoS policy</p>		
IGMP Snooping	IGMP (v1/v2) Snooping, up to 32 multicast groups		

		Without Query supported
Security Control		MAC address binding TCP & UDP filter
Management Functions		
Basic Management Interfaces		Web browser, SNMP v1
Standards Conformances		
Regulation Compliance		FCC Part 15 Class A, CE
Standards Compliance		IEEE 802.3 Ethernet IEEE 802.3u Fast Ethernet IEEE 802.3ab Gigabit Ethernet IEEE 802.3z Gigabit Ethernet over fiber-optic IEEE 802.3x Full-duplex flow control IEEE 802.1Q VLAN IEEE 802.1p QoS IEEE 802.1D Spanning Tree Protocol IEEE 802.1w Rapid Spanning Tree Protocol IEEE 802.3af Power over Ethernet IEEE 802.3at Power over Ethernet Plus
Cable	Twisted-Pair	10BASE-T: 2-pair UTP Cat 3, 4, 5, up to 100 meters 100BASE-TX: 2-pair UTP Cat 5, 5e, up to 100 meters 1000BASE-T: 4-pair UTP Cat 5e, 6, up to 100 meters
	Fiber-Optic Cable	1000BASE-SX : 50/125µm or 62.5/125µm multi-mode fiber optic cable, up to 550m (varying on SFP module) 1000BASE-LX : 9/125µm single-mode fiber optic cable, up to 10/20/30/40/50/60/70/120 kilometers (varying on SFP module)
Environment		
Operating	Temperature:	0 ~ 50 degrees C
	Relative Humidity:	5 ~ 95% (non-condensing)
Storage	Temperature:	-10 ~ 70 degrees C
	Relative Humidity:	5 ~ 95% (non-condensing)

2. INSTALLATION

This section describes the hardware features and installation of the PoE Web Smart Switch on the desktop or rack mount. For easier management and control of the PoE Web Smart Switch, familiarize yourself with its display indicators, and ports. Front panel illustrations in this chapter display the unit LED indicators. Before connecting any network device to the PoE Web Smart Switch, please read this chapter completely.

2.1 Hardware Description

2.1.1 Switch Front Panel

The front panel provides a simple interface monitoring the PoE Web Smart Switch. [Figures 2-1-A ~ 2-1-D](#) show the front panel.

FGSD-1008HPS



Figure 2-1-A FGSD-1008HPS front panel

FGSW-1816HPS



Figure 2-1-B FGSW-1816HPS front panel

FGSW-2624HPS



Figure 2-1-C FGSW-2624HPS front panel

FGSW-2624HPS4



Figure 2-1-D FGSW-2624HPS4 front panel

■ Fast Ethernet TP interface

10/100BASE-TX Copper, RJ45 Twisted-pair: up to 100 meters.

■ Gigabit TP Interface

10/100/1000BASE-T Copper, RJ45 Twisted-pair: up to 100 meters.

■ **Gigabit SFP Slots**

1000BASE-SX/LX mini-GBIC slot, SFP (Small Factor Pluggable) transceiver module: From 550 meters (Multi-mode fiber), up to 10/20/30/40/50/60/70/120 kilometers (Single-mode fiber).

■ **Reset Button**

On the left side of the front panel, the reset button is designed for rebooting the PoE Web Smart Switch without turning off and on the power. The following is the summary table of Reset button functions:

Reset Button Pressed and Released	Function
< 5 sec: System Reboot	Reboot the PoE Web Smart Switch.
> 5 sec: Factory Default	Reset the PoE Web Smart Switch to Factory Default configuration. The PoE Web Smart Switch will then reboot and load the default settings as shown below: <ul style="list-style-type: none"> ■ Default Username: admin ■ Default Password: admin ■ Default IP address: 192.168.0.100 ■ Subnet mask: 255.255.255.0 ■ Default Gateway: 192.168.0.254

2.1.2 LED Indications

The front panel LEDs indicate instant status of port links, data activity and system power, and help monitor and troubleshoot when needed. Figures 2-2-A ~ 2-2-D show the LED indications of these PoE Web Smart Switches.

FGSD-1008HPS LED Indication

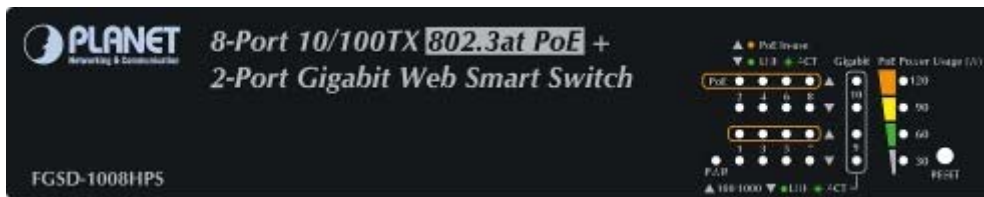

Figure 2-2-A FGSD-1008HPS LED panel

■ **System**

LED	Color	Function
PWR	Green	Lights to indicate that the Switch has power.

■ **Per 10/100Mbps Port with PoE Interfaces (Port1 to Port8)**

LED	Color	Function
LNK/ACT	Green	Lights: Indicates the link through that port is successfully established at 10/100Mbps.
		Blinks: Indicates that the Switch is actively sending or receiving data over that port.
PoE In-Use	Orange	Lights: Indicates the port is providing 52V DC in-line power.
		Off: Indicates the connected device is not a PoE Powered Device (PD).

■ Per 10/100/1000Mbps RJ-45 Combo Interface (Port9 to Port10)

LED	Color	Function	
LNK/ACT	Green	Lights:	Indicates the port is successfully established.
		Blinks:	Indicates that the Switch is actively sending or receiving data over that port.
10/100/1000	Green	Lights:	Indicates the port is successfully established at 1000Mbps.
		Slow Blinks:	Indicates the port is successfully established at 100Mbps.
		Off:	Indicates the port is successfully established at 10Mbps.

■ Per 1000Mbps SFP Combo Interface (Port9 to Port10)

LED	Color	Function	
LNK/ACT	Green	Lights	Indicates that the Switch is actively sending or receiving data over that port.
1000	Green	Lights	Indicates the port is successfully established at 1000Mbps.

■ PoE Usage

LED	Color	Function	
30W	Orange	Lights to indicate the PoE power consumption has 30W or over.	
60W	Orange	Lights to indicate the PoE power consumption has 60W or over.	
90W	Orange	Lights to indicate the PoE power consumption has 90W or over.	
120W	Orange	Lights to indicate the PoE power consumption has 120W or over.	

FGSW-1816HPS LED Indication

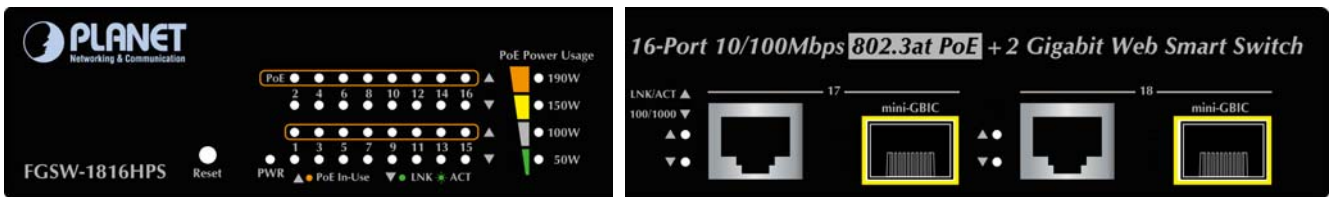

Figure 2-2-B FGSW-1816HPS LED panel

➤ System

LED	Color	Function	
PWR	Green	Lights to indicate that the Switch has power.	

➤ Per 10/100Mbps port with PoE interfaces (Port-1 to Port-16)

LED	Color	Function	
LNK/ACT	Green	Lights:	Indicates the link through that port is successfully established at 10/100Mbps.
		Blinks:	Indicates that the Switch is actively sending or receiving data over that port.
PoE In-Use	Orange	Lights:	Indicates the port is providing 52V DC in-line power.
		Off:	Indicates the connected device is not a PoE Powered Device (PD).

➤ Per 10/100/1000Mbps RJ45 Combo Interface (Port-17 to Port-18)

LED	Color	Function	
LNK/ACT	Green	Blinks:	Indicates that the Switch is actively sending or receiving data over that port.
100/1000	Green	Lights.	Indicates the port is successfully established at 1000Mbps.
		Slow Blink:	Indicates the port is successfully established at 100Mbps.
		Off:	Indicates the port is successfully established at 10Mbps.

➤ Per 1000Mbps SFP Combo Interface (Port-17 to Port-18)

LED	Color	Function	
LNK/ACT	Green	Blinks:	Indicates that the Switch is actively sending or receiving data over that port.
1000	Green	Lights.	Indicates the port is successfully established at 1000Mbps.

➤ PoE Usage

LED	Color	Function	
50W	Orange	Lights to indicate the PoE power consumption has equal 50W or over 50W.	
100W	Orange	Lights to indicate the PoE power consumption has equal 100W or over 100W.	
150W	Orange	Lights to indicate the PoE power consumption has equal 150W or over 150W.	
190W	Orange	Lights to indicate the PoE power consumption has equal 190W or over 190W.	

FGSW-2624HPS / FGSW-2624HPS4 LED Indication

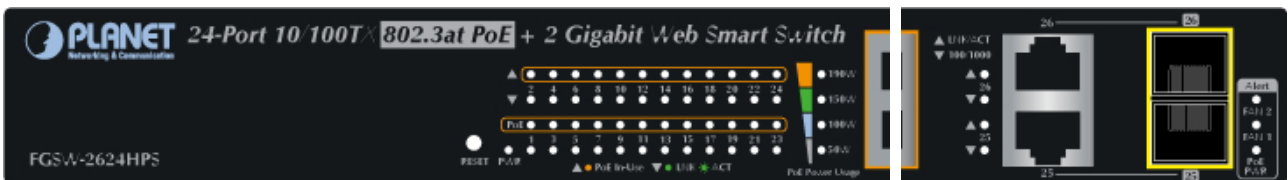

Figure 2-2-C FGSW-2624HPS LED panel



Figure 2-2-D FGSW-2624HPS4 LED panel

➤ System / Alarm

LED	Color	Function	
PWR	Green	Lights to indicate that the Switch has power.	
PoE PWR	Red	Lights to indicate that PoE power is error.	

FAN1	Red	Lights to indicate that FAN1 is error.
FAN2	Red	Lights to indicate that FAN2 is error.

➤ Per 10/100Mbps port with PoE interfaces (Port-1 to Port-24)

LED	Color	Function	
LNK/ACT	Green	Lights:	Indicates the link through that port is successfully established at 10/100Mbps.
		Blinks:	Indicates that the Switch is actively sending or receiving data over that port.
PoE In-Use	Orange	Lights:	Indicates the port is providing DC in-line power.
		Off:	Indicates the connected device is not a PoE Powered Device (PD).

➤ Per 10/100/1000Mbps RJ45 Combo Interface (Port-25 to Port-26)

LED	Color	Function	
LNK/ACT	Green	Lights.	Indicates the port is successfully established.
		Blinks:	Indicates that the Switch is actively sending or receiving data over that port.
100/1000	Green	Lights.	Indicates the port is successfully established at 1000Mbps.
		Slow Blinks:	Indicates the port is successfully established at 100Mbps.
		Off:	Indicates the port is successfully established at 10Mbps.

➤ Per 1000Mbps SFP Combo Interface (Port-25 to Port-26)

LED	Color	Function	
LNK/ACT	Green	Lights.	Indicates that the Switch is actively sending or receiving data over that port.
1000	Green	Lights.	Indicates the port is successfully established at 1000Mbps.

➤ PoE Usage

Model	LED	Color	Function
FGSW-2624HPS	50W	Orange	Lights to indicate the PoE power consumption has equal 50W or over 50W.
	100W	Orange	Lights to indicate the PoE power consumption has equal 100W or over 100W.
	150W	Orange	Lights to indicate the PoE power consumption has equal 150W or over 150W.
	190W	Orange	Lights to indicate the PoE power consumption has equal 190W or over 190W.
FGSW-2624HPS4	100W	Orange	Lights to indicate the PoE power consumption has equal 100W or over 100W.
	200W	Orange	Lights to indicate the PoE power consumption has equal 200W or over 200W.
	300W	Orange	Lights to indicate the PoE power consumption has equal 300W or over 300W.
	400W	Orange	Lights to indicate the PoE power consumption has equal 400W or over 400W.

2.1.3 Switch Rear Panel

The rear panel of the PoE Web Smart Switch indicates a DC inlet power socket. [Figures 2-3-A ~2-3-D](#) show the rear panel of these PoE Web Smart Switches

FGSD-1008HPS



Figure 2-3-A Rear panel of FGSD-1008HPS

FGSW-1816HPS



Figure 2-3-B Rear panel of FGSW-1816HPS

FGSW-2624HPS



Figure 2-3-C Rear panel of FGSW-2624HPS

FGSW-2624HPS4



Figure 2-3-D Rear panel of FGSW-2624HPS4

■ AC Power Receptacle

For compatibility with electric service in most areas of the world, the PoE Web Smart Switch's power supply automatically adjusts to line power in the range of 100-240V AC and 50/60 Hz.

Plug the female end of the power cord firmly into the receptacle on the rear panel of the PoE Web Smart Switch. Plug the other end of the power cord into an electric service outlet and the power will be ready.

The device is a power-required device, which means it will not work till it is powered. If your networks should be active all the time, please consider using UPS (Uninterrupted Power Supply) for your device.

Power Notice: It will prevent you from network data loss or network downtime. In some areas, installing a surge suppression device may also help to protect your PoE Web Smart Switch from being damaged by unregulated surge or current to the Switch or the power adapter.

2.2 Installing the Switch

This section describes how to install your PoE Web Smart Switch and make connections to the PoE Web Smart Switch. Please read the following topics and perform the procedures in the order being presented. To install your PoE Web Smart Switch on a desktop or shelf, simply complete the following steps.



Because FGSD-1008HPS and FGSW-2624HPS4 installation methods are the same as FGSW-1816HPS, FGSW-1816HPS is picked as an example.

2.2.1 Desktop Installation

To install the PoE Web Smart Switch on desktop or shelf, please follow these steps:

Step 1: Attach the rubber feet to the recessed areas on the bottom of the PoE Web Smart Switch.

Step 2: Place the PoE Web Smart Switch on the desktop or the shelf near a DC or PoE-in power source, as shown in [Figure 2-4](#).

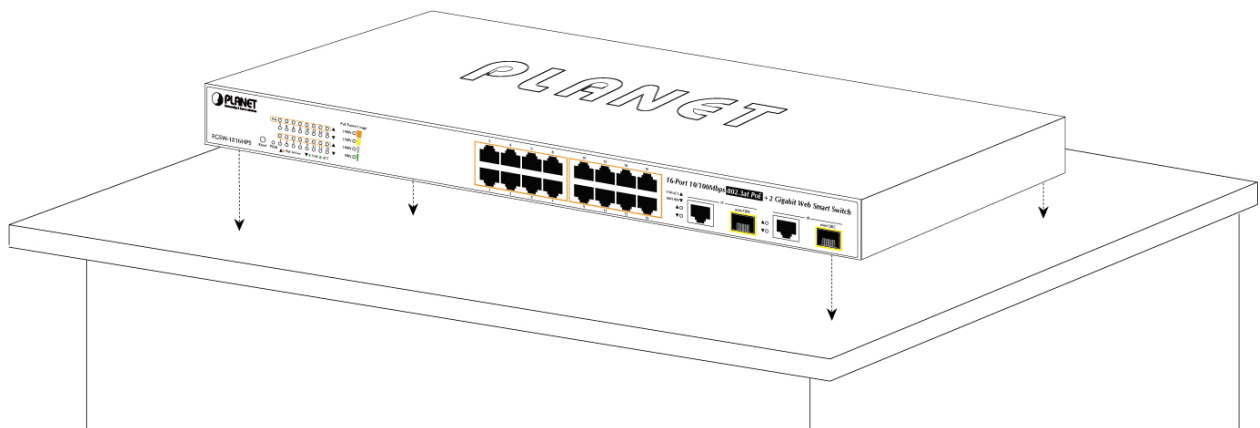

Figure 2-4 Place the PoE Web Smart Switch on the desktop

Step 3: Keep enough ventilation space between the PoE Web Smart Switch and the surrounding objects.



When choosing a location, please keep in mind the environmental restrictions discussed in Chapter 1, Section 4 under specifications.

Step 4: Connect the PoE Web Smart Switch to network devices.

Connect one end of a standard network cable to the 10/100/1000 RJ45 ports on the front of the PoE Web Smart Switch. Connect the other end of the cable to the network devices such as printer server, workstation or router.



Connection to the PoE Web Smart Switch requires UTP Category 5 network cabling with RJ45 tips. For more information, please see the Cabling Specifications in Appendix A.

Step 5: Supply power to the PoE Web Smart Switch.

Connect one end of the power cable to the PoE Web Smart Switch.

Connect the power plug of the power cable to a standard wall outlet.

When the PoE Web Smart Switch receives power, the Power LED should remain solid Green.

2.2.2 Rack Mounting

To install the PoE Web Smart Switch in a 19-inch standard rack, please follow the instructions described below.

Step 1: Place the PoE Web Smart Switch on a hard flat surface, with the front panel positioned towards the front side.

Step 2: Attach the rack-mount bracket to each side of the PoE Web Smart Switch with supplied screws attached to the package.

Figure 2-5 shows how to attach brackets to one side of the PoE Web Smart Switch.

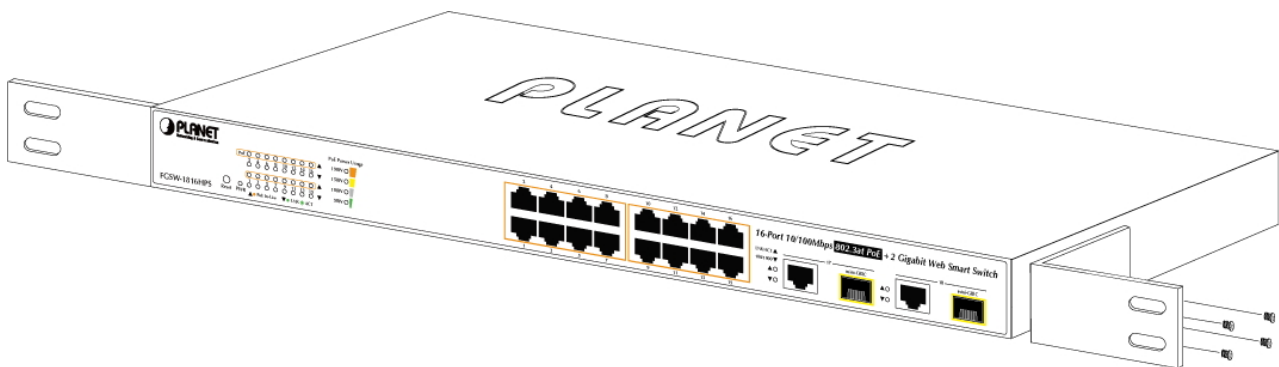

Figure 2-5 Attach Brackets to the PoE Web Smart Switch.



You must use the screws supplied with the mounting brackets. Damage caused to the parts by using incorrect screws would invalidate the warranty.

Step 3: Secure the brackets tightly.

Step 4: Follow the same steps to attach the second bracket to the opposite side.

Step 5: After the brackets are attached to the PoE Web Smart Switch, use suitable screws to securely attach the brackets to the rack, as shown in Figure 2-6.

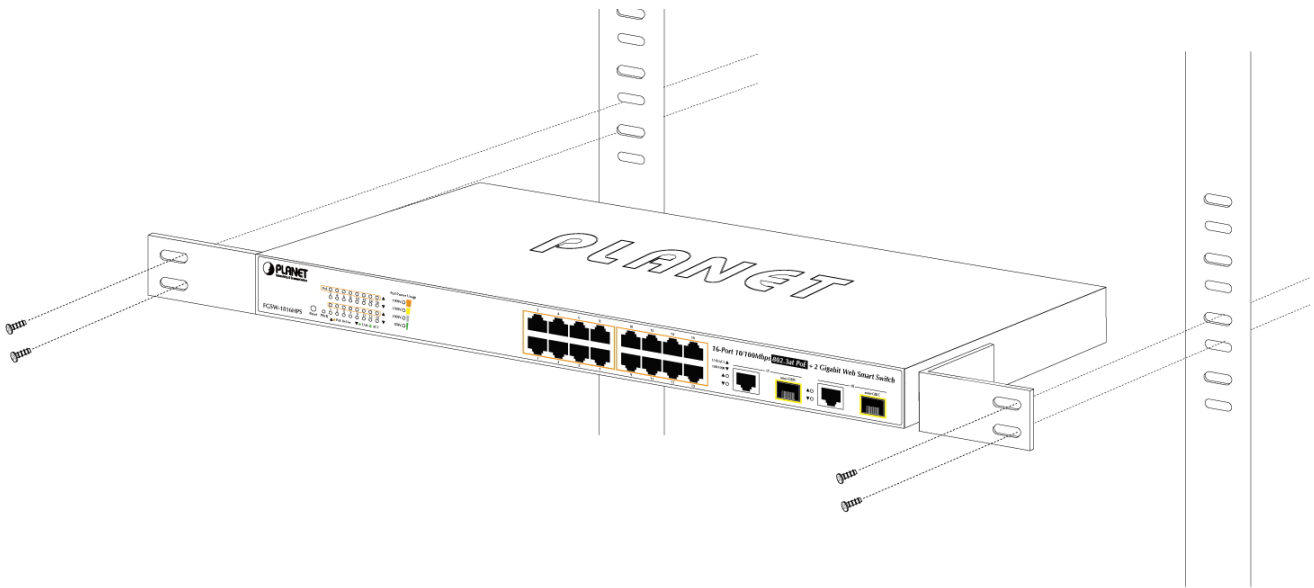

Figure 2-6 Mounting PoE Web Smart Switch in a Rack

Step 6: Proceed with steps 4 and 5 of session 2.2.1 Desktop Installation to connect the network cabling and supply power to the PoE Web Smart Switch.

2.2.3 Installing the SFP transceiver

The sections describe how to insert an SFP transceiver into an SFP slot. The SFP transceivers are hot-pluggable and hot-swappable. You can plug in and out the transceiver to/from any SFP port without having to power down the PoE Web Smart Switch, as the Figure 2-7 shows.



Figure 2-7 Plug in the SFP transceiver

■ Approved PLANET SFP Transceivers

PLANET PoE Web Smart Switch supports both single mode and multi-mode SFP transceiver. The following list of approved PLANET SFP transceivers is correct at the time of publication:

Gigabit Ethernet Transceiver (1000BASE-X SFP)

Model	Speed (Mbps)	Connector Interface	Fiber Mode	Distance	Wavelength (nm)	Operating Temp.
MGB-GT	1000	Copper	--	100m	--	0 ~ 60 °C
MGB-SX	1000	LC	Multi Mode	550m	850nm	0 ~ 60 °C
MGB-SX2	1000	LC	Multi Mode	2km	1310nm	0 ~ 60 °C
MGB-LX	1000	LC	Single Mode	10km	1310nm	0 ~ 60 °C
MGB-L30	1000	LC	Single Mode	30km	1310nm	0 ~ 60 °C
MGB-L50	1000	LC	Single Mode	50km	1550nm	0 ~ 60 °C
MGB-L70	1000	LC	Single Mode	70km	1550nm	0 ~ 60 °C
MGB-L120	1000	LC	Single Mode	120km	1550nm	0 ~ 60 °C
MGB-TSX	1000	LC	Multi Mode	550m	850nm	-40 ~ 75 °C
MGB-TLX	1000	LC	Single Mode	10km	1310nm	-40 ~ 75 °C
MGB-TL30	1000	LC	Single Mode	30km	1310nm	-40 ~ 75 °C
MGB-TL70	1000	LC	Single Mode	70km	1550nm	-40 ~ 75 °C

Gigabit Ethernet Transceiver (1000BASE-BX, Single Fiber Bi-Directional SFP)

Model	Speed (Mbps)	Connector Interface	Fiber Mode	Distance	Wavelength (TX)	Wavelength (RX)	Operating Temp.
MGB-LA10	1000	WDM(LC)	Single Mode	10km	1310nm	1550nm	0 ~ 60 °C
MGB-LB10	1000	WDM(LC)	Single Mode	10km	1550nm	1310nm	0 ~ 60 °C
MGB-LA20	1000	WDM(LC)	Single Mode	20km	1310nm	1550nm	0 ~ 60 °C
MGB-LB20	1000	WDM(LC)	Single Mode	20km	1550nm	1310nm	0 ~ 60 °C
MGB-LA40	1000	WDM(LC)	Single Mode	40km	1310nm	1550nm	0 ~ 60 °C
MGB-LB40	1000	WDM(LC)	Single Mode	40km	1550nm	1310nm	0 ~ 60 °C
MGB-LA60	1000	WDM(LC)	Single Mode	60km	1310nm	1550nm	0 ~ 60 °C
MGB-LB60	1000	WDM(LC)	Single Mode	60km	1550nm	1310nm	0 ~ 60 °C
MGB-TLA10	1000	WDM(LC)	Single Mode	10km	1310nm	1550nm	-40 ~ 75 °C
MGB-TLB10	1000	WDM(LC)	Single Mode	10km	1550nm	1310nm	-40 ~ 75 °C
MGB-TLA20	1000	WDM(LC)	Single Mode	20km	1310nm	1550nm	-40 ~ 75 °C
MGB-TLB20	1000	WDM(LC)	Single Mode	20km	1550nm	1310nm	-40 ~ 75 °C
MGB-TLA40	1000	WDM(LC)	Single Mode	40km	1310nm	1550nm	-40 ~ 75 °C
MGB-TLB40	1000	WDM(LC)	Single Mode	40km	1550nm	1310nm	-40 ~ 75 °C
MGB-TLA60	1000	WDM(LC)	Single Mode	60km	1310nm	1550nm	-40 ~ 75 °C
MGB-TLB60	1000	WDM(LC)	Single Mode	60km	1550nm	1310nm	-40 ~ 75 °C



It is recommended to use PLANET SFP on the PoE Web Smart Switch. If you insert an SFP transceiver that is not supported, the PoE Web Smart Switch will not recognize it.

1. Before we connect PoE Web Smart Switch to the other network device, we have to make sure both sides of the SFP transceivers are with the same media type, for example, 1000BASE-SX to 1000BASE-SX, 1000Bas-LX to 1000BASE-LX.
2. Check whether the fiber-optic cable type matches with the SFP transceiver requirement.
 - To connect to 1000BASE-SX SFP transceiver, please use the multi-mode fiber cable with one side being the male duplex LC connector type.
 - To connect to 1000BASE-LX SFP transceiver, please use the single-mode fiber cable with one side being the male duplex LC connector type.

■ Connect the Fiber Cable

1. Insert the duplex LC connector into the SFP transceiver.
2. Connect the other end of the cable to a device with SFP transceiver installed.
3. Check the LNK/ACT LED of the SFP slot on the front of the PoE Web Smart Switch. Ensure that the SFP transceiver is operating correctly.
4. Check the Link mode of the SFP port if the link fails. To function with some fiber-NICs or Media Converters, user has to set the port Link mode to “**1000 Force**”.

■ Remove the Transceiver Module

1. Make sure there is no network activity anymore.
2. Remove the Fiber-Optic Cable gently.
3. Lift up the lever of the MGB module and turn it to a horizontal position.
4. Pull out the module gently through the lever.

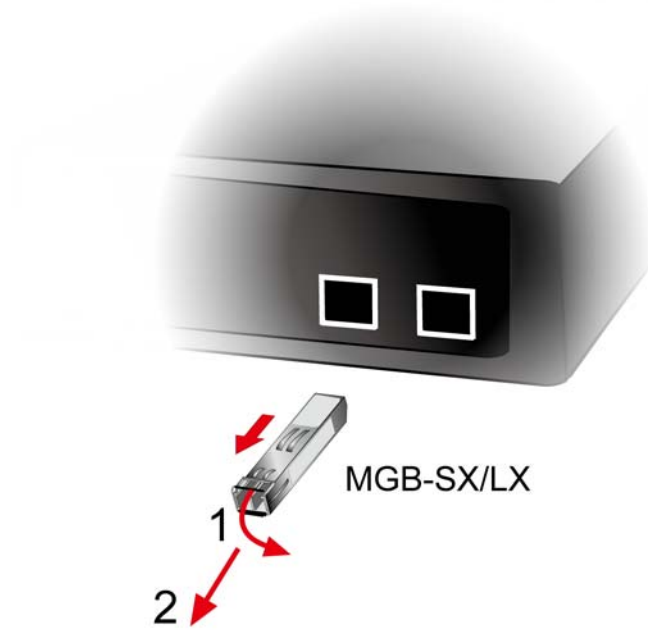

Figure 2-8 How to Pull Out the SFP Transceiver



Never pull out the module without lifting up the lever of the module and turning it to a horizontal position. Directly pulling out the module could damage the module and the SFP module slot of the PoE Web Smart Switch.

3. SWITCH MANAGEMENT

This chapter explains the methods that you can use to configure management access to the PoE Web Smart Switch. It describes the types of management applications and the communication and management protocols that deliver data between your management device (workstation or personal computer) and the system. It also contains information about port connection options.

This chapter covers the following topics:

- Requirements
- Management Access Overview
- Web Management Access
- SNMP Access
- Standards, Protocols, and Related Readings

3.1 Requirements

- **Workstations** running Windows 2000/XP, 2003, Vista/7/8, 2008, MAC OS9 or later, Linux, UNIX or other platforms are compatible with **TCP/IP** protocols.
- **Workstation** is installed with **Ethernet NIC** (Network Interface Card)
- Ethernet Port connection
 - Network cables -- Use standard network (UTP) cables with RJ45 connectors.
- The above Workstation is installed with **Web browser** and **JAVA runtime environment** plug-in



It is recommended to use Internet Explorer 8.0 or above to access PoE Web Smart Switch.

3.2 Management Access Overview

The PoE Web Smart Switch gives you the flexibility to access and manage it using any or all of the following methods:

- **Web browser** interface
- An external **SNMP-based network management application**

The Web browser management is embedded in the PoE Web Smart Switch software and available for immediate use. Each of these management methods has their own advantages. Table 3-1 compares the three management methods.

Method	Advantages	Disadvantages
Web Browser	<ul style="list-style-type: none"> ■ Ideal for configuring the switch remotely ■ Compatible with all popular browsers ■ Can be accessed from any location ■ Most visually appealing 	<ul style="list-style-type: none"> ■ Security can be compromised (hackers need to know only the IP address and subnet mask) ■ May encounter lag times on poor connections
SNMP Agent	<ul style="list-style-type: none"> ■ Communicates with switch functions at the MIB level ■ Based on open standards 	<ul style="list-style-type: none"> ■ Requires SNMP manager software ■ Least visually appealing of all three methods ■ Some settings require calculations ■ Security can be compromised (hackers only need to know the community name)

Table 3-1 Comparison of Management Methods

3.3 Web Management

The PoE Web Smart Switch offers management features that allow users to manage the PoE Web Smart Switch from anywhere on the network through a standard browser such as Microsoft Internet Explorer. After you set up your IP address for the switch, you can access the PoE Web Smart Switch's Web interface applications directly in your Web browser by entering the IP address of the PoE Web Smart Switch.

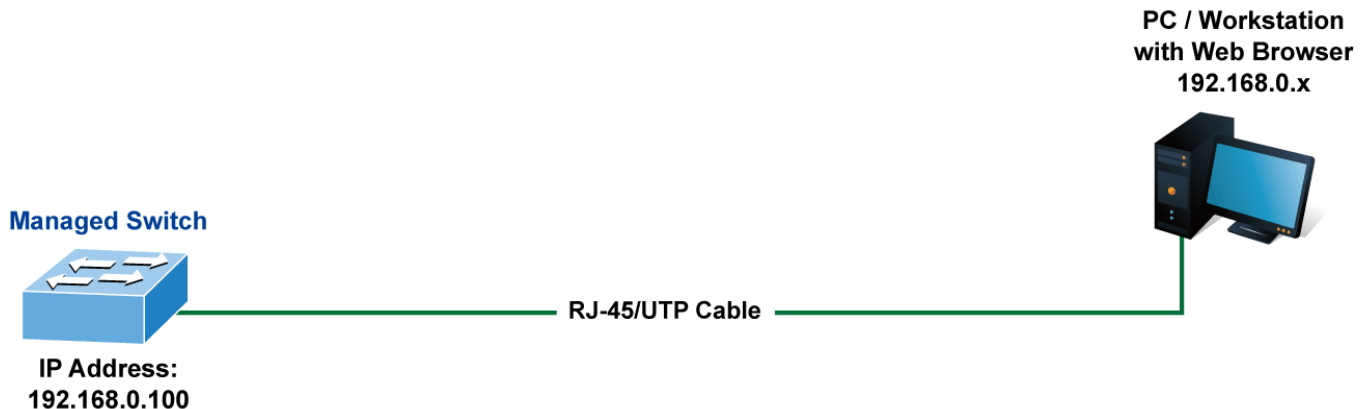

Figure 3-1 Web Management

You can then use your Web browser to list and manage the PoE Web Smart Switch configuration parameters from one central location, just as if you were directly connected to the PoE Web Smart Switch's console port. Web Management requires either **Microsoft Internet Explorer 8.0** or later, **Google Chrome**, **Safari** or **Mozilla Firefox 1.5** or later.



The following web screen based on FGSW-1816HPS will be the same as that of FGSD-1008HPS and FGSW-2624HPS / FGSW-2624HPS4.



Figure 3-2 Web Main Screen of the PoE Web Smart Switch

3.4 SNMP-based Network Management

You can use an external SNMP-based application to configure and manage the PoE Web Smart Switch, such as SNMPc Network Manager, HP Openview Network Node Management (NNM) or What's Up Gold. This management method requires the SNMP agent on the switch and the SNMP Network Management Station to use the **same community string**. This management method, in fact, uses two community strings: the **get community** string and the **set community** string. If the SNMP Network Management Station only knows the set community string, it can read and write to the MIBs. However, if it only knows the get community string, it can only read MIBs. The default gets and set community strings for the PoE Web Smart Switch are public.

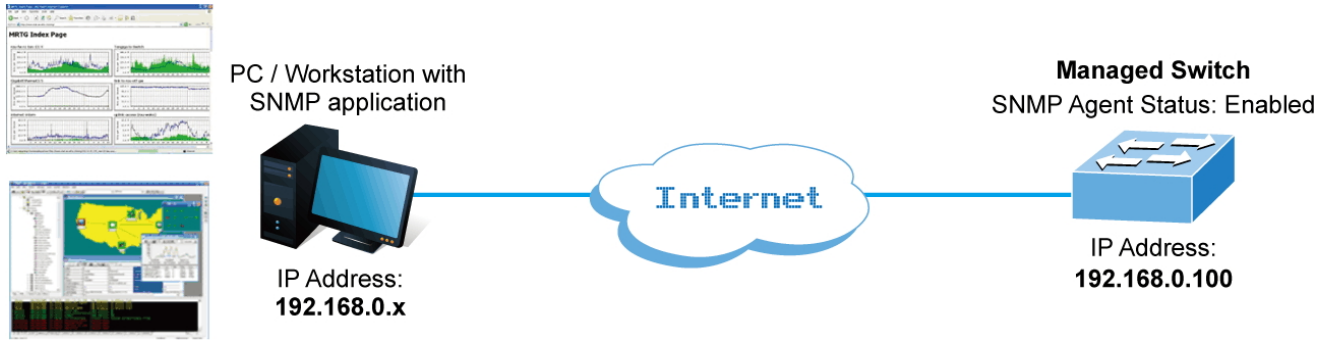

Figure 3-3 SNMP Management

3.5 PLANET Smart Discovery Utility

For easily listing the PoE Web Smart Switch in your Ethernet environment, the Planet Smart Discovery Utility from PLANET web site is an ideal solution. The following installation instructions are to guide you to running the Planet Smart Discovery Utility.

1. Deposit the Planet Smart Discovery Utility in administrator PC.
2. Run this utility as the following screen appears.

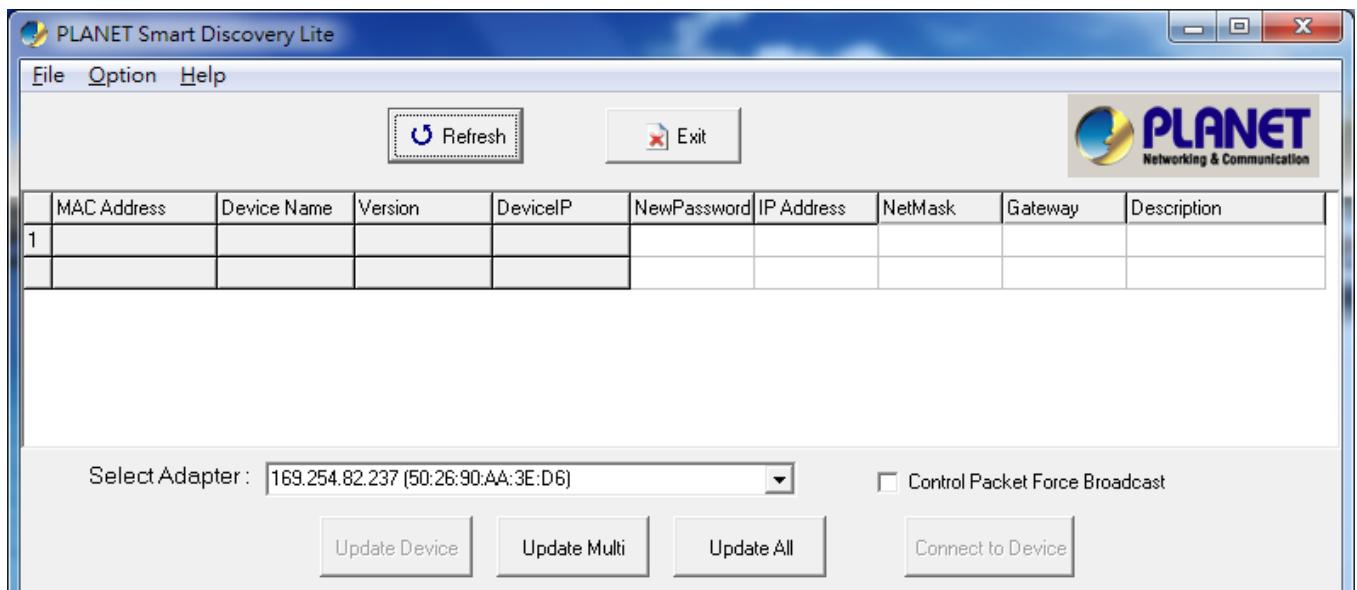

Figure 3-4: Planet Smart Discovery Utility Screen



If there are two LAN cards or above in the same administrator PC, choose a different LAN card by using the “**Select Adapter**” tool.

3. Press the “**Refresh**” button for the currently connected devices in the discovery list as the screen shows below:

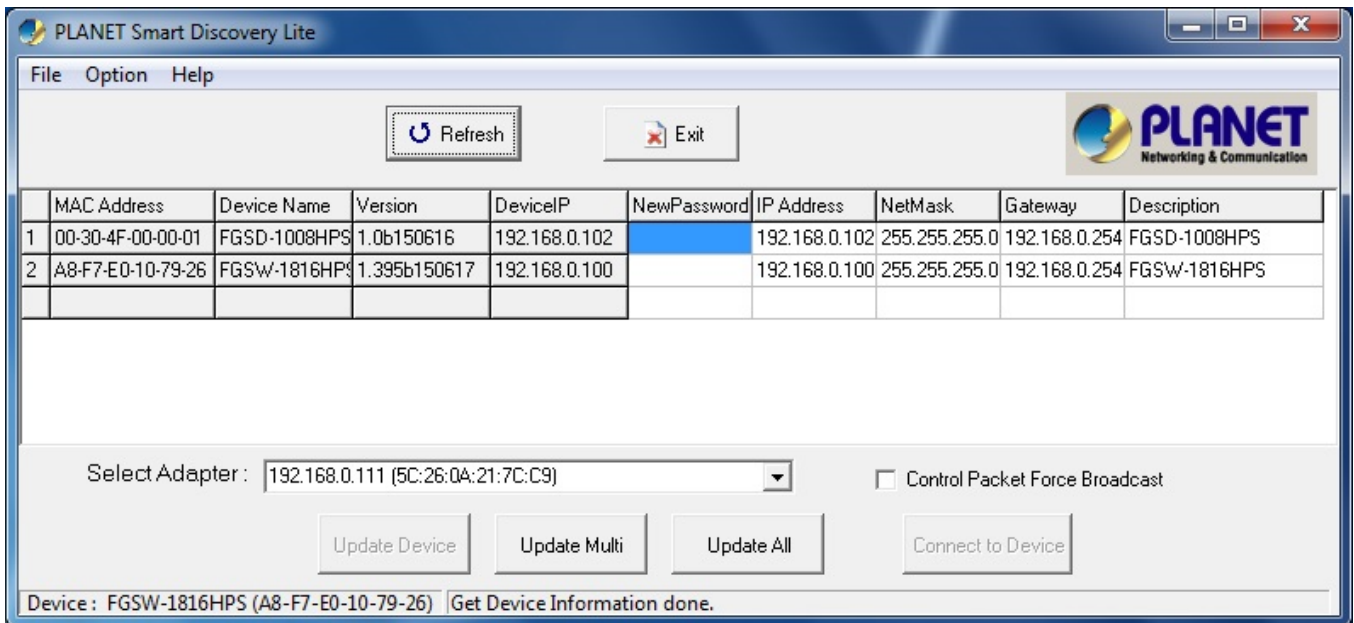

Figure 3-5: Planet Smart Discovery Utility Screen

1. This utility shows all necessary information from the devices, such as MAC Address, Device Name, firmware version and Device IP Subnet address. It can also assign new password, IP subnet address and description to the devices.
2. After setup is completed, press the **“Update Device”**, **“Update Multi”** or **“Update All”** button to take effect. The meaning of the 3 buttons above are shown below:
 - **Update Device:** use the current setting on one single device.
 - **Update Multi:** use the current setting on multi-devices.
 - **Update All:** use the current setting on whole devices in the list.

The same functions mentioned above also can be found in **“Option”** tools bar.
3. To click the **“Control Packet Force Broadcast”** function, it allows you to assign a new setting value to the Web Smart Switch under a different IP subnet address.
4. Press the **“Connect to Device”** button and the Web login screen appears in [Figure 3-2](#).
5. Press the **“Exit”** button to shut down the Planet Smart Discovery Utility.

4. WEB CONFIGURATION

This section introduces the configuration and functions of the Web-based management.

About Web-based Management

The PoE Web Smart Switch offers management features that allow users to manage the PoE Web Smart Switch from anywhere on the network through a standard browser such as Microsoft Internet Explorer.

The Web-based Management supports Internet Explorer 8.0. It is based on Java Applets with an aim to reduce network bandwidth consumption, enhance access speed and present an easy viewing screen.



By default, IE8.0 or later version does not allow Java Applets to open sockets. The user has to explicitly modify the browser setting to enable Java Applets to use network ports.

The PoE Web Smart Switch can be configured through an Ethernet connection, making sure the manager PC must be set on the same IP subnet address as the PoE Web Smart Switch.

For example, the default IP address of the PoE Web Smart Switch is **192.168.0.100**, then the manager PC should be set at **192.168.0.x** (where x is a number between 1 and 254, except 100), and the default subnet mask is 255.255.255.0.

If you have changed the default IP address of the PoE Web Smart Switch to 192.168.1.1 with subnet mask 255.255.255.0 via console, then the manager PC should be set at 192.168.1.x (where x is a number between 2 and 254) to do the relative configuration on manager PC.

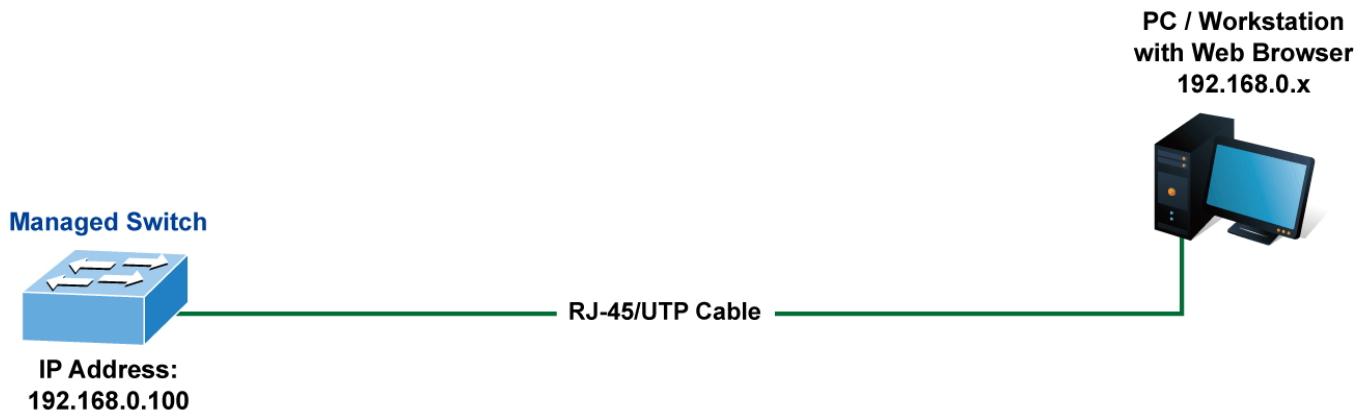

Figure 4-1 Web Management

■ Logging on the switch

1. Use Internet Explorer 8.0 or above Web browser. Enter the factory-default IP address to access the Web interface. The factory default IP address is as follows:

<http://192.168.0.100>

- When the following login screen appears, please enter "admin" as the default username and "admin" as the password (unless you have changed these, in which case use your own login details) to log in the main screen of the PoE Web Smart Switch. The login screen in [Figure 4-2](#) appears.



Figure 4-2 Login Screen

Default User Name: **admin**

Default Password: **admin**



The following web screen based on FGSW-1816HPS will be the same as that of FGSD-1008HPS and FGSW-2624HPS / FGSW-2624HPS4.

After entering the username and password, the main screen appears as [Figure 4-3](#).



Figure 4-3 Default Main Page

Now, you can use the Web management interface to continue the switch management or manage the PoE Web Smart Switch by Web interface. The Switch Menu on the left of the web page let you access all the commands and statistics the PoE Web Smart Switch provides.



For security reason, please change and memorize the new password after this first setup.
Only accept command in lowercase letter under web interface.

4.1 Main Web Page

The PoE Web Smart Switch provides a Web-based browser interface for configuring and managing it. This interface allows you to access the PoE Web Smart Switch using the Web browser of your choice. This chapter describes how to use the PoE Web Smart Switch's Web browser interface to configure and manage it.

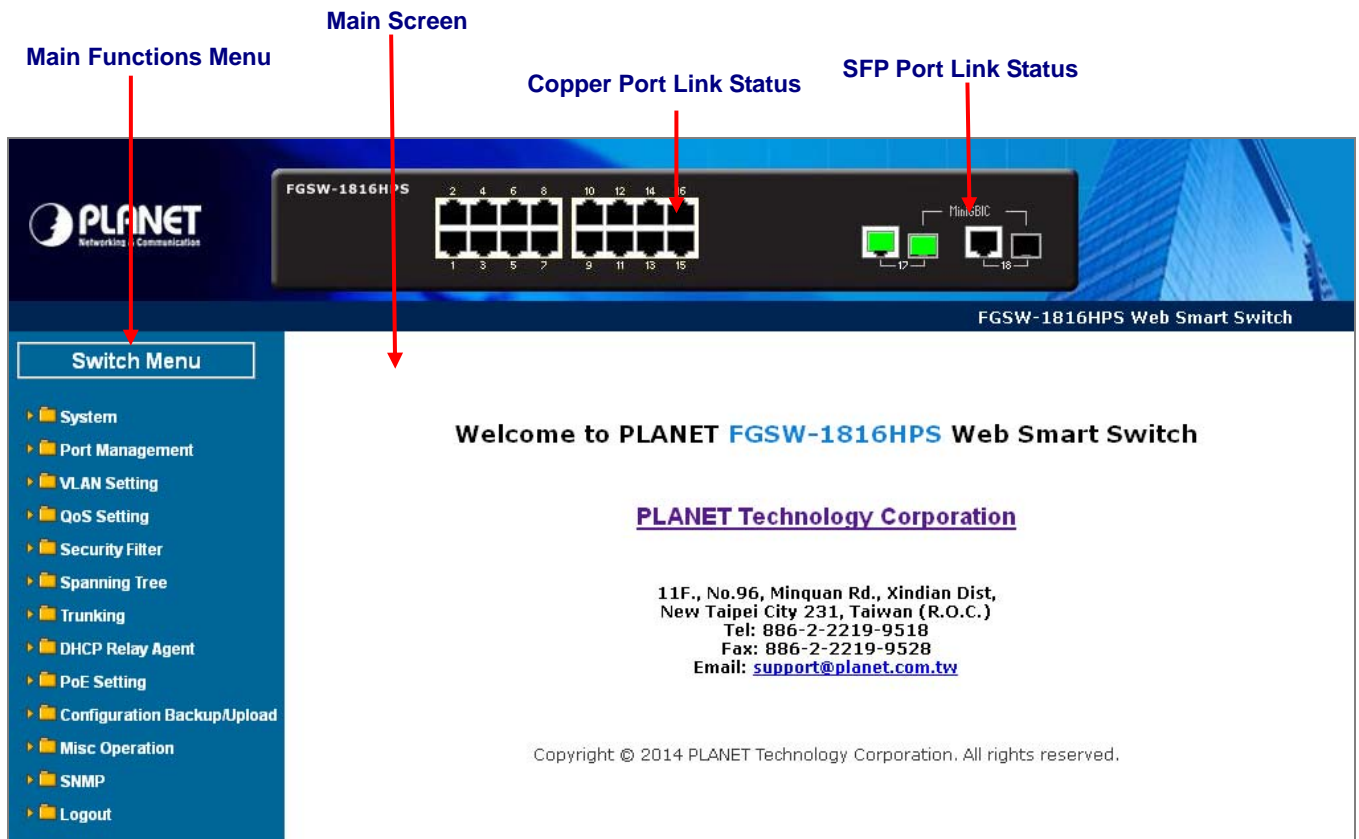





Figure 4-1-1 Main Page

Panel Display

The web agent displays an image of the PoE Web Smart Switch's ports. The Mode can be set to display different information for the ports, including Link up or Link down. Clicking on the image of a port opens the **Port Statistics** page.

The port statuses are illustrated as follows:

Status	Down	Link
RJ45 Ports		
SFP Ports		

Main Menu

Using the onboard web agent, you can define system parameters, manage and control the PoE Web Smart Switch, and all its ports, or monitor network conditions. Via the Web-Management, the administrator can set up the PoE Web Smart Switch by selecting the functions those listed in the Main Function. The screen in [Figure 4-1-2](#) appears.

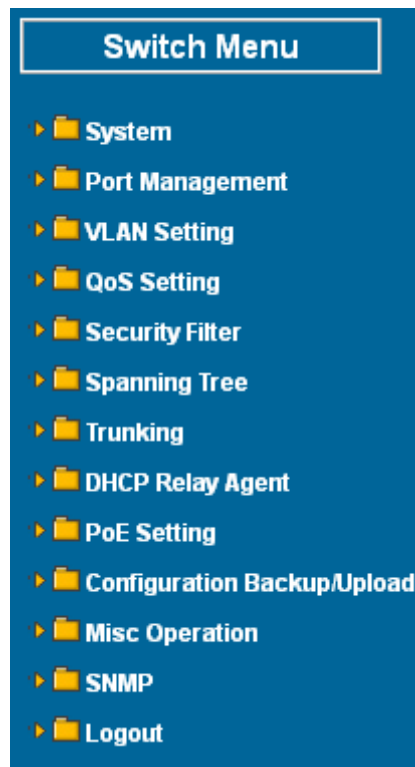

Figure 4-1-2 PoE Web Smart Switch Main Functions Menu

4.2 System

Use the System menu items to display and configure basic administrative details of the PoE Web Smart Switch. Under the System, the following topics are provided to configure and view the system information: This section has the following items:

■ System Information	The switch system information is provided here.
■ IP Configurations	Configure the switch-managed IP information on this page.
■ Password Setting	Configure new user name and password on this page.
■ Factory Default	Restore the default configuration on the switch.
■ Firmware Update	Upgrade the firmware on this page.
■ Reboot	Restart the switch.

4.2.1 System Information

The System Info page provides information for the current device information. System Info page helps a switch administrator to identify the hardware MAC address, software version and system uptime. The screens in [Figure 4-2-1](#) appear.

System Information

Comment	FGSW-1816HPS <input type="text" value="max: 15"/>
System Description	16-Port 10/100TX 802.3at PoE + 2-Port Gigabit TP/SFP Combo Web Smart Ethernet Switch
MAC Address	00:30:4f:00:00:03
Hardware Version	1.0
Software Version	v1.395b140627
<input checked="" type="checkbox"/> Idle Time Security	Idle Time: <input type="text" value="5"/> (1~30 Minutes) <input checked="" type="radio"/> Auto Logout(Default). <input type="radio"/> Back to the last display.
<input type="button" value="Apply"/>	

Figure 4-2-1 System Information Page Screenshot

The page includes the following fields:

Object	Description
• Comment	Describes the PoE Web Smart Switch. Up to 15 characters is allowed for the Device Description.
• System Description	Display the current Switch title.
• MAC Address	The MAC Address of this PoE Web Smart Switch.
• Hardware Version	The version of hardware.

• Software Version	The version of software
• Idle Time Security	Set idle time and behavior.

Button

 : Click to apply changes

4.2.2 IP Configurations

The IP configuration includes the IP Address, Subnet Mask and Gateway. The configured column is used to view or change the IP configuration. Fill out the IP Address, Subnet Mask and Gateway for the device. The screens in [Figure 4-2-2](#) appear.

System IP Configuration

IP Address	<input type="text" value="192"/> . <input type="text" value="168"/> . <input type="text" value="0"/> . <input type="text" value="100"/>
Subnet Mask	<input type="text" value="255"/> . <input type="text" value="255"/> . <input type="text" value="255"/> . <input type="text" value="0"/>
Gateway	<input type="text" value="192"/> . <input type="text" value="168"/> . <input type="text" value="0"/> . <input type="text" value="254"/>
IP Configure	<input checked="" type="radio"/> Static <input type="radio"/> DHCP
<input type="button" value="Apply"/>	

Figure 4-2-2 IP Address Setting Page Screenshot

The page includes the following fields:

Object	Description
• IP Address	Provide the IP address of this switch in dotted decimal notation.
• Subnet Mask	Provide the subnet mask of this switch in dotted decimal notation.
• Gateway	Provide the IP address of the router in dotted decimal notation.
• IP Configure	Indicate the IP address mode operation. Possible modes are: Static : Enable Static IP mode operation. DHCP : Enable DHCP client mode operation.

Button

 : Click to apply changes

4.2.3 Password Setting

This page provides a configuration of the current User name and Password. After the setup is completed, please press “Apply” button to take effect. Please log in web interface with new user name and password and the screens in [Figure 4-2-3](#) appear.





Figure 4-2-3 Password Setting Web Page Screen

The page includes the following fields:

Object	Description
<ul style="list-style-type: none"> • Username 	The name identifying the user. Maximum length: 15 characters; Character range: "a-z","A-Z","0-9","_","+","-","="
<ul style="list-style-type: none"> • Password Confirm 	Enter the user's new password here. Maximum length: 15 characters; Character range: "a-z","A-Z","0-9","_","+","-","="

Button

 : Click to apply changes

4.2.4 Factory Default

This section provides reset the PoE Web Smart Ethernet Switch to factory default mode, the screen in [Figure 4-2-4](#) appears.



Figure 4-2-4 Factory Default Web Page Screen

Button

 : Click to apply changes.

Press the “**Factory Default**” button to take affect. After finishing the operation, the following screen in [Figure 4-2-5](#) appears, and please press the “**Reboot**” button to return back to the Web login screen. After inputting default username and password, continue the PoE Web Smart Ethernet Switch management.

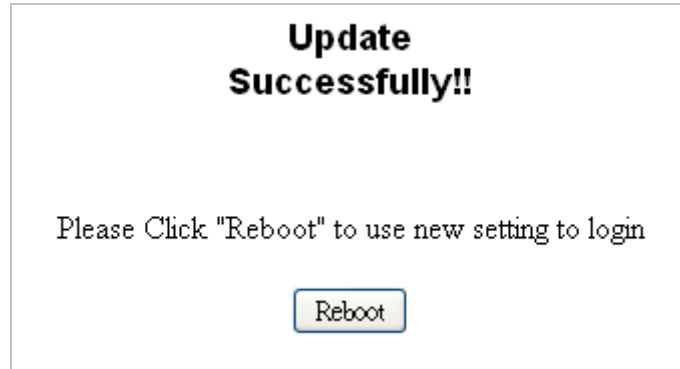

Figure 4-2-5 Web Page Screen of Factory Default Finish

4.2.5 Firmware Update

This section provides firmware upgrade of the PoE Web Smart Ethernet Switch, the screen in [Figure 4-2-6](#) appears. Before Firmware Update, it will ask for the Password to confirm this procedure.

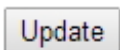

Figure 4-2-6 Firmware Update Web Page Screen

The page includes the following fields:

Object	Description
• Password	Enter the user's password.
• Re-Confirm	Re-enter the user's password.

Button

 : Click to apply changes

Key-in the password and press the “Update” button to take effect. After pressing the “Update” button, the screen in Figure 4-2-7 appears. The warning message is for double confirmation.



Figure 4-2-7 Warning Message Screen

Press the “OK” button for starting the firmware upgrade process and the screen in Figure 4-2-8 appears.

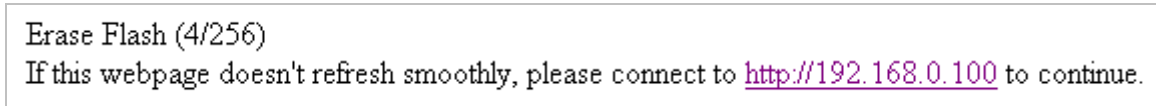

Figure 4-2-8 Firmware Update Web Page Screen

When the following screen appears, press the “Browser” button to find the firmware location administrator PC as the screen in Figure 4-2-9 appears.

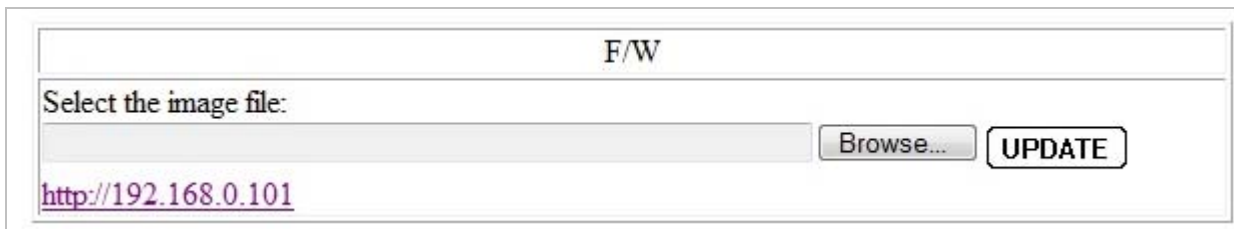

Figure 4-2-9 Firmware Update Web Page Screen

After finding the firmware location from administrator PC, press the “Update” button to start the firmware upgrade process. The screen in Figure 4-2-10 appears.



Figure 4-2-10 Firmware Update Web Page Screen

When firmware upgrade process is completed, the following screen appears. Please press the “continue” button and wait for system reboot. After the device reboot, use the latest firmware of the PoE Web Smart Ethernet Switch.



Figure 4-2-11 Firmware Update Web Page Screen



-
1. Recommend using IE 8.0 or FireFox browser tools for firmware upgrade process.
 2. Firmware upgrade needs several minutes. Please wait awhile, and don't power off the PoE Web Smart Ethernet Switch until the update progress is completed.
-

4.2.6 Reboot

The **Reboot** page enables the device to be rebooted from a remote location. Once the Confirm button is pressed, user has to re-login the Web interface about 60 seconds later. The Reboot Switch screen in [Figure 4-2-12](#) appears and click to reboot the system.



Figure 4-2-12 Reboot Switch Page Screenshot

Press the **“Confirm”** button to reboot the PoE Web Smart Ethernet Switch. After device reboot is completed, the Web login screen appears and login for further management.

4.3 Port Management

Use the Port Menu to display or configure the PoE Web Smart Switch's ports. This section has the following items:

- **Port Configuration** Configure port configuration settings
- **Port Mirroring** Set the source and target ports for mirroring
- **Bandwidth Control** Configure bandwidth limitation
- **Broadcast Storm Control** Configure broadcast storm control settings
- **Port Statistics** List Ethernet port statistics

4.3.1 Port Configuration

This page displays current port configurations and status. Ports can also be configured here. The table has one row for each port on the selected switch in a number of columns, which are:

The Port Configuration screens in [Figure 4-3-1](#) appear.

Port Configuration

Function	Tx/Rx Ability	Auto-Negotiation	Speed	Duplex	Pause	Backpressure	Addr. Learning
	----	----	----	----	----	----	----
Select Port No.	01 <input type="checkbox"/> 02 <input type="checkbox"/> 03 <input type="checkbox"/> 04 <input type="checkbox"/> 05 <input type="checkbox"/> 06 <input type="checkbox"/> 07 <input type="checkbox"/> 08 <input type="checkbox"/> 09 <input type="checkbox"/> 10 <input type="checkbox"/> 11 <input type="checkbox"/> 12 <input type="checkbox"/> 13 <input type="checkbox"/> 14 <input type="checkbox"/> 15 <input type="checkbox"/> 16 <input type="checkbox"/> 17 <input type="checkbox"/> 18 <input type="checkbox"/>						
<input type="button" value="Apply"/>							

Port	Current Status				Setting Status							
	Link	Speed	Duplex	FlowCtrl	Tx/Rx Ability	Auto-Nego	Speed	Duplex	Pause	Backpressure	Addr. Learning	
1	---	---	---	---	ON	AUTO	100M	FULL	ON	ON	ON	
2	---	---	---	---	ON	AUTO	100M	FULL	ON	ON	ON	
3	---	---	---	---	ON	AUTO	100M	FULL	ON	ON	ON	
4	---	---	---	---	ON	AUTO	100M	FULL	ON	ON	ON	
5	---	---	---	---	ON	AUTO	100M	FULL	ON	ON	ON	
6	---	---	---	---	ON	AUTO	100M	FULL	ON	ON	ON	
7	---	---	---	---	ON	AUTO	100M	FULL	ON	ON	ON	
8	---	---	---	---	ON	AUTO	100M	FULL	ON	ON	ON	
9	---	---	---	---	ON	AUTO	100M	FULL	ON	ON	ON	
10	---	---	---	---	ON	AUTO	100M	FULL	ON	ON	ON	
11	---	---	---	---	ON	AUTO	100M	FULL	ON	ON	ON	
12	---	---	---	---	ON	AUTO	100M	FULL	ON	ON	ON	
13	---	---	---	---	ON	AUTO	100M	FULL	ON	ON	ON	
14	---	---	---	---	ON	AUTO	100M	FULL	ON	ON	ON	
15	---	---	---	---	ON	AUTO	100M	FULL	ON	ON	ON	
16	---	---	---	---	ON	AUTO	100M	FULL	ON	ON	ON	
17	●	100M	FULL	ON	ON	AUTO	1G	FULL	ON	ON	ON	
18	---	---	---	---	ON	AUTO	1G	FULL	ON	ON	ON	

Figure 4-3-1 Port Settings Page Screenshot

The page includes the following fields:

Object	Description
<ul style="list-style-type: none"> • Tx/Rx Ability 	<p>Indicates the port state operation. Possible statuses are:</p> <ul style="list-style-type: none"> ■ Enable - Start up the port manually. ■ Disable – Shut down the port manually.
<ul style="list-style-type: none"> • Auto-Negotiation 	<p>Enable and Disable. Being set as Auto, the speed and duplex mode are negotiated automatically. When you set it as Disable, you have to set the speed and duplex mode manually</p> <ul style="list-style-type: none"> ■ Enable – Start up the Auto negotiation. ■ Disable – Shut down the Auto negotiation
<ul style="list-style-type: none"> • Speed 	<p>Select any available link speed for the given switch port. Draw the menu bar to select the mode.</p> <ul style="list-style-type: none"> ■ 10M – Set up 10M Force mode. ■ 100M – Set up 100M Force mode. ■ 1G – Set up 1000M Force mode.
<ul style="list-style-type: none"> • Duplex 	<p>Select any available link duplex for the given switch port. Draw the menu bar to select the mode.</p> <ul style="list-style-type: none"> ■ Full - Force sets Full-Duplex mode. ■ Half - Force sets Half-Duplex mode.
<ul style="list-style-type: none"> • Pause 	<p>When Auto Speed is selected for a port, this section indicates the flow control capability that is advertised to the link partner. When a fixed-speed setting is selected, that is what is used. The current Rx column indicates whether pause frames on the port are obeyed. The current Tx column indicates whether pause frames on the port are transmitted. The Rx and Tx settings are determined by the result of the last Auto-Negotiation. Check the configured column to use flow control.</p> <p>This setting is related to the setting for Configured Link Speed.</p> <ul style="list-style-type: none"> ■ Enable – Start up the flow control. ■ Disable – Shut down the flow control.
<ul style="list-style-type: none"> • Back Pressure 	<p>Select the back pressure mode of the port. Back pressure mode is used with half duplex mode to disable ports from receiving messages. Back pressure mode is enabled by default. The possible field values are:</p> <ul style="list-style-type: none"> ■ Enable – Start up the back pressure mode. ■ Disable – Shut down the back pressure mode.
<ul style="list-style-type: none"> • Address Learning 	<p>Switches remember the source hardware address of each frame received on an interface, and they enter this information into a MAC database called a forward/filter table.</p> <ul style="list-style-type: none"> ■ Enable - Start up the Address Learning. ■ Disable – Shut down Address Learning.
<ul style="list-style-type: none"> • Select Port No. 	<p>Select port number for this check box list.</p>

Button

Apply : Click to apply changes

4.3.2 Port Mirroring

Configure port Mirroring on this page. This function provides the monitoring of network traffic that forwards a copy of each incoming or outgoing packet from one port of a network Switch to another port where the packet can be studied. It enables the manager to keep close track of switch performance and alter it if necessary.

- To debug network problems, selected traffic can be copied, or mirrored, to a mirror port where a frame analyzer can be attached to analyze the frame flow.
- The PoE Web Smart Switch can unobtrusively mirror traffic from any port to a monitor port. You can then attach a protocol analyzer to this port to perform traffic analysis and verify connection integrity.

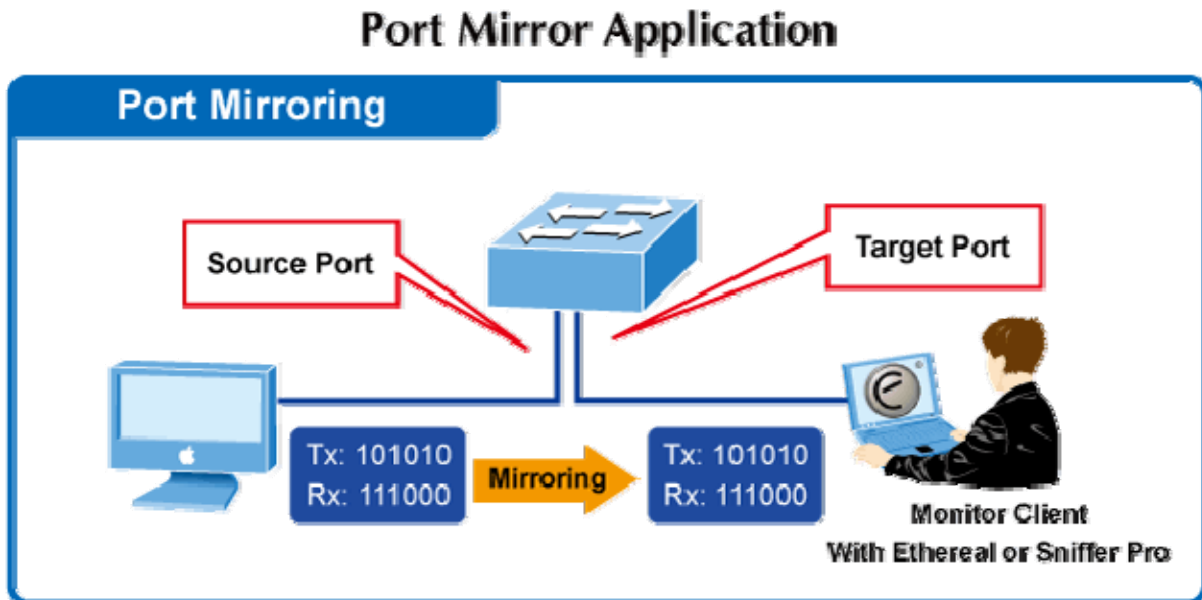

Figure 4-3-2 Port Mirror Application

The traffic to be copied to the mirror port is selected as follows:

1. All frames received on a given port (also known as ingress or source mirroring).
2. All frames transmitted on a given port (also known as egress or destination mirroring).

Mirror Port Configuration

The Port Mirror Configuration screen in [Figure 4-3-3](#) appears.

Port Mirroring

Destination Port Port	1 <input type="checkbox"/>	2 <input type="checkbox"/>	3 <input type="checkbox"/>	4 <input type="checkbox"/>	5 <input type="checkbox"/>	6 <input type="checkbox"/>	7 <input type="checkbox"/>	8 <input type="checkbox"/>	9 <input type="checkbox"/>
	10 <input type="checkbox"/>	11 <input type="checkbox"/>	12 <input type="checkbox"/>	13 <input type="checkbox"/>	14 <input type="checkbox"/>	15 <input type="checkbox"/>	16 <input type="checkbox"/>	17 <input type="checkbox"/>	18 <input type="checkbox"/>
Monitored Packets	Disable <input type="button" value="v"/>								
Source Port	1 <input type="checkbox"/>	2 <input type="checkbox"/>	3 <input type="checkbox"/>	4 <input type="checkbox"/>	5 <input type="checkbox"/>	6 <input type="checkbox"/>	7 <input type="checkbox"/>	8 <input type="checkbox"/>	9 <input type="checkbox"/>
	10 <input type="checkbox"/>	11 <input type="checkbox"/>	12 <input type="checkbox"/>	13 <input type="checkbox"/>	14 <input type="checkbox"/>	15 <input type="checkbox"/>	16 <input type="checkbox"/>	17 <input type="checkbox"/>	18 <input type="checkbox"/>
<input type="button" value="Apply"/>									

Figure 4-3-3 Port Mirroring Settings Page Screenshot

The page includes the following fields:

Object	Description
<ul style="list-style-type: none"> • Destination Port 	Select the port to mirror destination port.
<ul style="list-style-type: none"> • Monitored Packets 	Enable or disable the port mirroring function.
<ul style="list-style-type: none"> • Source Port 	Frames transmitted / received from these ports are mirrored to the mirroring port.

Button

: Click to apply changes

4.3.3 Bandwidth Control

This page provides the selection of the ingress and egress bandwidth preamble. The Bandwidth Control Setting and Status screens in Figures 4-3-4 and 4-3-5 appear.

Bandwidth Control

Port No	Tx Rate	Rx Rate
01	(0~255) <input type="text"/> (0:Full Speed)	(0~255) <input type="text"/> (0:Full Speed)
Speed Base	<div style="text-align: right; margin-bottom: 5px;"> <input type="button" value="Low"/> </div> <p>Low: (1)Tx/Rx bandwidth limitation (Kbps) = Tx/Rx Rate (0~255) x 32Kbps (Port 1~Port 18) Actual Tx/Rx bandwidth =Rate value x 32 kbps. The rate value is 1~255.</p> <p>High: (1)Tx/Rx bandwidth limitation (Kbps) = Tx/Rx Rate (0~255) x 256Kbps (Port 1~Port 16) Actual Tx/Rx bandwidth=Rate value x 256Kbps. The rate value is 1~255. When link speed is 10MB. The rate value is 1~39.</p> <p>(2)Tx/Rx bandwidth limitation (Kbps) = Tx/Rx Rate (0~255) x 2048Kbps (Port 17~Port 18) Actual Tx/Rx bandwidth=Rate value x 2048Kbps. The rate value is 1~255. When link speed is 10MB. The rate value is 1~4. When link speed is 100MB. The rate value is 1~48.</p>	
<input type="button" value="Apply"/> <input type="button" value="LoadDefault"/>		
If the link speed of selected port is lower than the rate that you setting, this system will use the value of link speed as your setting rate.		

Figure 4-3-4 Ingress Bandwidth Control Settings Page Screenshot

The page includes the following fields:

Object	Description
• Port No	Select port number for this drop-down list to enable the function.
• Tx Rate	Configure the Tx rate for the selected port. Valid values are in the range from 0 to 255; 0 is unlimited rate.
• Rx Rate	Configure the Rx rate for the selected port. Valid values are in the range from 0 to 255; 0 is unlimited rate.
• Speed Base	Configure the speed limitation mode. The possible field values are: <div style="margin-left: 20px;"> Low Tx/Rx bandwidth limitation (Kbps) = Tx/Rx Rate (0~255) x 32Kbps (Port 1~Port 18) </div> <div style="margin-left: 20px;"> High Tx/Rx bandwidth limitation (Kbps) = Tx/Rx Rate (0~255) x 256Kbps (10/100Mbps ports) Tx/Rx bandwidth limitation (Kbps) = Tx/Rx Rate (0~255) x 2048Kbps (Gigabit ports). </div>

Buttons

: Click to apply changes

: Click to restore default settings

Port No.	Tx Rate	Rx Rate	Link Speed	Port No.	Tx Rate	Rx Rate	Link Speed
1	Full Speed	Full Speed	---	10	Full Speed	Full Speed	---
2	Full Speed	Full Speed	---	11	Full Speed	Full Speed	---
3	Full Speed	Full Speed	---	12	Full Speed	Full Speed	---
4	Full Speed	Full Speed	---	13	Full Speed	Full Speed	---
5	Full Speed	Full Speed	100M	14	Full Speed	Full Speed	---
6	Full Speed	Full Speed	---	15	Full Speed	Full Speed	---
7	Full Speed	Full Speed	---	16	Full Speed	Full Speed	---
8	Full Speed	Full Speed	---	17	Full Speed	Full Speed	---
9	Full Speed	Full Speed	---	18	Full Speed	Full Speed	---

Figure 4-3-5 Ingress Bandwidth Control Status Page Screenshot

The page includes the following fields:

Object	Description
• Port No	The switch port number of the logical port.
• Tx Rate	Display the current Tx rate limitation.
• Rx Rate	Display the current Rx rate limitation.
• Link Speed	Display the current link speed information.

4.3.4 Broadcast Storm Control

This section introduces detailed settings of Broadcast Storm Control function of PoE Web Smart Ethernet Switch. There is an unknown unicast storm rate control, unknown multicast storm rate control, and a broadcast storm rate control. These only affect flooded frames, i.e. frames with a (VLAN ID, DMAC) pair not present on the MAC Address table. The broadcast storm control is used to block the excessive broadcast packets, the number ranging from 1 to 63. For example, the broadcast storm of the port1~6 are enabled and threshold is set to 10. The broadcast packets will be dropped when broadcast packets are more than threshold setting (packet length is 64 bytes).

The Storm Control Global Setting and Information screen in [Figure 4-3-6](#) appears.

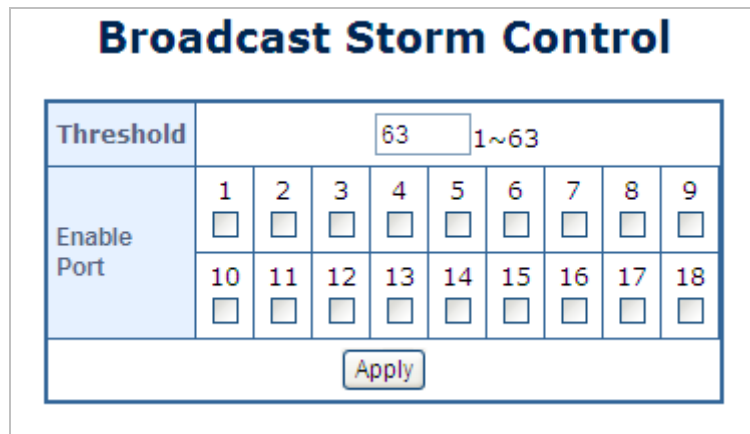

Threshold	63 1~63								
Enable Port	1	2	3	4	5	6	7	8	9
	<input type="checkbox"/>	<input type="checkbox"/>	<input type="checkbox"/>	<input type="checkbox"/>	<input type="checkbox"/>	<input type="checkbox"/>	<input type="checkbox"/>	<input type="checkbox"/>	<input type="checkbox"/>
	10	11	12	13	14	15	16	17	18
	<input type="checkbox"/>	<input type="checkbox"/>	<input type="checkbox"/>	<input type="checkbox"/>	<input type="checkbox"/>	<input type="checkbox"/>	<input type="checkbox"/>	<input type="checkbox"/>	<input type="checkbox"/>
Apply									

Figure 4-3-6 Storm Control Global Setting Page Screenshot

The page includes the following fields:

Object	Description
<ul style="list-style-type: none"> • Threshold 	Configure the Broadcast Threshold for the selected port. Valid values are in the range from 1 to 63; Per unit is 50us for Gigabit speed, 500us for 100Mbps speed and 5000us for 10Mbps speed
<ul style="list-style-type: none"> • Enable Port 	Select port number for this checkbox list to enable the function.

Button

 : Click to apply changes

4.3.5 Port Statistics

This page provides an overview of traffic statistics for all switch ports. The Port Statistics screen in [Figure 4-3-7](#) appears.

Port Statistics		
Counter Mode Selection: Receive Packet & Transmit Packet <input type="button" value="v"/>		
Port	Transmit Packet Receive Packet	
01	0	0
02	0	0
03	0	0
04	0	0
05	4698	2139
06	0	0
07	0	0
08	0	0
09	0	0
10	0	0
11	0	0
12	0	0
13	0	0
14	0	0
15	0	0
16	0	0
17	14061	9835
18	0	0
<input type="button" value="Clear"/> <input type="button" value="Refresh"/>		

Figure 4-3-7 Port Statistics Web Page Screenshot

The page includes the following fields:

Object	Description
<ul style="list-style-type: none"> • Counter Mode Selection 	Select displayed counter mode for this drop-down list. Options: Transmit Packet & Receive Packet The total number of octets transmitted / received out of the interface, including framing characters. Collision Count & Transmit Packet The best estimate of the total number of collisions on this Ethernet segment. Drop packet & Receive Packet

	<p>The total number of events in which packets were dropped due to lack of resources.</p> <p>CRC error packet & Receive Packet</p> <p>The number of CRC/alignment errors (FCS or alignment errors).</p>
--	--

Buttons

: Click to clear statistics.

: Click to refresh the page.

4.4 VLAN

4.4.1 VLAN Overview

A **Virtual Local Area Network (VLAN)** is a network topology configured according to a logical scheme rather than the physical layout. VLAN can be used to combine any collection of LAN segments into an autonomous user group that appears as a single LAN. VLAN also logically segment the network into different broadcast domains so that packets are forwarded only between ports within the VLAN. Typically, a VLAN corresponds to a particular subnet, although not necessarily.

VLAN can enhance performance by conserving bandwidth, and improve security by limiting traffic to specific domains.

A VLAN is a collection of end nodes grouped by logic instead of physical location. End nodes that frequently communicate with each other are assigned to the same VLAN, regardless of where they are physically on the network. Logically, a VLAN can be equated to a broadcast domain, because broadcast packets are forwarded to only members of the VLAN on which the broadcast was initiated.

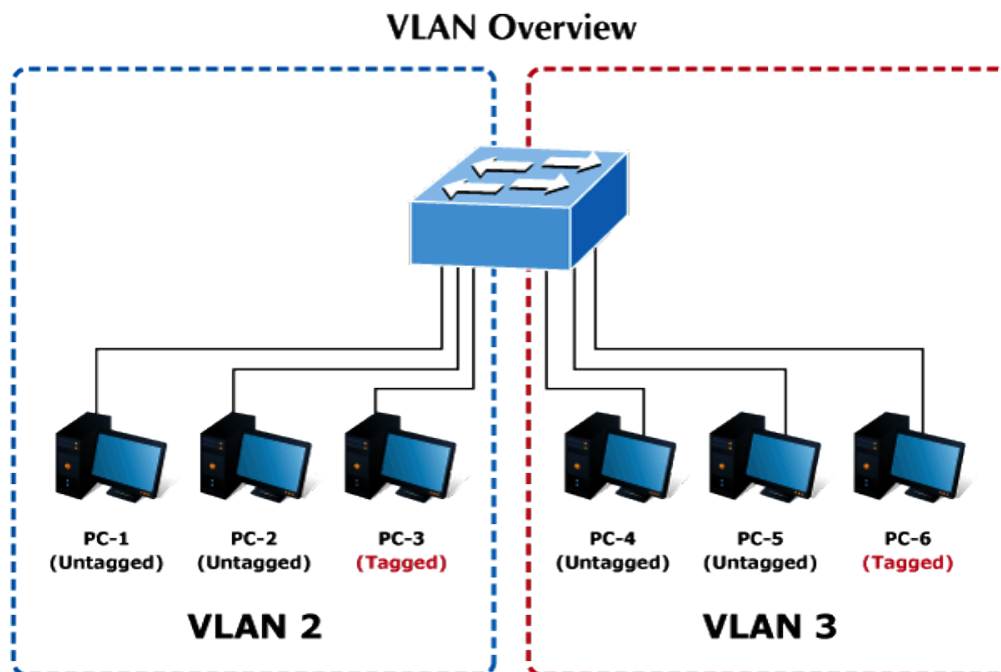

Port-based VLAN

Port-based VLAN limit traffic that flows into and out of switch ports. Thus, all devices connected to a port are members of the VLAN(s) the port belongs to, whether there is a single computer directly connected to a switch, or an entire department.

On port-based VLAN, NICs do not need to be able to identify 802.1Q tags in packet headers. NICs send and receive normal Ethernet packets. If the packet's destination lies on the same segment, communications take place using normal Ethernet protocols. Even though this is always the case, when the destination for a packet lies on another switch port, VLAN considerations come into play to decide if the packet is dropped by the Switch or delivered.

IEEE 802.1Q Tag-based VLAN

IEEE 802.1Q (tagged) VLAN is implemented on the Switch. 802.1Q VLAN requires tagging, which enables them to span the entire network (assuming all switches on the network are IEEE 802.1Q-compliant).

VLAN allow a network to be segmented in order to reduce the size of broadcast domains. All packets entering a VLAN will only be forwarded to the stations (over IEEE 802.1Q enabled switches) that are members of that VLAN, and this includes broadcast, multicast and unicast packets from unknown sources.

VLAN can also provide a level of security to your network. IEEE 802.1Q VLAN will only deliver packets between stations that are members of the VLAN. Any port can be configured as either tagging or untagging. The untagging feature of IEEE 802.1Q VLAN allows VLAN to work with legacy switches that don't recognize VLAN tags in packet headers. The tagging feature allows VLAN to span multiple 802.1Q-compliant switches through a single physical connection and allows Spanning Tree to be enabled on all ports and work normally.

Any port can be configured as either tagging or untagging. The untagging feature of IEEE 802.1Q VLAN allows VLAN to work with legacy switches that don't recognize VLAN tags in packet headers. The tagging feature allows VLAN to span multiple 802.1Q-compliant switches through a single physical connection and allows Spanning Tree to be enabled on all ports and work normally.

Some relevant terms:

Tag - The act of putting 802.1Q VLAN information into the header of a packet.

Untag - The act of stripping 802.1Q VLAN information out of the packet header.



-
1. No matter what basis is used to uniquely identify end nodes and assign these nodes VLAN membership, packets cannot cross VLAN without a network device performing a routing function between the VLAN.
 2. The PoE Web Smart Switch supports IEEE 802.1Q VLAN. The port untagging function can be used to remove the 802.1 tag from packet headers to maintain compatibility with devices that are tag-unaware.
 3. The PoE Web Smart Switch's default is to assign all ports to a single 802.1Q VLAN named DEFAULT_VLAN. As new VLAN is created, the member ports assigned to the new VLAN will be removed from the DEFAULT_VLAN port member list. The DEFAULT_VLAN has a VID = 1.
-

This section has the following items:

- **VLAN Basic Information** Configures the management VLAN.
- **VLAN Port Configuration** Creates the VLAN group.
- **Multi to 1 Setting** Configures mode and PVID on the VLAN port.

4.4.2 VLAN Basic Information

The VLAN Basic Information page displays basic information on the VLAN type supported by the PoE Web Smart Switch. The VLAN Basic Information screen in [Figure 4-4-1](#) appears.

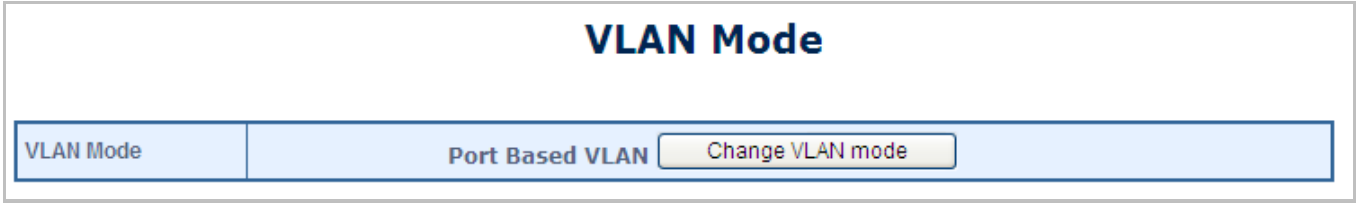

Figure 4-4-1 VLAN Basic Information Page Screenshot

The page includes the following fields:

Object	Description
<ul style="list-style-type: none"> VLAN Mode 	Display the current VLAN mode used by this PoE Web Smart Switch. Options: Port-based IEEE 802.1Q VLAN

4.4.2.1 Port-based VLAN mode

The default VLAN mode is “**Port-based VLAN**” from the VLAN mode. The screen in [Figure 4-4-2](#) appears.

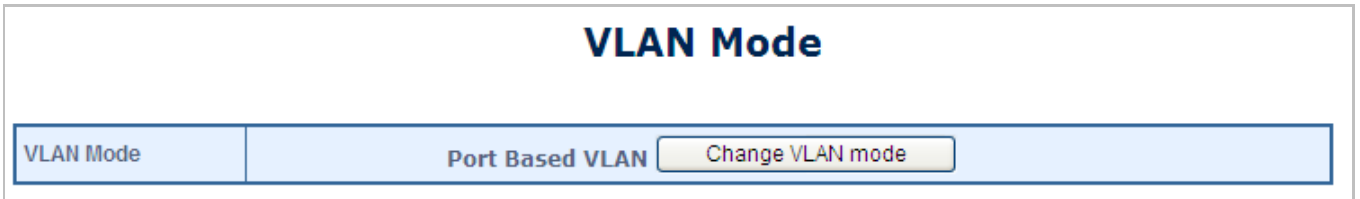

Figure 4-4-2 Port-based VLAN Mode Web Page Screen

4.4.2.2 Tag-based VLAN Mode

This section introduces detailed information of IEEE 802.1Q VLAN function of PoE Web Smart Ethernet Switch. To execute “**Tag-based VLAN**” mode from VLAN mode, press the “**Change VLAN mode**” button to enable the 802.1Q VLAN function. One screen in [Figure 4-4-3](#) will appear, asking for confirming the swap VLAN mode.

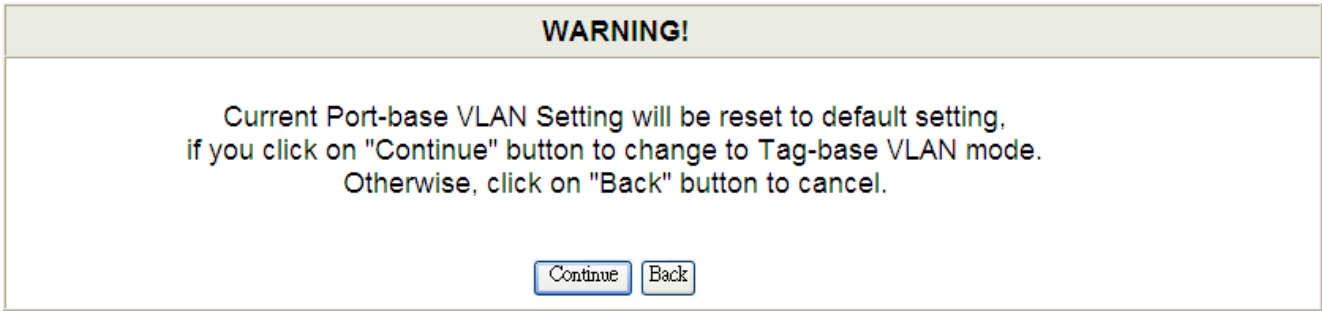

Figure 4-4-3 Change VLAN Mode Warning Web Page Screen

Press the “Continue” button and the current Port-based VLAN mode will swap to the Tag-based VLAN mode. The Screen in Figure 4-4-4 will appear.

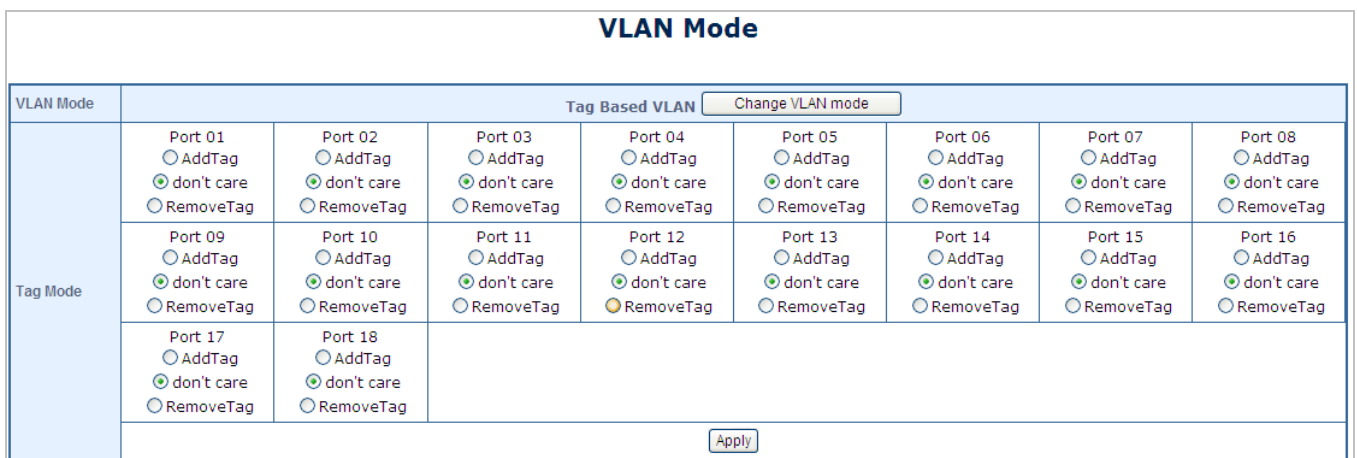



Figure 4-4-4 802.1Q VLAN Configuration Web Page Screen

The page includes the following fields:

Object	Description
<ul style="list-style-type: none"> VLAN Mode 	Display the current VLAN mode used by this PoE Web Smart Switch. Options: <ul style="list-style-type: none"> Tag-based VLAN Port-based VLAN
<ul style="list-style-type: none"> VLAN Tag Mode 	Configure VLAN tag mode. Options: <ul style="list-style-type: none"> Tag / Untag-based on VID Tag / Untag-based on Port
<ul style="list-style-type: none"> Add Tag Type 	Configure VLAN tag type. Options: <ul style="list-style-type: none"> Add Tag Don't Care Remove Tag

Buttons

 : Click to apply changes

 : Click to change VLAN mode.

4.4.3 VLAN Port Configuration

This page introduces detailed information of VLAN Member function of switch. It has two of VLAN Member types, one is for Port-based VLAN mode and one is for Tag-based VLAN mode. Both [Figures 4-4-5 and 4-4-6](#) show the type of VLAN Member.

4.4.3.1 Port-based VLAN Mode

The VLAN Port Configuration screen in [Figure 4-4-5](#) appears.

VLAN Member Setting (Port Based)

Port	02 <input type="button" value="Read"/>								
Dest PORT	01	02	03	04	05	06	07	08	09
Select	<input checked="" type="checkbox"/>	<input checked="" type="checkbox"/>	<input checked="" type="checkbox"/>	<input checked="" type="checkbox"/>	<input checked="" type="checkbox"/>	<input checked="" type="checkbox"/>	<input checked="" type="checkbox"/>	<input checked="" type="checkbox"/>	<input checked="" type="checkbox"/>
Dest PORT	10	11	12	13	14	15	16	17	18
Select	<input checked="" type="checkbox"/>	<input checked="" type="checkbox"/>	<input checked="" type="checkbox"/>	<input checked="" type="checkbox"/>	<input checked="" type="checkbox"/>	<input checked="" type="checkbox"/>	<input checked="" type="checkbox"/>	<input checked="" type="checkbox"/>	<input checked="" type="checkbox"/>
<input type="button" value="Apply"/> <input type="button" value="LoadDefault"/>									

Figure 4-4-5 Port-based VLAN Port Configuration Page Screenshot

The page includes the following fields:

Object	Description
<ul style="list-style-type: none"> Port 	Select port number for this drop-down list to enable the function.
<ul style="list-style-type: none"> Destination Port 	Enable / Disable the selected port to join its VLAN member

Buttons

 : Click to apply changes

 : Click to restore default settings

 : Click to read the information.

4.4.3.2 Tag-based VLAN Mode

The VLAN Port Configuration screen in [Figure 4-4-6](#) appears.

VLAN Member Setting (Tag Based)									
VID: <input type="text" value="1~4094"/> <input type="button" value="Add"/>					selectec <input type="button" value="Delete"/> <input type="button" value="Apply"/>				
Add: Enter a VID, select the VLAN member for this entry and then press this button to add a VLAN entry to the table. Del: Select a VID in the table and then press this button to remove a VID entry from the table. Update: Modify the existing VID entry, select VID and then press the button.									
VLAN Member Port	01	02	03	04	05	06	07	08	
select	<input checked="" type="checkbox"/>	<input checked="" type="checkbox"/>	<input checked="" type="checkbox"/>	<input checked="" type="checkbox"/>	<input checked="" type="checkbox"/>	<input checked="" type="checkbox"/>	<input checked="" type="checkbox"/>	<input checked="" type="checkbox"/>	<input checked="" type="checkbox"/>
VLAN Member Port	09	10	11	12	13	14	15	16	
select	<input checked="" type="checkbox"/>	<input checked="" type="checkbox"/>	<input checked="" type="checkbox"/>	<input checked="" type="checkbox"/>	<input checked="" type="checkbox"/>	<input checked="" type="checkbox"/>	<input checked="" type="checkbox"/>	<input checked="" type="checkbox"/>	<input checked="" type="checkbox"/>
VLAN Member Port	17	18	-	-	-	-	-	-	-
select	<input checked="" type="checkbox"/>	<input checked="" type="checkbox"/>	<input type="checkbox"/>	<input type="checkbox"/>	<input type="checkbox"/>	<input type="checkbox"/>	<input type="checkbox"/>	<input type="checkbox"/>	<input type="checkbox"/>
Note: If you do not select any port, this VID will be treated as a VID embedded in a 802.1Q tag.									
VID Source port	01	02	03	04	05	06	07	08	
select	<input type="checkbox"/>	<input type="checkbox"/>	<input type="checkbox"/>	<input type="checkbox"/>	<input type="checkbox"/>	<input type="checkbox"/>	<input type="checkbox"/>	<input type="checkbox"/>	<input type="checkbox"/>
VID Source port	09	10	11	12	13	14	15	16	
select	<input type="checkbox"/>	<input type="checkbox"/>	<input type="checkbox"/>	<input type="checkbox"/>	<input type="checkbox"/>	<input type="checkbox"/>	<input type="checkbox"/>	<input type="checkbox"/>	<input type="checkbox"/>
VID Source port	17	18	-	-	-	-	-	-	-
select	<input type="checkbox"/>	<input type="checkbox"/>	<input type="checkbox"/>	<input type="checkbox"/>	<input type="checkbox"/>	<input type="checkbox"/>	<input type="checkbox"/>	<input type="checkbox"/>	<input type="checkbox"/>

Figure 4-4-6 Tag-based VLAN Port Configuration Page Screenshot

The page includes the following fields:

Object	Description
<ul style="list-style-type: none"> • VID 	Allow to assign PVID(Port VLAN ID) for selected port. The PVID will be inserted into all untagged frames entering the ingress port. The PVID must be the same as the VLAN ID whose port belongs to VLAN group, or the untagged traffic will be dropped. The range for the PVID is 1-4094 .
<ul style="list-style-type: none"> • VLAN Member Port 	Enable / Disable the selected port to join its VLAN member group
<ul style="list-style-type: none"> • VID Source port 	Enable / Disable the selected port to join its PVID group

Buttons

: Click to apply changes

: Click to add the settings

: Click to delete the settings

4.4.4 Multi to 1 Setting

This setting is exclusive to VLAN setting on “VLAN member setting”. When VLAN member setting is updated, multi-to-1 setting will be void and vice versa. The “disabled port” means the port is excluded in this setting. The function is for Port-based VLAN only. All ports excluded in this setting are treated as the same VLAN group. [Figure 4-4-7](#) shows the Multi to 1 Setting.

The VLAN Port Configuration screen in [Figure 4-4-7](#) appears.

Multi to 1 Setting

Destination PortNo.	01 ▾									
Current Setting	Port:-									
Disable Port	01	02	03	04	05	06	07	08	09	10
	<input type="checkbox"/>	<input type="checkbox"/>	<input type="checkbox"/>	<input type="checkbox"/>	<input type="checkbox"/>	<input type="checkbox"/>	<input type="checkbox"/>	<input type="checkbox"/>	<input type="checkbox"/>	<input type="checkbox"/>
	10	11	12	13	14	15	16	17	18	19
	<input type="checkbox"/>	<input type="checkbox"/>	<input type="checkbox"/>	<input type="checkbox"/>	<input type="checkbox"/>	<input type="checkbox"/>	<input type="checkbox"/>	<input type="checkbox"/>	<input type="checkbox"/>	<input type="checkbox"/>

1.A example for Multi-to-1 structure
 2.The original setting of the VLAN Group will be cleared and replaced by this special structure if you enable this function.
 On the other hand, if you set the VLAN Group again, this special structure will be cleared and replaced by your newest setting.
 3.This configuration is port base VLAN only.

**Destination Port/
Current Setting**

N

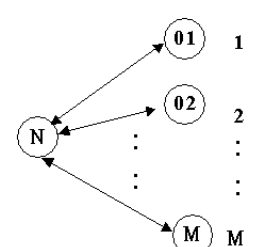

Ports VLAN Groups

01 1

02 2

⋮ ⋮

⋮ ⋮

M M

Figure 4-4-7 Multi to 1 Configuration Page Screenshot

The page includes the following fields:

Object	Description
• Destination Port No.	Configure port mapping destination rule
• Current Setting	Display the current destination port
• Disable Port	Disable multi to 1 setting function for selected port

Button

: Click to apply changes.

4.5 Quality of Service

4.5.1 QoS Overview

Quality of Service (QoS) is an advanced traffic prioritization feature that allows you to establish control over network traffic. QoS enables you to assign various grades of network service to different types of traffic, such as multi-media, video, protocol-specific, time critical, and file-backup traffic.

QoS reduces bandwidth limitations, delay, loss, and jitter. It also provides increased reliability for delivery of your data and allows you to prioritize certain applications across your network. You can define exactly how you want the switch to treat selected applications and types of traffic.

You can use QoS on your system to:

- Control a wide variety of network traffic by:
- Classifying traffic based on packet attributes.
- Assigning priorities to traffic (for example, to set higher priorities to time-critical or business-critical applications).
- Applying security policy through traffic filtering.
- Provide predictable throughput for multimedia applications such as video conferencing or voice over IP by minimizing delay and jitter.
- Improve performance for specific types of traffic and preserve performance as the amount of traffic grows.
- Reduce the need to constantly add bandwidth to the network.
- Manage network congestion.

The **QoS** page of the PoE Web Smart Switch contains three types of QoS mode – the **First-In-First-Out** mode, **All-High-before-Low** mode or **Weighted-Round-Robin** mode can be selected. All the three modes rely on predefined fields within the packet to determine the output queue.

- **First-In-First-Out** Mode –The output queue assignment is determined with first-come, first-served (FCFS) behaviour.
- **All-High-before-Low** Mode - The output queue assignment is determined by the ToS or CoS field in the packets with strict priority.
- **Weighted-Round-Robin** Mode –The output queue assignment is determined by the ToS or CoS field in the packets with scheduling discipline policy.

The PoE Web Smart Switch supports **eight priority level** queues; the queue service rate is based on the **WRR (Weight Round Robin)**. The WRR ratio of high-priority and low-priority can be set to **4:1** or **8:1** or **any**.

4.5.2 Priority Mode

The Priority Mode Setting and Information screen in [Figure 4-5-1](#) appears.

Priority Mode

Priority Mode	
Mode	<input checked="" type="radio"/> First-In-First-Out <input type="radio"/> All-High-before-Low <input type="radio"/> Weight-Round-Robin.
	Low weight: <input type="text" value="0"/> High weight: <input type="text" value="0"/>
<input type="button" value="Apply"/>	
<p>Note: (1) First-In-First-Out is analogous to processing a queue with first-come, first-served (FCFS) behavior (2) All-High-before-Low(Strict Priority) is an element with high priority is served before an element with low priority. (3) Weight-Round-Robin (WRR) is a scheduling discipline. Each packet flow or connection has its own packet queue in a network interface card.</p>	

Figure 4-5-1 Priority Model Setting Page Screenshot

The page includes the following fields:

Object	Description
<ul style="list-style-type: none"> Mode 	Configure QoS mode. The options: <ul style="list-style-type: none"> <input checked="" type="checkbox"/> First-In-First-Out <input checked="" type="checkbox"/> All-High-before-Low <input checked="" type="checkbox"/> Weighted-Round-Robin

4.5.3 Class of Service Configuration

The Class of Service Configuration and Information screen in [Figure 4-5-2](#) appears.

Class of Service Configuration

<input checked="" type="checkbox"/> =Enable High Priority							
Port	Port Base	VLAN Tag	IP / DS	Port	Port Base	VLAN Tag	IP / DS
1	<input type="checkbox"/>	<input type="checkbox"/>	<input type="checkbox"/>	10	<input type="checkbox"/>	<input type="checkbox"/>	<input type="checkbox"/>
2	<input type="checkbox"/>	<input type="checkbox"/>	<input type="checkbox"/>	11	<input type="checkbox"/>	<input type="checkbox"/>	<input type="checkbox"/>
3	<input type="checkbox"/>	<input type="checkbox"/>	<input type="checkbox"/>	12	<input type="checkbox"/>	<input type="checkbox"/>	<input type="checkbox"/>
4	<input type="checkbox"/>	<input type="checkbox"/>	<input type="checkbox"/>	13	<input type="checkbox"/>	<input type="checkbox"/>	<input type="checkbox"/>
5	<input type="checkbox"/>	<input type="checkbox"/>	<input type="checkbox"/>	14	<input type="checkbox"/>	<input type="checkbox"/>	<input type="checkbox"/>
6	<input type="checkbox"/>	<input type="checkbox"/>	<input type="checkbox"/>	15	<input type="checkbox"/>	<input type="checkbox"/>	<input type="checkbox"/>
7	<input type="checkbox"/>	<input type="checkbox"/>	<input type="checkbox"/>	16	<input type="checkbox"/>	<input type="checkbox"/>	<input type="checkbox"/>
8	<input type="checkbox"/>	<input type="checkbox"/>	<input type="checkbox"/>	17	<input type="checkbox"/>	<input type="checkbox"/>	<input type="checkbox"/>
9	<input type="checkbox"/>	<input type="checkbox"/>	<input type="checkbox"/>	18	<input type="checkbox"/>	<input type="checkbox"/>	<input type="checkbox"/>

As long as any of three COS schemes(802.1p,IP TOS/DS or Port Base) is mapped to "high", the data packet will be treated as the high priority.

Figure 4-5-2 Class of Service Configuration Setting Page Screenshot

The page includes the following fields:

Object	Description
<ul style="list-style-type: none">• Mode	Configure Class of Service mode. The options: <ul style="list-style-type: none">■ Port Based - The QoS implementation is based on Physical Port■ VLAN Tag - The QoS implementation is based on VLAN tag■ IP/DS - The QoS implementation is based on DS field of IP header

4.5.4 TCP/UDP Port-based QoS

The TCP/UDP Port-based QoS and Information screen in Figure 4-5-3 appears.

TCP/UDP Port Based QoS

Protocol	Option
FTP(20,21)	F-I-F-O <input type="button" value="v"/>
SSH(22)	F-I-F-O <input type="button" value="v"/>
TELNET(23)	F-I-F-O <input type="button" value="v"/>
SMTP(25)	F-I-F-O <input type="button" value="v"/>
DNS(53)	F-I-F-O <input type="button" value="v"/>
TFTP(69)	Low <input type="button" value="v"/>
HTTP(80,8080)	Low <input type="button" value="v"/>
POP3(110)	F-I-F-O <input type="button" value="v"/>
NEWS(119)	F-I-F-O <input type="button" value="v"/>
SNTP(123)	F-I-F-O <input type="button" value="v"/>
NetBIOS(137~139)	F-I-F-O <input type="button" value="v"/>
IMAP(143,220)	F-I-F-O <input type="button" value="v"/>
SNMP(161,162)	F-I-F-O <input type="button" value="v"/>
HTTPS(443)	F-I-F-O <input type="button" value="v"/>
MSN(1863)	F-I-F-O <input type="button" value="v"/>
XRD_RDP(3389)	F-I-F-O <input type="button" value="v"/>
QQ(62630,62631)	F-I-F-O <input type="button" value="v"/>
ICQ(5190)	F-I-F-O <input type="button" value="v"/>
Yahoo(5050)	F-I-F-O <input type="button" value="v"/>
BOOTP_DHCP(67,68)	Low <input type="button" value="v"/>
User_Define_a	F-I-F-O <input type="button" value="v"/>
User_Define_b	F-I-F-O <input type="button" value="v"/>
User_Define_c	F-I-F-O <input type="button" value="v"/>
User_Define_d	F-I-F-O <input type="button" value="v"/>

User_Define Port number (1~65535)	User_Define_a Port: <input type="text"/> Mask: 0 <input type="text"/>	User_Define_b Port: <input type="text"/> Mask: 0 <input type="text"/>	User_Define_c Port: <input type="text"/> Mask: 0 <input type="text"/>	User_Define_d Port: <input type="text"/> Mask: 0 <input type="text"/>
--	---	---	---	---

Note:
 Example 1, UDP/TCP port = 65535 and Mask = 5, which means 65530, 65531, 65534 and 65535 are all taken into account
 Example 2, UDP/TCP port =65535 and Mask=0, which means only 65535 is taken into account.

TCP/UDP port QoS function

Note:While the "Override" item is selected, the Port_based, Tag_based, IP ToS_based, CoS listed above will be ignored.

The Class of Service for TCP/UDP port number allows the network administrator to assign the specific application to a priority queue.
F-I-F-O: The incoming packet will be forwarded in first-in-first-out scheme.
Discard: The incoming packet will be discarded at the source port.
High: The incoming packet will be forwarded with the high priority.
Low: The incoming packet will be forwarded with the Low priority.

Figure 4-5-3 TCP/UDP Port-based QoS Setting Page Screenshot

The page includes the following fields:

Object	Description
<ul style="list-style-type: none"> • Protocol 	Select IP port number value for the list.
<ul style="list-style-type: none"> • Option 	Select QoS option for this drop-down list. Options: <ul style="list-style-type: none"> ■ F-I-F-O - The output queue assignment is determined with first-come, first-served (FCFS) behaviour ■ Discard - The output queue assignment is determined with discard mode ■ Low - The output queue assignment is determined with low priority mode ■ High - The output queue assignment is determined with high priority mode
<ul style="list-style-type: none"> • TCP/UDP port QoS function 	Configure QoS Override function for this drop-down list Options: <ul style="list-style-type: none"> ■ Override ■ Not Override

Button

 : Click to apply changes.

4.6 Security

This section is to control the access to the PoE Web Smart Switch, including the MAC Address Filter and TCP/UDP Filter.

The Security Page contains links to the following main topics:

- **MAC Address Filter**
- **TCP/UDP Filter**

4.6.1 MAC Address Filter

The MAC Address Filter and Information screen in [Figure 4-6-1](#) appears.

MAC Address Filter Configuration

Port No	MAC Address																		
1	<table style="width: 100%; border-collapse: collapse;"> <tr> <td style="border: 1px solid black; width: 20px; height: 20px;"></td> <td style="border: 1px solid black; width: 20px; height: 20px;"></td> <td style="border: 1px solid black; width: 20px; height: 20px;"></td> <td style="border: 1px solid black; width: 20px; height: 20px;"></td> <td style="border: 1px solid black; width: 20px; height: 20px;"></td> <td style="border: 1px solid black; width: 20px; height: 20px;"></td> </tr> <tr> <td style="border: 1px solid black; width: 20px; height: 20px;"></td> <td style="border: 1px solid black; width: 20px; height: 20px;"></td> <td style="border: 1px solid black; width: 20px; height: 20px;"></td> <td style="border: 1px solid black; width: 20px; height: 20px;"></td> <td style="border: 1px solid black; width: 20px; height: 20px;"></td> <td style="border: 1px solid black; width: 20px; height: 20px;"></td> </tr> <tr> <td style="border: 1px solid black; width: 20px; height: 20px;"></td> <td style="border: 1px solid black; width: 20px; height: 20px;"></td> <td style="border: 1px solid black; width: 20px; height: 20px;"></td> <td style="border: 1px solid black; width: 20px; height: 20px;"></td> <td style="border: 1px solid black; width: 20px; height: 20px;"></td> <td style="border: 1px solid black; width: 20px; height: 20px;"></td> </tr> </table> <p style="text-align: center; margin-top: 5px;"><input type="button" value="Read"/></p>																		
Select Port <input type="text" value="01"/> Binding <input type="text" value="Disable"/> <input type="button" value="Apply"/>																			

Note: If you enable the MAC address binding function, the address leaning function will be disabled automatically.

Port No.	Binding Status	Port No.	Binding Status
1	Disable	10	Disable
2	Disable	11	Disable
3	Disable	12	Disable
4	Disable	13	Disable
5	Disable	14	Disable
6	Disable	15	Disable
7	Disable	16	Disable
8	Disable	17	Disable
9	Disable	18	Disable

Note: The MAC address of current management connection is 00:30:4f:91:e6:45 at port 17.

Figure 4-6-1 MAC Address Filter Setting Page Screenshot

The page includes the following fields:

Object	Description
<ul style="list-style-type: none"> • Select Port 	Select Port from this drop-down list.
<ul style="list-style-type: none"> • Binding 	Configure MAC address binding function from this drop-down list. Options:

	<ul style="list-style-type: none"> ■ Enable ■ Disable
• MAC address	Configure binding MAC address from this table

Buttons

Apply : Click to apply changes

Read : Click to read the information.

4.6.2 TCP/UDP Filter

The TCP/UDP Filter and Information screen in Figure 4-6-2 appears.

TCP/UDP Filter Configuration

Function Enable	<input type="radio"/> Enable <input type="radio"/> Disable														
Port Filtering Rule	<input type="radio"/> Forward <input type="radio"/> Block														
Protocol	<input type="checkbox"/> FTP(20,21)	<input type="checkbox"/> SSH(22)	<input type="checkbox"/> TELNET(23)	<input type="checkbox"/> SMTP(25)	<input type="checkbox"/> DNS(53)	<input type="checkbox"/> TFTP (69)	<input type="checkbox"/> HTTP (80,8080)	<input type="checkbox"/> POP3(110)							
	<input type="checkbox"/> NEWS(119)	<input type="checkbox"/> SNTP(123)	<input checked="" type="checkbox"/> NetBIOS (137~139)	<input type="checkbox"/> IMAP(143,220)	<input type="checkbox"/> SNMP (161,162)	<input type="checkbox"/> HTTPS (443)	<input type="checkbox"/> XRD_RDP (3389)	<input type="checkbox"/> BOOTP_DHCP (67,68)							
Secure WAN port	<input type="checkbox"/> User_Define_a	<input type="checkbox"/> User_Define_b	<input type="checkbox"/> User_Define_c	<input type="checkbox"/> User_Define_d											
	<input type="checkbox"/> Port01	<input type="checkbox"/> Port02	<input type="checkbox"/> Port03	<input type="checkbox"/> Port04	<input type="checkbox"/> Port05	<input type="checkbox"/> Port06	<input type="checkbox"/> Port07	<input type="checkbox"/> Port08							
	<input type="checkbox"/> Port09	<input type="checkbox"/> Port10	<input type="checkbox"/> Port11	<input type="checkbox"/> Port12	<input type="checkbox"/> Port13	<input type="checkbox"/> Port14	<input type="checkbox"/> Port15	<input type="checkbox"/> Port16	<input type="checkbox"/> Port17	<input type="checkbox"/> Port18					

Note:The description of Secure WAN port is shown below.

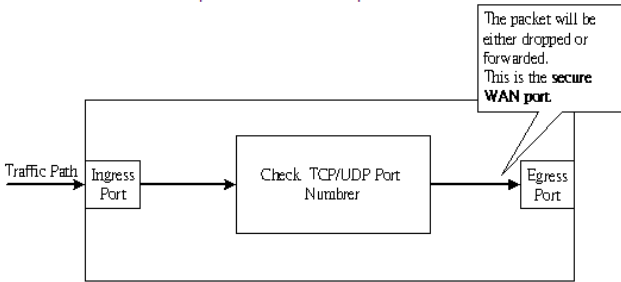

```

graph LR
    TP[Traffic Path] --> IP[Ingress Port]
    IP --> C[Check TCP/UDP Port Numberer]
    C --> EP[Egress Port]
    EP --- Note[The packet will be either dropped or forwarded. This is the secure WAN port.]
            
```

Figure 4-6-2 TCP / UDP Filter Setting Page Screenshot

The page includes the following fields:

Object	Description
• Function Enable	Configure TCP/UDP Filte function for this drop-down list. <div style="border: 1px solid black; padding: 2px; margin-bottom: 2px;">Enable</div> <div style="border: 1px solid black; padding: 2px;">Disable</div>
• Port Filtering Rule	Configure Port Filtering Rule function for this drop-down list. <div style="border: 1px solid black; padding: 2px; margin-bottom: 2px;">Forward- The selected protocol will be forwarded and the other protocols will be dropped.</div> <div style="border: 1px solid black; padding: 2px;">Block- The selected protocol will be dropped and the other protocols will be forwarded.</div>

- **Secure WAN port**

Select Port for this drop-down list.

The egress traffic will be checked whether Port Filter Rule is to drop or to forward packets

Button

 : Click to apply changes

4.7 Spanning Tree

1. Theory

The Spanning Tree Protocol can be used to detect and disable network loops, and to provide backup links between switches, bridges or routers. This allows the switch to interact with other bridging devices in your network to ensure that only one route exists between any two stations on the network, and provide backup links which automatically take over when a primary link goes down. The spanning tree algorithms supported by this switch include these versions:

- **STP – Spanning Tree Protocol (IEEE 802.1D)**
- **RSTP – Rapid Spanning Tree Protocol (IEEE 802.1w)**

The **IEEE 802.1D Spanning Tree** Protocol and **IEEE 802.1w Rapid Spanning Tree** Protocol allow for the blocking of links between switches that form loops within the network. When multiple links between switches are detected, a primary link is established. Duplicated links are blocked from use and become standby links. The protocol allows for the duplicate links to be used in the event of a failure of the primary link. Once the Spanning Tree Protocol is configured and enabled, primary links are established and duplicated links are blocked automatically. The reactivation of the blocked links (at the time of a primary link failure) is also accomplished automatically without operator intervention.

This automatic network reconfiguration provides maximum uptime to network users. However, the concepts of the Spanning Tree Algorithm and protocol are a complicated and complex subject and must be fully researched and understood. It is possible to cause serious degradation of the performance of the network if the Spanning Tree is incorrectly configured. Please read the following before making any changes from the default values.

The Switch STP performs the following functions:

- Creates a single spanning tree from any combination of switching or bridging elements.
- Creates multiple spanning trees – from any combination of ports contained within a single switch, in user specified groups.
- Automatically reconfigures the spanning tree to compensate for the failure, addition, or removal of any element in the tree.
- Reconfigures the spanning tree without operator intervention.

Bridge Protocol Data Units

For STP to arrive at a stable network topology, the following information is used:

- The unique switch identifier
- The path cost to the root associated with each switch port
- The port identifier

STP communicates between switches on the network using Bridge Protocol Data Units (BPDUs). Each BPDU contains the following information:

- The unique identifier of the switch that the transmitting switch currently believes is the root switch
- The path cost to the root from the transmitting port
- The port identifier of the transmitting port

The switch sends BPDUs to communicate and construct the spanning-tree topology. All switches connected to the LAN on which the packet is transmitted will receive the BPDU. BPDUs are not directly forwarded by the switch, but the receiving switch uses the information in the frame to calculate a BPDU, and, if the topology changes, initiates a BPDU transmission.

The communication between switches via BPDUs results in the following:

- One switch is elected as the root switch
- The shortest distance to the root switch is calculated for each switch
- A designated switch is selected. This is the switch closest to the root switch through which packets will be forwarded to the root.
- A port for each switch is selected. This is the port providing the best path from the switch to the root switch.
- Ports included in the STP are selected.

Creating a Stable STP Topology

It is to make the root port a fastest link. If all switches have STP enabled with default settings, the switch with the lowest MAC address in the network will become the root switch. By increasing the priority (lowering the priority number) of the best switch, STP can be forced to select the best switch as the root switch.

When STP is enabled using the default parameters, the path between source and destination stations in a switched network might not be ideal. For instance, connecting higher-speed links to a port that has a higher number than the current root port can cause a root-port change.

STP Port Statuses

The BPDUs take some time to pass through a network. This propagation delay can result in topology changes where a port that transitioned directly from a Blocking state to a Forwarding state could create temporary data loops. Ports must wait for new network topology information to propagate throughout the network before starting to forward packets. They must also wait for the packet lifetime to expire for BPDU packets that were forwarded based on the old topology. The forward delay timer is used to allow the network topology to stabilize after a topology change. In addition, STP specifies a series of states a port must transition through to further ensure that a stable network topology is created after a topology change.

Each port on a switch using STP exists in one of the following five statuses:

- **Blocking** – the port is blocked from forwarding or receiving packets
- **Listening** – the port is waiting to receive BPDU packets that may tell the port to go back to the blocking state
- **Learning** – the port is adding addresses to its forwarding database, but not yet forwarding packets
- **Forwarding** – the port is forwarding packets
- **Disabled** – the port only responds to network management messages and must return to the blocking state first

A port transitions from one status to another as follows:

- From initialization (switch boot) to blocking
- From blocking to listening or to disabled
- From listening to learning or to disabled
- From learning to forwarding or to disabled
- From forwarding to disabled
- From disabled to blocking

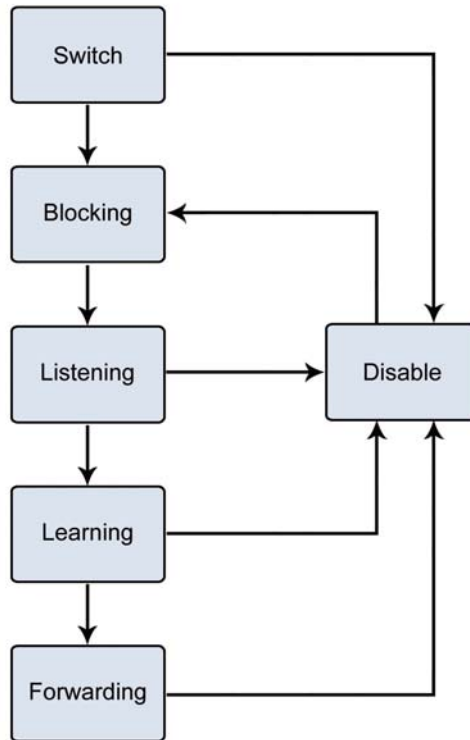



Figure 4-7-1 STP Port Status Transitions

You can modify each port status by using management software. When you enable STP, every port on every switch in the network goes through the blocking status and then transitions through the statuses of listening and learning at power up. If properly configured, each port stabilizes to the forwarding or blocking status. No packets (except BPDUs) are forwarded from, or received by, STP enabled ports until the forwarding status is enabled for that port.

2. STP Parameters

STP Operation Levels

The Switch allows for two levels of operation: the switch level and the port level. The switch level forms a spanning tree consisting of links between one or more switches. The port level constructs a spanning tree consisting of groups of one or more ports. The STP operates in much the same way for both levels.

 Note	On the switch level, STP calculates the Bridge Identifier for each switch and then sets the Root Bridge and the Designated Bridges.
	On the port level, STP sets the Root Port and the Designated Ports.

The following are the user-configurable STP parameters for the switch level:

Parameter	Description	Default Value
Bridge Identifier(Not user configurable)	A combination of the User-set priority and the switch's MAC address.	32768 + MAC

except by setting priority below)	The Bridge Identifier consists of two parts: a 16-bit priority and a 48-bit Ethernet MAC address 32768 + MAC	
Priority	A relative priority for each switch – lower numbers give a higher priority and a greater chance of a given switch being elected as the root bridge	32768
Hello Time	The length of time between broadcasts of the hello message by the switch	2 seconds
Maximum Age Timer	Measures the age of a received BPDU for a port and ensures that the BPDU is discarded when its age exceeds the value of the maximum age timer.	20 seconds
Forward Delay Timer	The amount time spent by a port in the learning and listening states waiting for a BPDU that may return the port to the blocking status.	15 seconds

The following are the user-configurable STP parameters for the port or port group level:

Variable	Description	Default Value
Port Priority	A relative priority for each port –lower numbers give a higher priority and a greater chance of a given port being elected as the root port	128
Port Cost	A value used by STP to evaluate paths – STP calculates path costs and selects the path with the minimum cost as the active path	200,000-100Mbps Fast Ethernet ports 20,000-1000Mbps Gigabit Ethernet ports 0 - Auto

Default Spanning-Tree Configuration

Feature	Default Value
Enable state	STP disabled for all ports
Port priority	128
Port cost	0
Bridge priority	32,768

User-changeable STA Parameters

The Switch's factory default setting should cover the majority of installations. However, it is advisable to keep the default settings as set at the factory; unless, it is absolutely necessary. The user changeable parameters in the Switch are as follows:

Priority – A Priority for the switch can be set from 0 to 65535. 0 is equal to the highest Priority.

Hello Time – The Hello Time can be from 1 to 10 seconds. This is the interval between two transmissions of BPDU packets sent by the Root Bridge to tell all other Switches that it is indeed the Root Bridge. If you set a Hello Time for your Switch, and it is not the Root Bridge, the set Hello Time will be used if and when your Switch becomes the Root Bridge.

 Note	The Hello Time cannot be longer than the Max. Age. Otherwise, a configuration error will occur.
---	---

Max. Age – The Max Age can be from 6 to 40 seconds. At the end of the Max Age, if a BPDU has still not been received from the Root Bridge, your Switch will start sending its own BPDU to all other Switches for permission to become the Root Bridge. If it turns out that your Switch has the lowest Bridge Identifier, it will become the Root Bridge.

Forward Delay Timer – The Forward Delay can be from 4 to 30 seconds. This is the time any port on the Switch spends in the listening status while moving from the blocking status to the forwarding status.

 Note	Observe the following formulas when setting the above parameters: Max. Age _ 2 x (Forward Delay - 1 second) Max. Age _ 2 x (Hello Time + 1 second)
--	--

Port Priority – A Port Priority can be from 0 to 240. The lower the number, the greater the probability the port will be chosen as the Root Port.

Port Cost – A Port Cost can be set from 0 to 200000000. The lower the number, the greater the probability the port will be chosen to forward packets.

3. Illustration of STP

A simple illustration of three switches connected in a loop is depicted in the below diagram. In this example, you can anticipate some major network problems if the STP assistance is not applied.

If switch A broadcasts a packet to switch B, switch B will broadcast it to switch C, and switch C will broadcast it to back to switch A and so on. The broadcast packet will be passed indefinitely in a loop, potentially causing a network failure. In this example, STP breaks the loop by blocking the connection between switch B and C. The decision to block a particular connection is based on the STP calculation of the most current Bridge and Port settings.

Now, if switch A broadcasts a packet to switch C, then switch C will drop the packet at port 2 and the broadcast will end there. Setting-up STP using values other than the defaults, can be complex. Therefore, you are advised to keep the default factory settings and STP will automatically assign root bridges/ports and block loop connections. Influencing STP to choose a particular switch as the root bridge using the Priority setting, or influencing STP to choose a particular port to block using the Port Priority and Port Cost settings is, however, relatively straight forward.

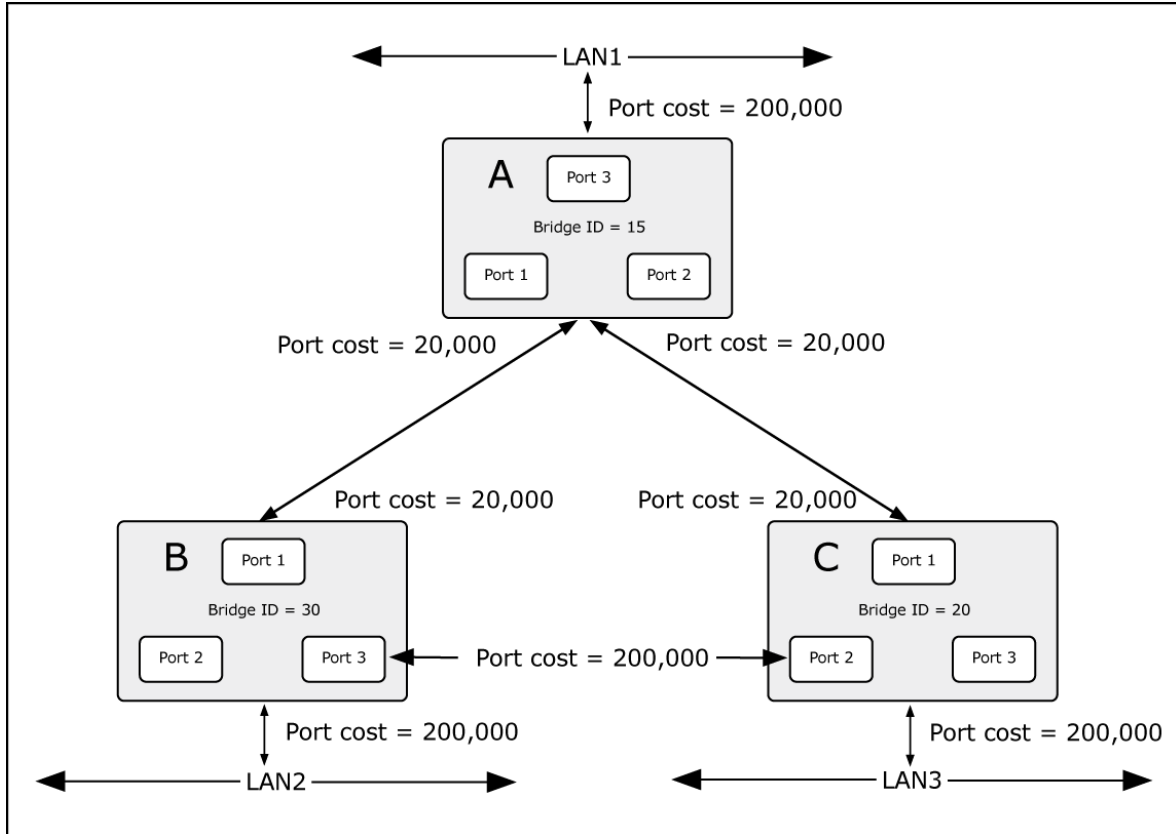

Figure 4-7-2 Before Applying the STA Rules

In this example, only the default STP values are used.

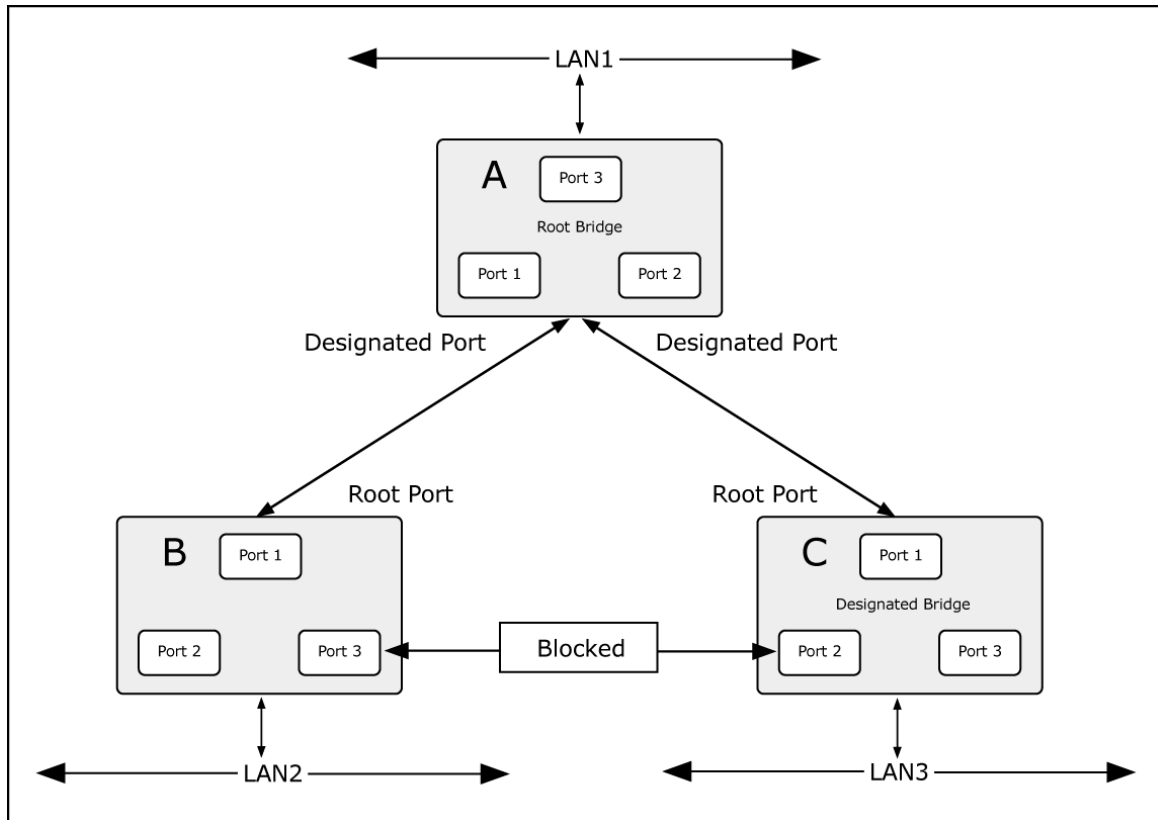

Figure 4-7-3 After Applying the STA Rules

The switch with the lowest Bridge ID (switch C) was elected the root bridge, and the ports were selected to give a high port cost between switches B and C. The two (optional) Gigabit ports (default port cost = 20,000) on switch A are connected to one (optional) Gigabit port on both switch B and C. The redundant link between switch B and C is deliberately chosen as a 100 Mbps Fast Ethernet link (default port cost = 200,000). Gigabit ports could be used, but the port cost should be increased from the default to ensure that the link between switch B and switch C is the blocked link.

This section has the following items:

- **STP Bridge Settings** Configures STP Bridge settings
- **STP Port Settings** Configure STP port setting
- **Loopback Detection** Configuration Loopback Detection settings

4.7.1 STP Bridge Settings

The STP System Configuration screen in [Figure 4-7-4](#) appears.

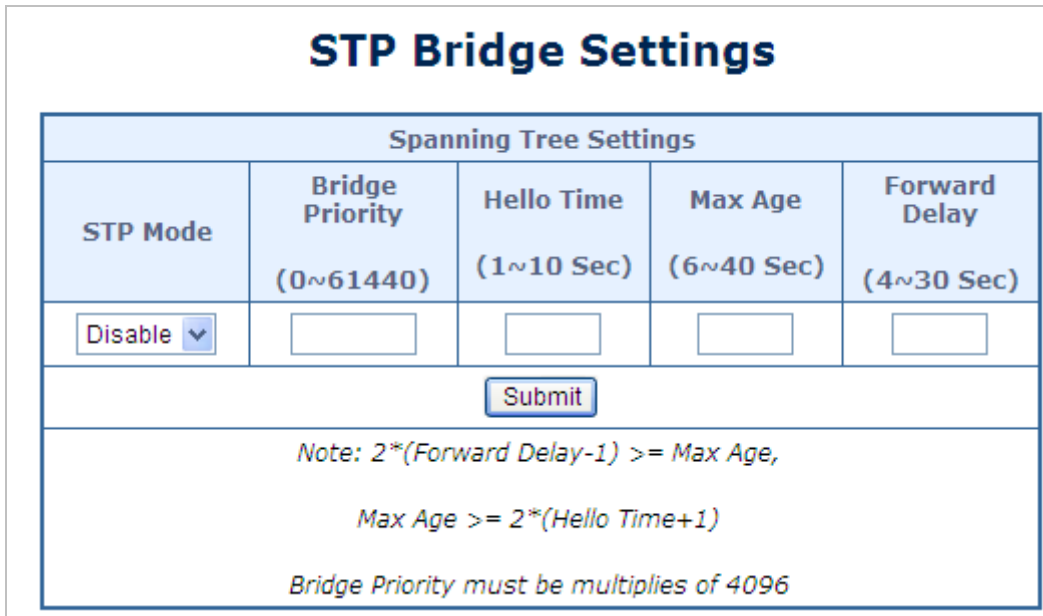

Spanning Tree Settings				
STP Mode	Bridge Priority (0~61440)	Hello Time (1~10 Sec)	Max Age (6~40 Sec)	Forward Delay (4~30 Sec)
Disable ▾	<input type="text"/>	<input type="text"/>	<input type="text"/>	<input type="text"/>
<input type="button" value="Submit"/>				
<p><i>Note: 2*(Forward Delay-1) >= Max Age,</i></p> <p><i>Max Age >= 2*(Hello Time+1)</i></p> <p><i>Bridge Priority must be multiplies of 4096</i></p>				

Figure 4-7-4 STP Bridge Setting page screenshot

The page includes the following fields:

Object	Description
<ul style="list-style-type: none"> • STP Mode 	Select STP mode for this drop-down list. -Disable -STP -RSTP
<ul style="list-style-type: none"> • Bridge Priority (0~61440) 	Controls the bridge priority. Lower numeric values have better priority. The bridge priority plus the MSTI instance number, concatenated with the 6-byte MAC address of the switch forms a Bridge Identifier.

<ul style="list-style-type: none"> • Hello Time (1~10 Sec) 	<p>The time that controls the switch to send out the BPDU packet to check STP current status. Valid values are in the range 6 to 40 seconds.</p> <p>-Default: 2</p> <p>-Minimum: The higher of 1</p> <p>-Maximum: The lower of 10</p>
<ul style="list-style-type: none"> • Max Age (6~40 Sec) 	<p>The maximum age of the information transmitted by the Bridge when it is the Root Bridge. Valid values are in the range 6 to 40 seconds.</p> <p>-Default: 20</p> <p>-Minimum: The higher of 6 or [2 x (Hello Time + 1)].</p> <p>-Maximum: The lower of 40 or [2 x (Forward Delay -1)]</p>
<ul style="list-style-type: none"> • Forward Delay (4~30 Sec) 	<p>The delay used by STP Bridges to transition Root and Designated Ports to Forwarding (used in STP compatible mode). Valid values are in the range 4 to 30 seconds</p> <p>-Default: 15</p> <p>-Minimum: The higher of 4 or [(Max. Message Age / 2) + 1]</p> <p>-Maximum: 30</p>

The Bridge Status screen in [Figure 4-7-5](#) appears.

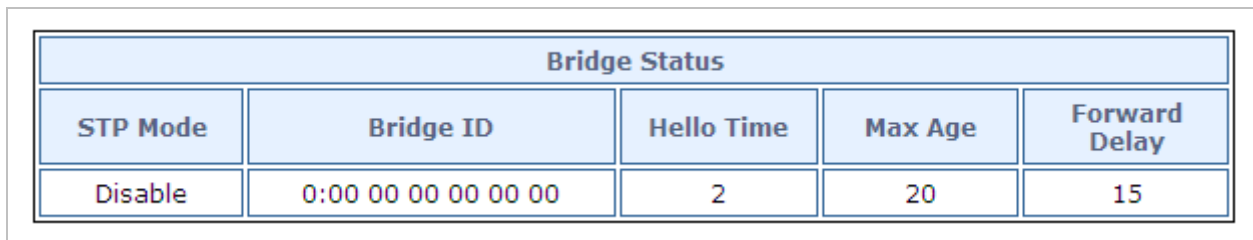

Bridge Status				
STP Mode	Bridge ID	Hello Time	Max Age	Forward Delay
Disable	0:00 00 00 00 00 00	2	20	15

Figure 4-7-5 Bridge Status Page Screenshot

The page includes the following fields:

Object	Description
• STP Mode	Display the STP Mode status
• Bridge ID	Display the Bridge ID
• Hello Time	Display the Hello Time
• Max Age	Display the Max Age
• Forward Delay	Display the Forward Delay

The Root Status screen in [Figure 4-7-6](#) appears.

Root Status			
Root ID	Hello Time	Max Age	Forward Delay
--	--	--	--

Figure 4-7-6 QoS Global Setting Page Screenshot

The page includes the following fields:

Object	Description
• Root ID	Display the Root ID
• Hello Time	Display the Hello Time
• Max Age	Display the Max Age
• Forward Delay	Display the Forward Delay

Button

: Click to apply changes

4.7.2 STP Port Settings

The CIST Ports Configuration screens in [Figure 4-7-7](#) appears.

STP Port Settings

STP Port Settings		
Port No.	Priority (0~240)	Root Path Cost (1~200000000) 0=AUTO
<input type="text" value=""/>	<input type="text" value=""/>	<input type="text" value=""/>
<input type="button" value="Submit"/>		
Priority should be a multiple of 16		

Figure 4-7-7 STP Port Setting Page Screenshot

The page includes the following fields:

Object	Description
• Port No.	Select Port for this drop down list.
• Priority (0~240)	Controls the port priority. This can be used to control priority of ports having identical port cost. (See above). -Default: 128

	-Range: 0-240, in steps of 16
<ul style="list-style-type: none"> • Path Cost (1~200000000) 	Controls the path cost incurred by the port. The Auto setting will set the path cost as appropriate by the physical link speed, using the 802.1D recommended values. Using the Specific setting, a user-defined value can be entered. The path cost is used when establishing the active topology of the network. Lower path cost ports are chosen as forwarding ports in favor of higher path cost ports. Valid values are in the range 1 ~ 200000000.

The STP Port Status screen in [Figure 4-7-8](#) appears.

STP Port Status						
Port No.	RPC	Priority	State	Status	Designated Bridge	Designated Port
1	Auto:0	0x80	--	Disable	--	--
2	Auto:0	0x80	--	Disable	--	--
3	Auto:0	0x80	--	Disable	--	--
4	Auto:0	0x80	--	Disable	--	--
5	Auto:0	0x80	--	Disable	--	--
6	Auto:0	0x80	--	Disable	--	--
7	Auto:0	0x80	--	Disable	--	--
8	Auto:0	0x80	--	Disable	--	--
9	Auto:0	0x80	--	Disable	--	--
10	Auto:0	0x80	--	Disable	--	--
11	Auto:0	0x80	--	Disable	--	--
12	Auto:0	0x80	--	Disable	--	--
13	Auto:0	0x80	--	Disable	--	--
14	Auto:0	0x80	--	Disable	--	--
15	Auto:0	0x80	--	Disable	--	--
16	Auto:0	0x80	--	Disable	--	--
17	Auto:0	0x80	--	Disable	--	--
18	Auto:0	0x80	--	Disable	--	--

Figure 4-7-8 STP Port Status Page Screenshot

The page includes the following fields:

Object	Description
• Path Cost	Display the STP Mode Status
• Priority	Display the Port Priority
• Status	Display the Port Status
• Status	Display the Port Status

Button

: Click to apply changes

4.8 Trunking Setting

Port Aggregation optimizes port usage by linking a group of ports together to form a single Link Aggregated Groups (LAGs). Port Aggregation multiplies the bandwidth between the devices, increases port flexibility, and provides link redundancy.

Each LAG is composed of ports of the same speed, set to full-duplex operations. Ports in a LAG, can be of different media types (UTP/Fiber, or different fiber types), provided they operate at the same speed.

Aggregated Links can be assigned manually (**Port Trunk**) or automatically by enabling Link Aggregation Control Protocol (**LACP**) on the relevant links.

Aggregated Links are treated by the system as a single logical port. Specifically, the Aggregated Link has similar port attributes to a non-aggregated port, including auto-negotiation, speed, Duplex setting, etc.

The device supports the following Aggregation links :

- **Static LAGs (Port Trunk)** – Force aggregated selected ports to be a trunk group.
- **Link Aggregation Control Protocol (LACP)** LAGs - LACP LAG negotiate Aggregated Port links with other LACP ports located on a different device. If the other device ports are also LACP ports, the devices establish a LAG between them.

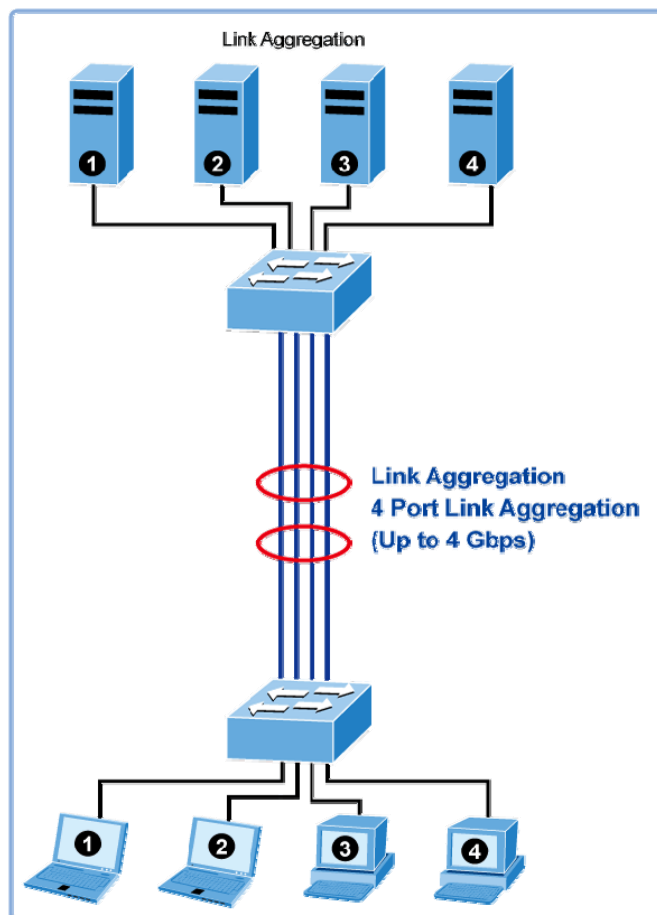

Figure 4-8-1 Link Aggregation

The **Link Aggregation Control Protocol (LACP)** provides a standardized means for exchanging information between Partner Systems that require high speed redundant links. Link aggregation lets you group up to eight consecutive ports into a single dedicated connection. This feature can expand bandwidth to a device on the network. LACP operation requires full-duplex mode, more detail information refer to the IEEE 802.3ad standard.

Port link aggregations can be used to increase the bandwidth of a network connection or to ensure fault recovery. Link aggregation lets you group up to 8 consecutive ports into a single dedicated connection between any two the Switch or other Layer 2 switches. However, before making any physical connections between devices, use the Link aggregation Configuration menu to specify the link aggregation on the devices at both ends. When using a port link aggregation, note that:

- The ports used in a link aggregation must all be of the same media type (RJ45, 100 Mbps fiber).
- The ports that can be assigned to the same link aggregation have certain other restrictions (see below).
- Ports can only be assigned to one link aggregation.
- The ports at both ends of a connection must be configured as link aggregation ports.
- None of the ports in a link aggregation can be configured as a mirror source port or a mirror target port.
- All of the ports in a link aggregation have to be treated as a whole when moved from/to, added or deleted from a VLAN.
- The Spanning Tree Protocol will treat all the ports in a link aggregation as a whole.
- Enable the link aggregation prior to connecting any cable between the switches to avoid creating a data loop.
- Disconnect all link aggregation port cables or disable the link aggregation ports before removing a port link aggregation to avoid creating a data loop.

It allows a maximum of 8 ports to be aggregated at the same time. The PoE Web Smart Switch support Gigabit Ethernet ports (up to 8 groups). If the group is defined as a LACP static link aggregating group, then any extra ports selected are placed in a standby mode for redundancy if one of the other ports fails. If the group is defined as a local static link aggregating group, then the number of ports must be the same as the group member ports.

Use the Link Aggregation Menu to display or configure the Trunk function. This section has the following items:

- **Link Aggregation Settings** Configure LACP configuration settings

4.8.1 Link Aggregation Settings

This page allows configuring Link Aggregation Settings. The Link Aggregation Settings screens in [Figure 4-8-2](#) appears.

Trunking Setting

System Priority	<input style="width: 80%;" type="text" value="1"/> (1~65535)
Link Aggregation Algorithm	<input style="width: 80%;" type="text" value="MAC Src&Dst"/>
<input type="button" value="Submit"/>	
<input type="button" value="Refresh"/>	

Link Group 3		
Member	P17	P18
	<input checked="" type="checkbox"/>	<input checked="" type="checkbox"/>
	--	--
State	<input style="width: 80%;" type="text" value="Disable"/>	
Type	<input style="width: 80%;" type="text" value="LACP"/>	
Operation Key	<input style="width: 80%;" type="text" value="3"/> (1~65535)	
Time Out	<input style="width: 80%;" type="text" value="Short Time Out"/>	
Activity	<input style="width: 80%;" type="text" value="Passive"/>	
<input type="button" value="Submit"/>		

Note: If you enable LACP on some specified ports and their link partners are normal port without LACP, these specified ports cannot transmit packet to/receive packet from the link partner.

Figure 4-8-2 LAG Setting Page Screenshot

The page includes the following fields:

Object	Description
<ul style="list-style-type: none"> • System Priority 	<p>The Priority controls the priority of the port.</p> <p>If the LACP partner wants to form a larger group than is supported by this device then this parameter will control which ports will be active and which ports will be in a backup role. Valid values are in the range 1 ~ 65535.</p> <p>Lower number means greater priority.</p>
<ul style="list-style-type: none"> • Link Aggregation Algorithm 	<p>Select load balance algorithm mode:</p> <p>MAC Address Source: The MAC Address Source can be used to calculate the</p>

	<p>port for the frame.</p> <p>MAC Address Source & Destination: The MAC Address Source & Destination can be used to calculate the port for the frame.</p>
• Member	Select port number for this drop down list to establish Link Aggregation.
• Status	<p>Indicates the LAG status operation. Possible statuses are:</p> <ul style="list-style-type: none"> ■ Enabled - Start up the LAG manually. ■ Disabled - Shutdown the LAG manually.
• Type	<p>Indicates the trunk type.</p> <ul style="list-style-type: none"> ■ Static: Force aggregated selected ports to be a trunk group. ■ LACP: LACP LAG negotiate Aggregated Port links with other LACP ports located on a different device. If the other device ports are also LACP ports, the devices establish a LAG between them.
• Operation Key	<p>The Key value incurred by the port, range 1-65535 . The Auto setting will set the key as appropriate by the physical link speed, 10Mb = 1, 100Mb = 2, 1Gb = 3.</p> <p>Using the Specific setting, a user-defined value can be entered. Ports with the same Key value can participate in the same aggregation group, while ports with different keys cannot.</p> <p>The default setting is "Auto"</p>
• Time Out	<p>The Timeout controls the period between BPDU transmissions.</p> <p>Short will transmit LACP packets each second, while Long will wait for 30 seconds before sending a LACP packet.</p>
• Activity	<p>The Role shows the LACP activity status. The Active will transmit LACP packets per second, while Passive will wait for a LACP packet from a partner (speak if spoken to).</p>

Buttons

Submit : Click to apply changes

Refresh : Click to refresh the page.

4.9 DHCP Relay Agent

Configure DHCP Relay on this Page. **DHCP Relay** is used to forward and to transfer DHCP messages between the clients and the server when they are not on the same subnet domain.

The **DHCP option 82** enables a DHCP relay agent to insert specific information into a DHCP request packets when forwarding client DHCP packets to a DHCP server and remove the specific information from a DHCP reply packets when forwarding server DHCP packets to a DHCP client. The DHCP server can use this information to implement IP address or other assignment policies. Specifically the option works by setting two sub-options:

- Circuit ID (option 1)
- Remote ID (option2).

The Circuit ID sub-option is supposed to include information specific to which circuit the request came in on.

The Remote ID sub-option was designed to carry information relating to the remote host end of the circuit.

The definition of Circuit ID in the switch is 4 bytes in length and the format is "vlan_id" "module_id" "port_no". The parameter of "vlan_id" is the first two bytes representing the VLAN ID. The parameter of "module_id" is the third byte for the module ID (in standalone switch it always equals 0; in stackable switch it means switch ID). The parameter of "port_no" is the fourth byte and it means the port number.

The Remote ID is 6 bytes in length, and the value equals the DHCP relay agent's MAC address.

4.9.1 DHCP Relay Agent

This page allows configuring DHCP Relay Agent Settings. The Link Aggregation Settings screens in [Figure 4-9-1](#) appears.



DHCP Relay Agent	
DHCP Relay State :	Disable ▼
DHCP Relay Hops Count Limit (1-16):	16
DHCP Relay Option 82 State :	Disable ▼
<input type="button" value="Apply"/>	

Figure 4-9-1 DHCP Relay Configuration Page Screenshot

The Page includes the following fields:

Object	Description
<ul style="list-style-type: none"> • DHCP Relay Status 	Indicates the DHCP relay mode operation. Possible modes are:

	<p>Enabled: Enable DHCP relay mode operation. When enabling DHCP relay mode operation, the agent forwards and transfers DHCP messages between the clients and the server when they are not on the same subnet domain. And the DHCP broadcast message won't flood for security considered.</p> <p>Disabled: Disable DHCP relay mode operation.</p>
<ul style="list-style-type: none"> • DHCP Relay Hops Count Limit (1-16) 	Configure the DHCP Relay Hops Count Limit settings.
<ul style="list-style-type: none"> • DHCP Relay Option 82 Status 	<p>Indicates the DHCP relay information mode option operation. Possible modes are:</p> <p>Enabled: Enable DHCP relay information mode operation. When enabling DHCP relay information mode operation, the agent inserts specific information (option82) into a DHCP message when forwarding to DHCP server and removing it from a DHCP message when transferring to DHCP client. It only works under DHCP relay operation mode enabled.</p> <p>Disabled: Disable DHCP relay information mode operation.</p>

Button

 : Click to apply changes

4.9.2 DHCP Relay Server

This page allows configuring DHCP Relay Server Settings. The DHCP Relay Server settings screens in [Figure 4-9-2](#) appears.



Figure 4-9-2 DHCP Relay Configuration Page Screenshot

The page includes the following fields:

Object	Description
<ul style="list-style-type: none"> • DHCP Server IP 	Configure the DHCP Server IP settings.

The DHCP Relay Server Status screen in [Figure 4-9-3](#) appears.

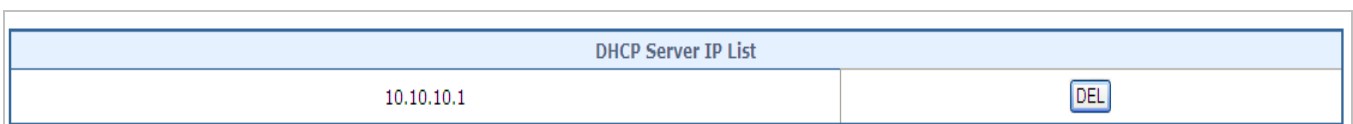

Figure 4-9-3 DHCP Relay Server Status Page Screenshot

The page includes the following fields:

Object	Description
• DHCP Server IP List	Display DHCP Server IP tables

Buttons

Add: Click to add changes

DEL: Click to delete changes

4.9.3 VLAN MAP Relay Agent

This page allows configuring VLAN MAP Relay Agent Settings. The VLAN MAP Relay Agent settings screens in [Figure 4-9-4](#) appears.

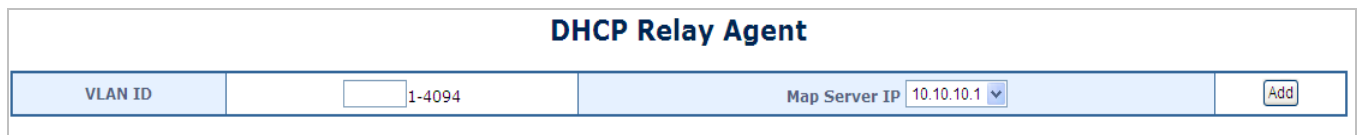

DHCP Relay Agent

VLAN ID	<input type="text" value="1-4094"/>	Map Server IP	<input type="text" value="10.10.10.1"/>	<input type="button" value="Add"/>
---------	-------------------------------------	---------------	---	------------------------------------

Figure 4-9-4 VLAN MAP Relay Agent Configuration Page Screenshot

The Page includes the following fields:

Object	Description
• VLAN ID	Indicates the VLAN ID of this particular VLAN.
• Map Server IP	Indicates the DHCP Server IP of this particular VLAN.

The MAP List screen in [Figure 4-9-5](#) appears.

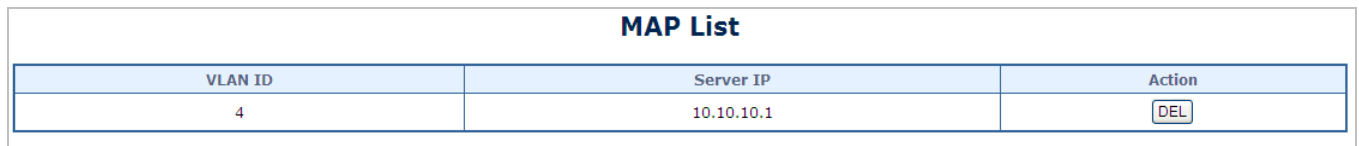

MAP List

VLAN ID	Server IP	Action
4	10.10.10.1	<input type="button" value="DEL"/>

Figure 4-9-5 MAP List Page Screenshot

The page includes the following fields:

Object	Description
• VLAN ID	Display VLAN ID of DHCP Relay Agent
• Map Server IP	Display DHCP Server IP address of DHCP Relay Agent

Buttons

: Click to add changes

: Click to delete changes

4.10 PoE Setting

The 8/16/24-Port 10/100TX 802.3at PoE + 2-Port Gigabit TP/SFP Combo Web Smart Ethernet Switch can easily build a power central-controlled IP phone system, IP camera system and AP group for the enterprise. For instance, cameras / APs can be easily installed around the corner in the company for surveillance demands or build a wireless roaming environment in the office. Without the power-socket limitation, the 8/16/24-Port 10/100TX 802.3at PoE + 2-Port Gigabit TP/SFP Combo Web Smart Ethernet Switch makes the installation of cameras or WLAN APs easier and more efficient.

PoE Power Budget list for PoE Web Smart Switch

Model Name	PoE Budget @ 25 degrees C	PoE Budget @ 50 degrees C
FGSD-1008HPS	125 watts	125 watts
FGSW-1816HPS	220 watts	220 watts
FGSW-2624HPS	220 watts	190 watts
FGSW-2624HPS4	420 watts	420 watts

PD Classifications

A PD may be classified by the PSE based on the classification information provided by the PD. The intent of PD classification is to provide information about the maximum power required by the PD during operation. However, to improve power management at the PSE, the PD provides a signature about **Class level**.







The PD is classified based on power. The classification of the PD is the maximum power that the PD will draw across all input voltages and operational modes.

A PD will return Class 0 to 4 in accordance with the maximum power draw as specified by [Table 4-10-1](#).

Class	Usage	Range of maximum power used by the PD	Class Description
0	Default	12.95 watts (or to 15.4 watts for AF mode) 25.5 watts (or to 30.8 watts for AT mode)	Mid power or High power
1	Optional	0.44 to 3.84 watts	Very low power
2	Optional	3.84 to 6.49 watts	Low power
3	Optional	6.49 to 12.95 watts (or to 15.4 watts)	Mid power
4	Optional	12.95 to 25.50 watts (or to 30.8 watts)	High power

Table 4-10-1 Device Class

4.10.1 Power over Ethernet Powered Device

 <p>3~5 watts</p>	<p>Voice over IP Phones</p> <p>Enterprise can install POE VoIP Phone, ATA and other Ethernet/non-Ethernet end-devices to the central where UPS is installed for un-interrupt power system and power control system.</p>
 <p>6~12 watts</p>	<p>Wireless LAN Access Points</p> <p>Museum, Sightseeing, Airport, Hotel, Campus, Factory, Warehouse can install the Access Point any where with no hesitation</p>
 <p>10~12 watts</p>	<p>IP Surveillance</p> <p>Enterprise, Museum, Campus, Hospital, Bank, can install IP Camera without limits of install location – no need electrician to install AC sockets.</p>
 <p>3~12 watts</p>	<p>PoE Splitter</p> <p>PoE Splitter split the PoE 48V DC over the Ethernet cable into 5/12V DC power output. It frees the device deployment from restrictions due to power outlet locations, which eliminate the costs for additional AC wiring and reduces the installation time.</p>
 <p>3~25 watts</p>	<p>High Power PoE Splitter</p> <p>High PoE Splitter split the PoE 52V DC over the Ethernet cable into 24/12V DC power output. It frees the device deployment from restrictions due to power outlet locations, which eliminate the costs for additional AC wiring and reduces the installation time.</p>
 <p>30 watts</p>	<p>High Power Speed Dome</p> <p>This state-of-the-art design is considerable to fit in various network environments like traffic centers, shopping malls, railway stations, warehouses, airports, and production facilities for the most demanding outdoor surveillance applications -- no need electrician to install AC sockets.</p>

4.10.2 PoE Status

In a power over Ethernet system, operating power is applied from a power source (PSU-power supply unit) over the LAN infrastructure to **powered devices (PDs)**, which are connected to ports. Under some conditions, the total output power required by PDs can exceed the maximum available power provided by the PSU. The system may a prior be planed with a PSU capable of supplying less power than the total potential power consumption of all the PoE ports in the system. In order to maintain the majority of ports active, power management is implemented.

The PSU input power consumption is monitored by measuring voltage and current .The input power consumption is equal to the system's aggregated power consumption .The power management concept allows all ports to be active and activates additional ports, as long as the aggregated power of the system is lower than the power level at which additional PDs cannot be connected .When this value is exceeded, ports will be deactivated, according to user-defined priorities. The power budget is managed according to the following user-definable parameters: maximum available power, ports priority, maximum allowable power per port.

This section allows the user to see the current status of PoE; screen in [Figure 4-10-1](#) appears.

PoE Status	
Power Supply Budget	220[W]
System Operation Status	On
Current Power consumption	0[W]
PoE Temperature	
PoE Port Temperature1	51
PoE Port Temperature2	51

Figure 4-10-1 PoE Status Screenshot

The page includes the following fields:

Object	Description
• Power Supply Budget	Configure the total watts usage of PoE Switch.
• System Operation Status	Display the current System Operation Status.
• Current Power Consumption	Display the current Current Power Consumption.
• PoE Port 1~8 Temperature	Display the current operating temperature of PoE chip unit 1. The unit 1 is in charge of PoE Port-1~Port-8
• PoE Port 9~16 Temperature	Display the current operating temperature of PoE chip unit 2. The unit 1 is in charge of PoE Port-9~Port-16

4.10.3 PoE Port Setting

This section allows the user to inspect and configure the current PoE port settings as [Figure 4-10-2](#) shows.

PoE Setting

Function	Status	Mode	Priority	Power Allocation
	<input type="checkbox"/> <input type="checkbox"/> <input type="checkbox"/> <input type="checkbox"/> <input type="checkbox"/>	<input type="checkbox"/> <input type="checkbox"/> <input type="checkbox"/> <input type="checkbox"/> <input type="checkbox"/>	<input type="text"/> (Critical: 1;High: 2;Low: 3)	<input type="text"/> [W](max:36 Watts)
Port No.	01 <input type="checkbox"/> 02 <input type="checkbox"/> 03 <input type="checkbox"/> 04 <input type="checkbox"/> 05 <input type="checkbox"/> 06 <input type="checkbox"/> 07 <input type="checkbox"/> 08 <input type="checkbox"/> 09 <input type="checkbox"/> 10 <input type="checkbox"/> 11 <input type="checkbox"/> 12 <input type="checkbox"/> 13 <input type="checkbox"/> 14 <input type="checkbox"/> 15 <input type="checkbox"/> 16 <input type="checkbox"/>			
<input type="button" value="Update"/>				

Figure 4-10-2 PoE Port Configuration Page Screenshot

The page includes the following fields:

Object	Description
<ul style="list-style-type: none"> • Status 	There are two modes for PoE status. <ul style="list-style-type: none"> ■ Enable: Enable PoE function. ■ Disable: Disable PoE function.
<ul style="list-style-type: none"> • Mode 	Allows user to select 802.3at or 802.3af compatibility mode. The default vaule is 802.3at mode. This function wil affect PoE power reservation on Classification power limit mode only, as 802.3af mode , system is going to reserve 15.4W maximum for PD that supported Class3 level. As IEEE 802.3at mode , system is going to reserve 30.8 watts for PD that support Class4 level. From class1 to class3 level on the 802.3at mode will be reserved the same PoE power with 802.3af mode.
<ul style="list-style-type: none"> • Priority 	The Priority represents PoE ports priority. There are three levels of power priority named 1 (Low), 2 (High) and 3 (Critical). The priority is used in the case when total power consumption has been over total power budget. In this case the port with the lowest priority will be turn off, and offer power for the port of higher priority. <ul style="list-style-type: none"> ■ 1: Low mode. ■ 2: High mode. ■ 3: Critical mode.
<ul style="list-style-type: none"> • Power Allocation 	It can limit the port PoE supply watts. Per port maximum value must less than 30.8 watts , total ports values must less than the Power Reservation value. Once power overload detected, the port will auto shut down and keep on detection mode until PD's power consumption lower than the power limit value
<ul style="list-style-type: none"> • Port No. 	Select the ports to apply the PoE Port Setting

The PoE Port Status screen in [Figure 4-10-3](#) appears.

Port Status						
Port	Status	Mode	Class	Priority	Power Used[W]	Power Allocation(Watt)
1	Enable	AT	---	3	0.00	30
2	Enable	AT	---	3	0.00	30
3	Enable	AT	---	3	0.00	30
4	Enable	AT	---	3	0.00	30
5	Enable	AT	---	3	0.00	30
6	Enable	AT	---	3	0.00	30
7	Enable	AT	---	3	0.00	30
8	Enable	AT	---	3	0.00	30
9	Enable	AT	---	3	0.00	30
10	Enable	AT	---	3	0.00	30
11	Enable	AT	---	3	0.00	30
12	Enable	AT	---	3	0.00	30
13	Enable	AT	---	3	0.00	30
14	Enable	AT	---	3	0.00	30
15	Enable	AT	---	3	0.00	30
16	Enable	AT	---	3	0.00	30

Figure 4-10-3 PoE Port Status Page Screenshot

The page includes the following fields:

Object	Description
• Port	This is the logical port number for this row.
• Status	Display Port Status of PoE Port Setting
• Mode	Display per PoE port operate at 802.3af or 802.3at mode.
• Class	Display the class of the PD attached to the port, as established by the classification process. Class 0 is the default for PDs. The PD is powered based on PoE Class level if system working on Classification mode. A PD will return Class to 0 to 4 in accordance with the maximum power draw as specified by Table 4-10-1 .
• Priority	The Priority shows the port's priority configured by the user.
• Power Used [W]	The Power Used shows how much power the PD currently is using.
• Power Allocation [W]	Display PoE port maximum output value of PoE Port Setting

Button

 : Click to apply changes

4.10.4 Port Sequential

This page allows the user to configure the PoE Ports started up interval time. PoE delay is to delay power feeding when the switch is completely booted up as [Figure 4-10-4](#) shows.

PoE Power Delay

Function	Delay Mode	Delay Time(0 ~ 300)seconds
	<input type="checkbox"/> <input type="button" value="v"/>	<input type="text" value=""/> [S]
Port No.	01 <input type="checkbox"/> 02 <input type="checkbox"/> 03 <input type="checkbox"/> 04 <input type="checkbox"/> 05 <input type="checkbox"/> 06 <input type="checkbox"/> 07 <input type="checkbox"/> 08 <input checked="" type="checkbox"/> 09 <input type="checkbox"/> 10 <input type="checkbox"/> 11 <input type="checkbox"/> 12 <input type="checkbox"/> 13 <input type="checkbox"/> 14 <input type="checkbox"/> 15 <input type="checkbox"/> 16 <input type="checkbox"/>	
<input type="button" value="Apply"/>		

Figure 4-10-4 PoE Port Sequential Configuration Screenshot



The PoE port will start providing power after the whole system program has finished running.

The page includes the following fields:

Object	Description
<ul style="list-style-type: none"> • Delay Mode 	Allows user to enable or disable Sequential Power up function. The default is Disable.
<ul style="list-style-type: none"> • Delay Time (0 ~ 300) seconds 	Allows user to configure the PoE Port Start Up interval time.
<ul style="list-style-type: none"> • Port No. 	Select the ports to apply the Port Sequential function

The PoE Port Sequential Setting Status screen in [Figure 4-10-5](#) appears.

Port	Delay Mode	Delay Time [S]
1	Disable	0
2	Disable	0
3	Disable	0
4	Disable	0
5	Disable	0
6	Disable	0
7	Disable	0
8	Disable	0
9	Disable	0
10	Disable	0
11	Disable	0
12	Disable	0
13	Disable	0
14	Disable	0
15	Disable	0
16	Disable	0

Figure 4-10-5 PoE Port Sequential Setting Status Page Screenshot

The page includes the following fields:

Object	Description
• Port	This is the logical port number for this row.
• Delay Mode	Display delay mode of Port Sequential.
• Delay Time [S]	Display delay interval time of Port Sequential.

Button

 : Click to apply changes

4.11 Configuration Backup / Upload

This page provides Backup/Recovery of PoE Web Smart Ethernet Switch; the screen in Figure 4-11-1 appears.

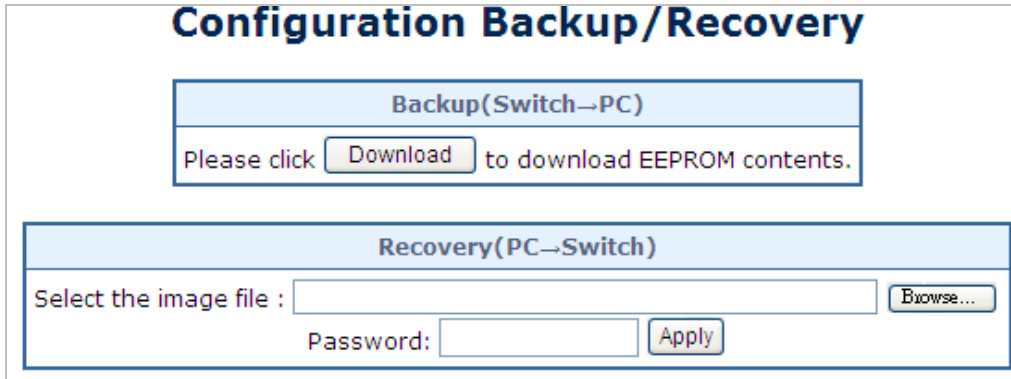

Figure 4-11-1 PoE Schedule Screenshot

The page includes the following fields:

Object	Description
• Backup (Switch → PC)	Allow to backup current configuration to PC.
• Recovery (PC → Switch)	Allow to recovery current configuration to switch. Use “Browser” button to select file which you want to reload to switch and type in the switch password.

Buttons

Apply : Click to apply changes

Download : Click to download the configure file.

Browse... : Click to find the configure file for recovery.

4.12 Misc Operation

The **Internet Group Management Protocol (IGMP)** lets host and routers share information about multicast groups memberships. IGMP snooping is a switch feature that monitors the exchange of IGMP messages and copies them to the CPU for feature processing. The overall purpose of IGMP Snooping is to limit the forwarding of multicast frames to only ports that are a member of the multicast group.

About the Internet Group Management Protocol (IGMP) Snooping

Computers and network devices that want to receive multicast transmissions need to inform nearby routers that they will become members of a multicast group. The **Internet Group Management Protocol (IGMP)** is used to communicate this information. IGMP is also used to periodically check the multicast group for members that are no longer active. In the case where there is more than one multicast router on a sub network, one router is elected as the 'queried'. This router then keeps track of the membership of the multicast groups that have active members. The information received from IGMP is then used to determine if multicast packets should be forwarded to a given sub network or not. The router can check, using IGMP, to see if there is at least one member of a multicast group on a given subnet work. If there are no members on a sub network, packets will not be forwarded to that sub network.

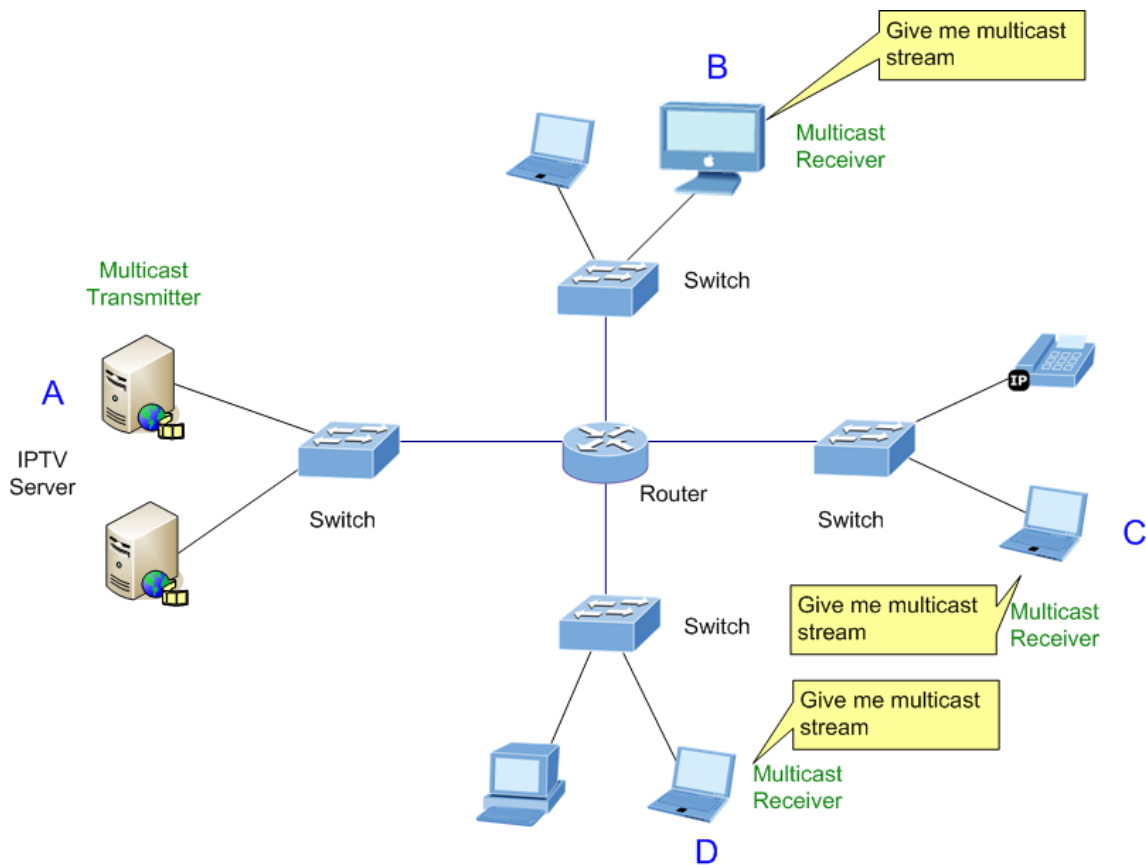

Figure 4-12-1 Multicast Service

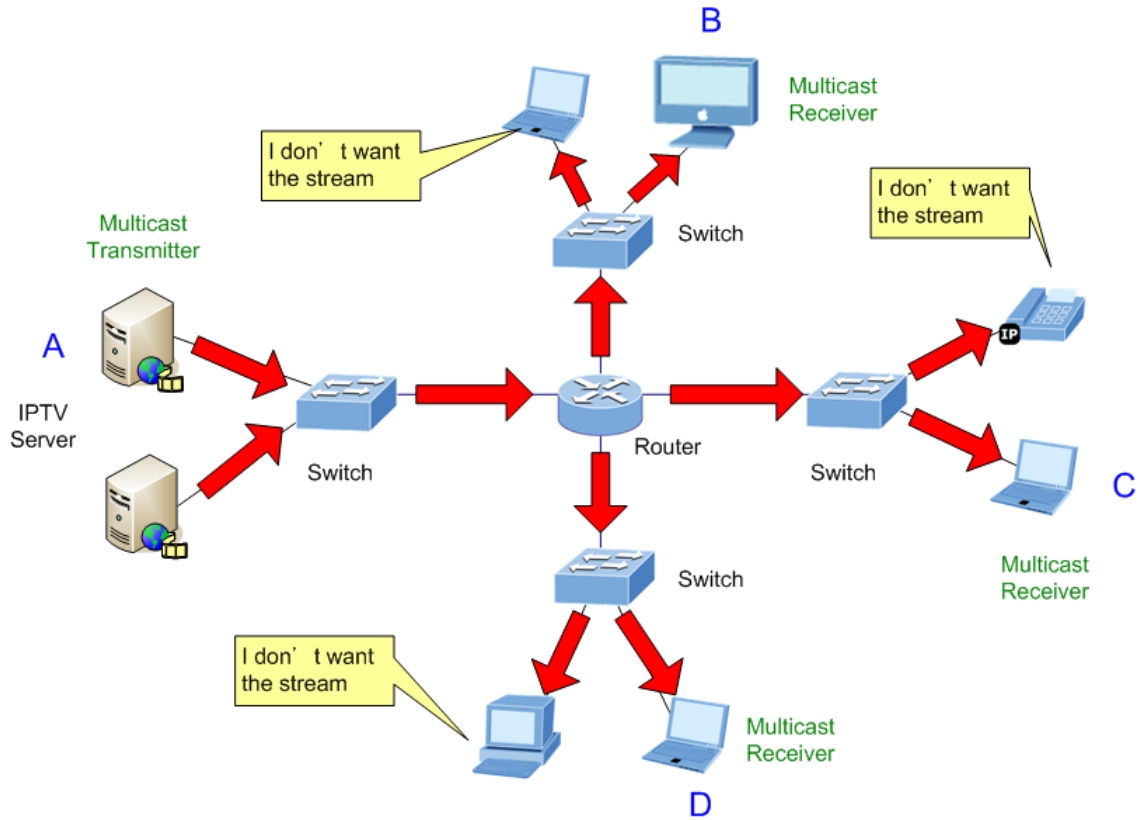

Figure 4-12-2 Multicast Flooding

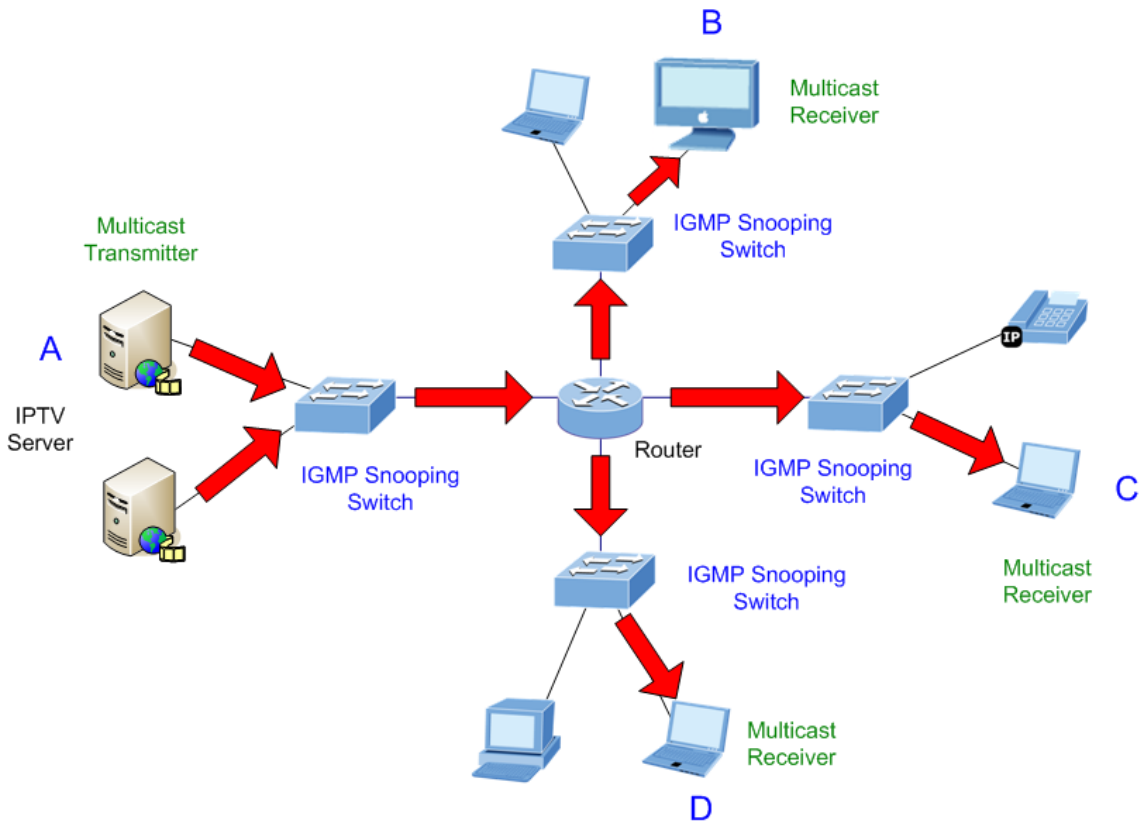

Figure 4-12-3 IGMP Snooping Multicast Stream Control

IGMP Versions 1 and 2

Multicast groups allow members to join or leave at any time. IGMP provides the method for members and multicast routers to communicate when joining or leaving a multicast group.

IGMP version 1 is defined in RFC 1112. It has a fixed packet size and no optional data.

The format of an IGMP packet is shown below:

IGMP Message Format

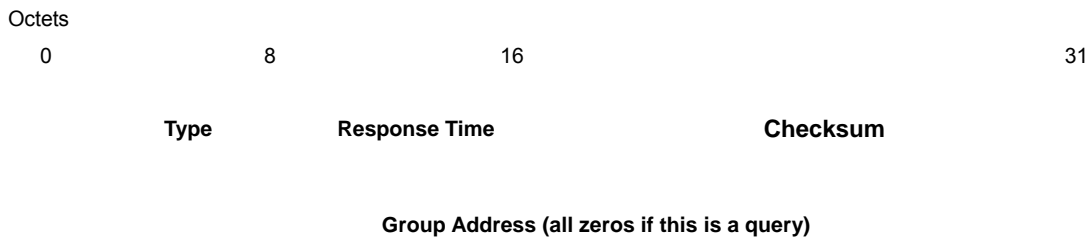

The IGMP Type codes are shown below:

Type	Meaning
0x11	Membership Query (if Group Address is 0.0.0.0)
0x11	Specific Group Membership Query (if Group Address is Present)
0x16	Membership Report (version 2)
0x17	Leave a Group (version 2)
0x12	Membership Report (version 1)

IGMP packets enable multicast routers to keep track of the membership of multicast groups, on their respective sub networks.

The following outlines what is communicated between a multicast router and a multicast group member using IGMP.

A host sends an IGMP “**report**” to join a group

A host will never send a report when it wants to leave a group (for version 1).

A host will send a “**leave**” report when it wants to leave a group (for version 2).

Multicast routers send IGMP queries (to the all-hosts group address: 224.0.0.1) periodically to see whether any group members exist on their sub networks. If there is no response from a particular group, the router assumes that there are no group members on the network.

The Time-to-Live (TTL) field of query messages is set to 1 so that the queries will not be forwarded to other sub networks.

IGMP version 2 introduces some enhancements such as a method to elect a multicast queried for each LAN, an explicit leave message, and query messages that are specific to a given group.

The states a computer will go through to join or to leave a multicast group are shown below:

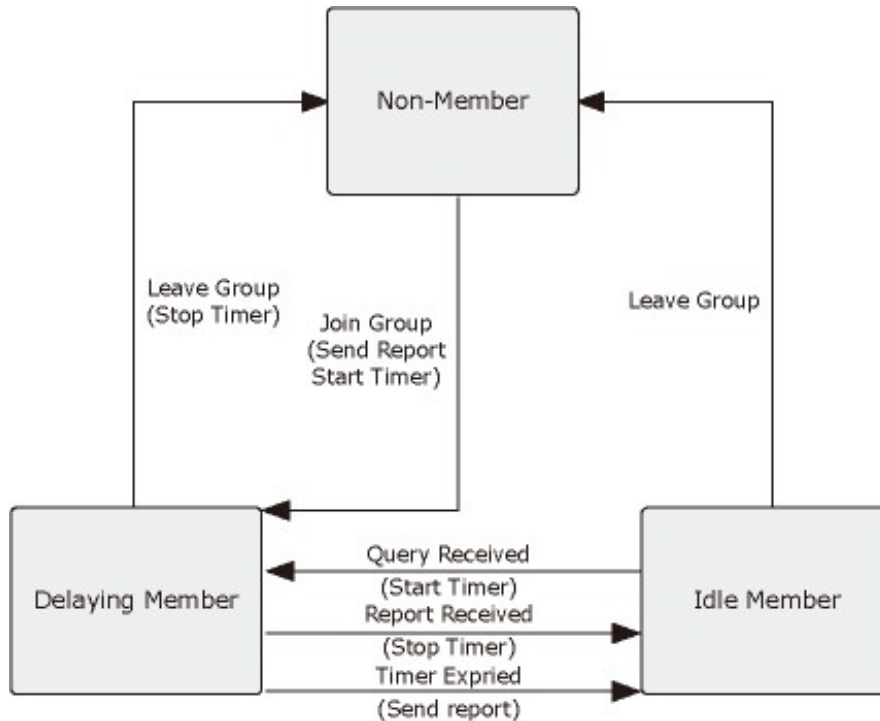

Figure 4-12-4 IGMP State Transitions

Configure Miscellaneous functions on this page. This section has the following items:

- **Output Queue Aging Time** Configure Output Queue Aging Time settings
- **VLAN Striding** Configure VLAN Striding settings
- **IGMP Snooping V1 & V2** Configure IGMP settings
- **VLAN Uplink Setting** Configure VLAN Uplink Setting

This page allows configuring Miscellaneous functions Settings. The Miscellaneous functions settings screen in [Figure 4-12-5](#) appears.

Misc Operation

Output Queue Aging Time	<input type="text" value="200"/> ms							
VLAN Striding								
VLAN Striding	<input type="text" value="Disable"/>							
IGMP Snooping V1 & V2								
IGMP Snooping	<input type="text" value="Disable"/>							
IGMP Snooping V1 & V2 function enable								
IGMP Leave Packet	<input type="text" value="Disable"/>							
VLAN Uplink Setting								
Port 01 <input type="radio"/> Uplink1 <input type="radio"/> Uplink2	Port 02 <input type="radio"/> Uplink1 <input type="radio"/> Uplink2	Port 03 <input type="radio"/> Uplink1 <input type="radio"/> Uplink2	Port 04 <input type="radio"/> Uplink1 <input type="radio"/> Uplink2	Port 05 <input type="radio"/> Uplink1 <input type="radio"/> Uplink2	Port 06 <input type="radio"/> Uplink1 <input type="radio"/> Uplink2	Port 07 <input type="radio"/> Uplink1 <input type="radio"/> Uplink2	Port 08 <input type="radio"/> Uplink1 <input type="radio"/> Uplink2	Port 09 <input type="radio"/> Uplink1 <input type="radio"/> Uplink2
Port 10 <input type="radio"/> Uplink1 <input type="radio"/> Uplink2	Port 11 <input type="radio"/> Uplink1 <input type="radio"/> Uplink2	Port 12 <input type="radio"/> Uplink1 <input type="radio"/> Uplink2	Port 13 <input type="radio"/> Uplink1 <input type="radio"/> Uplink2	Port 14 <input type="radio"/> Uplink1 <input type="radio"/> Uplink2	Port 15 <input type="radio"/> Uplink1 <input type="radio"/> Uplink2	Port 16 <input type="radio"/> Uplink1 <input type="radio"/> Uplink2	Port 17 <input type="radio"/> Uplink1 <input type="radio"/> Uplink2	Port 18 <input type="radio"/> Uplink1 <input type="radio"/> Uplink2
<input type="radio"/> Clear Uplink1 <input type="radio"/> Clear Uplink2								
<input type="button" value="Apply"/>								

Figure 4-12-5 Misc Operation Configuration Page Screenshot

The page includes the following fields:

Object	Description
<ul style="list-style-type: none"> • Aging time(ms) 	Use higher Output Queue Aging Time will have bad utilization of shared buffer and performance. Possible modes are: <ul style="list-style-type: none"> ■ Disabled: Disable Output Queue Aging Time operation ■ 200: Configure 200ms for the Output Queue Aging Time. ■ 400: Configure 400ms for the Output Queue Aging Time. ■ 600: Configure 600ms for the Output Queue Aging Time. ■ 800: Configure 800ms for the Output Queue Aging Time.
<ul style="list-style-type: none"> • VLAN Striding 	Indicates the VLAN Striding operation. Possible modes are: <ul style="list-style-type: none"> ■ Enabled: Switch will forward a uni-cast packet to the destination port. No matter whether the destination port is in the same VLAN group or not. ■ Disabled: Disable VLAN Striding operation
<ul style="list-style-type: none"> • IGMP Snooping 	Indicates the IGMP Snooping operation. Possible modes are: <ul style="list-style-type: none"> ■ Enabled: Enable IGMP Snooping operation ■ Disabled: Disable IGMP Snooping operation
<ul style="list-style-type: none"> • IGMP Leave Packet 	Indicates the IGMP Leave Packet operation. Possible modes are: <ul style="list-style-type: none"> ■ Enabled: Enable IGMP Leave Packet operation to send IGMP leave packet to IGMP router ports ■ Disabled: Disable IGMP Leave Packet operation
<ul style="list-style-type: none"> • VLAN Uplink Setting 	Select Uplink list for this port table, this function allows different VLAN use their individual uplink port to forward packets.

Button : Click to apply changes.

4.13 SNMP

The **Simple Network Management Protocol (SNMP)** is an application layer protocol that facilitates the exchange of management information between network devices. It is part of the **Transmission Control Protocol/Internet Protocol (TCP/IP)** protocol suite. SNMP enables network administrators to manage network performance, find and solve network problems, and plan for network growth.

An SNMP-managed network consists of three key components: Network management stations (NMSs), SNMP agents, Management information base (MIB) and network-management protocol :

- **Network management stations (NMSs)** : Sometimes called consoles, these devices execute management applications that monitor and control network elements. Physically, NMSs are usually engineering workstation-caliber computers with fast CPUs, megapixel color displays, substantial memory, and abundant disk space. At least one NMS must be present in each managed environment.
- **Agents** : Agents are software modules that reside in network elements. They collect and store management information such as the number of error packets received by a network element.
- **network-management protocol** : A management protocol is used to convey management information between agents and NMSs. SNMP is the Internet community's de facto standard management protocol.

SNMP Operations

SNMP itself is a simple request/response protocol. NMSs can send multiple requests without receiving a response.

1. **Get** -- Allows the NMS to retrieve an object instance from the agent.
2. **Set** -- Allows the NMS to set values for object instances within an agent.
3. **Trap** -- Used by the agent to asynchronously inform the NMS of some event. The SNMPv2 trap message is designed to replace the SNMPv1 trap message.

SNMP community

An SNMP community is the group that devices and management stations running SNMP belong to. It helps define where information is sent. The community name is used to identify the group. A SNMP device or agent may belong to more than one SNMP community. It will not respond to requests from management stations that do not belong to one of its communities. SNMP default communities are:

- **Read** = public

Configure SNMP functions on this page. This section has the following items:

- **Community Settings** Configure SNMP Community settings
- **SNMP Settings** Configure SNMP settings
- **SNMP Trap Settings** Configure SNMP Trap settings

This page allows configuring SNMP functions Settings. The SNMP functions Settings screen in [Figure 4-13-1](#) appears.

SNMP Settings

Community Settings	
Community Name	Access Right
<input type="text" value="public"/>	Read Only <input type="button" value="v"/>
<input type="text" value="private"/>	Read/Write <input type="button" value="v"/>
<input type="button" value="Update"/>	

SNMP Settings	
System Description	<input type="text" value="FGSW-1816HPS"/>
System Contact	<input type="text" value="PLANET"/>
System Location	<input type="text" value="PLANET"/>
<input type="button" value="Update"/>	

Figure 4-13-1 SNMP Configuration Page Screenshot

The page includes the following fields:

Object	Description
• Community Name	A string identifying the SNMP Community name that this entry should belong to.
• Access Right	Indicates the SNMP community type operation. Possible types are: RO=Read Only : Set access string type in read-only mode. RW=Read/Write : Set access string type in read-write mode.
• System Description	A string identifying the System Description name that this entry should belong to.
• System Contact	A string identifying the System Contact name that this entry should belong to.
• System Location	A string identifying the System Location name that this entry should belong to.
• Trap State	Indicates the SNMP Trap State operation. Possible types are: Enabled : Enable SNMP Trap State operation Disabled : Disable SNMP Trap State operation
• Enable Trap Server	Indicates the SNMP Trap Server operation. Possible types are: Enabled : Enable SNMP Trap Server operation Disabled : Disable SNMP Trap Server operation
• Trap Server Address	Configure the SNMP Trap Server IP address
• Trap Server Status	Display the SNMP Trap Server status

Button

: Click to apply changes

4.14 Logout

This page allows enabling Logout Settings. The Logout settings screen in [Figure 4-14-1](#) appears.

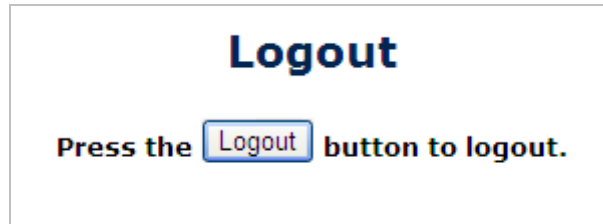
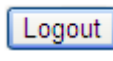

Figure 4-14-1 Logout Page Screenshot

Button

: Click to apply logout.

5. SWITCH OPERATION

5.1 Address Table

The Switch is implemented with an address table. This address table composed of many entries. Each entry is used to store the address information of some node in network, including MAC address, port no, etc. This information comes from the learning process of Ethernet Switch.

5.2 Learning

When one packet comes in from any port, the Switch will record the source address, port no. And the other related information in address table. This information will be used to decide either forwarding or filtering for future packets.

5.3 Forwarding & Filtering

When one packet comes from some port of the Ethernet Switching, it will also check the destination address besides the source address learning. The Ethernet Switching will lookup the address-table for the destination address. If not found, this packet will be forwarded to all the other ports except the port, which this packet comes in. And these ports will transmit this packet to the network it connected. If found, and the destination address is located at different port from this packet comes in, the Ethernet Switching will forward this packet to the port where this destination address is located according to the information from address table. But, if the destination address is located at the same port with this packet comes in, then this packet will be filtered.

Thereby increasing the network throughput and availability

5.4 Store-and-Forward

Store-and-Forward is one type of packet-forwarding techniques. A Store-and-Forward Ethernet Switching stores the incoming frame in an internal buffer, do the complete error checking before transmission. Therefore, no error packets occurrence, it is the best choice when a network needs efficiency and stability.

The Ethernet Switch scans the destination address from the packet-header, searches the routing table provided for the incoming port and forwards the packet, only if required. The fast forwarding makes the switch attractive for connecting servers directly to the network, thereby increasing throughput and availability. However, the switch is most commonly used to segment existence hubs, which nearly always improves overall performance. An Ethernet Switching can be easily configured in any Ethernet network environment to significantly boost bandwidth using conventional cabling and adapters.

Due to the learning function of the Ethernet switching, the source address and corresponding port number of each incoming and outgoing packet are stored in a routing table. This information is subsequently used to filter packets whose destination address is on the same segment as the source address. This confines network traffic to its respective domain and reduce the overall load on the network.

The Switch performs "Store and forward" therefore, no error packets occur. More reliably, it reduces the re-transmission rate. No packet loss will occur.

5.5 Auto-Negotiation

The STP ports on the Switch have built-in "Auto-negotiation". This technology automatically sets the best possible bandwidth when a connection is established with another network device (usually at Power On or Reset). This is done by detect the modes and speeds at the second of both device is connected and capable of, both 10BASE-T and 100BASE-TX devices can connect with the port in either Half- or Full-Duplex mode.

If attached device is:	100BASE-TX port will set to:
10Mbps, no auto-negotiation	10Mbps.
10Mbps, with auto-negotiation	10/20Mbps (10BASE-T/Full-Duplex)
100Mbps, no auto-negotiation	100Mbps
100Mbps, with auto-negotiation	100/200Mbps (100BASE-TX/Full-Duplex)

6. Power over Ethernet Overview

What is PoE?

The PoE is an abbreviation of Power over Ethernet; the PoE technology means a system to pass electrical power safely, along with data on Ethernet UTP cable. The IEEE standard for PoE technology requires Category 5 cable or higher for high power PoE levels, but can operate with category 3 cable for low power levels. Power is supplied in common mode over two or more of the differential pairs of wires found in the Ethernet cables and comes from a power supply within a PoE-enabled networking device such as an Ethernet switch or can be injected into a cable run with a mid-span power supply.

The original IEEE 802.3af-2003 PoE standard provides up to 15.4 W of DC power (minimum 44 V DC and 350mA) to each device. Only 12.95 W is assured to be available at the powered device as some power is dissipated in the cable. The updated IEEE 802.3at-2009 PoE standard also known as PoE+ or PoE plus, provides up to 25.5 W of power. The 2009 standard prohibits a powered device from using all four pairs for power. The 802.3af / 802.3at define two types of source equipment: Mid-Span and End-Span.

Mid-Span

Mid-Span device is placed between legacy switch and the powered device. Mid-Span is tap the unused wire pairs 4/5 and 7/8 to carry power, the other four is for data transmit.

End-Span

End-Span device is direct connecting with power device. End-Span could also tap the wire 1/2 and 3/6.

PoE System Architecture

The specification of PoE typically requires two devices: the **Powered Source Equipment (PSE)** and the **Powered Device (PD)**. The PSE is either an End-Span or a Mid-Span, while the PD is a PoE-enabled terminal, such as IP Phones, Wireless LAN, etc. Power can be delivered over data pairs or spare pairs of standard CAT-5 cabling.

Powered Source Equipment (PSE)

Power sourcing equipment (PSE) is a device such as a switch that provides (sources) power on the Ethernet cable. The maximum allowed continuous output power per cable in IEEE 802.3af is 15.40 W. A later specification, IEEE 802.3at, offers 25.50 W. When the device is a switch, it is commonly called an End-span (although IEEE 802.3af refers to it as endpoint). Otherwise, if it's an intermediary device between a non PoE capable switch and a PoE device, it's called a Mid-span. An external PoE injector is a Mid-span device

Powered device

A powered device (PD) is a device powered by a PSE and thus consumes energy. Examples include wireless access points, IP Phones, and IP cameras. Many powered devices have an auxiliary power connector for an optional, external, power supply. Depending on the PD design, some, none, or all power can be supplied from the auxiliary port, with the auxiliary port sometimes acting as backup power in case of PoE supplied power failure.

How Power is Transferred Through the Cable

A standard CAT5 Ethernet cable has four twisted pairs, but only two of these are used for 10BASE-T and 100BASE-TX. The specification allows two options for using these cables for power, shown in Figure 1 and Figure 2:

The spare pairs are used. Figure 1 shows the pair on pins 4 and 5 connected together and forming the positive supply, and the pair on pins 7 and 8 connected and forming the negative supply. (In fact, a late change to the spec allows either polarity to be

used).

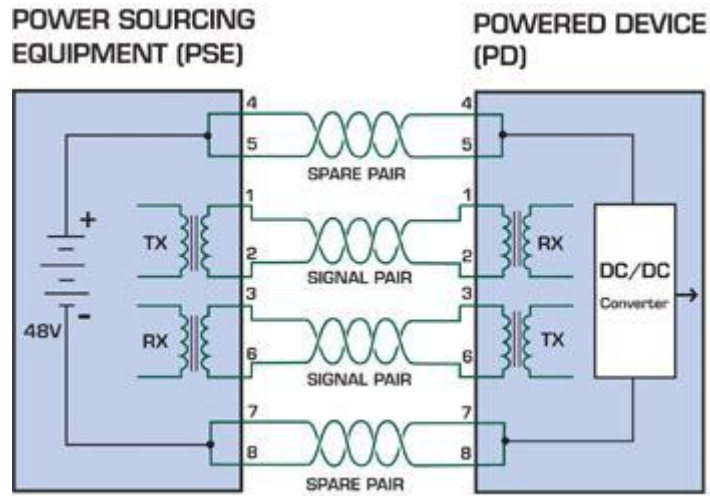

Figure 6-1: Power Supplied over the Spare Pins

The data pairs are used. Since Ethernet pairs are transformer coupled at each end, it is possible to apply DC power to the center tap of the isolation transformer without upsetting the data transfer. In this mode of operation the pair on pins 3 and 6 and the pair on pins 1 and 2 can be of either polarity.

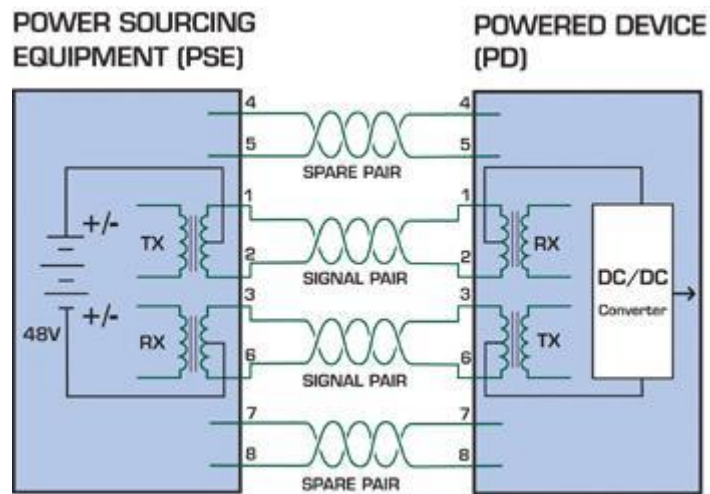

Figure 6-2: Power Supplied over the Data Pins

7. TROUBLESHOOTING

This chapter contains information to help you solve your issue. If the PoE Web Smart Switch is not functioning properly, make sure the PoE Web Smart Switch is set up according to instructions in this manual.

■ The Link LED is not lit

Solution:

Check the cable connection and remove duplex mode of the PoE Web Smart Switch.

■ Some stations cannot talk to other stations located on the other port

Solution:

Please check the VLAN settings, trunk settings, or port enabled / disabled status.

■ Performance is bad

Solution:

Check the full duplex status of the PoE Web Smart Switch. If the PoE Web Smart Switch is set to full duplex and the partner is set to half duplex, then the performance will be poor. Please also check the in/out rate of the port.

■ Why the Switch doesn't connect to the network

Solution:

1. Check the LNK/ACT LED on the PoE Web Smart Switch.
2. Try another port on the PoE Web Smart Switch.
3. Make sure the cable is installed properly.
4. Make sure the cable is the right type.
5. Turn off the power. After a while, turn on power again.

■ 100BASE-TX port link LED is lit, but the traffic is irregular

Solution:

Check that the attached device is not set to dedicate full duplex. Some devices use a physical or software switch to change duplex modes. Auto-negotiation may not recognize this type of full-duplex setting.

■ Switch does not power up

Solution:

- AC power cord not inserted or faulty
- Check whether the AC power cord is inserted correctly
- Replace the power cord if the cord is inserted correctly; check whether the AC power source is working by connecting a different device in place of the switch.
- If that device works, refer to the next step.

- If that device does not work, check the AC power.

APPENDIX A

A.1 Switch's RJ45 Pin Assignments

1000Mbps, 1000BASE T

Contact	MDI	MDI-X
1	BI_DA+	BI_DB+
2	BI_DA-	BI_DB-
3	BI_DB+	BI_DA+
4	BI_DC+	BI_DD+
5	BI_DC-	BI_DD-
6	BI_DB-	BI_DA-
7	BI_DD+	BI_DC+
8	BI_DD-	BI_DC-

Implicit implementation of the crossover function within a twisted-pair cable, or at a wiring panel, while not expressly forbidden, is beyond the scope of this standard.

A.2 10/100Mbps, 10/100BASE-TX

When connecting your 10/100Mbps Ethernet Switch to another switch, a bridge or a hub, a straight or crossover cable is necessary. Each port of the Switch supports auto-MDI/MDI-X detection. That means you can directly connect the Switch to any Ethernet devices without making a crossover cable. The following table and diagram show the standard RJ45 receptacle/connector and their pin assignments:

RJ45 Connector pin assignment		
Contact	MDI Media Dependent Interface	MDI-X Media Dependent Interface-Cross
1	Tx + (transmit)	Rx + (receive)
2	Tx - (transmit)	Rx - (receive)
3	Rx + (receive)	Tx + (transmit)
4, 5	Not used	
6	Rx - (receive)	Tx - (transmit)
7, 8	Not used	

The standard cable, RJ45 pin assignment

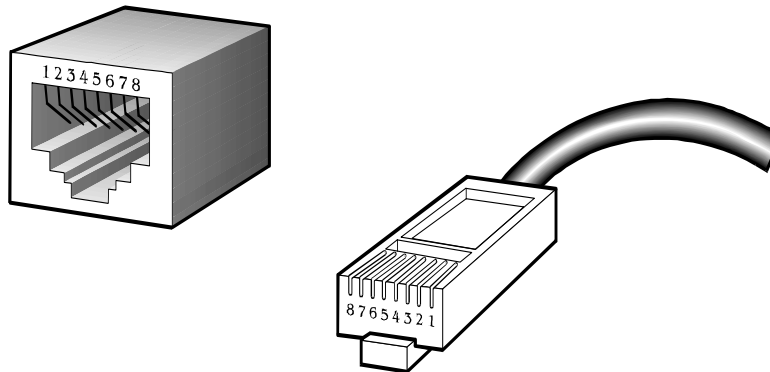

The standard RJ45 receptacle/connector

There are 8 wires on a standard UTP/STP cable and each wire is color-coded. The following shows the pin allocation and color of straight-through cable and crossover cable connection:

Straight-through Cable		SIDE 1	SIDE2
	SIDE 1	1 = White / Orange	1 = White / Orange
		2 = Orange	2 = Orange
		3 = White / Green	3 = White / Green
		4 = Blue	4 = Blue
		5 = White / Blue	5 = White / Blue
		6 = Green	6 = Green
		7 = White / Brown	7 = White / Brown
		8 = Brown	8 = Brown
Crossover Cable		SIDE 1	SIDE2
	SIDE 1	1 = White / Orange	1 = White / Green
		2 = Orange	2 = Green
		3 = White / Green	3 = White / Orange
		4 = Blue	4 = Blue
		5 = White / Blue	5 = White / Blue
		6 = Green	6 = Orange
		7 = White / Brown	7 = White / Brown
		8 = Brown	8 = Brown

Figure A-1: Straight-through and Crossover Cables

Please make sure your connected cables are with the same pin assignment and color as the above table before deploying the cables onto your network.

EC Declaration of Conformity

For the following equipment:

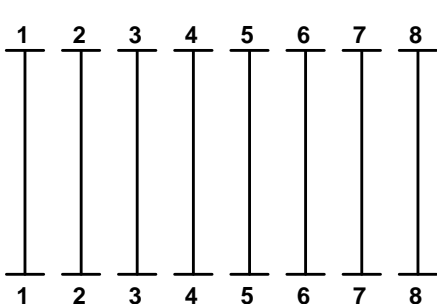
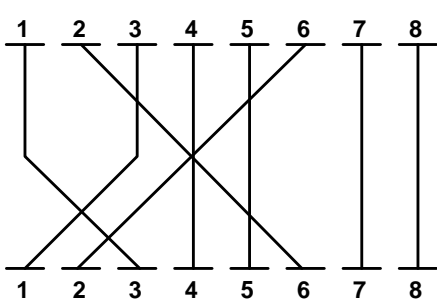
*Type of Product : 16-Port 10/100TX 802.3at PoE + 2-Port Gigabit TP/SFP ComboWeb Smart Ethernet Switch
*Model Number : FGSW-1816HPS
* Produced by:
Manufacturer's Name : **Planet Technology Corp.**
Manufacturer's Address : 10F., No.96, Minquan Rd., Xindian Dist.,
New Taipei City 231, Taiwan (R.O.C.).

is herewith confirmed to comply with the requirements set out in the Council Directive on the Approximation of the Laws of the Member States relating to Electromagnetic Compatibility Directive on (2004/108/EC) and Low Voltage Directive 2006/95/EC.

For the evaluation regarding the EMC, the following standards were applied:

EN 55022	(2010+AC: 2011)
EN 61000-3-2	(2006+A2:2009)
EN 61000-3-3	(2008)
EN 55024	(2010)
EN 61000-4-2	(2009)
EN 61000-4-3	(2006+A2:2010)
EN 61000-4-4	(2012)
EN 61000-4-5	(2006)
EN 61000-4-6	(2009)
EN 61000-4-8	(2010)
EN 61000-4-11	(2004)
EN60950-1	(2006+A11:2009+A1:2010+A12:2011+A2:2013)

Responsible for marking this declaration if the:

Manufacturer Authorized representative established within the EU

Authorized representative established within the EU (if applicable):

Company Name: Planet Technology Corp.

Company Address: 10F., No.96, Minquan Rd., Xindian Dist., New Taipei City 231, Taiwan (R.O.C.)

Person responsible for making this declaration

Name, Surname Kent Kang

Position / Title : Product Manager

Taiwan
Place

25th, Aug., 2014
Date

Legal Signature

PLANET TECHNOLOGY CORPORATION

e-mail: sales@planet.com.tw http://www.planet.com.tw

10F., No.96, Minquan Rd., Xindian Dist., New Taipei City, Taiwan, R.O.C. Tel:886-2-2219-9518 Fax:886-2-2219-9528

EC Declaration of Conformity

For the following equipment:

*Type of Product : 8-Port 10/100TX 802.3at PoE + 2-Port Gigabit TP/ SFP combo Web Smart Switch
*Model Number : FGSD-1008HPS
* Produced by:
Manufacturer's Name : **Planet Technology Corp.**
Manufacturer's Address : 10F., No.96, Minquan Rd., Xindian Dist.,
New Taipei City 231, Taiwan (R.O.C.).

is herewith confirmed to comply with the requirements set out in the Council Directive on the Approximation of the Laws of the Member States relating to Electromagnetic Compatibility Directive on (2004/108/EC) and Low Voltage Directive 2006/95/EC.

For the evaluation regarding the EMC, the following standards were applied:

EN 55022	(2010+AC: 2011)
EN 61000-3-2	(2006+A1:2009+A2:2009)
EN 61000-3-3	(2008)
EN 55024	(2010)
EN 61000-4-2	(2009)
EN 61000-4-3	(2006+A2:2010)
EN 61000-4-4	(2012)
EN 61000-4-5	(2006)
EN 61000-4-6	(2009)
EN 61000-4-8	(2010)
EN 61000-4-11	(2004)
EN60950-1	(2006+A11:2009+A1:2010+A12:2011+A2:2013)

Responsible for marking this declaration if the:

Manufacturer Authorized representative established within the EU

Authorized representative established within the EU (if applicable):

Company Name: Planet Technology Corp.

Company Address: 10F., No.96, Minquan Rd., Xindian Dist., New Taipei City 231, Taiwan (R.O.C.)

Person responsible for making this declaration

Name, Surname Kent Kang

Position / Title : Product Manager

Taiwan
Place

12th, June, 2015
Date

Legal Signature

PLANET TECHNOLOGY CORPORATION

e-mail: sales@planet.com.tw http://www.planet.com.tw

10F., No.96, Minquan Rd., Xindian Dist., New Taipei City, Taiwan, R.O.C. Tel:886-2-2219-9518 Fax:886-2-2219-9528