



Operating Manual

A 4505D Lockdown Timer

Optional Accessories

- A 4498** Network Connection Pack
- A 4658** Power Injector (U/UTP Cat5)
- A 2064** Lockdown/Fire/Cancel Remote Wall Plate (Hard Wired)
- A 2069** Lockdown/Fire/Bell/Cancel Remote Wall Plate (Hard Wired)
- A 4579** Timer Isolate Remote Wall Plate (U/UTP Cat5)
- A 4599** Lockdown/Fire/Bell/Cancel Remote Wall Plate (U/UTP Cat5)
- A 4599V** Lockdown/Fire/Bell/Cancel Remote Wall Plate (U/UTP Cat5)
- A 4660A** Emergency Paging Microphone Console (U/UTP Cat5)



User manual revision number: 1.1 26/10/2025

Distributed by Altronic Distributors Pty. Ltd.

Phone: 1300 780 999 Fax: 1300 790 999 Internet: www.altronic.com.au

IMPORTANT NOTE:

Please read these instructions carefully from front to back prior to installation. They include important setup instructions. Failure to follow these instructions may prevent the unit from working as designed.



REDBACK is a registered trademark of Altronic Distributors Pty Ltd

You may be surprised to learn that Altronic is still manufacturing hundreds of product lines right here in Australia. We have resisted the move offshore by offering our customers better quality products with innovations to save them time and money.

Our Balcatta production facility manufactures/assembles:

- Redback public address products
- One-shot speaker & grill combinations
- Zip-Rack 19 inch rack frame products

We strive to support local suppliers wherever possible in our supply chain, helping to support Australia's manufacturing industry.

Redback Audio Products

100% developed, designed & assembled in Australia.

Since 1976 we have been manufacturing Redback amplifiers in Perth, Western Australia. With over 40 years experience in the commercial audio industry, we offer consultants, installers and end users reliable products of high build quality with local product support. We believe there is significant added value for customers when purchasing an Australian made Redback amplifier or PA product.

Local support & feedback.

Our best product features come as a direct result of feedback from our customers, and when you call us, you speak to a real person - no recorded messages, call centres or automated push button options. It's not only the assembly team at Altronic who are employed as a direct result of your purchase, but hundreds more at local companies used in the supply chain.

Industry leading 10 year warranty.

There's a reason we have the industry leading DECADE warranty. It's because of a long tried and tested history of bullet-proof reliability. We've heard PA contractors tell us they still see the original Redford amplifier still in service in schools.

We offer this comprehensive parts & labour warranty on almost every Australian Made Redback public address product. This offers both installers and end users peace of mind that they will receive prompt local servicing in the rare event of any problems.

Published by Altronic Distributors
© 2025 Altronic Distributors

CONTENTS

	Page
1.0 Overview	
1.1 Introduction	4
1.2 Features	4
1.3 What's in the box	4
1.4 Front panel guide	5
1.5 Rear panel connections	6
2.0 Setup	
2.1 Initial Setup	8
2.2 Lockdown, Fire and Bell Switches	8
2.3 Setting the current time	8
2.4 Programming The Timing Events Using The Supplied PC Software	10
2.5 Programming The Timing Events Using The Front Button	10
2.6 Deleting A Programmed Time	11
2.7 Reset All Programmed Times	11
2.8 EV Chanegover	12
2.9 Play Prebell	12
2.10 Play Music	12
2.11 Audio Connections	12
2.12 DIP Switch settings	13
2.13 24V DC Output Connections	13
3.0 Network Access	14
4.0 Remote Wall Plates	
4.1 A 2064 and A 2069 Remote Plates	15
4.2 A 4599 and A 4599V Remote Plate	16
5.0 Paging Console	
5.1 A 4660A Overview	18
5.2 A 4660A Settings Menu	18
5.2.1 System Settings	19
5.2.2 Backlight Settings	19
5.2.3 PIN Access	20
5.2.4 Installer Label	20
5.2.5 Microphone Settings	20
4.3 Connecting the Paging Console	21
6.0 Troubleshooting	
6.1 Symptoms and Remedies	22
6.2 RJ45 Cabling Configuration	23
7.0 Firmware Update	23
8.0 Specifications & Warranty	24

1.0 OVERVIEW

1.1 INTRODUCTION

The Redback® A 4505D is a weekly timer and Lockdown and Fire Alarm controller all housed in a convenient 1RU rack mount chassis. A total of 50 "event" switching times are available through the timing functions. Each event can be set to turn on any single day of the week or on multiple days, from 1 sec up to 24 hours. When a timing event is activated, an audio file will be played and output through the RCA line level output. There are one 99 audio playback options for the timing events, which include the Bell, Prebell, Music and outputs 5-99. A Micro SD card which is supplied, houses all the audio files to be played as well as storing all the timing events. The timing events can be programmed via the unit's front buttons which is a bit cumbersome, or they can be programmed with the supplied PC software (also available as a download from www.altronics.com.au or www.redbackaudio.com.au).

The timing events can also be programmed to activate only a relay with no audio output. This is activated by setting the output to the "relay" option in the programming setup. Once activated the common 24V Out will become active.

The Lockdown/Fire controller is designed around industry standard building emergency Lockdown/Fire requirements. When connected to a paging system amplifier, building occupants can be alerted and/or evacuated in the event of an emergency e.g. fire, gas leak, bomb scare, earthquake. Lockdown & Fire switches on the front of the unit are fitted with safety covers to prevent accidental operation.

The Lockdown, Fire and Bell tones and the cancel function are triggered by the front switches, or by the rear terminal contacts for remote activation. Switched 24V DC Out connections are provided for Bell, Lockdown, Fire or a Common out. These contacts are for connection of override relays in remote volume controls, warning strobes, bells etc.

The Lockdown and Fire tones are stored on a Micro SD card (Emergency Tones which conform to AS1670.4 are supplied) to allow the user to provide any tones they require (Note: The audio files must be in MP3 format).

The Fire mode has a voice over option for the playback of a Fire message after every playback of the Fire tone. The voice over message is also stored on the SD card and is DIP switch enabled.

The Lockdown mode has a voice over option for the playback of a Lockdown message after every playback of the Lockdown tone. The voice over message is also stored on the SD card and is DIP switch enabled.

(Note: The audio files must be in MP3 format and are converted by the supplied PC software to work with the timer).

1.2 FEATURES

- MP3 audio format for Bell, Prebell and Music timing outputs
- MP3 audio format Emergency Tones conform to AS 1670.4 (supplied)
- Random play of MP3 files for Prebell and Music triggers
- Easy PC based timing event setup
- Local push button operation of Lockdown, Fire and Bell
- Remote triggering of Lockdown, Fire and Bell
- MP3 audio format Voice over message (Available in the Lockdown and the Fire cycle)
- Switched 24VDC output for Bell, Lockdown or Fire mode
- Pluggable screw terminal connections
- Auxiliary level output
- Battery backup of current time
- 24V DC operation
- Standard 1U 19" rack mount case
- Suitable for any amplifier with an auxiliary input
- 10 Year Warranty
- Australian Designed and Manufactured

1.3 WHAT'S IN THE BOX

Redback® A 4505D Lockdown Timer
24V DC Plugpack
Instruction Booklet

1.4 FRONT PANEL GUIDE

Fig 1.4A shows the layout of the A 4505D front panel.

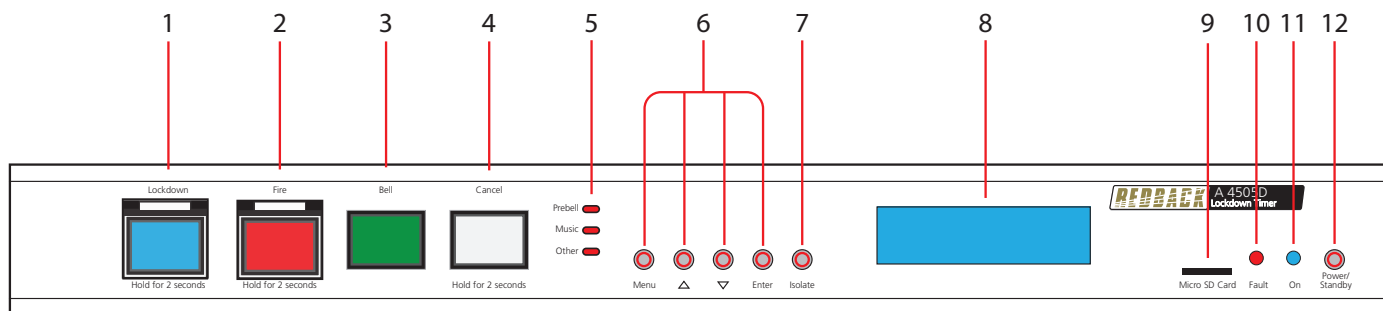

Fig 1.4A

1 Lockdown Tone Activation Switch

This switch is used to activate the Lockdown tone. It may need to be pressed for up to 2 seconds to activate.

2 Fire Tone Activation Switch

This switch is used to activate the Fire tone. It may need to be pressed for up to 2 seconds to activate.

3 Bell Tone Activation Switch

This switch is used to activate the Bell tone.

4 Cancel Tone Activation Switch

This switch is used to cancel the Lockdown, Fire or bell tone. It may need to be pressed for up to 2 seconds to activate.

5 Status LEDs

Prebell LED - This LED indicates when the Prebell is active.

Music LED - This LED indicates when an MP3 from the Music Folder is active.

Other LED - This LED indicates when an MP3 from one of the Music Folders 5 - 99 is active.

6 Menu and Navigation Switches

These switches are used to navigate the menu functions of the unit.

7 Isolate Switch

This switch is used to isolate the timing functions of the unit. Note: When this is enabled the Lockdown, Fire and Chime buttons and remote triggers will still function.

8 LCD Display

This displays the current time and other timing functions.

9 Micro SD Card

This is used to store the audio files for playback of the timing events and the PC programming software.

10 Fault Indicator

This LED indicates that the unit has a fault.

11 On Indicator

This LED indicates the unit is ON.

12 Standby Switch

When the unit is in standby mode this switch will illuminate. Press this button to switch the unit ON. Once the unit is ON the On indicator will illuminate. Press this switch again to put the unit back in standby mode.

Redback® A 4505D Lockdown Timer with Network Access

1.5 REAR PANEL CONNECTIONS

Fig 1.5 shows the layout of the A 4505D rear panel.

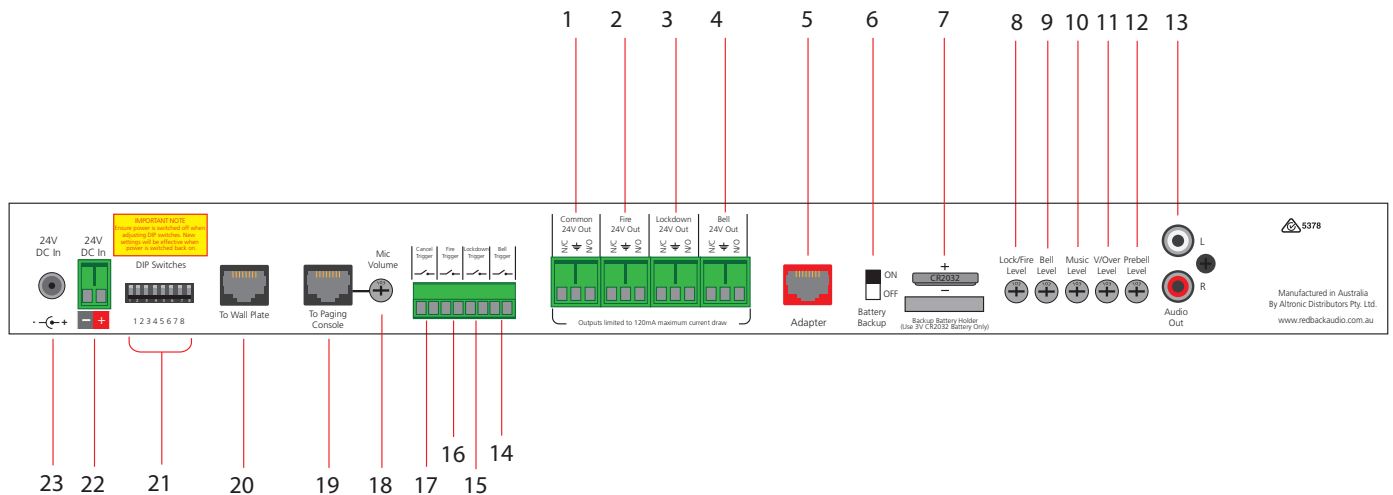

Fig 1.5

1 Common 24V Out

This is a common 24V DC output which is activated when any of the Prebell, Bell, Music, Lockdown or Fire tones are activated. The terminals provided can be used for “Normal” or “Failsafe” modes (see section 2.12 for more details).

2 Fire 24V Out

This is a 24V DC output which is activated when the Fire tone is activated. The terminals provided can be used for “Normal” or “Failsafe” modes (see section 2.12 for more details).

3 Lockdown 24V Out

This is a 24V DC output which is activated when the Lockdown tone is activated. The terminals provided can be used for “Normal” or “Failsafe” modes (see section 2.12 for more details).

4 Bell 24V Out

This is a 24V DC output which is activated when the Bell tone or relay only (No MP3 option) is activated. The terminals provided can be used for “Normal” or “Failsafe” modes (see section 2.12 for more details).

5 Network Adapter

This RJ45 port is for connection of a Redback® propriety adaptor board. This allows connection to an ethernet network. The Redback A 4498 Network connection pack is required (see section 3.0 for details).

6 Backup Battery Switch

Use this switch to activate the backup battery. (Note: The backup battery only backs up the current time).

7 Backup Battery

Replace this battery with a 3V CR2032 only. Remove by pulling the battery.
Note: The positive side of the battery faces upward.

8 Lockdown/Fire Volume

Adjust this trimpot to adjust the Alert and Evacuation tones playback volume.

9 Bell Volume

Adjust this trimpot to adjust the Bell playback volume.

10 Music Volume

Adjust this trimpot to adjust the Music playback volume.

11 Voice-over Volume

Adjust this trimpot to adjust the message voice-over playback volume.

12 PreBell Volume

Adjust this trimpot to adjust the PreBell playback volume.

- 13 Audio Out RCA Connectors**
Connect these outputs to the input of the background music amplifier.
- 14 Bell Contact**
These contacts are for remote triggering of the Bell tone. These could be triggered by a remote switch or other closing contact.
- 15 Lockdown Contact**
These contacts are for remote triggering of the Lockdown tone. These could be triggered by a remote switch or other closing contact.
- 16 Fire Contact**
These contacts are for remote triggering of the Fire tone. These could be triggered by a remote switch or other closing contact.
- 17 Cancel Contact**
These contacts are for remote triggering of the cancel function. These could be triggered by a remote switch or other closing contact.
- 18 Mic Volume**
Adjust this trimpot to adjust the Paging Microphone volume (Microphone currently not available).
- 19 RJ45 interface**
This RJ45 port is for connection of a microphone paging console (currently not available).
- 20 RJ45 interface**
This RJ45 port is for connection to the A 4599 or A 4599V wall plates.
- 21 Dip Switches**
These are used to select various options. Refer to DIP Switch Settings section.
- 22 24V DC Input (Backup)**
Connects to a 24V DC backup supply with at least 1 amp current capacity. (Please observe the polarity)
- 23 24V DC input**
Connects to a 24V DC Plugpack with 2.1mm Jack.

2.0 SETUP GUIDE

2.1 INITIAL SETUP

Press the Power/Standby button on the front of the unit. When the unit is in standby mode this switch is illuminated Red. Once pressed the unit will power up and the Blue "On" indicator will illuminate.

Once powered up, the LCD on the front of the unit will illuminate and display the version of firmware installed on the unit. *(Note: Check the redbackaudio.com.au or altronics.com.au websites for the latest Firmware updates. Refer to section 5.0 for help installing firmware updates).*

A series of checks will then be carried out. These include, the confirmation of default audio files required for proper operation and the presence of a correct configuration file.

Out of the box the A 4505D comes supplied with default audio files installed for the Lockdown, Fire, Bell, Prebell, Music and Voice Over functions. If these files are missing or corrupt the unit will not continue. All of this information is stored on the Micro SD card.

Note: If the unit fails to start correctly the Micro SD card may not be inserted correctly or may need to be checked (refer to the Redback Programming Guide).

2.2 LOCKDOWN, FIRE AND BELL SWITCHES

The Lockdown, Fire and Bell switches on the front of the unit all work in momentary mode. ie. The Lockdown tone will continue to sound after the Lockdown switch is momentarily pressed and the Fire tone will continue to sound after the Fire switch is momentarily pressed. There is an automatic Lockdown to Fire switch-over option associated with the front panel switches (refer to section 2.8).

Note 1: The tone that is being sounded (ie Lockdown, Fire, bell) will be indicated by the illumination of the relevant front panel indicator.

Note 2: To cancel a tone either use the remote cancel contacts or the front cancel button. Note the cancel button will need to be depressed for 2 seconds. This is to prevent accidental cancelling of a tone.

The Lockdown, Fire and Bell tones are stored on the supplied SD card. Separate folders are supplied on the SD card for each tone. It is up to the user to provide the MP3 files (they must be in MP3 format) for each of the tones. A library of sample MP3 files is supplied (in the #LIBRARY# folder). See section 2.1 for more details.

NOTE: The unit will display an MP3 error message on the screen if any of the folders on the SD card are left empty. I.e. the Lockdown, Bell, Fire, Music, Prebell and Voice folders must all have an MP3 file inside.

Once these Lockdown, Fire and Bell outputs are activated, the corresponding 24V switched outputs will become active (refer to section 2.6 for more details)

2.3 SETTING THE CURRENT TIME

If the unit starts up correctly and no error messages are displayed, the unit will display the current time on the top line of the LCD and the next event on the bottom line as shown in figure 2.3a.

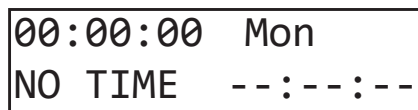

Fig 2.3a

When this screen is displayed the unit is running in "AUTO MODE" and therefore all outputs will work as programmed. However if the unit is in any of the sub menu's (Menu Mode) the unit will no longer respond to any event that has been programmed to occur.

SPECIAL NOTE ABOUT "AUTO MODE" OPERATION

If the timer is not displaying the main clock screen, where the time is changing, the unit is not running in "Auto Mode". This means it will not be checking any of the programmed events and hence will not activate any outputs automatically.

Essentially this means that as soon as the Menu button is pressed the unit is no longer in "Auto Mode". Make sure to return to the main screen by exiting all menu's when not making changes.

Press the “Menu” button on the front of the timer. The unit is now in “Menu Mode” and the screen should display the “Clock Adjust” Screen. This is the first of seven sub menu screens which are navigated by pressing the up and down buttons as shown in Fig 2.3b. Pressing the Menu button again will exit the menu structure and return the user to the Main Screen.

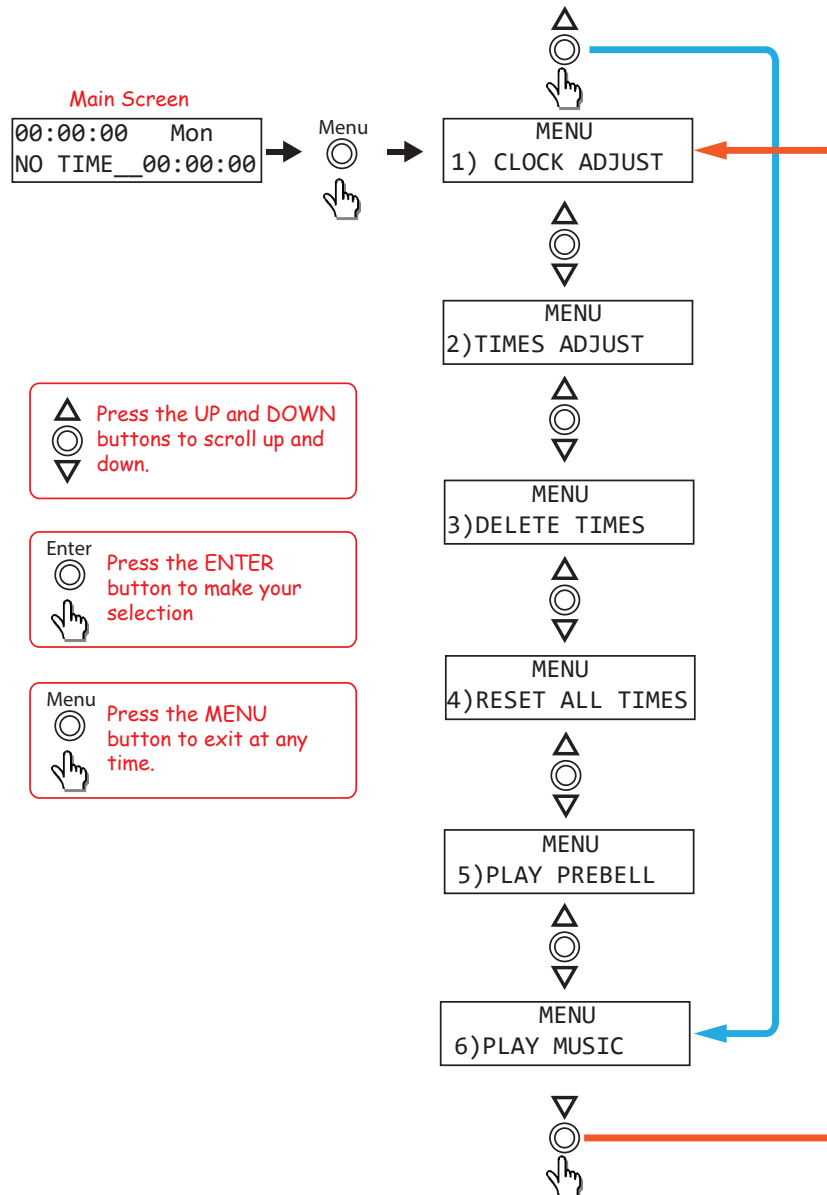

Fig 2.3b

SPECIAL NOTE ABOUT “AUTO MODE” OPERATION

If the timer is not displaying the main clock screen, where the time is changing, the unit is not running in “Auto Mode”. This means it will not be checking any of the programmed events and hence will not activate any outputs automatically.

Essentially this means that as soon as the Menu button is pressed the unit is no longer in “Auto Mode”. Make sure to return to the main screen by exiting all menu’s when not making changes.

Redback® A 4505D Lockdown Timer with Network Access

Select the CLOCK ADJUST sub menu by pressing the “Enter” button.
After selecting this option, the screen as shown in Fig 2.3c should appear.

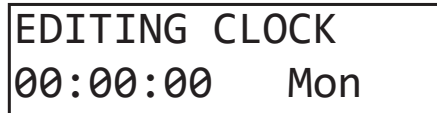

EDITING CLOCK
00:00:00 Mon

Fig 2.3c

The cursor will be positioned over the hour section of the time. Use the up and down buttons to change the hour and then press the “Enter Button” to confirm the hour. The cursor will move to the minutes section of the time. Use the up and down buttons to change the minutes and then repeat the process again for the seconds. Once the seconds have been updated the cursor will move to the day of the week. Use the up and down buttons again to change the day and then press enter to confirm. The time is now set.

2.4 PROGRAMMING THE TIMING EVENTS USING THE SUPPLIED PC SOFTWARE

Refer to the Redback Timer Programming Guide.

2.5 PROGRAMMING THE TIMING EVENTS USING THE FRONT BUTTONS

In order to set up the timing events, the station (or event) times will need to be programmed. This can be achieved by using the buttons on the front of the unit.

Select the “TIMES ADJUST” option from the menu (refer to figure 2.3b). This option allows the user to enter the Station (Event) information which includes the event “Turn on time”, “Period” and “Output”.
After selecting this option, the screen as shown in Fig 2.5a should appear.

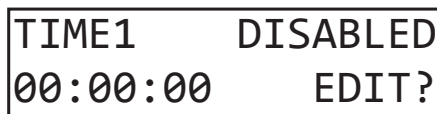

TIME1 DISABLED
00:00:00 EDIT?

Fig 2.5a

The top left text is the time event number. Up to 50 events can be programmed into the A 4505D. Pressing the “up” and “down” buttons at this stage will move up and down through the events 1- 50. The top right text indicates that TIME1 (Event1) is currently disabled. The bottom left text refers to the time this event will happen (i.e. the “Start” Time).
Press the “Enter” button to edit this event, or press the “Menu” button to exit.
Pressing the Enter button will take you to the “Editing Time” screen (Refer to fig 2.5b). This is where the event “Start” time is entered.

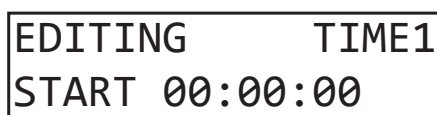

EDITING TIME1
START 00:00:00

Fig 2.5b

The cursor will be positioned over the hour section of the time. Use the up and down buttons to change the hour and then press the “Enter Button” to confirm the hour. The cursor will move to the minutes section of the time. Use the up and down buttons to change the minutes and then repeat the process again for the seconds. Once the seconds have been updated the screen will change to the “Period” set screen (Refer to fig 2.5c) . This is where the duration of the event is recorded.

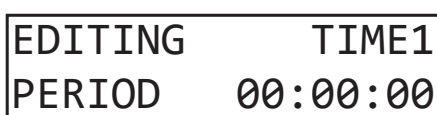

EDITING TIME1
PERIOD 00:00:00

Fig 2.5c

Once again, use the up and down buttons to set the hour, minutes and seconds and press enter when finished. Once the period has been set, the desired output for this event is to be set using the "Output" screen (See fig 2.5d).

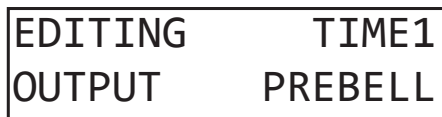

Fig 2.5d

The output defaults to Disabled. Scroll through the other options by using the up and down buttons. The Output can be set to Prebell, Bell, Music, No MP3/Relay Only or outputs 5-99. These outputs correspond to the audio files located on the Micro SD card which are configured by the Timer Programming Software.

(Note: Direct MP3 file manipulation on the Micro SD card is no longer available).

Once the desired output for the event has been set, press the enter button to move to the next screen (See fig 2.5e).



Fig 2.5e

This is where the days of the week this event will occur are entered. The top right line of text refers to the days of the week, Monday through to Sunday. The line of text below this sets each day "ON" or "OFF". Use the up and down buttons to set the day to Y for "ON" and N for "OFF".

Once the days of the week are set, press the enter button to confirm and be returned to the main menu. Repeat this process for any other events to be programmed.

This process of entering the events can be quite time consuming so it is recommended using the PC software (Redback Weekly Timer Programmer.exe).

2.6 DELETING A PROGRAMMED TIME

Select the "DELETE TIMES" option from the menu (refer to figure 2.3b).

After selecting this option, the screen as shown in Fig 2.6 should appear.

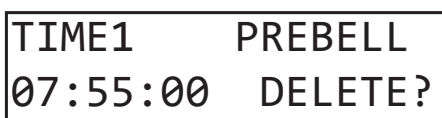

Fig 2.6

From this point the "Up" and "Down" buttons can be used to scroll through the different times, or press the "Enter" button to delete this time. After deleting the time, a message will indicate that the time has been cleared and the next time will then be displayed on the screen. Press "Enter" to delete, "Menu" to exit or the "Up" and "Down" buttons to scroll to another time.

2.7 RESET ALL PROGRAMMED TIMES

Select the "RESET ALL TIMES" option from the menu (refer to figure 2.3b).

After selecting this option, the screen as shown in Fig 2.7 should appear.

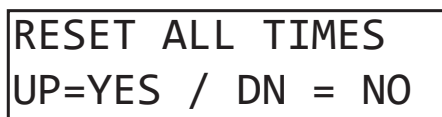

Fig 2.7

Redback® A 4505D Lockdown Timer with Network Access

Press the “UP” button to reset all the times programmed and stored on the Micro SD card. Press the “No” button to exit without resetting the times.

2.8 EV CHANGEOVER

Select the “EV CHANGEOVER” option from the menu (refer to figure 2.3b).

After selecting this option, the screen as shown in Fig 2.8 should appear.



Fig 2.8

This option allows the user to enter the automatic switch over time between the Alert and Evac cycles.

NOTE: This affects the front panel Alert and Evac buttons and the rear Alert and Evac contacts.

Press the “UP” and “DOWN” buttons to scroll through the various times available and press enter when the desired switch-over time is highlighted. The changeover times go in 10 second intervals up to 600 seconds.

NOTE: If the changeover time is set to “0” the changeover will be de-activated and therefore the unit will not switch over from the Alert cycle to the Evac cycle automatically.

2.9 PLAY PREBELL

Select the “PLAY PREBELL” option from the menu (refer to figure 2.3b).

After selecting this option, the screen as shown in Fig 2.9 should appear.

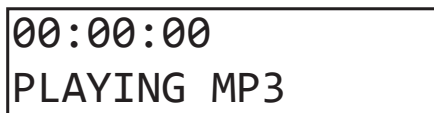

Fig 2.9

The Audio File associated with the “Pre bell” output will sound. Press the cancel button on the front of the unit to cancel.

2.10 PLAY MUSIC

Select the “PLAY MUSIC” option from the menu (refer to figure 2.3b).

After selecting this option, the screen as shown in Fig 2.10 should appear.

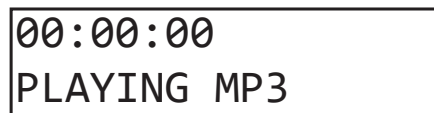

Fig 2.10

The Audio File associated with the “Music” output will sound. Press the cancel button on the front of the unit to cancel.

2.11 AUDIO CONNECTIONS

Audio Output:

This output consists of stereo RCA sockets with an output of 0dBm into a 600Ω input. This is suitable for most PA amplifier auxiliary inputs.

Rear Panel Volume Controls:

The output levels of the Lockdown/Fire, Prebell, Bell, Music and Voice Over tones can all be adjusted via trimpots located on the rear of the unit.

2.12 DIP SWITCH SETTINGS

The A 4505D has various options which are set by the DIP switches on the rear of the unit. These are outlined below and in figure 2.11.

IMPORTANT NOTE:
Ensure power is switched off when adjusting DIP switches.
New settings will be effective when power is switched back on.

Switch 1

This switch is used to either loop the Bell/Prebell, or play the Bell/Prebell only once after it has been triggered.
 ON = Loop, OFF = Play Once

Switch 2

DIP switch 2 enables or disables the voice over message. The voice-over message is played in between every three cycles of the Fire tone.

ON = Enabled, OFF = Disabled

Switch 3

This switch can be used to lockout the menu button, to deter tampering with the programmed times.

ON = Menu button disabled, OFF = Menu button enabled

Switch 4

This switch can be used to lockout the front isolate button.

ON = Isolate button disabled, OFF = Isolate button enabled

Switch 5-8 Not Used

DIP SWITCH SETTINGS					
SW	ON	OFF	SW	ON	OFF
1	Loop PreBell/Bell Until Cancelled	Play Prebell/Bell Once	2	Voice Over Enabled	Voice Over Disabled
3	Disable Menu Options	Enable Menu Options	4	Disable Isolate Switch	Enable Isolate Switch
5-8	NOT USED				

Fig 2.11

2.13 24V OUTPUT CONNECTIONS

These contacts can be used for connection of override relays in remote volume controls, or strobes for unusually noisy environments. An override relay is necessary where attenuators are used so that the Lockdown tone, Fire tone or message is broadcast at full volume regardless of the volume setting on the individual volume control (attenuator).

Lockdown/Fire 24V Out:

These contacts are for switched 24V outputs whenever the Lockdown or Fire tones are activated. These may be used to run external systems such as strobes in unusually noisy environments, or override relays in remote volume controls.

When this output becomes active, 24V will appear between the N/O contact and the GND contact. When this output is not active 24V will appear between the N/C contact and the GND.

Bell 24V Out:

These contacts are for switched 24V outputs whenever the Bell or Relay Only (No MP3 option) are activated. These contacts are for operating an external relay used to operate something like a lunch bell etc.

When this output becomes active, 24V will appear between the N/O contact and the GND contact. When this output is not active 24V will appear between the N/C contact and the GND.

Common 24V Out:

These contacts are for switched 24V outputs whenever the Lockdown, Fire, Bell, Prebell or Relay Only (No MP3 option) tones are activated. When this output becomes active, 24V will appear between the N/O contact and the GND contact. When this output is not active 24V will appear between the N/C contact and the GND.

Redback® A 4505D Lockdown Timer with Network Access

3.0 NETWORK ACCESS

The Redback® A 4505D has been upgraded from previous versions to now include access via a network connection. The unit is connected with the addition of the Redback® A 4498 Network Connection Pack. With the upgraded PC software all the event timing and audio file selection can be adjusted remotely.

Note: Audio files cannot be transferred via this connection. All audio files must be loaded onto the supplied Micro SD card via the PC software. These files are stored in a Library on the SD card and can then be selected remotely.

Figure 3.1 below demonstrates how to connect the timer to a network via the Redback® A 4498 Connection Pack. The pack includes a serial to ethernet converter, a propriety adaptor board, a DC power lead and a short CAT6 lead for connection between the A 4505D and the Adaptor board. The Serial to Ethernet Converter requires some configuration which is outlined in the A 4498 instruction manual.

Once the Serial To Ethernet Converter setup is complete and all required connections made, the unit should now be accessible via the PC software. Refer to the supplied Software Programming Guide for more information.

Note: An IT administrator or someone experienced with network protocols will be required to setup the network access.

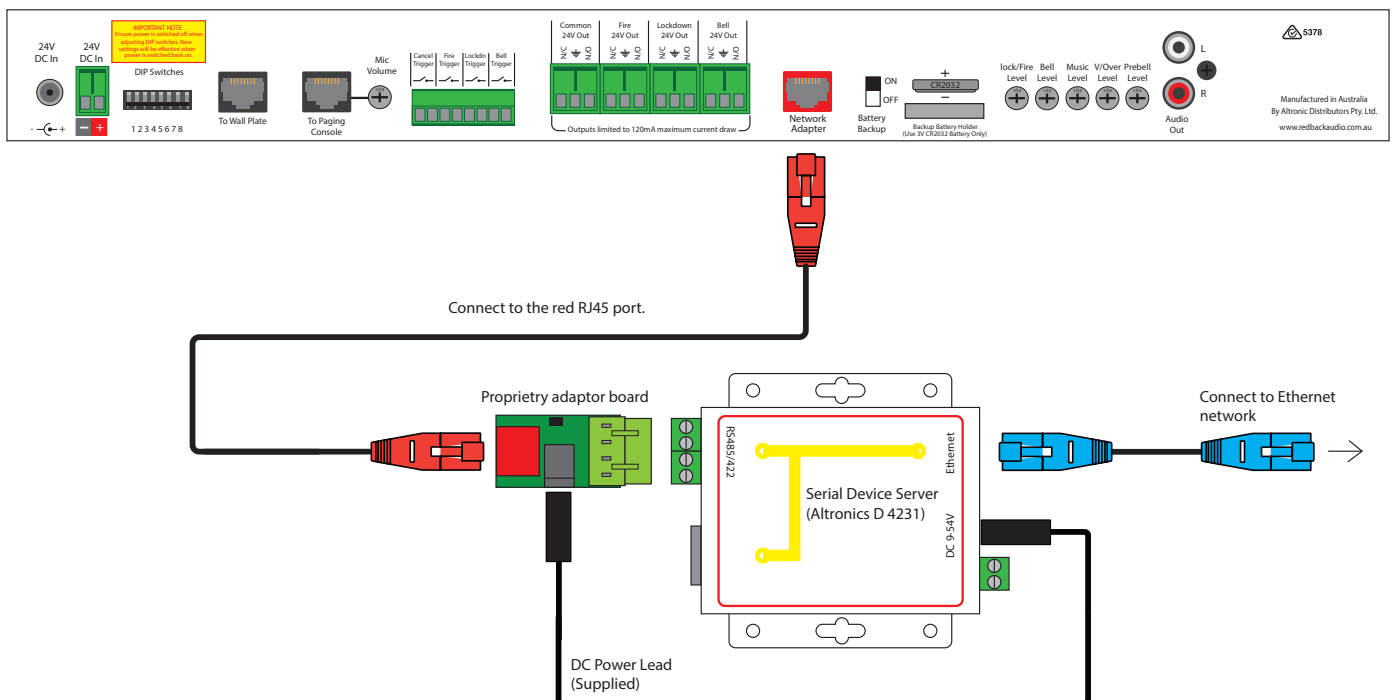
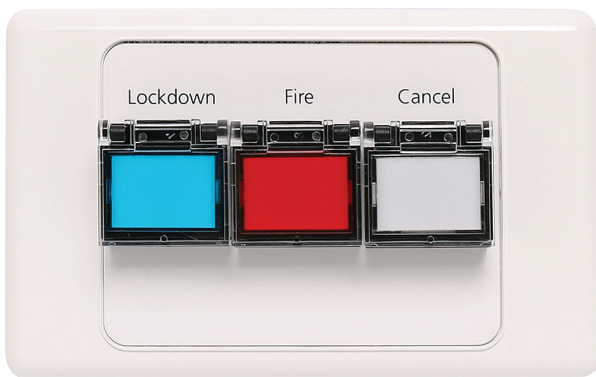

Fig 3.1 Connecting the timer to a network via the Redback® A 4498 Connection Pack

4.0 REMOTE WALL PLATES

There are a number of wall plates which can be connected to the A 4505D for remote triggering of the Lockdown, Fire and Bell tones and for remotely cancelling any tones which may be active.

4.1 A 2064 and A 2069 Remote Plates



A 2064

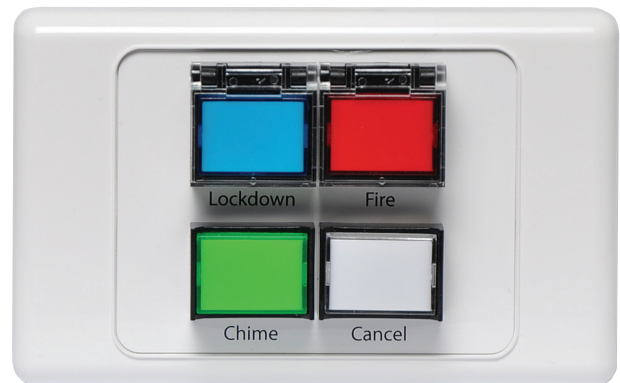

A 2069

The Redback® A 2064 wall plate provides a remote means of triggering the Lockdown, Fire and cancel functions of the Redback® A 4505D. Connection from the A 2064 is made to the A 4505D via a minimum of 6 wires as shown in Fig 4.1.

The Redback® A 2069 wall plate provides a remote means of triggering the Lockdown, Fire, Bell and cancel functions of the Redback® A 4505D. Connection is made from the A 2069 to the A 4505D via a minimum of 8 wires as shown in Fig 4.2.

If standard Cat5/6 cable is used for the wiring, the plates can be located up to 30m away from the main unit.

(Note: The A 2064 and A 2069 plates uses screw terminal connections). This can be increased to 100m using heavier gauge cable, which reduces the voltage drop across this distance and ensures the switch leds illuminate.

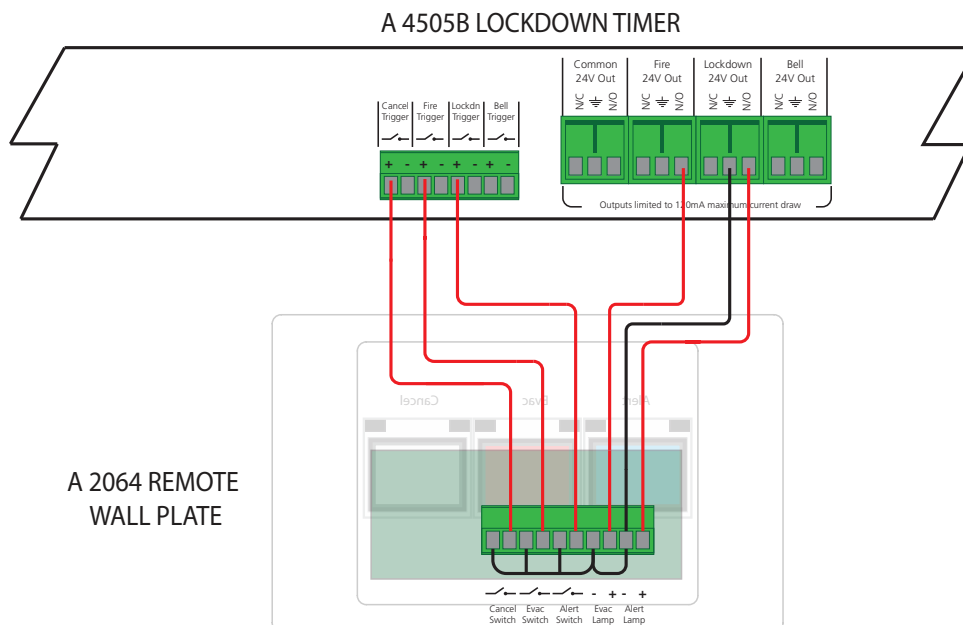

Fig 4.1 Hard wired connection between the A 2064 and A 4505D

Redback® A 4505D Lockdown Timer with Network Access

The Lockdown/Fire/Cancel switches on the Redback® A 2064 wall plate are connected to the corresponding contacts on the rear of the Redback® A 4505D. While the Lockdown and Fire LED's on the wall plate are connected to the Lockdown and Fire 24V outputs of the Redback® A 4505D.

A minimum of six wires can be used on the A 2064 if the ground connections of the Lockdown and Fire 24V outputs and the Lockdown/Fire and cancel switch grounds are linked together (see Fig 4.2).

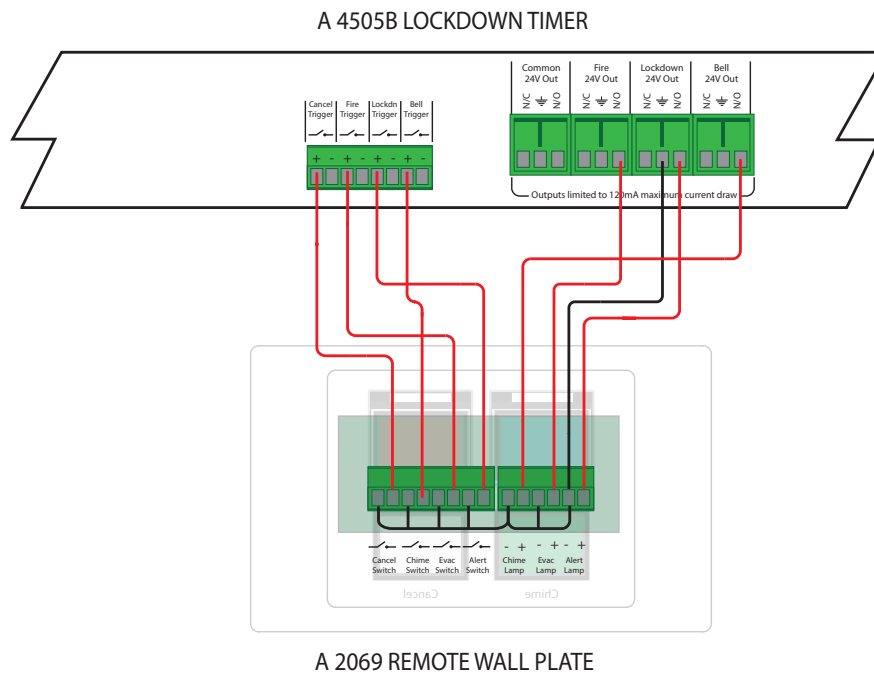

Fig 4.2 Hard wired connection between the A 2069 and A 4505D

The Lockdown/Fire/Chime/Cancel switches on the Redback® A 2069 wall plate are connected to the corresponding contacts on the rear of the Redback® A 4505D. While the Lockdown, Fire and Bell LED's on the wall plate are connected to the Lockdown, Fire and Bell 24V outputs of the Redback® A 4505D.

The cancel LED is not connected.

A minimum of eight wires can be used if the ground connections of the Lockdown, Fire and Bell 24V outputs are linked with the Lockdown, Fire, Chime and Cancel switch grounds (see Fig 4.2).

4.2 A 4599 and A 4599V Remote Plates

The Redback® A 4599 and A 4599V wall plates allow a remote means of triggering the Lockdown, Fire and Bell tones and the cancel function. The switches are momentary operation and must be pressed for up to 3 seconds to activate. The switches have protective “flip up” covers to prevent accidental operation.



Fig 4.3 A 4599



Fig 4.4 A 4599V

Connection is made to the Redback® A 4505D via standard Cat5e cabling as shown in Fig 4.5. There are two RJ45 ports on the rear of the wall plate, either of which can be used.

Only one Redback® A 4599 or A 4599V wall plate is allowed to be connected to the Redback® A 4505D via the RJ45 port.

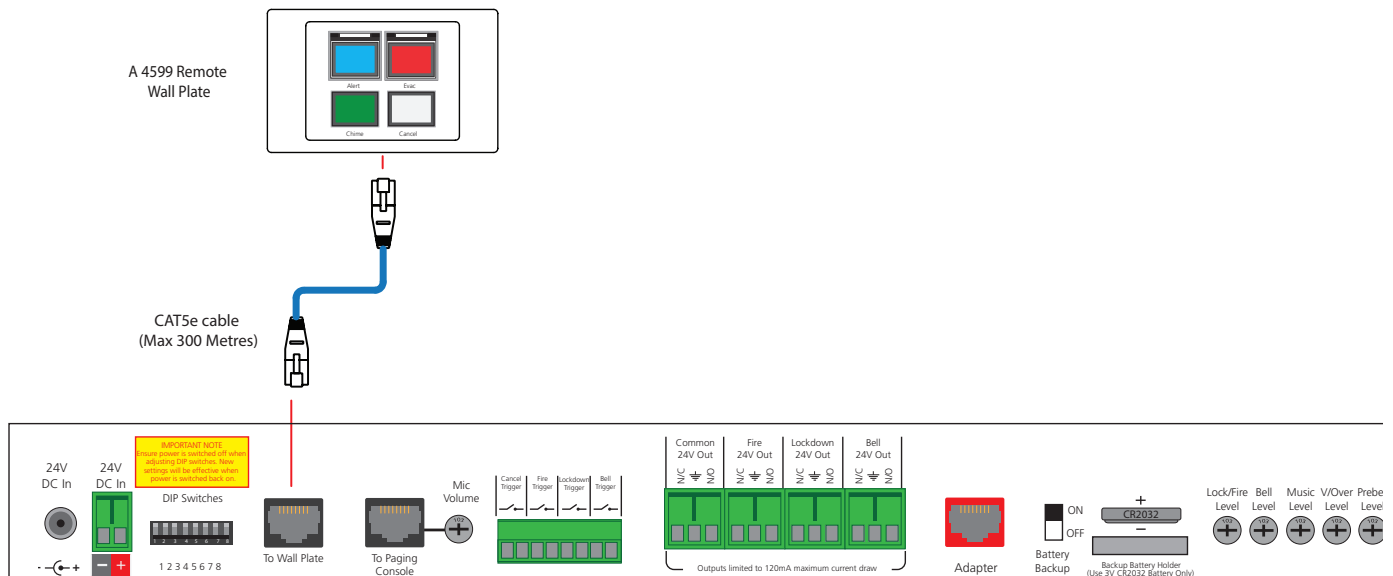

Fig 4.5 Connection of (One only) wall plate via CAT5/6 cabling.

5.0 A 4660A PAGING CONSOLE

5.1 A 4660A OVERVIEW

The A 4660A paging console provides general paging, emergency paging and remote selection of "Alert", "Evac", "Bell" and "Cancel" modes.

General paging is achieved by simply pressing the PTT (push to talk) switch and then speaking. General paging will override the Bell function.

Emergency paging is available when the unit is in an emergency mode i.e. In Alert or Evac Mode.

If one of these modes is active, emergency paging is achieved by pressing the paging button.

When activated, emergency paging overrides all functions of the A 4505D.

A maximum of 1 paging console can be connected to the A 4505D. The console is wired back to the A 4505D via Cat5e/6 cabling to the RJ45 port on the rear of the unit (see section 5.3 for details).

Note: For long cable runs Redback® A 4658 power injectors may be required.

Each unit must be assigned an address which is set when the A 4660A is first initialised, or it can be re-assigned by accessing the Factory Reset option (see page 19). The address when connecting to the A 4505D can be any number from 1-8.

The Alert, Evac and Bell modes can be activated from the A 4660A paging console. Simply Press the button for the desired mode and hold for 2-3 seconds to activate.

Note: These modes are inactive when the A 4505D is in manual or isolate mode.



5.2 A 4660A SETTINGS MENU

The settings menu can be accessed using the icon on the top left of the screen. Once in this menu the following screen will be displayed, which shows the various settings available.

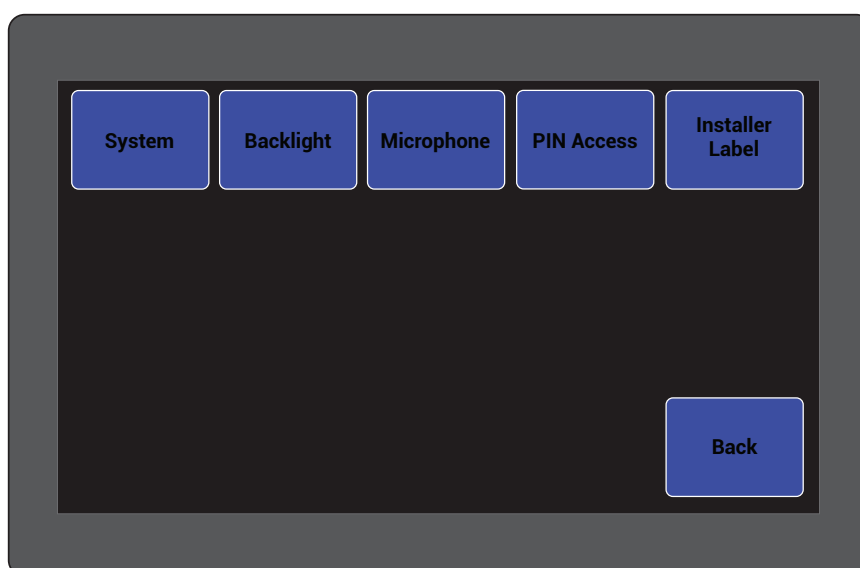

Fig 5.1 - Console Settings Screen.

5.2.1 System Settings

The System settings screen is shown in figure 5.2.

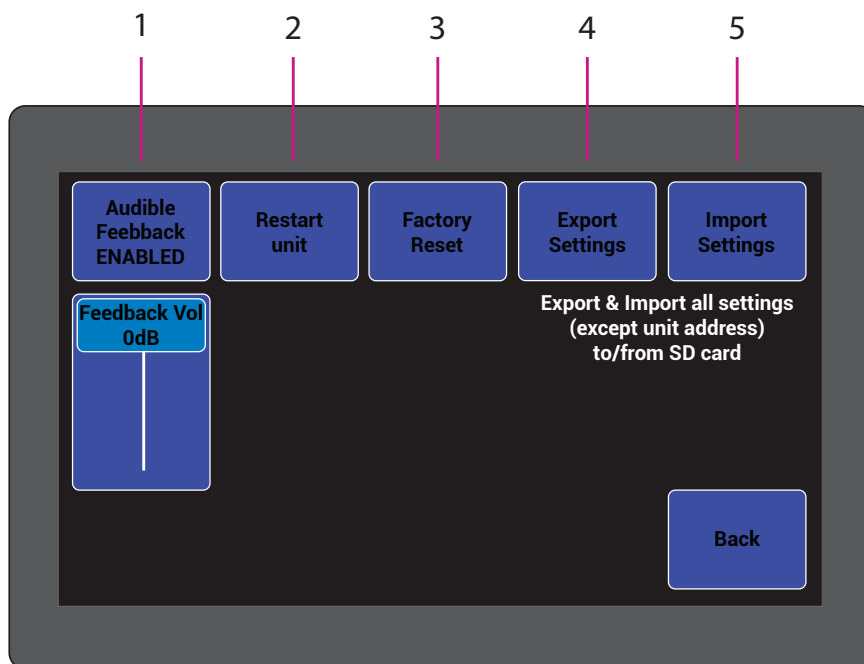

Fig 5.2 - System Settings Screen.

- 1 Audible Feedback** - Allows you to enable/disable the audible feedback (in built speaker) on button presses and set the volume. Press the button to enable/disable and use the slider below to adjust the feedback volume.
- 2 Restart unit** - This will cycle power to the A 4505D and re-start the unit. Handy if the unit is locked away.
- 3 Factory reset** - This will reset the unit back to it's default settings. This option is also required to re-assign the paging console address (Press the factory reset button, tap confirm and a prompt will appear for the units address. Select the required address (which can be any number from 1-8). If any settings need saving before the factory reset, use the Export Settings option below.
- 4 Export Settings** - This feature allows the settings of the unit to be transferred to another unit or kept as a back up. Simply insert a Micro Sd card into the unit and follow the prompts.
- 5 Import Settings** - This feature allows the settings of the unit to be imported from another unit. Insert a Micro SD card and follow the prompts.

5.2.2 Backlight Settings

Press the "backlight" button to display the screen shown in figure 5.3.

There are two levels of screen brightness which come into effect, when the screen hasn't been touched for a period of time set by the user.

This menu screen allows the user to select the active screen brightness level, the dimmed brightness level and timeout periods for the transition from active screen mode to dimmed mode, and the transition period from dimmed mode to screen off mode.

- 1 Active Screen Brightness Level** - Use this slider to adjust the brightness level of the active screen.
- 2 Dimmed Screen Brightness Level** - Use this slider to adjust the brightness level of the dimmed screen
- 3 Active Screen to Dimmed Mode transition time** - Use these buttons to adjust the timeout period to enter dimming mode (set to 0 for the screen to be remain always on).
- 4 Dimmed Mode to screen Off transition time** - Use these buttons to adjust the timeout period from dimmed screen mode to the screen turning off completely (This is unavailable if the dimming mode is set to zero).

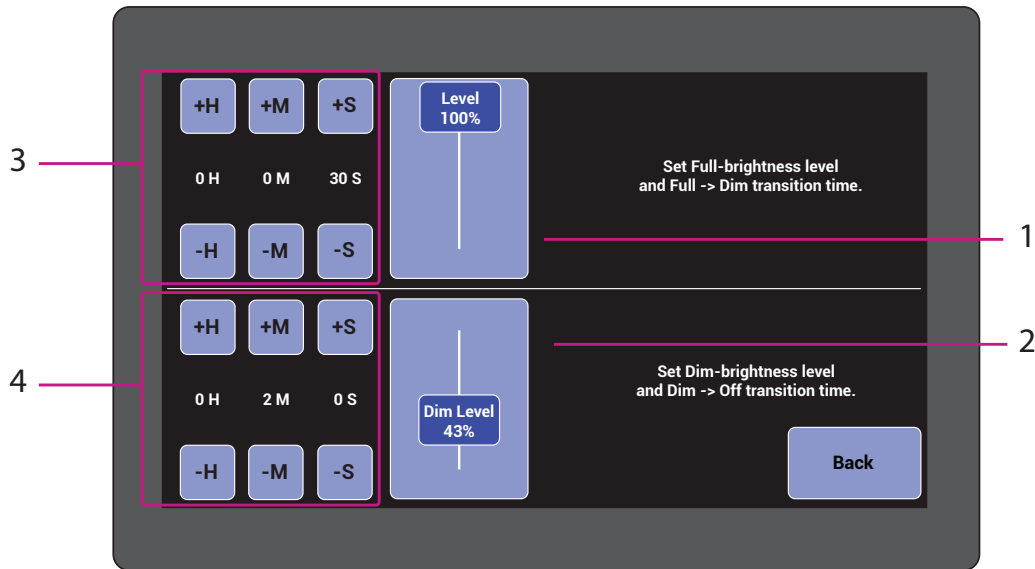

Fig 5.3 - Backlight Settings Screen.

5.2.3 PIN Access - Set an optional access PIN preventing unauthorised access to the wallplates settings. Type in a preferred PIN and press “E” to accept. Press “C” to delete PIN digits or to reset the PIN (For access without a PIN, delete all PIN digits). Once complete press the BACK button and the change will take effect.

5.2.4 Installer label - Allows you to customise an installer label which is displayed on the top of the main screen. Use the displayed keyboard to enter the label and press enter.

5.2.5 Microphone settings

Press the “microphone” button to display the screen shown in figure 5.4. From this menu the chime options and action of the paging button are set.

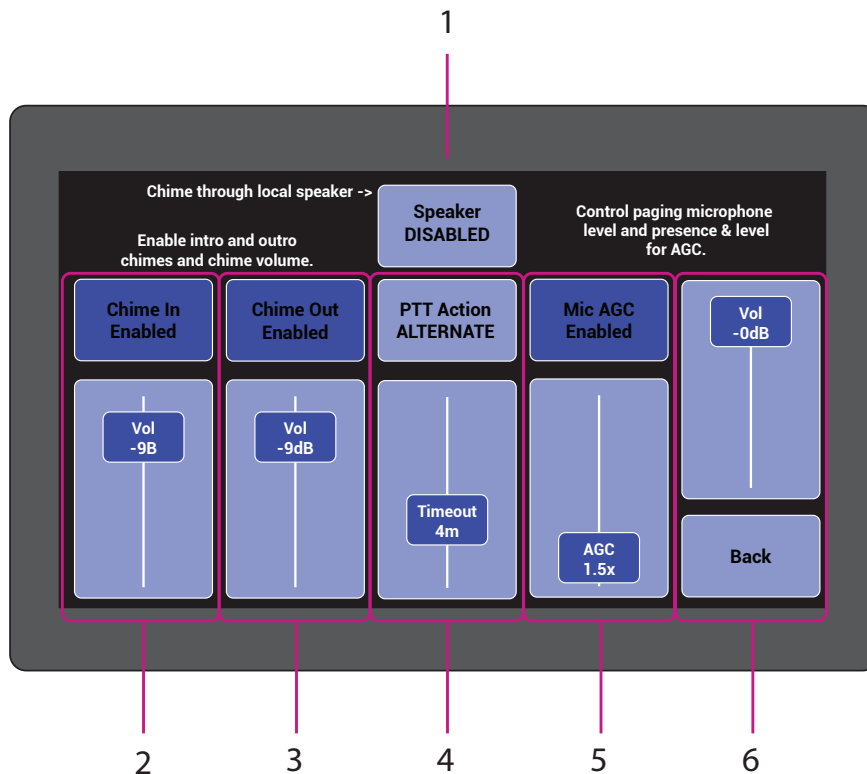

Fig 5.4 - Microphone Settings Screen.

1 Console Speaker - This button enables the speaker built into the A 4660A. audible from the console as well as through the paging system.

If enabled the chime will be

- 2 **Chime In** - This button allows you to enable or disable the pre-announcement chime on the paging audio. The level can also be adjusted to suit the installation. For instance a user may require the pre-announcement chime be louder than the normal programming.
- 3 **Chime Out** - This button allows you to enable or disable the post-announcement chime on the paging audio. The level can also be adjusted to suit the installation. For instance a user may require the post-announcement chime be louder than the normal programming.
- 3 **PTT Action** - This button determines the action of the paging button. If momentary action is selected the paging button will need to be held to page. If alternate action is selected the paging button needs to be pressed and released to start paging. The paging mode will stay active for the period set by the timeout, or until the paging is cancelled by the user.
- 5 **Mic AGC** - Allows for the microphones automatic gain control (AGC) effect to be adjusted up or down according to installation requirements. AGC allows the signal to automatically adjust to compensate for variations in level of peoples voices when making paging announcements. Please note high levels of AGC will increase audible noise in the system while paging.
- 6 **Paging Level** - Adjust the paging level to suit the installation. This allows for paging to be adjusted to suit the level of programming from other sources connected to the system.

5.3 Connecting the paging console

The console is connected to the A 4505D via standard Cat5e/6 cabling as shown in figure 5.5.

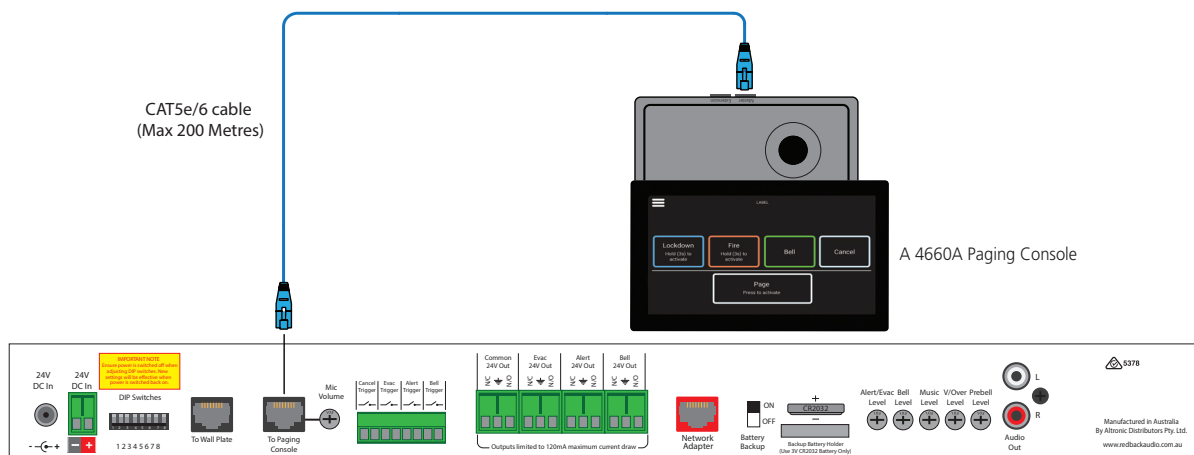

Fig 5.5

There is one RJ45 port on the back of the A 4505D which can be used to connect a single A 4660A paging console. The maximum distance between the A 4505D and a paging console is 200m.

Note: External power injectors (Redback ® A 4658) may be required if power problems are encountered from long cable runs. This is shown connected to the console in the example of figure 5.6.

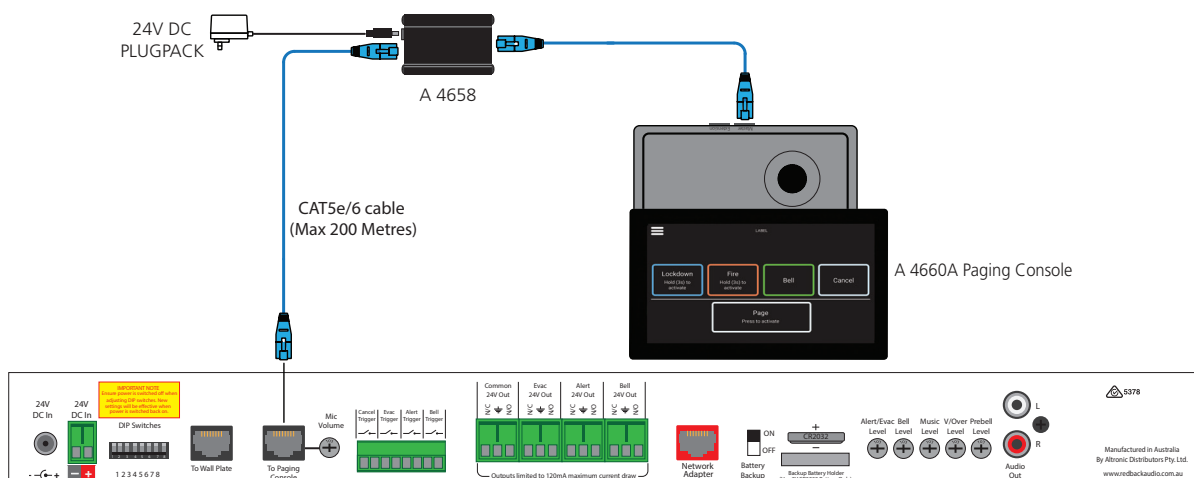

Fig 5.6

Note: Power Over Ethernet or POE's cannot be used as the power injectors as they run on 48V. The A 4505D and A 4660A systems are powered by 24V DC. Use of POE's will void the warranty.

6.0 TROUBLE SHOOTING

6.1 SYMPTOMS AND REMEDIES

SYMPTOMS

PC SOFTWARE WILL NOT RUN

ERROR1 (SD card not found)
ERROR2 (SD card not formatted properly)
ERROR4 (Cannot find an MP3 to play)
ERROR7 (Cannot Play MP3)

ERROR (FAT format)

ERROR8 (Fault with Configuration File)

Power switch is illuminated Red but unit doesn't work

Unit will not play MP3 files.

Unit doesn't play an MP3 at the appointed time.

Alarm times have been updated by user but the times don't change.

Wall plate or paging console doesn't operate after being connected.

REMEDIES

The PC software for this product may not run on all PC's. The .NET framework on the PC has to be updated to .NET Framework 4. Available for download on the microsoft website.

CHECK SD CARD HAS BEEN INSERTED CORRECTLY
CHECK SD FORMATTED CORRECTLY
CHECK MP3 FILES INSTALLED
CHECK FORMAT OF MP3 (It cannot be WAV or AAC)
MP3 files cannot be "Read Only" See page 9.

Note 1: MP3 files should have the following specifications for optimum performance. 128kbps, 44.1kHz, 32bit, VBR or CBR, Stereo (even better as mono).

MICRO SD CARD must be a maximum of 64GB Max SDHC, and formatted to FAT32

CHECK CONFIGURATION FILE (Incorrect time??)

The unit is in standby mode. Press the Power/Standby switch. The unit is ON when the Blue ON LED is illuminated.

Make sure all MP3 files are not "Read Only". See page 9.

This could be caused by MP3 files which are Read Only. The unit will attempt to play the file but not be able to play it, hence the MP3 will not be played at the appointed time.

The times are saved to a file named "config.cnf". This file cannot be named anything else. It must also be saved to the root folder of the SD card.

Turn the timer OFF and then back ON again.

6.2 RJ45 cabling configuration for system components (568A 'Straight through')

System components are connected using "pin to pin" configuration RJ45 data cabling as shown in fig 6.1. When installing ensure all connections are verified with a LAN cable tester before switching any system component on.

Failure to follow the correct wiring configuration may result in damage to system components.

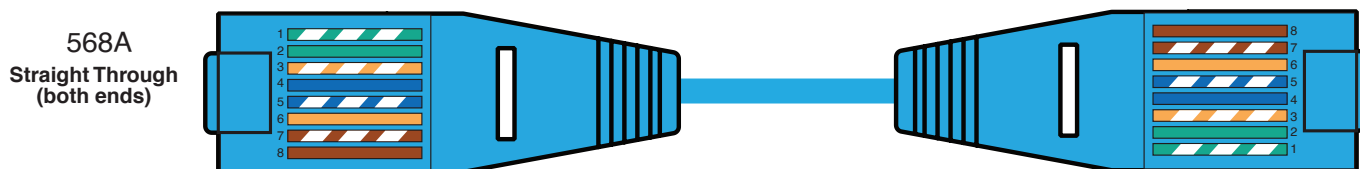

Fig 6.1

WARNING

System components are connected using standard "pin to pin" configuration RJ45 data cabling. When installing ensure all connections are verified before switching any system component on.

Failure to follow the correct wiring configuration may result in damage to system components.

7.0 FIRMWARE UPDATE

It is possible to update the firmware for this unit by downloading updated versions from www.altronics.com.au or redbackaudio.com.au.

To perform an update, follow these steps.

- 1) Download the Zip file from the website.
- 2) Remove the SD card from the A 4505D and insert it into your PC. (Follow the steps on page 8 to open the SD card).
- 3) Extract the contents of the Zip file to the root folder of the SD Card.
- 4) Rename the extracted .BIN file to update.BIN.
- 5) Remove the SD card from the PC following windows safe card removal procedures.
- 6) With the power lead removed from the rear of the unit, insert the Micro SD card back into the A 4505D.
- 7) Reconnect power to the A 4505D and turn ON. The unit will check the Micro SD card and if an update is required the A 4505D will perform the update automatically.

Redback® A 4505D Lockdown Timer with Network Access

8.0 SPECIFICATIONS

OUTPUT LEVEL:.....0dBm
DISTORTION:.....0.01%
FREQ. RESPONSE:.....140Hz - 20kHz
SIGNAL TO NOISE RATIO:
Lockdown/Fire/Chime:.....-70dB typically

OUTPUT CONNECTORS:

Audio Output:.....RCA Stereo Socket
Common 24V DC Out:.....Screw Terminals
Lockdown 24V DC Out :... Screw Terminals
Fire 24V DC Out:.....Screw Terminals
Bell 24V DC Out:.....Screw Terminals

PLEASE NOTE:

Output loads limited 0.12Amp each

INPUT CONNECTORS:

24V DC Power:.....Screw Terminals
24V DC Power:.....2.1mm DC Jack
Remote Lockdown, Fire, Bell, Cancel:
.....Screw Terminals

WALLPLATE/PAGING CONSOLE INPUTS:.. RJ45 8P8C
DATA TRANSMISSION:.....Cat5e cabling max 300m

CONTROLS:

Lockdown/Fire:.....Rear Volume
Voice over:.....Rear Volume
Bell:.....Rear Volume
Prebell:.....Rear Volume
Music:.....Rear Volume

Power:.....On/Off Switch
Lockdown Switch:..Illuminated Push Switch
Fire Switch:.....Illuminated Push Switch
Bell Switch:.....Illuminated Push Switch
Cancel Switch:.....Push Switch

INDICATORS:.....Power on, MP3 error, Prebell

MICRO SD CARD: 64GB Max SDHC, FAT32

MP3 FILE FORMAT:128kbps, 44.1kHz, 32bit,
VBR or CBR, Stereo (even better as mono).

POWER SUPPLY:..... 24V DC

DIMENSIONS:~..... 482W x 175D x 44H

WEIGHT: ~..... 2.1 kg

COLOUR:Black

* Specifications subject to change without notice

All Australian made Redback products are covered by a 10 year warranty.

Should a product become faulty please contact us to obtain a return authorisation number. Please ensure you have all the relevant documentation on hand. We do not accept unauthorised returns. Proof of purchase is required so please retain your invoice.