

KTY-THP10-ZG

SKU: KGW00003



KONEC WIRED-ZIGBEE SMART GATEWAY







INSTALLATION GUIDE

Scan the QR Code to download Arks by Konec Solutions App



Disclaimer	Installation Safety Warnings
<ul style="list-style-type: none"> This guide is intended to assist qualified professionals with the correct installation of the Konec Wired-Zigbee Smart Gateway. Please follow all instructions carefully and ensure compliance with AS/NZS 3000 and local regulations. Improper installation or modification may void the warranty and result in safety risks. This guide is for reference only. Product details may change without notice. To the extent allowed by law, Konec Solutions is not liable for any damage, injury, or loss resulting from the use of this guide or the installation process. This disclaimer does not affect your rights under the Australian Consumer Law or the New Zealand Consumer Guarantees Act 1993. 	<p>To ensure a safe and compliant installation, please follow these precautions:</p> <ul style="list-style-type: none"> This product is designed for professional installation. Installation must comply with AS/NZS 3000 and all relevant local electrical and building regulations. Do not exceed the product's rated electrical capacity. Avoid using power tools unless explicitly specified. Do not install in areas exposed to water or high humidity unless rated for such conditions. Use appropriate personal protective equipment (e.g., gloves, safety glasses).

WHAT'S INCLUDED

<p>SMART GATEWAY * 1</p> 	<p>ADAPTOR * 1</p> 
<p>POWER CABLE * 1</p> 	<p>ETHERNET CABLE * 1</p> 
<p>IN-BOX USER MANUAL * 1</p> 	<p>OPTIONAL ADD-ON: WALL MOUNT</p>  <p>Disclaimer: This optional accessory is special order only. For pricing and availability, contact the Konec Solutions team.</p>

INSTALLATION

- Choose an appropriate location to set up the gateway.
- Connect the power supply and power cable to the Type-C port.
- Connect the Ethernet Cable from the LAN port to the network jack.

Input Voltage Requirement: DC 5V/1A

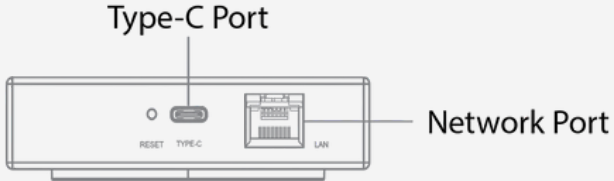

Placement Consideration: Place on a shelf mount, rather than on the floor with minimal interference.

Disclaimer: The installation environment requirements and signal transmission distance guidelines for suitable installation locations can be found in the specifications table.

NEXT STEPS

The Konec Wired-Zigbee Smart Gateway Installation Guide has been completed.

For Set Up and Configuration steps, go to the official Konec website for more information. Go to the product page's resource section and refer to:



USER MANUAL - Konec Wired-Zigbee Smart Gateway

Model Name: KTY-THP10-ZG

SKU: KGW00003



Note: Be sure to consult the appropriate user manual, as various versions may differ in their configuration, setup, and functionality. The latest version of the document will be available on the official Konec Solutions website.

Note: If you cannot find the suitable Konec Wired-Zigbee Smart Gateway User manual on the website, please contact the Konec Solutions Representative for further information.

Konec Solutions Pty Ltd

Please do not hesitate to contact us if you have any questions.



Konec Official Web

<http://www.konechome.com.au>



Hotline

1300 2 56632 (1300 2 KONEC)



Sales & Partnership

sales@konec.com.au



Customer Support

support@konec.com.au



Address

L3 5 Talavera Road Macquarie Park NSW 2113