

KONEC SMART OUTLET WITH ENERGY MONITORING

USER MANUAL

**For all Konec Smart Outlet with
Energy Monitoring Series**

CONTENTS

1. Notice	
Disclaimers.....	01
Important Safety Instructions.....	01
2. Product Overview	
Product Description.....	02
Voice Assistant.....	02
Features.....	02
Certification.....	02
Variations.....	03
Dimensions.....	03
Exploded View.....	04
Specifications.....	05
3. Set Up	
What's Included.....	06
Wiring Diagram.....	06
Cut-out Requirements.....	07
Installation.....	08
4. Configuration Guide	
Download the App.....	09
Add product to Arks.....	09
Device Control Page.....	11
Remove from Arks.....	20
5. Scene	21
6. Indicator Light Status	28
7. Contact Us	29

1. NOTICE

DISCLAIMERS

- This User Manual is designed to help you get the most out of your Konec Smart Outlet with Energy Monitoring. Please read it carefully before use. For your safety and the best experience, we recommend that installation and maintenance be carried out by a qualified professional.
- The information provided in this manual is for general guidance and reference purposes only. Konec Solutions Pty Ltd makes no representations or warranties, express or implied, regarding the completeness, accuracy, or suitability of the content. Product specifications, features, and visuals are subject to change without notice .
- This product must be installed, repaired, and maintained in accordance with AS/NZS 3000 and applicable local laws . Improper installation, use, or unauthorised modification may void the warranty and pose safety risks.
- To the extent permitted by law, Konec Solutions disclaims any liability for direct, indirect, incidental, or consequential damages arising from the use of this manual or the product itself.
- This disclaimer does not affect your rights under the Australian Consumer Law or the New Zealand Consumer Guarantees Act 1993 .
- All content in this document—including text, images, and graphics—is the property of Konec Solutions. No part may be reproduced, translated, or modified without prior written permission.
- For the latest version of this manual, please visit www.konechome.com.au.

IMPORTANT SAFETY INSTRUCTIONS

To ensure a safe and compliant installation, please follow these precautions:

- This product is designed for professional installation.
- Disconnect power before starting installation or maintenance.
- Installation must comply with AS/NZS 3000 and all relevant local electrical and building regulations.
- Do not exceed the product's rated electrical capacity.
- Avoid using power tools unless explicitly specified.
- Do not install in areas exposed to water or high humidity unless rated for such conditions.
- Use appropriate personal protective equipment (e.g., gloves, safety glasses).

For product usage and maintenance safety, please refer to the User Manual.

2. PRODUCT OVERVIEW

PRODUCT DESCRIPTION

The smart single power socket includes a Floating button and a Type-C port.

This product's design aligns with the NDIS Specialist Disability Accommodation Design Standard.

*This outlet requires the Konec Zigbee hub to enable smart features like remote control and energy monitoring.



FEATURES



MANUAL CONTROL

Manually turn on/off the outlet with a physical button that complies with the NDIS standards. During network failures, the device can still operate normally with the physical button.



ENERGY MONITORING

View real-time power consumption and energy usage records of the connected devices.



SAFETY FEATURE

Automatically cuts off the power when an overload is detected, improving the device condition in the long run, protecting the device from damage.



APP CONTROL

The on/off status of the switch can be controlled remotely through the app.



SCENE CONTROL

Include this device as part of your desired home automation when a scene command is triggered.

CERTIFICATION



This product is RCM certified, ensuring compliance with Australian safety and regulatory standards.

VOICE ASSISTANT



Siri Shortcut



Google Assistant



Alexa

2. PRODUCT OVERVIEW

PRODUCT MODEL & VARIATIONS



GLASS WHITE

KGD-K118-1S-M-GLA-WH-Z

SKU: KSS00523

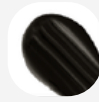

PLASTIC BLACK

KGD-K118-1S-M-PC-BL-Z

SKU: KSS00525

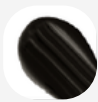

GLASS BLACK

KGD-K118-1S-M-GLA-BL-Z

SKU: KSS00524

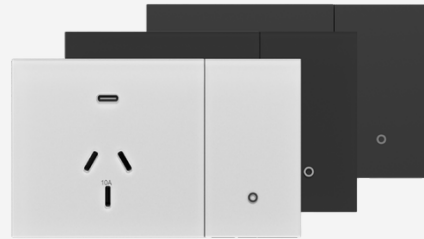

DIMENSIONS

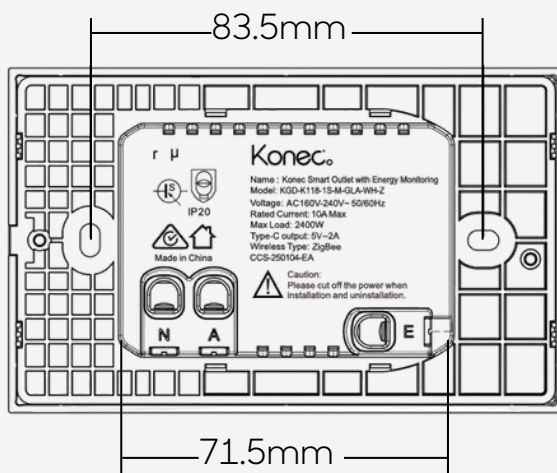
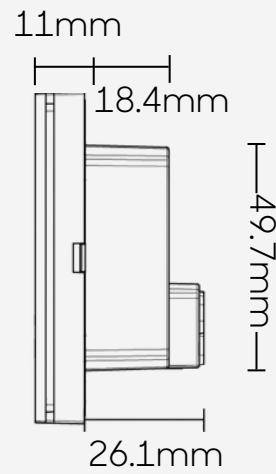
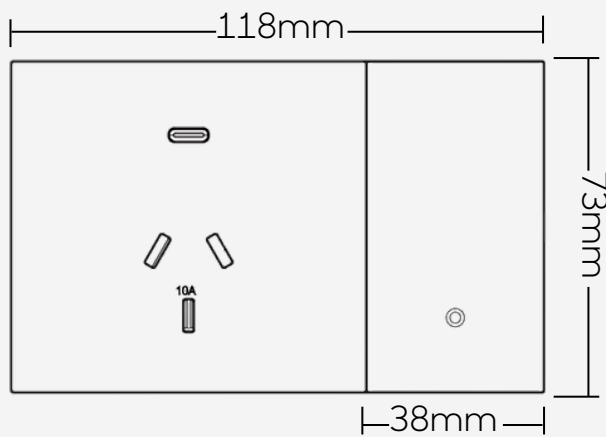

Disclaimer: Dimension size for the panel may slightly vary depending on the material and model type.

2. PRODUCT OVERVIEW

EXPLODED VIEW

**PLASTIC
BLACK**

**KGD-K118-2S-
PC-BL-Z**

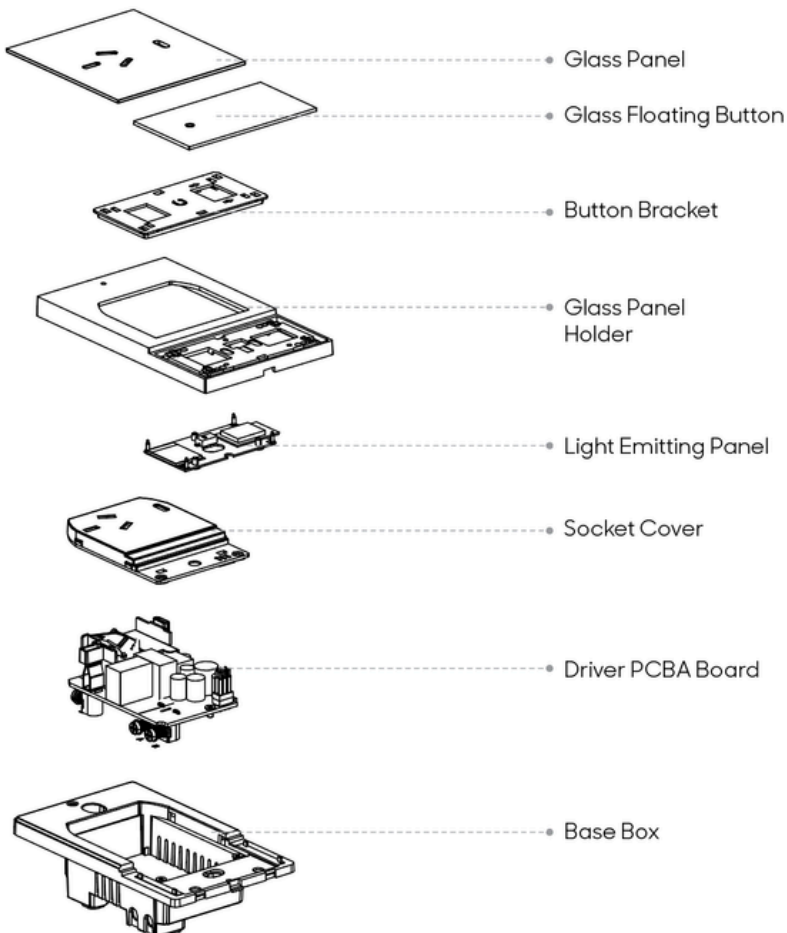
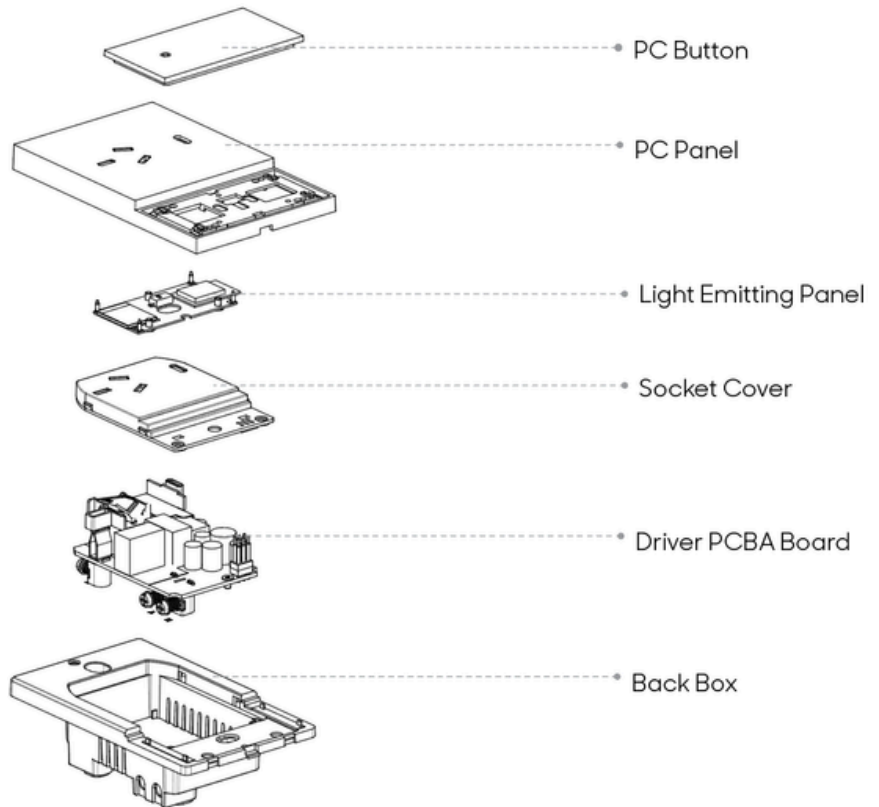

**GLASS
WHITE**

**KGD-K118-1S-
M-GLA-WH-Z**

**GLASS
BLACK**

**KGD-K118-1S-
M-GLA-BL-Z**

2. PRODUCT OVERVIEW

SPECIFICATIONS

Name	Parameter
Input Voltage	AC160V - 240V, 50/60Hz
Rated Current	Max. 10 A
Max. Load	Max. 2400 W
Type-C Output	DC 5V/2A
Connection Type	Zigbee
Dimensions	118 x 73 x 37.5mm
Energy Monitoring	Supported
Detection Reading	Min. 0.01kWh
Remote Control	Zigbee gateway required
Operating Environment	Temperature: -10°C ~55°C Humidity: ≤ 80%RH(Non-Condensing)
Storage Environment	Temperature: -10°C ~55°C Humidity: ≤ 80%RH(Non-Condensing)

3. SETUP

WHAT'S INCLUDED

SMART SWITCH * 1



Note: This image is for reference. Colour and finish will vary based on what was ordered.

SCREWS * 2



PAINTING PROTECTION COVER * 1



IN-BOX USER MANUAL * 1

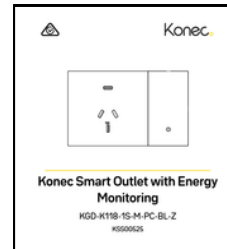

WIRING DIAGRAM



CAUTION: PLEASE CUT OFF THE POWER WHEN WIRING.

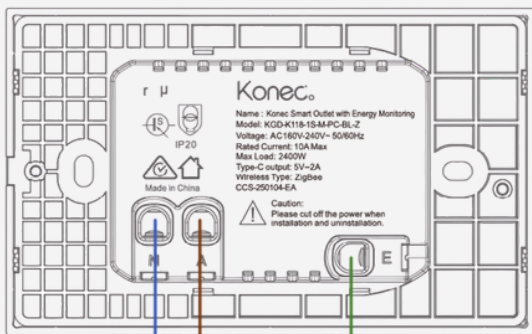

Active Wire

Earth Wire

Neutral Wire



Neutral wire, Active wire and Earth wire is required.



Active Wire and Neutral Wire Required



Active Wire



Neutral Wire



Earth Wire

3. SETUP



Household and indoor uses only, installed by a qualified professional.

Cut-out Requirements

11mm

18.4mm

27.1mm

Cavity

⚠ Ensure the cavity space is sufficient to fit all of the wires.

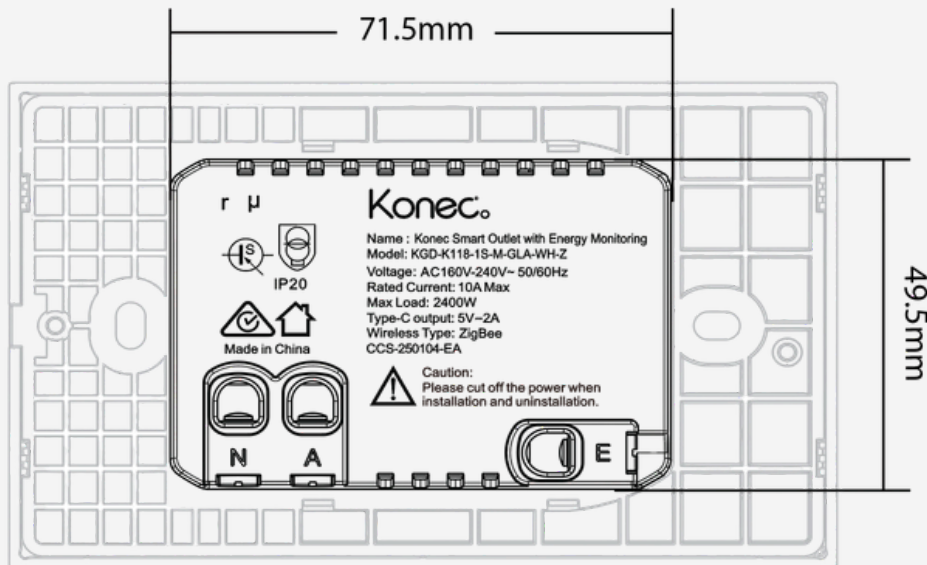

Special Circumstances

Disclaimer: The cut out dimensions and requirements may vary for surfaces such as **marble or tile**. Cut out spacing may need to include spacing for the screw holes.

Include the screw holes for the cut out spacing.

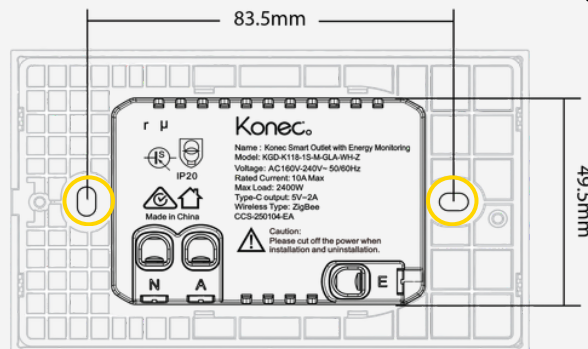

3. SETUP

INSTALLATION



DO NOT USE POWER DRILLING TOOLS. THIS CAN BEND AND DAMAGE THE DEVICE.

1. Use a screw driver to separate the panel and the base.

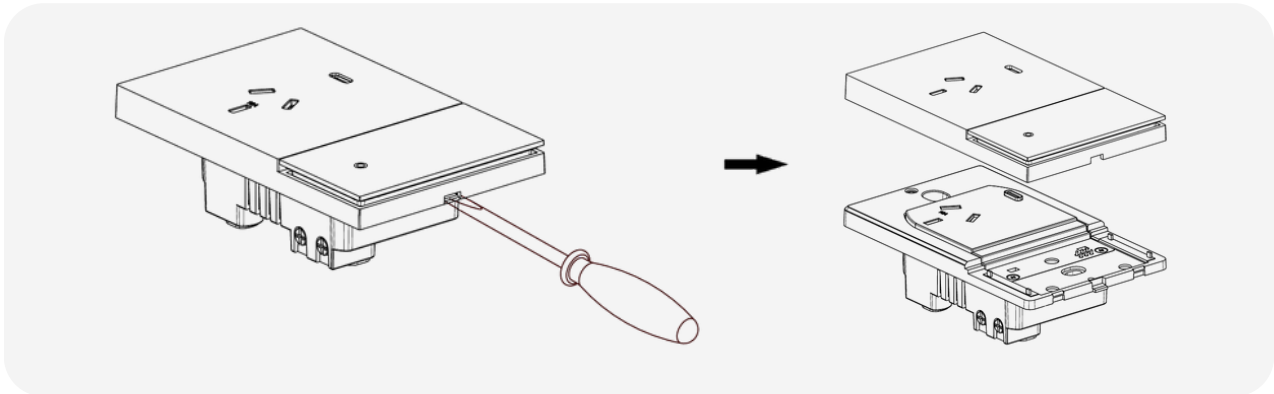

2. Prepare and connect the wiring. Refer to the Wiring Diagram (Pg.07).

- 2.1 **Active Wire** connects to "A" terminal.
- 2.2 **Neutral Wire** connects to "N" terminal.
- 2.3 **Earth Wire** connects to "E" terminal.

3. Screw the socket into the wallbox or plate on the wall, then snap the cover on it.

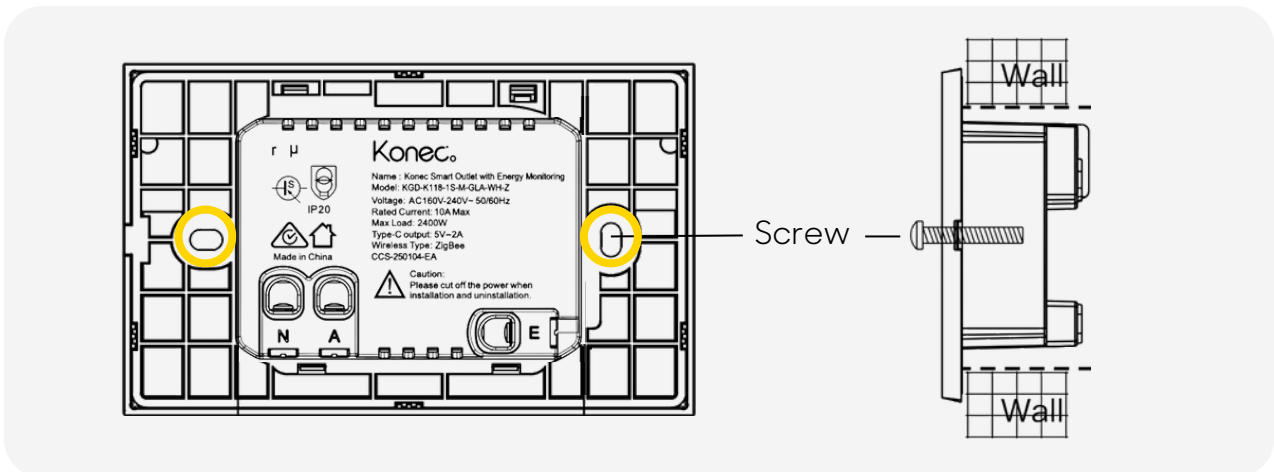

Disclaimer: This installation method may differ for surfaces like marble and tile.

4. CONFIGURATION



Disclaimer: All images and text provided below are intended for reference purposes only. Please note that this content is subject to updates, and both the text and images may change over time.

4.1 DOWNLOAD THE APP



IOS

Android

Scan the QR Code to download Arks by Konec Solutions App.

4.2 ADDING THE SWITCH TO ARKS

- 1 After powering on, press and hold the switch button for 10 seconds. The indicator light will blink, indicating that the device has entered pairing mode.



- 2 On the app, tap on the home list and select the home you wish to pair with the device.

✳ If you want to add it in a new home, please reference to the "Konec Arks APP User Guide" to create a new home.



✳ Ensure that a gateway is installed properly and added to the Arks App. Please refer to the User Manual for the corresponding gateway installation and pairing.

- 3 Tap on the " + " icon and then tap [**Add Device**].

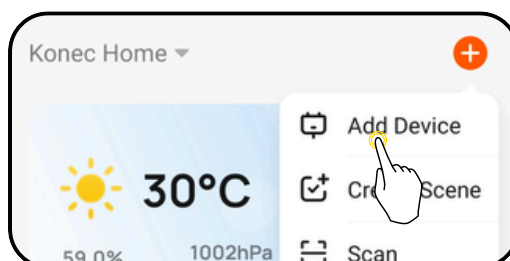

4. CONFIGURATION

- 4 Tap on [**Electrical**], and then tap [**Smart Power Point - Single channel - Energy Monitoring**]. Choose the gateway you wish to pair with the device.

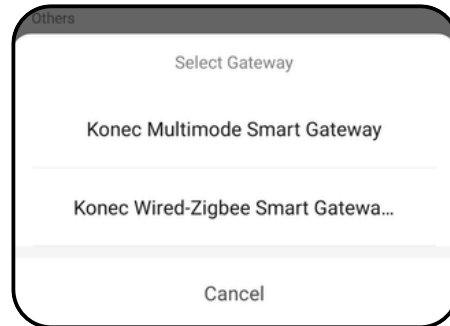
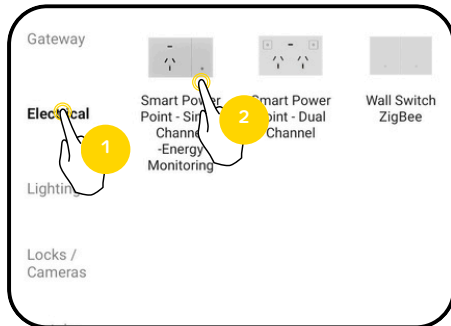

- 5 Tap the reset status confirmation and tap [**Next**]. The app will scan for the device.

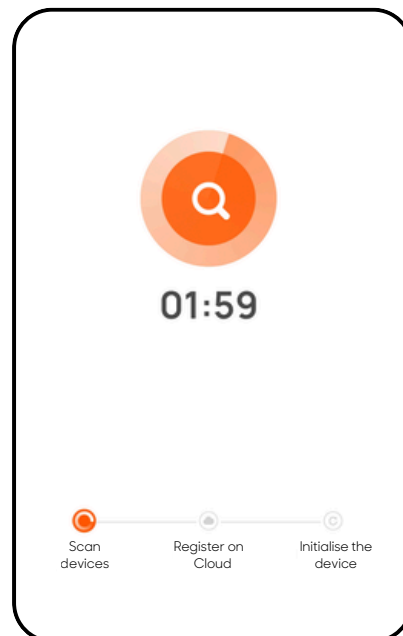
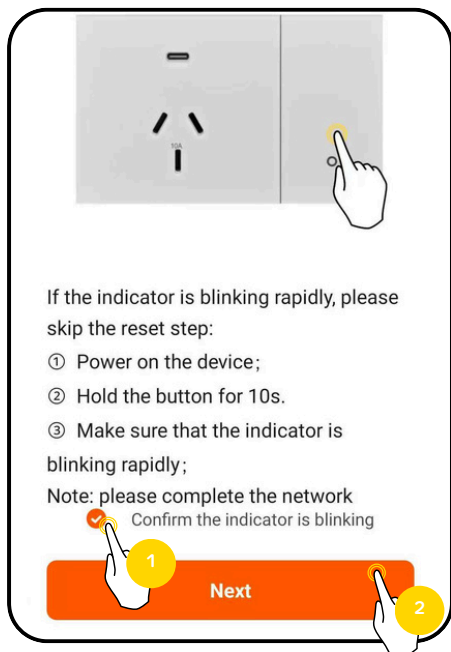

- 6 Device will be automatically detected and appear once the Pairing Operation is successful. Tap [**Done**] to complete. The device should appear on the Dashboard.

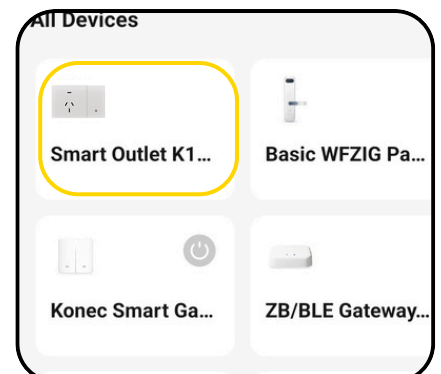
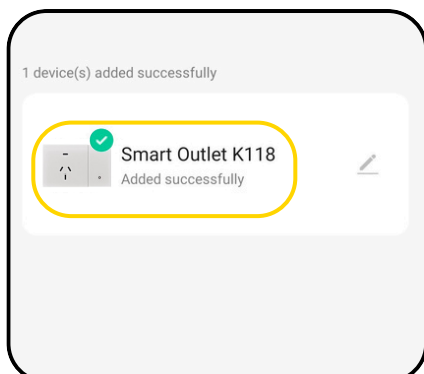

4. CONFIGURATION

4.3 DEVICE CONTROL PAGE

Directly access and control the settings and functionalities of the Konec Smart Outlet with Energy Monitoring. Special features include adjusting settings, viewing status, or performing setup configurations.

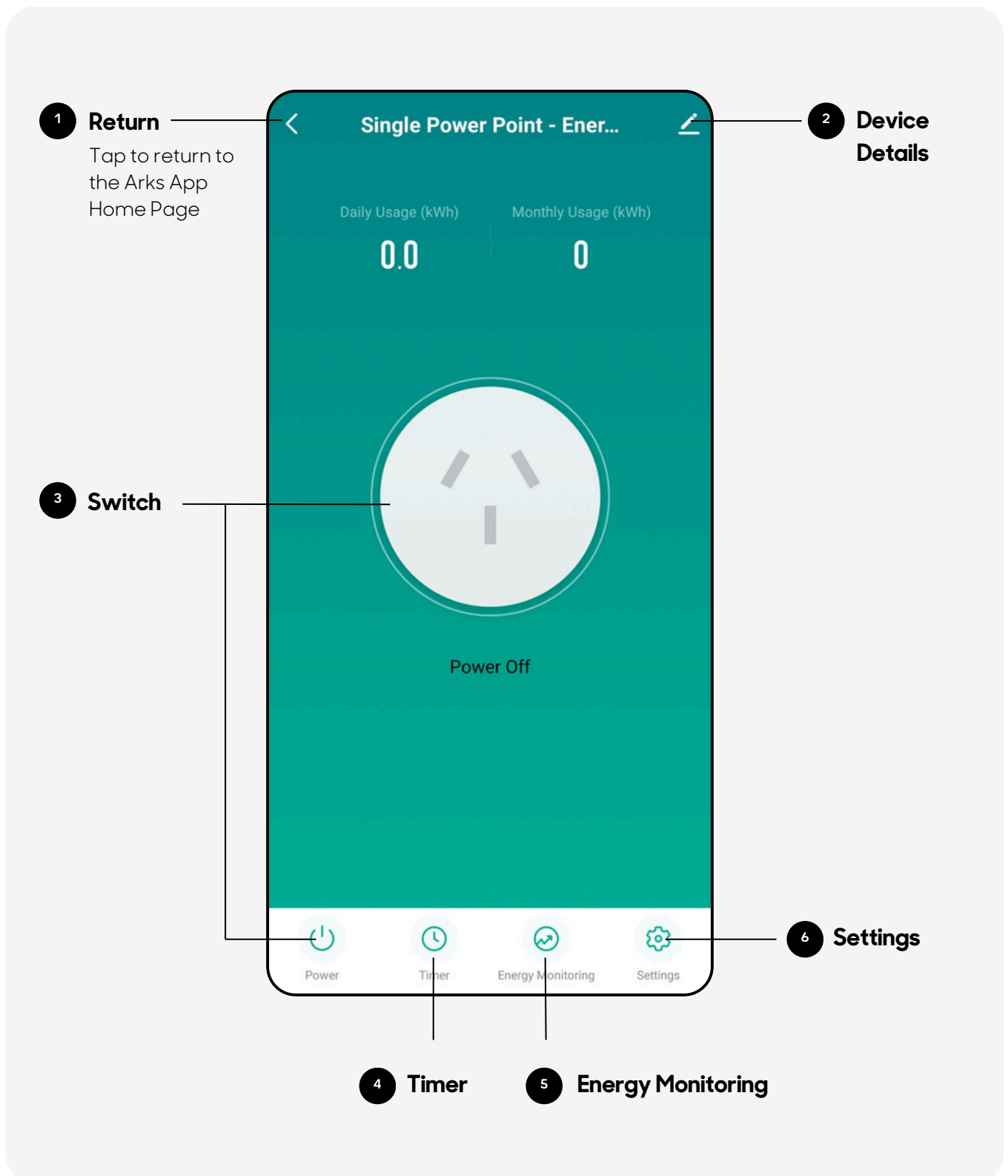

4. CONFIGURATION

1 RETURN

Tap the Return icon “<” to go back to the Home Screen.

2 DEVICE DETAILS

Access the Device information and other information.

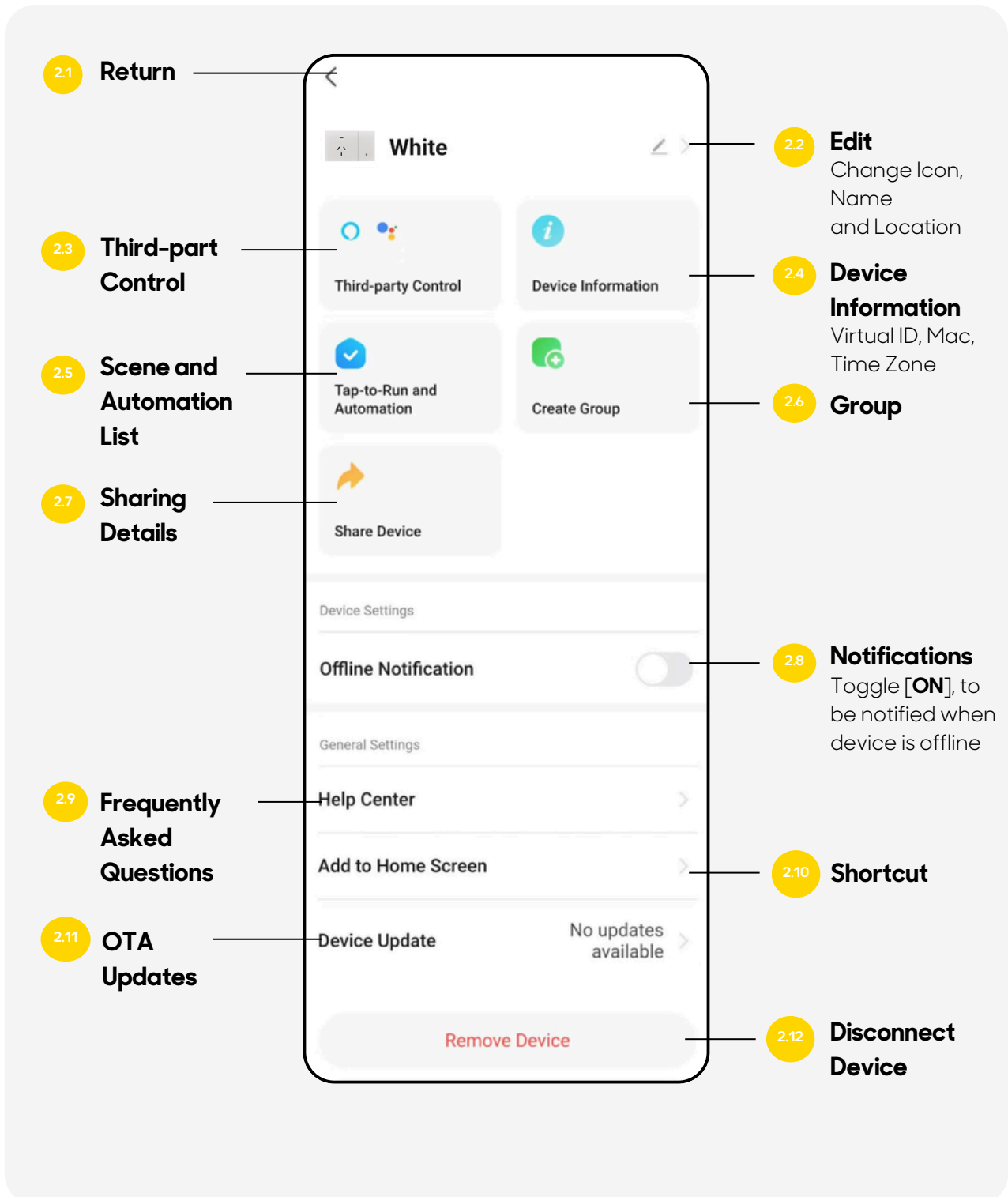

4. CONFIGURATION

2.1

Return

Tap the Return icon “ < ” to go back to the Device Interface.

2.2

Edit

Tap the Signature icon “ ⌵ ” to change Icon, Name and Location of the device.

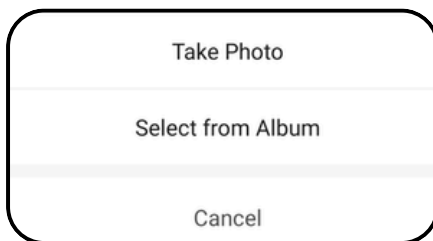
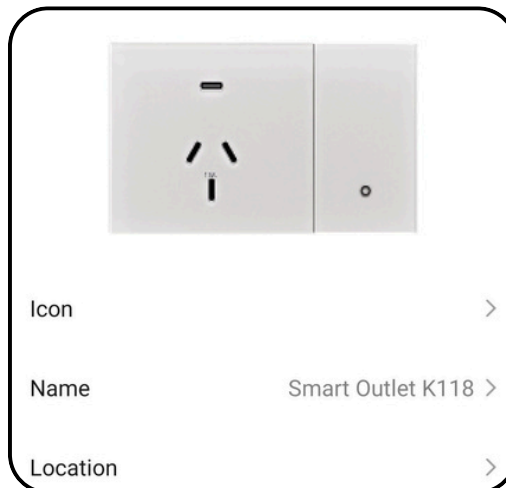

Icon

Update display icon with an icon from a photo or your phone.

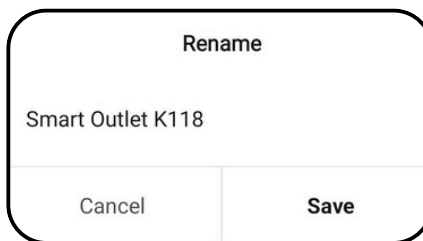

Name

Change the display name.

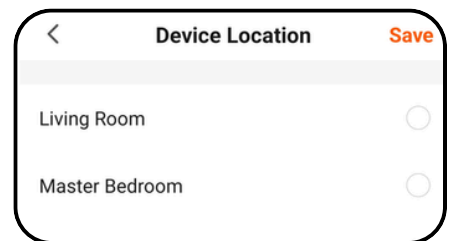

Location

Select where the device is located.

2.3

Third-part Control

Third-party device control connection.

2.4

Device Information

Obtain the information about Virtual ID, Mac, and Time Zone.

2.5

Scene and Automation List

View the list of Scenes and Automations that this device is included in.

You can tap [**Tap-to-Run and Automation**] to view the list of Scenes and Automation.

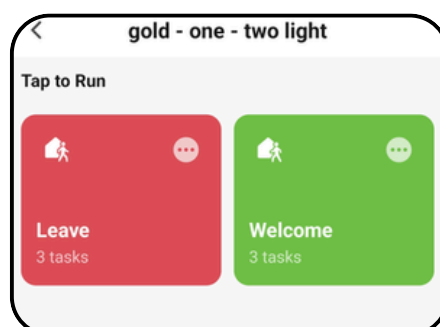

4. CONFIGURATION

2.6

Group

Create a group where you can control the selected devices together.



Note: Both devices must be paired under the same gateway to allow Group feature.

1. Tap [**Create Group**].
2. Under "**Devices to be Added**", tap on the "+" of the device you will to group.
3. Tap [**Save**].

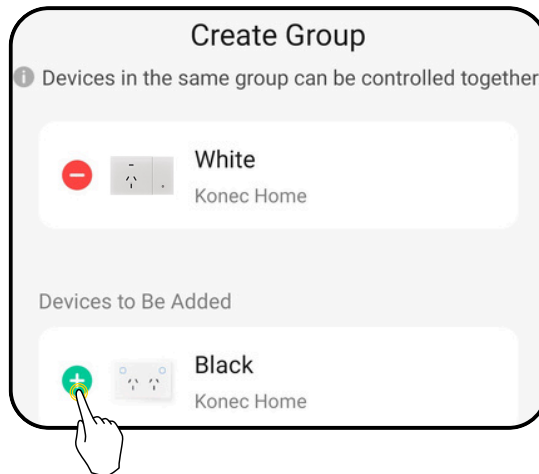

2.7

Sharing Details

Details on how to share this device's access and control with other users.



Note: Sharing methods that solely share one device in your smart home is not supported. You would need to **Add a Member** to your Smart home to access the device.

Sharing Method Not Supported

Currently, you cannot use the specified method to share Bluetooth mesh devices, Zigbee devices, infrared devices, Bluetooth Beacon devices, and certain Bluetooth LE devices with other users.

Recommended Sharing Method

If the recipient is a home member or a reliable user, tap Me > Home Management > Add Member and add the recipient to your home. Then, devices in the home can be shared with the recipient in bulk.

2.8

Notifications

Receive phone notifications when this device's status changes to offline.

To turn on this function, under "**Device Offline Notification**" toggle [**Offline Notification**] ON.



Note: Offline notification may experience delays.

2.9

FAQ Access a list of questions that are related to this product.

Tap [**More**] to access the general FAQ.

4. CONFIGURATION

2.10 Shortcut

Add a shortcut onto your phone home screen for easier access.

1. Tap [**Add to Home Screen**].
2. Tap [**Go**].
3. Tap [**Add**].

2.11 OTA Updates

Check for the latest firmware updates.

Toggle ON [**Auto Upgrade**], if you wish to automatically update the device when a new update is detected.

2.12 Disconnect Device

Remove and disconnect the device from your app.

Disconnect: You will remove the device and all related automation settings will be deleted. Tap [**Disconnect**] > [**Confirm**].

Disconnect & Wipe Data: You will remove the device and all related data will be deleted. Tap [**Disconnect and wipe data**] > [**Confirm**].

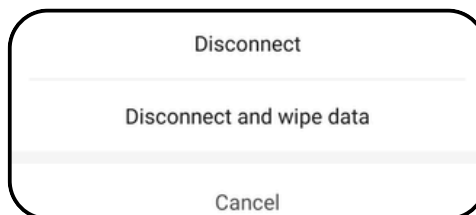

3 SWITCH FUNCTION

Tap one of the switch key to turn on and off the designated function. Both icon will change depending on the ON/OFF status.

OFF STATUS

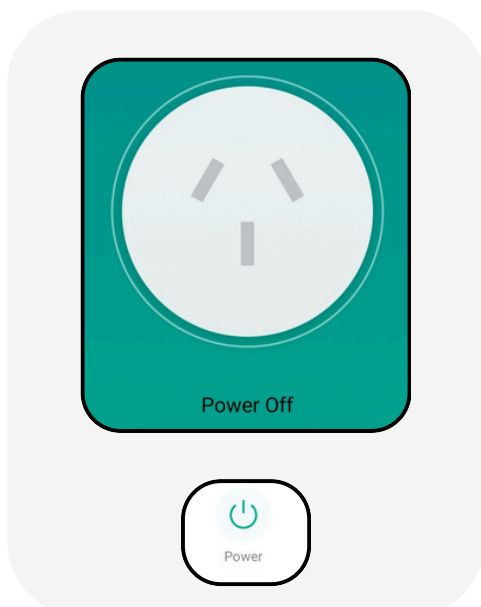

ON STATUS

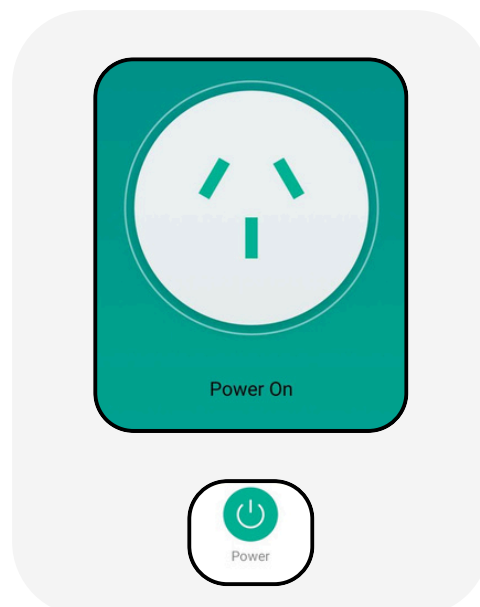

4. CONFIGURATION

4 TIMER

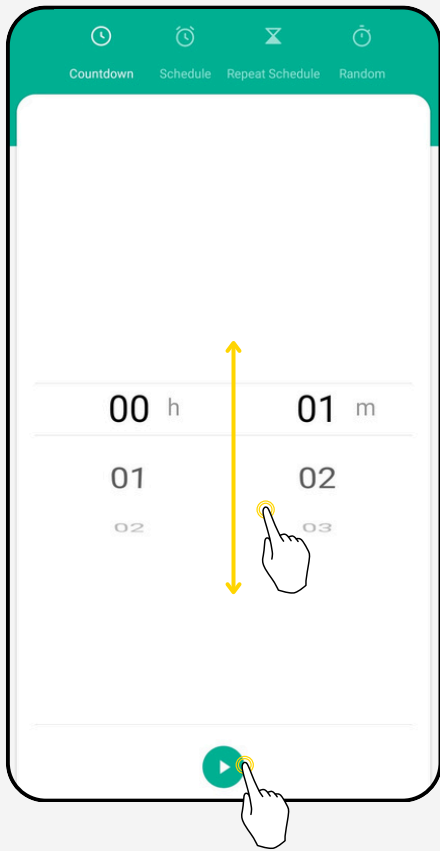

• Countdown:

Scroll to set time and press start icon "▶" to start.
Press [Reset] or "🗑️" icon to stop counting.

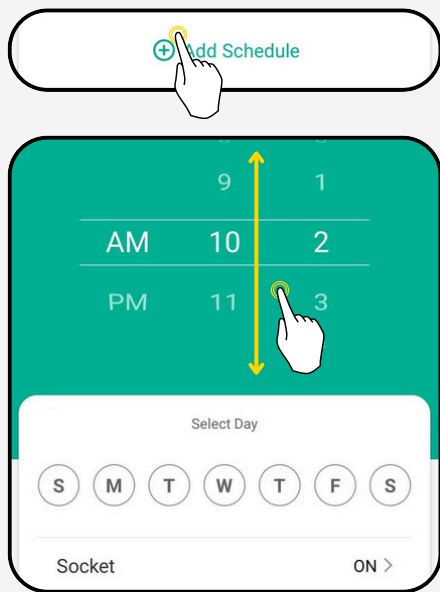
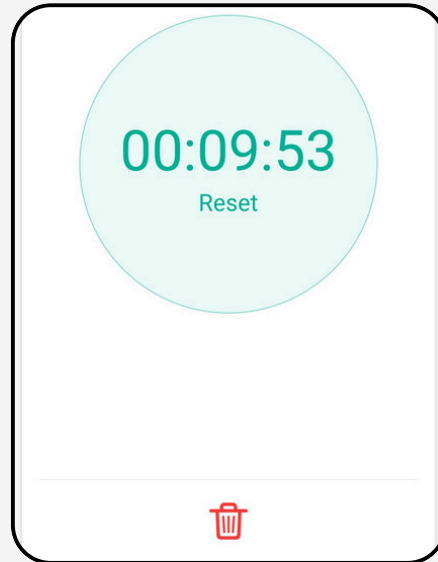

• Schedule:

1. Tap "+".
2. Scroll to set timer.
3. Set repeat and active.
4. Tap [Save].

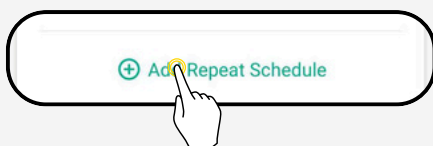
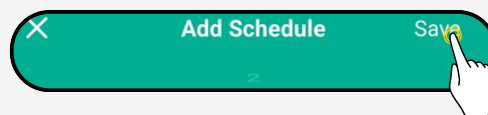

• Repeat Schedule:

1. Tap "+".
2. Scroll to set timer.
3. Set repeat and scroll to set duration.
4. Tap [Save].

4. CONFIGURATION

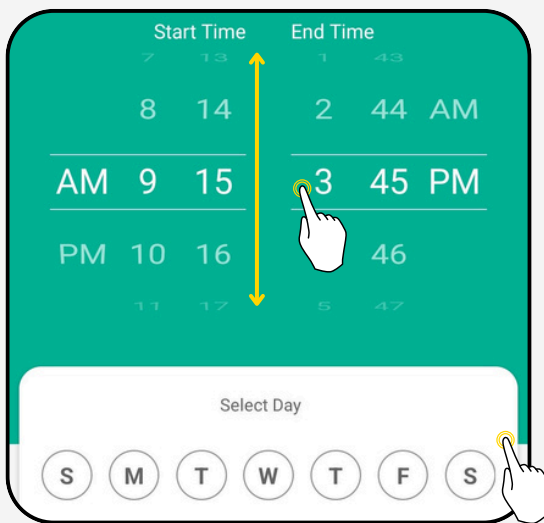
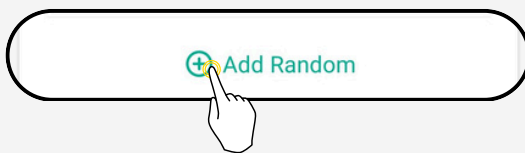
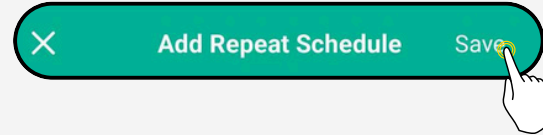
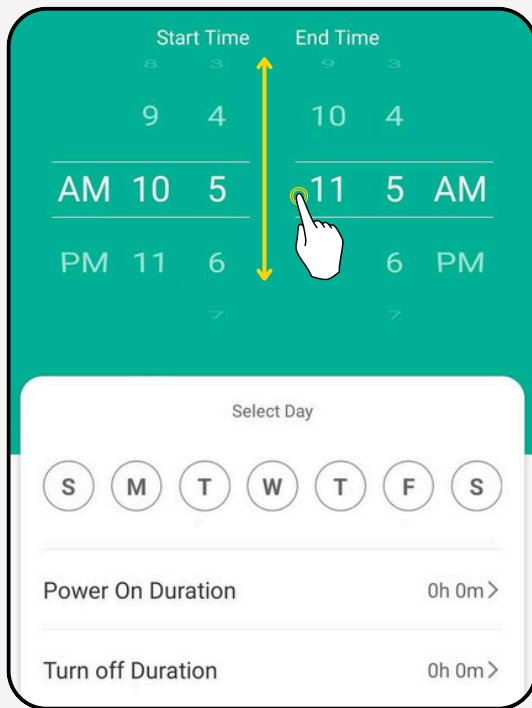

• Random:

1. Tap "+".
2. Scroll to set timer.
3. Set repeat.
4. Tap [**Save**].

Disclaimer: Routine Schedules are based on the cloud server. If the server fails, the schedules will not be activated.

4. CONFIGURATION

5 ENERGY MONITORING

The [Power Consumption] allows you to view power consumption.

Tap month/year to change the time scale.

Tap the specific scale to observe the electricity consumption of a certain day or month.

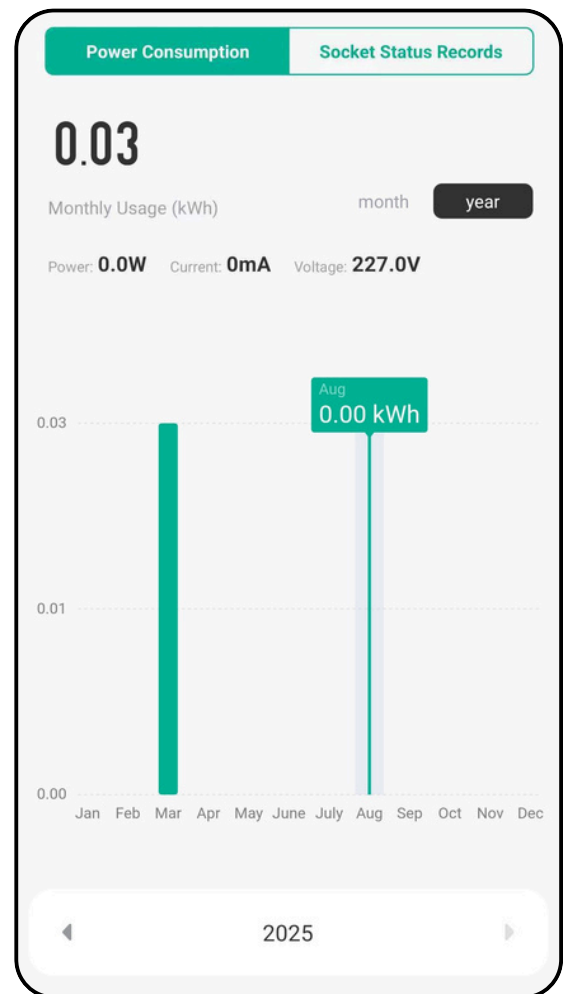
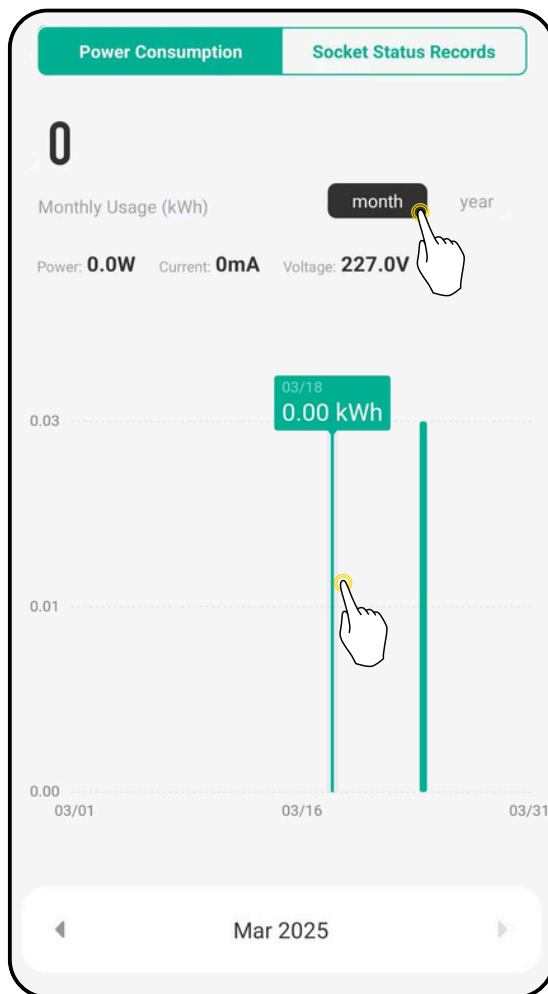

Tap on [Socket Status Records] to view the device status record.

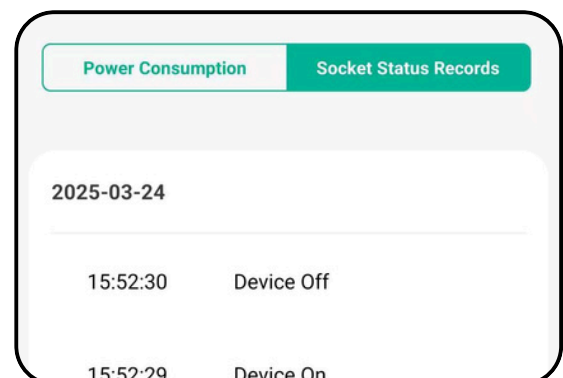

4. CONFIGURATION

6 SETTING

You can set the relay status and indicator light mode in setting interface.

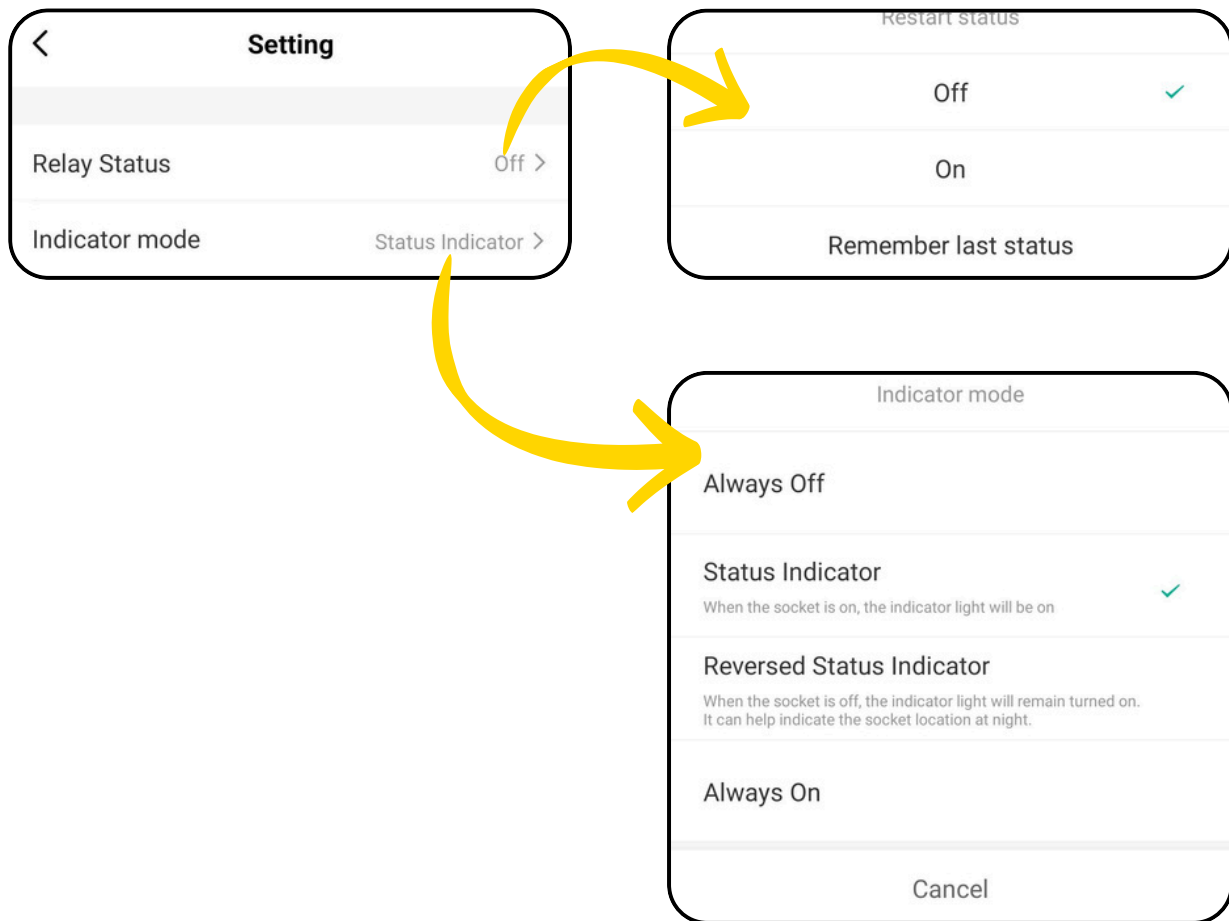

4. CONFIGURATION

4.4 REMOVE FROM ARKS

Remove and disconnect the device from your app.

1. On the Home screen, select the switch and tap on the **Device Details** icon "⌵".

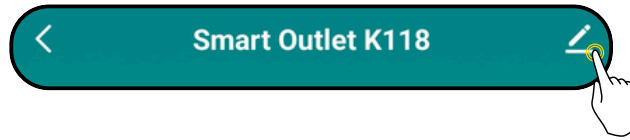

2. Tap on **[Remove Device]**.
3. Select which method you wish to remove the device:

- **Disconnect:** You will remove the device and all related automation settings will be deleted. Tap **[Disconnect]** > **[Confirm]**.
- **Disconnect & Wipe Data:** You will remove the device and all related data will be deleted. Tap **[Disconnect and wipe data]** > **[Confirm]**.

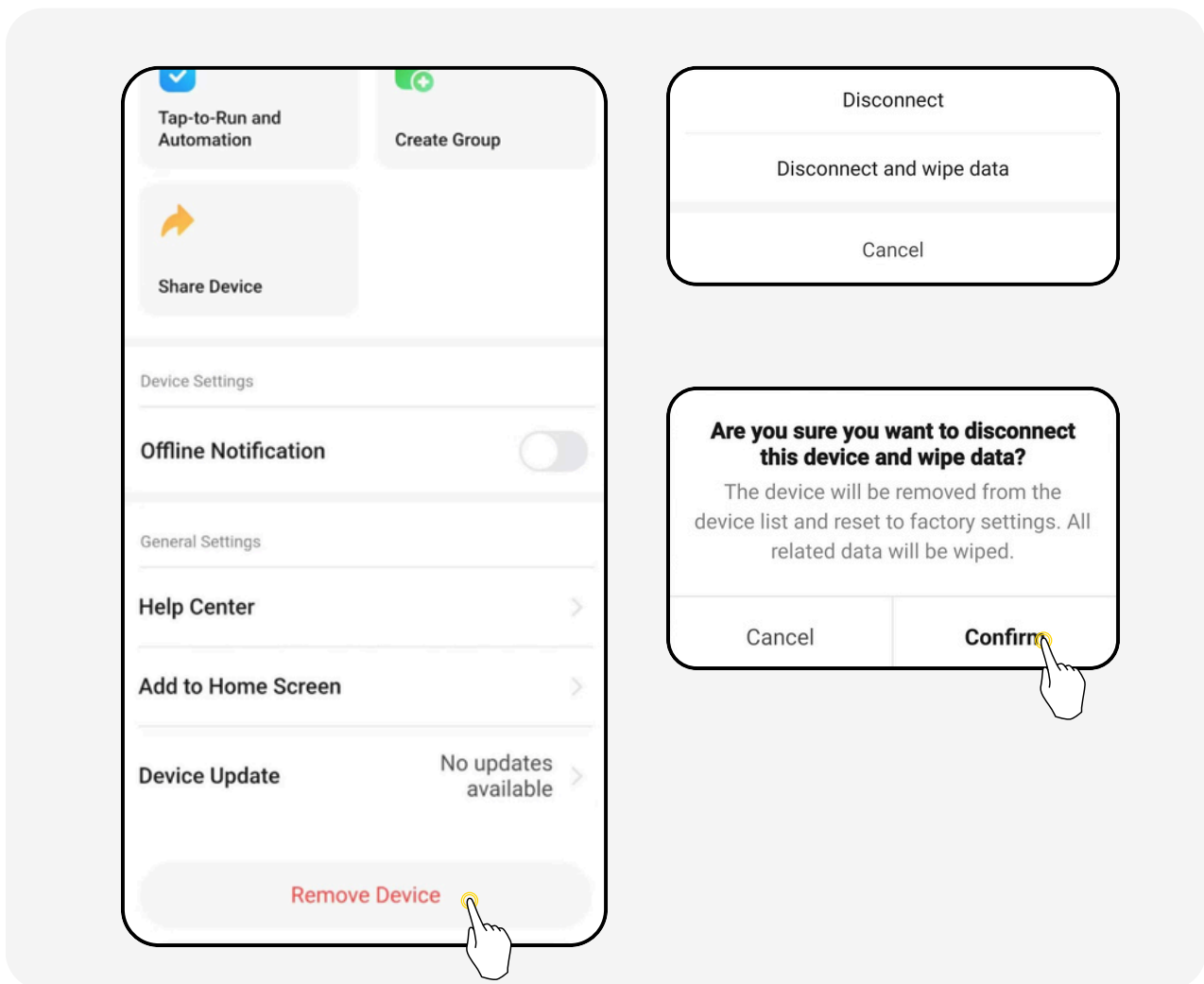

Disclaimer: Hard resetting the device will also remove the device from the Arks app.

5. SCENE

SCENE SETTING

1. On the Home Page, tap the [**Scene**] tab or [**+**] icon to access your **Automation** and **Tap-to-Run** List.
2. Tap [**Create Scene**].

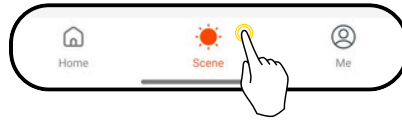

- **Condition:** If this device is used as a condition.
Tap [**When device status changes**], then tap this device in the list.

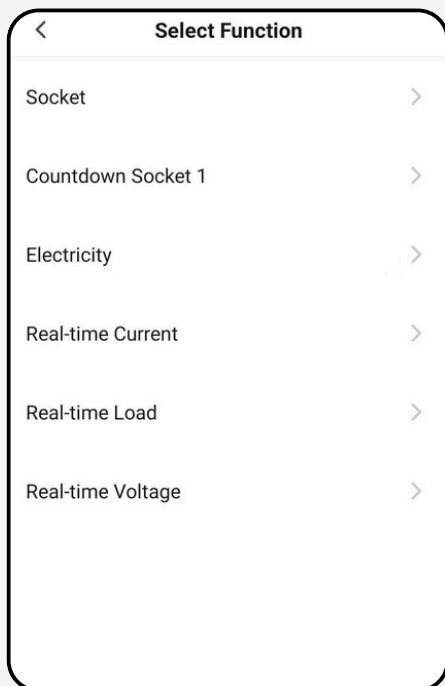
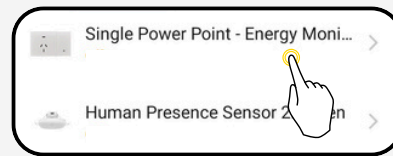
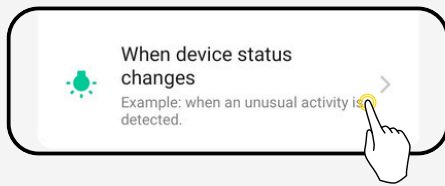

- [**Socket**]: Select switch status ON/OFF as the trigger condition.
- [**Countdown Socket 1**]: Set countdown time as the trigger condition.
- [**Electricity**]: Set power consumption as the trigger condition.
- [**Real-time Current**]: Set current as the trigger condition.
- [**Real-time Power**]: Set power as the trigger condition.
- [**Real-time Voltage**]: Set voltage as the trigger condition.

5. SCENE

- [Add Task]:



Select which device you want to activate when the scene is triggered.

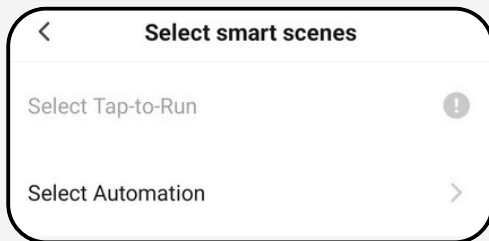
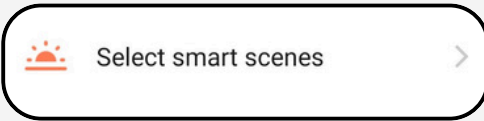

Link to another Smart scene to be activated when this scene is triggered.

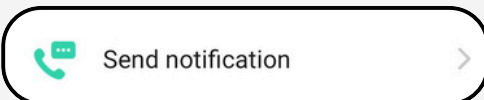

Receive phone notifications when this device's status changes.

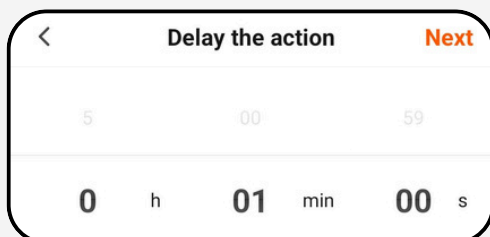
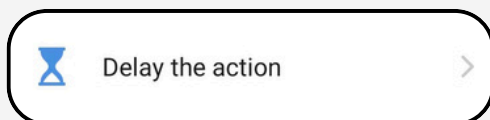
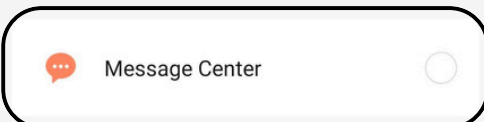

Set a delayed response where the selected devices will trigger after the set time.

5. SCENE

- **Assignment:** If this device is used as a controlled party.
After setting the condition, tap " + " icon to add task.
Tap [**Run the device**], then tap this device in the list.

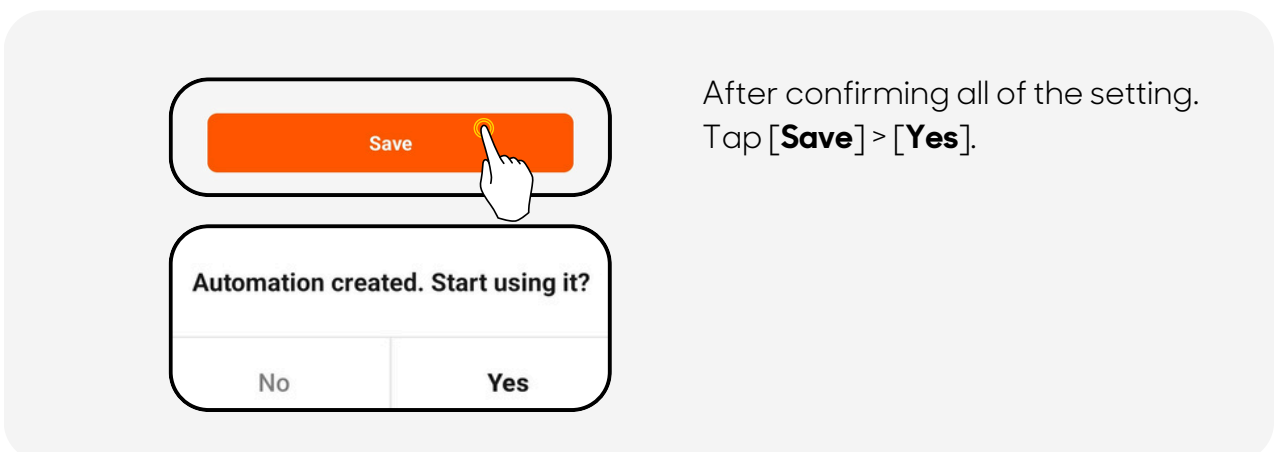
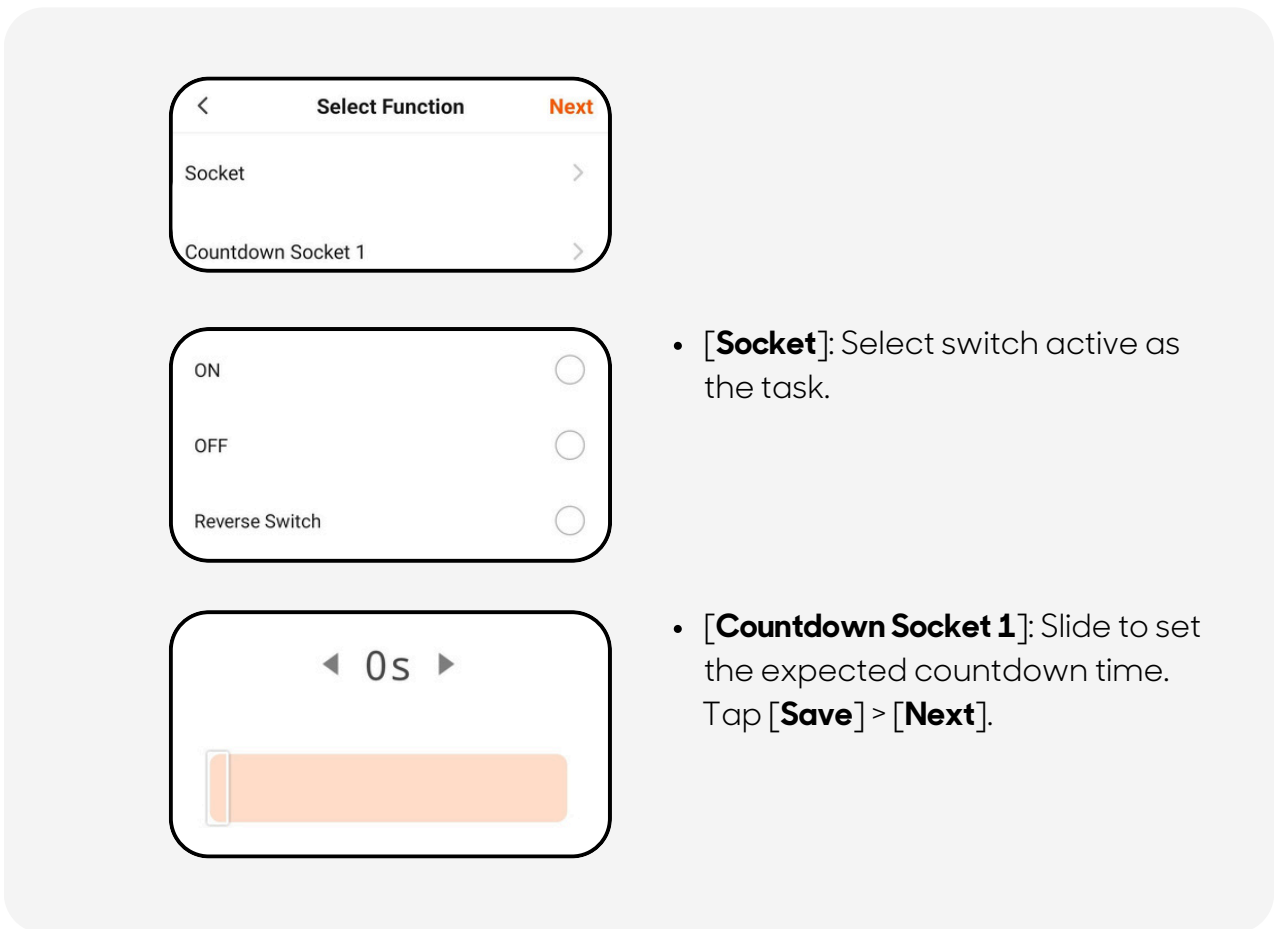
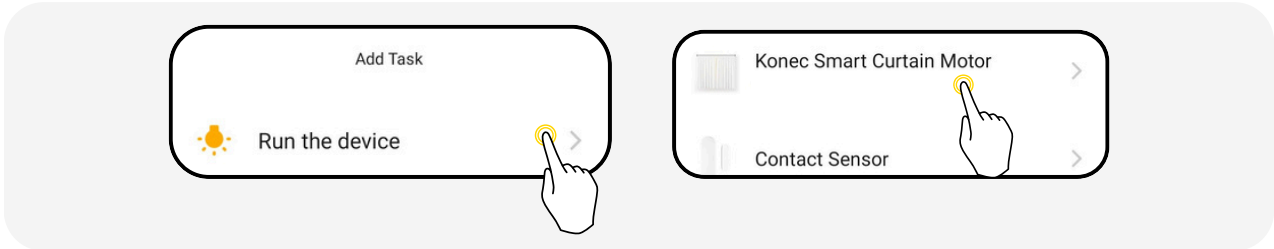

5. SCENE

- [Setting the condition]:

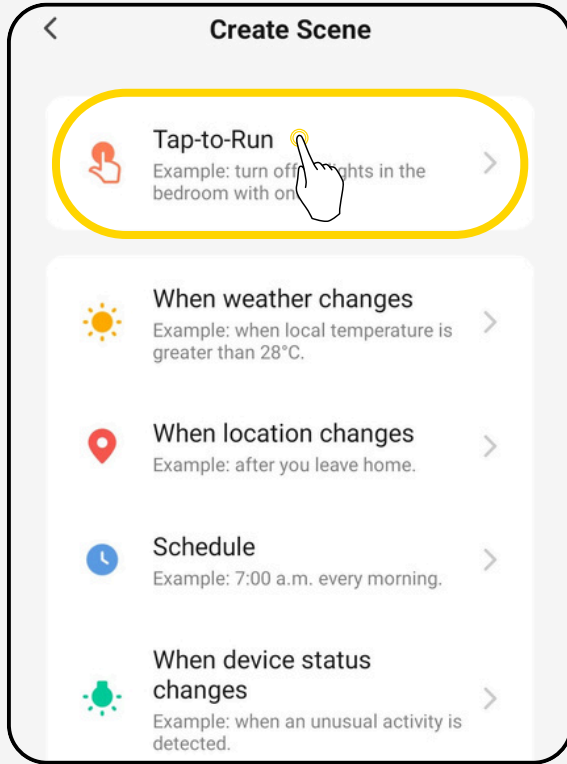

Tap-to-Run

If the scene icon is tapped, the selected devices will activate according to the set task.

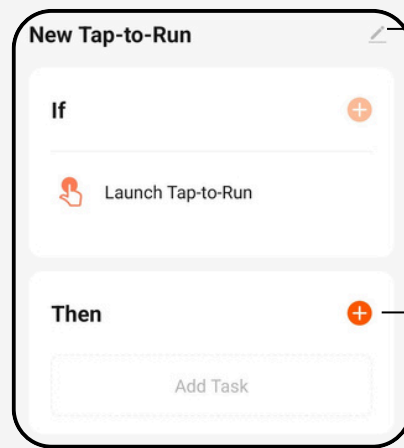

1 Edit

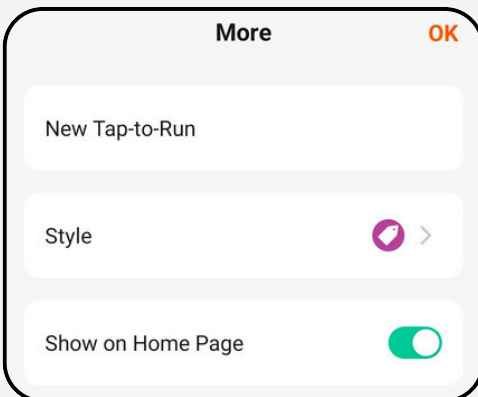

Enter Scene Name: Rename the scene for easier identification.

Style: Choose the colour and icon theme for the scene.

Show on Home Page: Toggle On or Off to display scene on the Home page.

2 Add Task

Refer to Pg.22

5. SCENE



When Weather Changes

Activate automated scenes based on the live environment readings within your Smart Home.

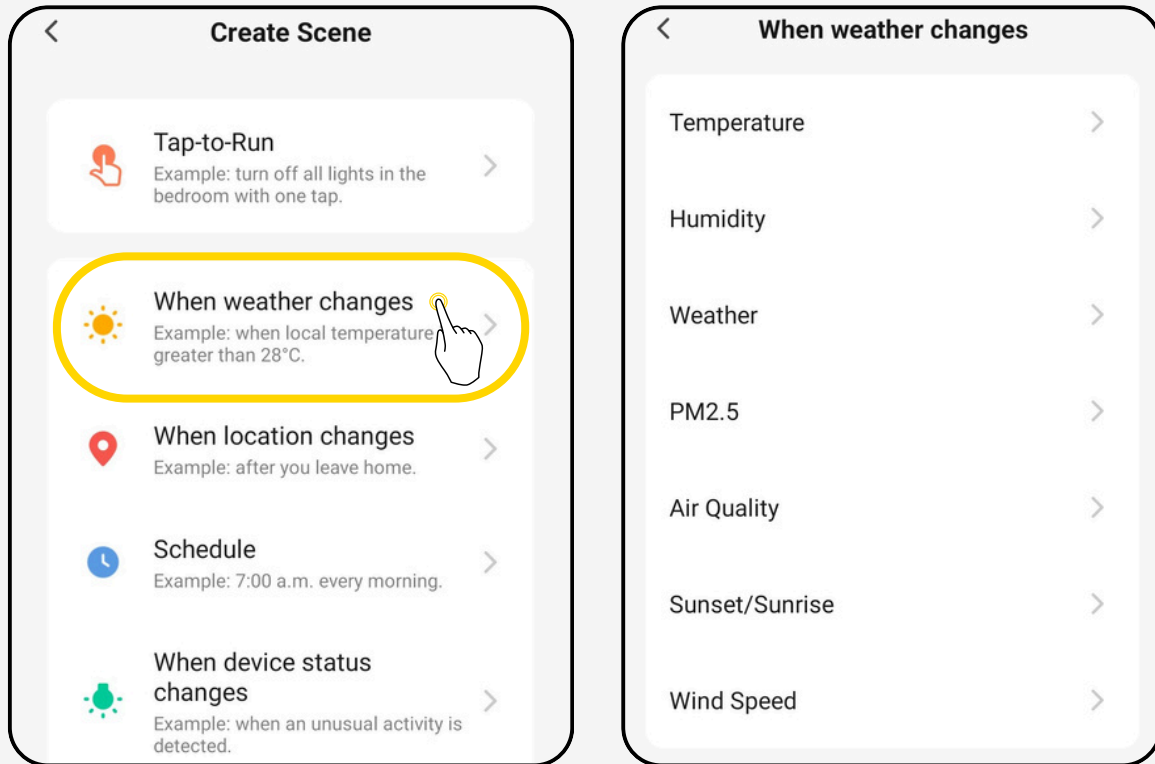

1. Select the environment condition you would like to trigger the scene automation.
2. Tap [**Current City**] and confirm your address location.
3. Select the environment conditions you would like to trigger the scene.
4. Under **Add Task**, select the desired task.
5. You can rename the scene by selecting the [] icon.
6. Tap [**Save**] and the scene will be added.

5. SCENE

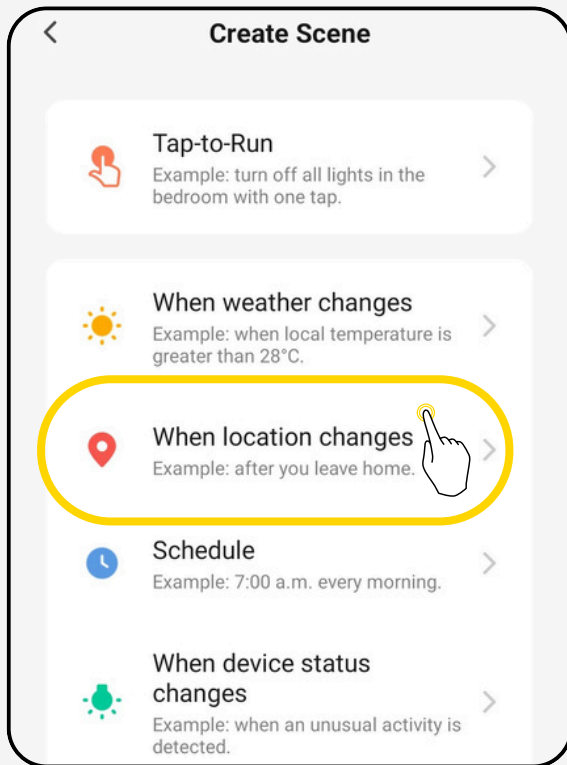

When Location Changes: Activate automated scenes depending on your location; inside or outside your Smart Home.

Note: This function requires constant access to your location on your mobile to activate the scene. This access will not be collected or stored. This is a Beta Testing version.

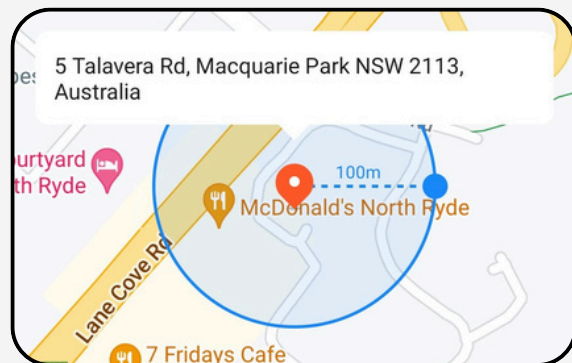
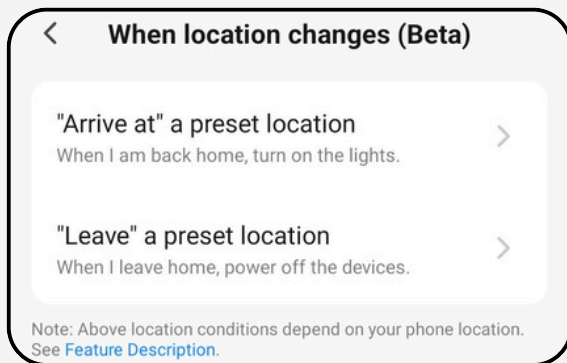

1

2

1 Select the condition on when the scene should activate:

Arrive: When you arrive home, the device will activate.

Leave: When you leave the vicinity, the device will activate.

2 Select the condition on when the scene should activate:

1. Select [**Arrive at**] or [**Leave**].

2. Confirm the Smart Home location.

3. Touch and drag the blue circle to confirm the detection proximity.

4. Tap [**Confirm**].

5. Under **Add Task**, select the desired task.

6. You can rename the scene by selecting the [**↗**] icon.

7. Tap [**Save**] and the scene will be added.

5. SCENE

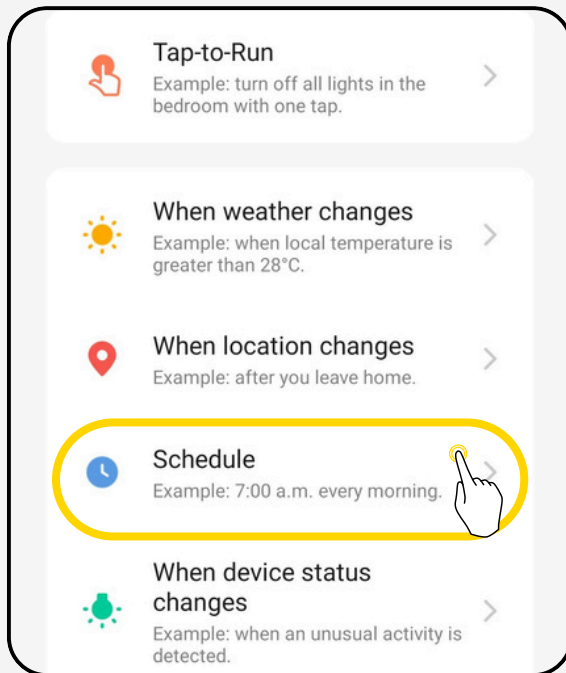

Schedule: Set a repeated time schedule which will automatically activate when it reaches the set time.

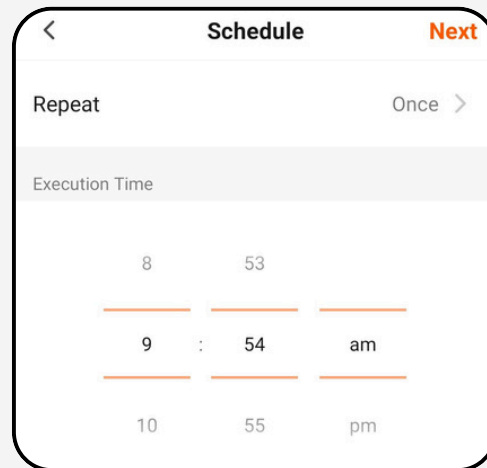

1. Tap on [**Repeat**] > Select which day of the week you wish for the device to activate.
2. Set the Execution time > Tap [**Next**].
3. Under **Add Task**, select the desired task.
4. You can rename the scene by selecting the [**↵**] icon.
5. Tap [**Save**] and the scene will be added.

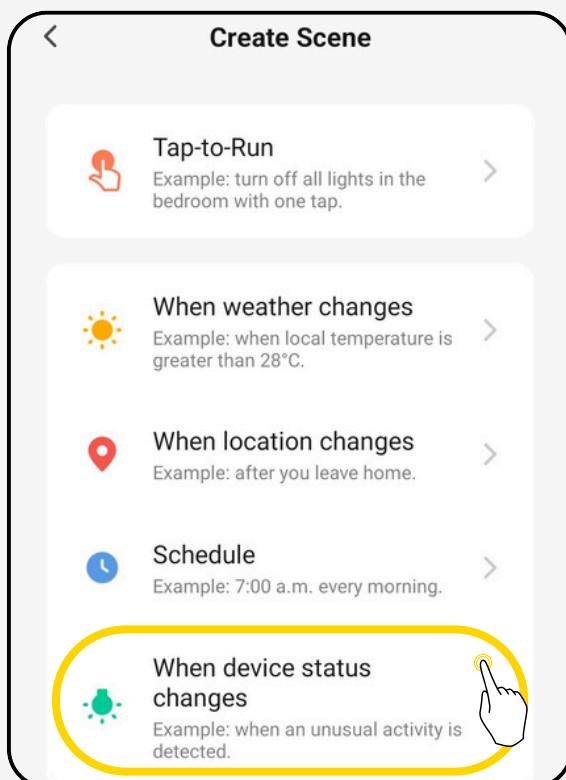

When device status changes: Automatically trigger the automation when the status on a smart devices changes and notifies the system.

1. Tap on [**When device status changes**] and select the smart device.
2. In the **Select Function** page, adjust the settings based on your preference.

Note: In the Select Function page, all devices settings will differ according to its functions.

6. INDICATOR LIGHT STATUS

INDICATOR LIGHT STATUS (DEFAULT MODE)

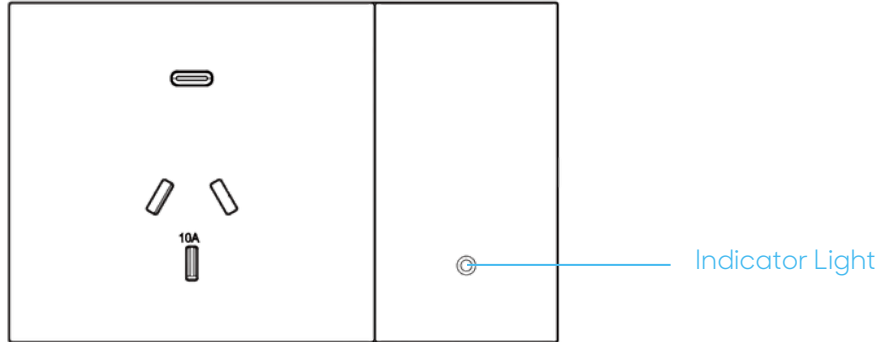

Light Status	Meaning
The light indicator flashes continuously and quickly.	The socket is currently on the status of configuring.
The light indicator lights up constantly.	Depending on the indicator mode: Always ON, Follow the socket status and keep it constantly on when the socket is powered on, Under night mode, when the socket is powered off, the indicator light constantly on.
The light indicator is off.	Depending on the indicator mode: Always OFF, Follow the socket status and keep it constantly off when the socket is powered on, Under night mode, when the socket is powered on, the indicator light constantly off.

7. CONTACT US

Search for "Arks" in the App Store or Google Play, or scan the QR code below to download and install the App. Click "Register" to register a new account if this is your first time to use; if you already have an account, click "Login"

Scan the QR Code to download Arks by Konec Solutions App.



IOS



Android

Konec Solutions Pty Ltd

Please do not hesitate to contact us if you have any questions.



Konec Official Web

<http://www.konec.com.au>



Hotline

1300 2 56632 (1300 2 KONEC)



Sales & Partnership

sales@konec.com.au



Customer Support

support@konec.com.au



Address

L3 5 Talavera Road Macquarie Park NSW 2113
