

ES20 SERIES

High Security Electric Strikes - Australian Footprint

ES20 DESCRIPTION

The **LOX ES20** Series high security Electric Door Strikes are one of the most successful commercial Electric Strike products in Australia. It is manufactured from stainless steel, accepts D.C. Voltages from 10 to 30 VDC and is site interchangeable from Fail-Secure to Fail Safe (Power to Release to Power to Lock) by only using a small screw-driver.

The **ES20** Series Strikes have a 10mm strike lip as standard. This prevents potential personal injury and damage to clothing as compared to Electric Strikes with a 15mm strike lip.

All **ES20** Series Strikes are pre-drilled to take extension lips in various sizes.

The **ES20M** Electric Strike is one of the strongest Electric Strikes in its category.





ES20
NON MONITORED HIGH SECURITY STRIKE

ES20M
MONITORED HIGH SECURITY STRIKE

ES20M MONITORING:

LOCK STATUS MONITORING (LSS) = LOCK LOCKED/UNLOCKED
DOOR STATUS / LATCH MONITORING SENSORS = DOOR OPEN/CLOSED
ANTI-TAMPER-MONITORING = STRIKE SECURELY INSTALLED/STRIKE TAKEN OUT OF FRAME

SPECIFICATIONS

ES20	AUSTRALIAN PROFILE NON MONITORED DOOR STRIKE. MORTICE MOUNT, POWER TO LOCK/POWER TO OPEN FIELD INTERCHANGEABLE CAPACITY.
ES20M	MONITORED VERSION OF THE ES20
HOLDING STRENGTH	UP TO 1100KG, TESTED TO 1.5 MILLION CYCLES
VOLTAGE/CURRENT	MULTI VOLTAGE 10—30VDC, 250mA AT 12VDC, 125mA AT 24VDC
APPROVALS	UP TO 4 HOUR FIRE RATED TO A.S STANDARDS, CE & C-TICK  
LSS MONITORING	STATUS SENSOR OF THE INTERNAL LOCKING MECHANISM
DSS MONITORING	DOOR LATCH SENSOR, DOOR LATCH ENGAGED WITHIN STRIKE KEEPER
ATS MONITORING	DOOR STRIKE REMOVED OR REPOSITIONED SENSOR
ENVIRONMENTAL	OPERATIONAL TEMPERATURE RANGE - 20 DEG. C TO 60 DEG. C.



ES20 SERIES

High Security Electric Strikes - Australian Footprint

PRODUCT DIMENSIONS

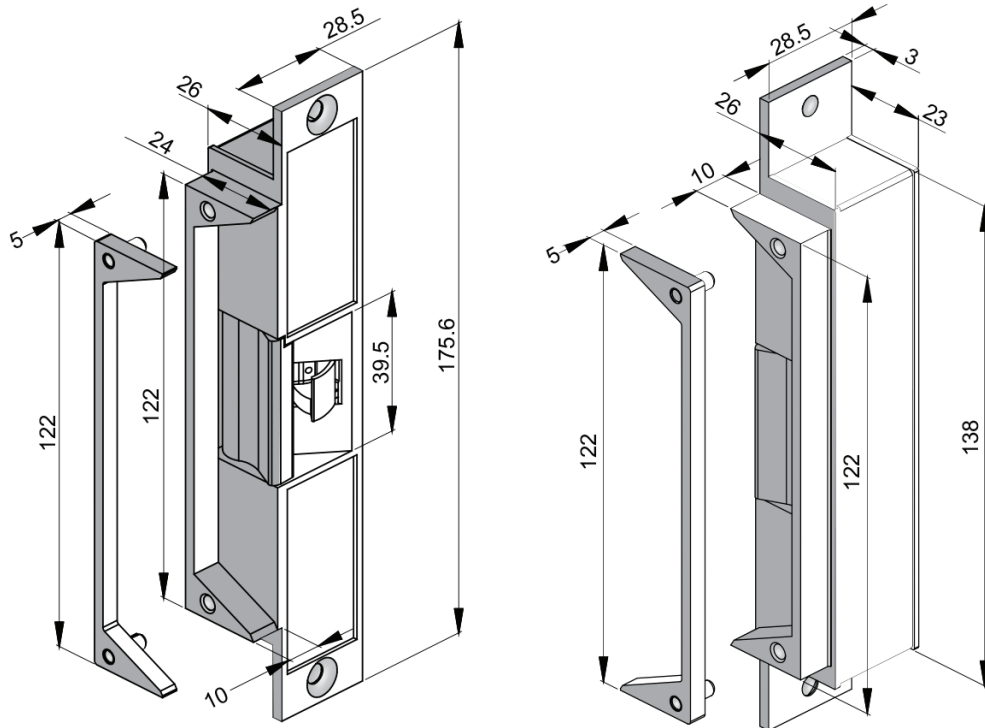

Dimensions (mm)

ES20 FACTS

- 5 year warranty
- Simple Power To Lock/Power To Release interchange
- No loose pins and springs
- 10mm strike lip pre-drilled for extension lips
- Multi-Voltage: 10-30VDC
- Fire rated CE & RCM Approvals
- Superior holding strength

ACCESSORIES



ES20-EL15

LOX ES20 EXTENSION LIP 15MM

ES20-EL25

LOX ES20 EXTENSION LIP 25MM

ES20-EL50

LOX ES20 EXTENSION LIP 50MM

ES20-EL75

LOX ES20 EXTENSION LIP 75MM



ES20REBATE

LOX ES20 STAINLESS STEEL 13MM REBATE KIT

LOX
LOCKING

LOX LOCKING PTY LTD | www.loxlocking.com.au

LOX[®]