

AX QuikStart Guide

- INITIAL INSTALLATION INSTRUCTIONS -

Before proceeding with the installation of the AX system, please review these instructions.

1. The complete AX System Installation & Operation Manual is located on the CD included with the CEU.
2. The software program to set up the CEU is located on the CD as well. The CEU must be configured for the system that you are installing in order for the system to function.
3. Included with the CEU is a USB to serial converter, along with a gender changer. This is supplied to allow any PC with a USB port to be used to program the AX CEU.

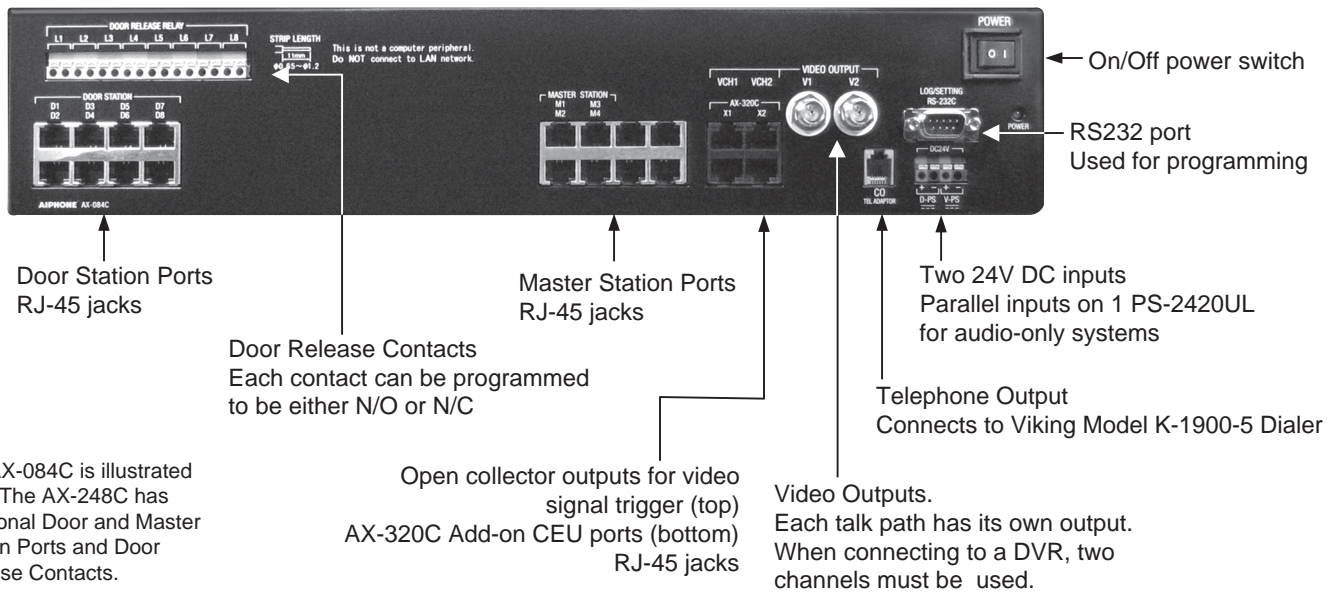

The AX-084C is illustrated here. The AX-248C has additional Door and Master Station Ports and Door Release Contacts.

Connecting Central Exchange Unit to Computer via USB-to-Serial Converter:

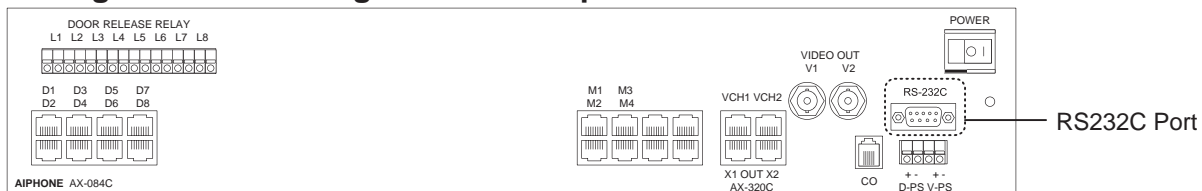

1. Connect power supplies and turn on CEU.
2. If a serial output is not available on your PC: Install the USB driver that comes with the converter onto your PC.
3. Attach the gender changer to the converter and plug converter into the RS232 port on the AX Exchange Unit.
4. Plug the other side of the USB converter into the USB port on the computer.

This will allow you to upload and download program information between the PC and CEU via the AX Setup Tool program.

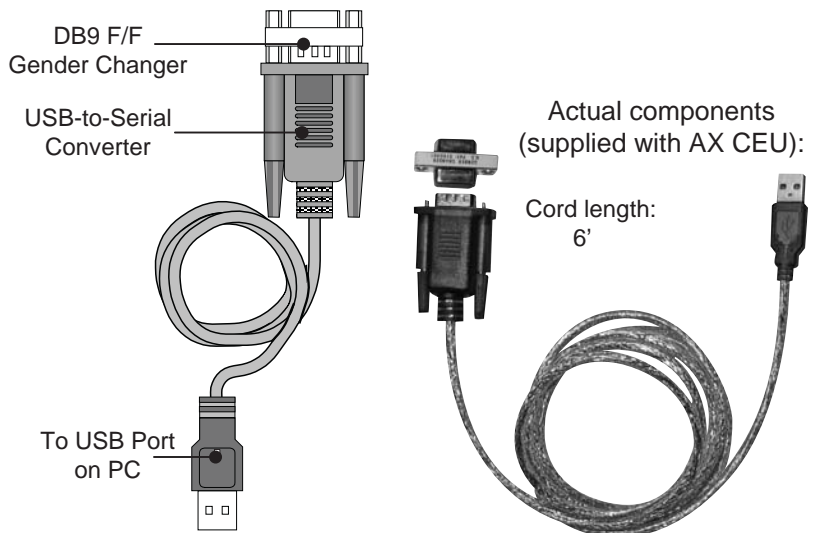

QUICK GUIDE TO CONFIGURING THE AX CENTRAL EXCHANGE UNIT:

The following describes the basics of the AX Setup Tool. Note that the CEU **MUST** be programmed via PC in order for the system to work. Without programming, only Master 1 (M1) and Door 1 (D1) will operate when connected to the CEU.

1) Central Exchange Unit

Step 1: Select the COM Port you will be using. (Based on using existing serial port or USB port with converter. See Page 8 for further information.)

Step 2: Select which model CEU that you are using via the dropdown box.

Step 3: If any AX-320C add-on CEU's are included, click "Connected" for each one.

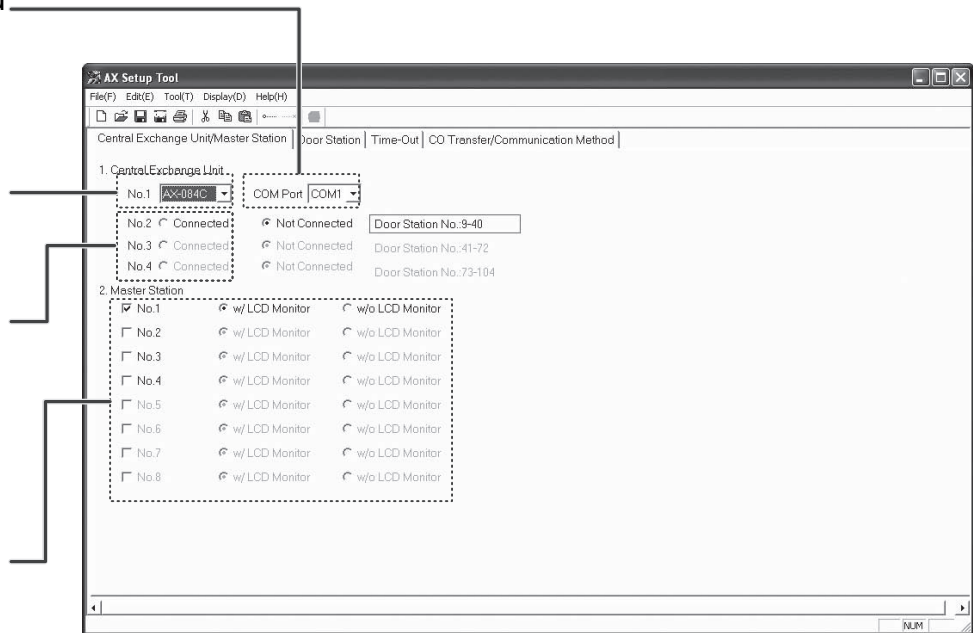

2) Master Station

Step 1: Select the number of masters being used, and whether it is a video master or audio only master.

3) Door Station

Step 1: Fill in location name of each door station if desired. (Not required. Names are not stored in CEU.)

Step 2: Select Video, Audio, or None, depending on which type of door station is connected to each input. (If setting remains on Video when an audio-only door station is used, the AX-8MV's LCD will display a snowy picture when that station is active.)

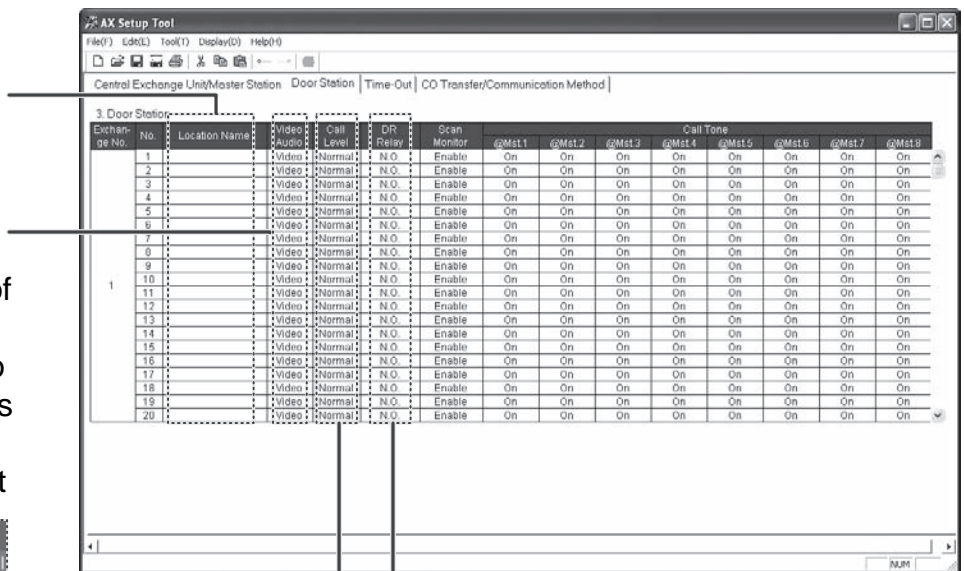
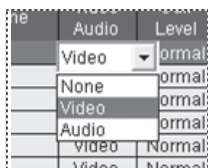

Step 3: Set call priority level by selecting Priority or Normal from the Call Level tab. Priority level calls will have a faster call tone and flashing LED on the master.

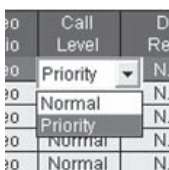

Step 4: Set the door release contact to either Normally Open or Normally Closed by selecting N.O. or N.C. on the DR Relay tab. The default is N.O. (N.O.= Normally Open, N.C. = Normally Closed)

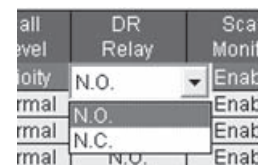

3) Door Station (continued)

Step 5: Enable or disable each station for being eligible for scanning by selecting Enable or Disable from the Scan Monitor Tab.

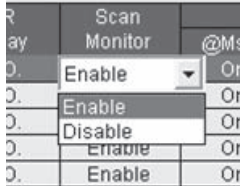

Step 6: Select if you want the door station's call tone to ring on each master station by selecting On or Off from the Call Tone tab. Please note that when set to "Off", the LED and monitor will still come on at the master when the door calls in. Only the call tone will be muted.

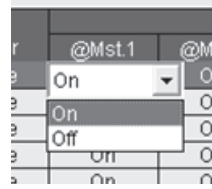
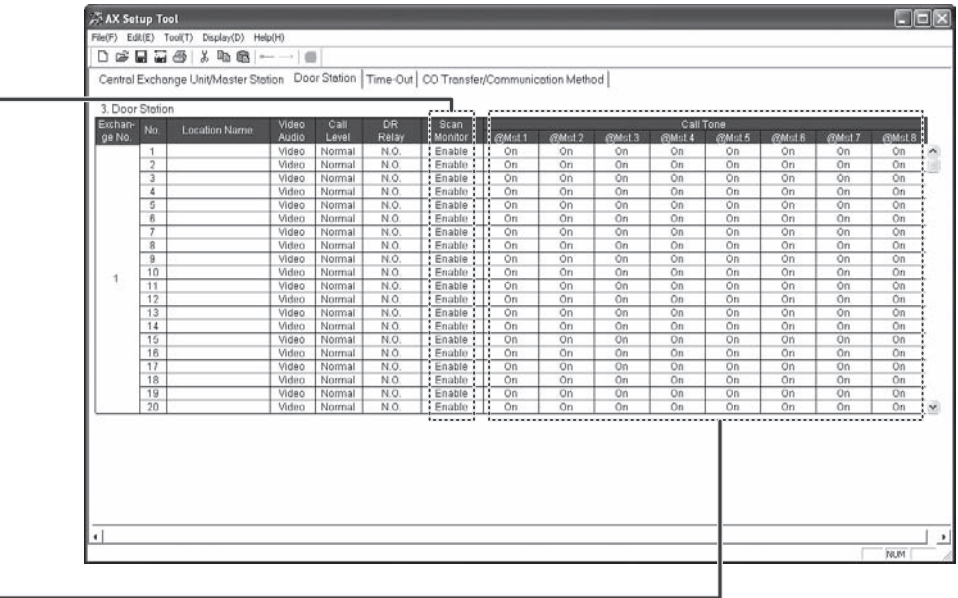

4) Time-Out

Step 1: Set Call-in time for door stations from 10 to 600 seconds, or to infinite if the call is to ring until it is answered. (Set for both Normal and Priority Calls.)

Step 2: Set the duration of an All Call announcement from 10 to 600 seconds. (Set for both Normal and Priority Calls.)

Step 3: Set the CO Transfer time from 10 to 300 seconds for how long a CO transferred call will ring the outside telephone line.

Step 4: Set the Communication time for the maximum amount of time allowed for an intercom conversation (30 to 600 seconds). Set the CO Communication time for the maximum amount of time allowed for a CO transferred call (30 to 600 seconds).

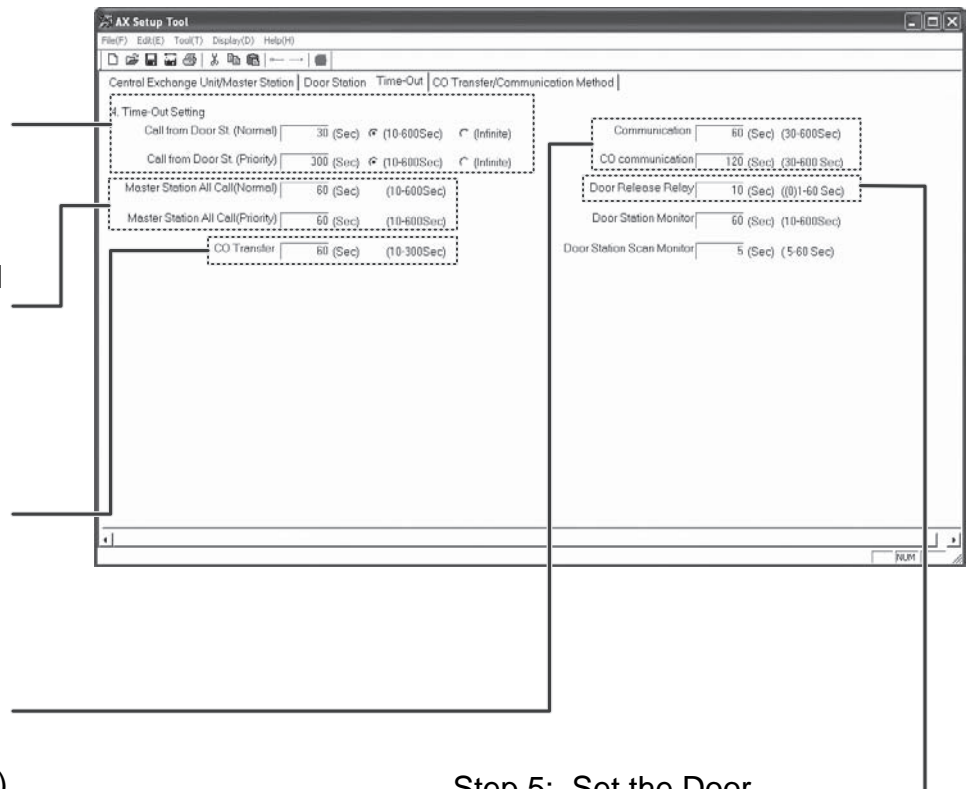

Step 5: Set the Door Release Relay setting for the duration of time that the contacts are to be activated.

4) Time Out (continued)

Step 6: Set the Door Station Monitor for the amount of time that you want to be able to listen in to a door station (10 to 600 seconds). When a door station is selected, the master will be in listen mode for this length of time, then will time out.

Step 7: Set the Door Station Scan Monitor for the amount of time that you want to listen to each door station while in Scan Monitor mode (5 to 60 seconds).

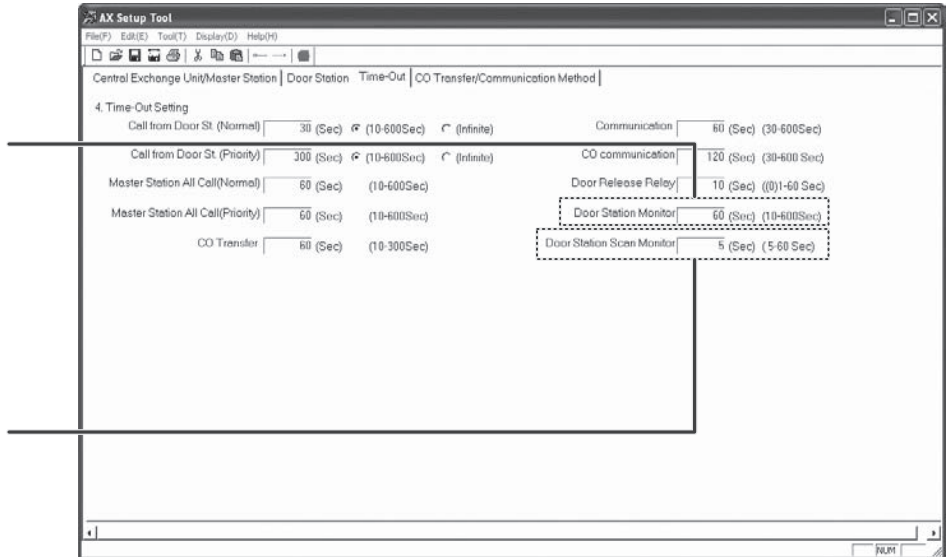

5) CO Transfer

Step 1: If using the CO Transfer feature, click on the Enable button. If not, skip to section 6, Communication Method.

Step 2: If Reverse Polarity Detection is required for your phone line, click on Detect. This is sometimes required, depending on the phone line.

Step 3: The Wait time for Ring-Back-Tone can be adjusted from 1-60 seconds.

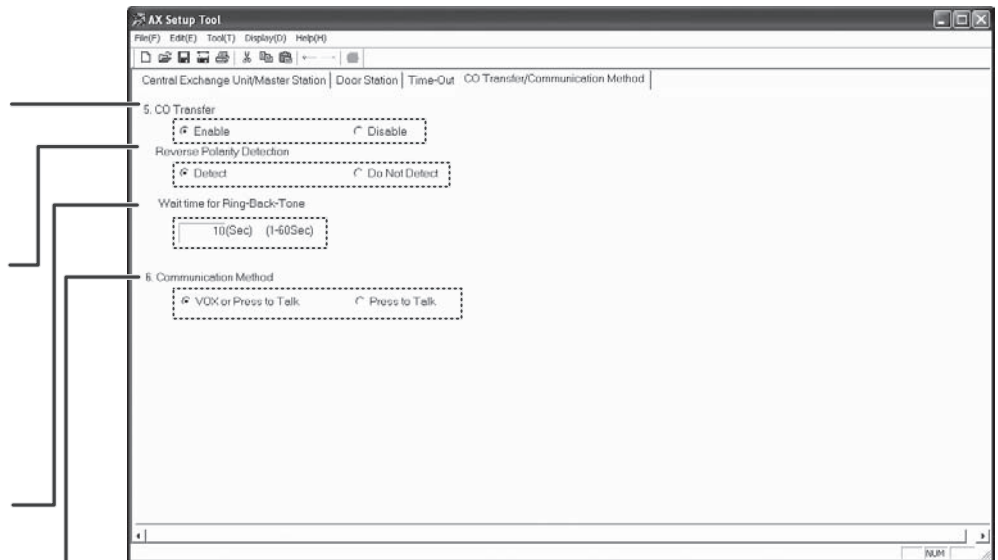

6) Communication Method

Step 1: The Communication Method can be switched from "VOX or Press to Talk" to "Press to Talk only". If "Press to Talk" is selected, hands free VOX feature will be disabled on all master stations.

7) Saving / Uploading

Step 1: Connect PC / Laptop to AX CEU as shown on page 1. Use supplied USB-to-Serial Converter and Gender Changer if a Serial port is not available.

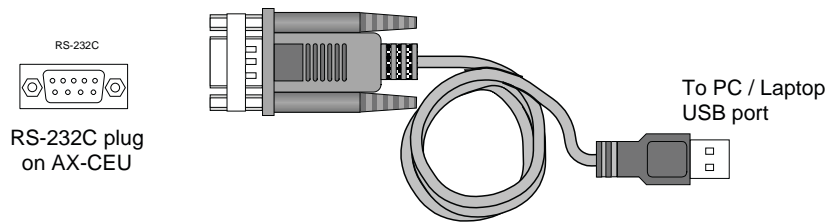

Step 2: Save the settings that you have made by clicking on File, and then Save As. Use the name of the job, or something that describes the job as the file name, so you can refer back to it later.

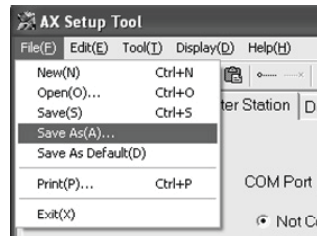

Step 3: Click on Tool, then CEU, then Upload to upload the system settings to the AX CEU.

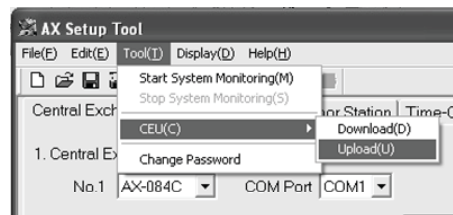

Step 4: Click Yes to the confirmation message asking if you want to overwrite the information in the Central Exchange Unit.



Step 5: Enter the password to authorize the upload. The default password is 9999. Click OK, and the new settings will upload to the CEU.



Step 6: When upload is complete, remove the connector cable from the CEU and save in a secure location. (This will be required when any changes are to be made to the system programming in the future.)

Typical Block Wiring Diagram:

System example includes 8 video door stations and 4 master stations, with selective door release. All master stations and video door stations are wired via CAT-5e cable with RJ-45 jacks at each end. Audio door stations are connected with two conductors at the door station end and an RJ-45 jack at the CEU.

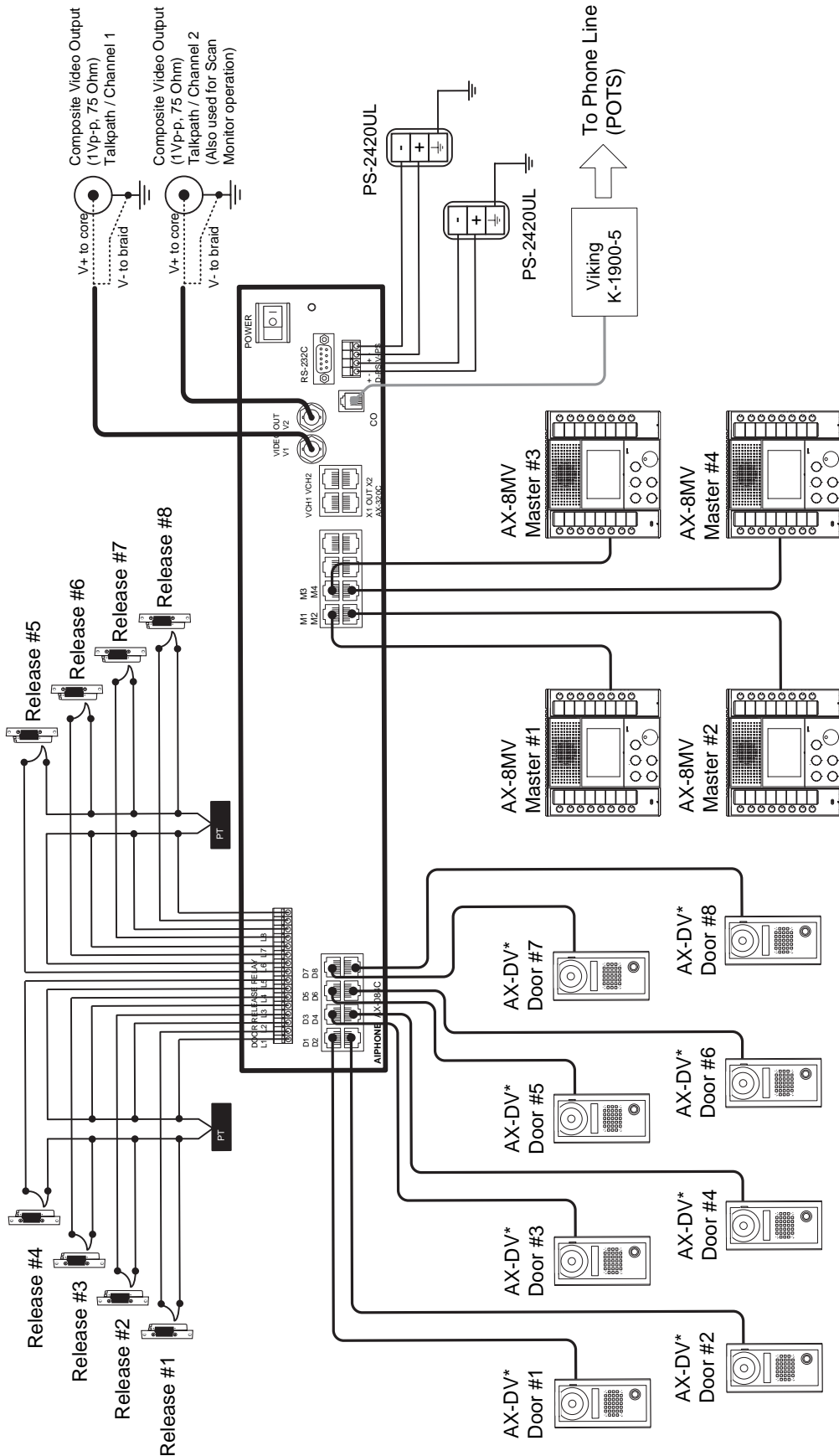

Max. distance from each door station to AX CEU = 980 feet with CAT-5e.
 Max. distance from each master station to AX CEU = 980 feet with CAT-5e.

Wiring (continued):

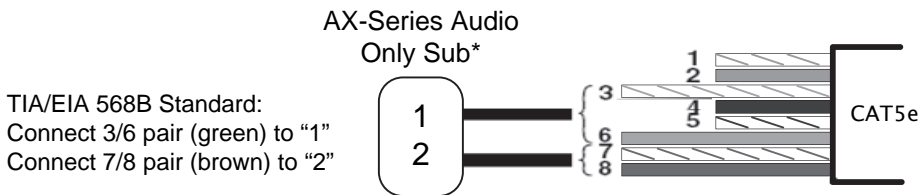

Homerun each sub to
AX-084C, AX-248C, or
AX-320C CEU.

AX-Series sub stations include the following:

AX-DM, AX-A, AX-AN, AX-B, AX-BN, IF-DA, IE-DC, IE-JA, IE-SS,
IE-SSR, and IE-SSV.

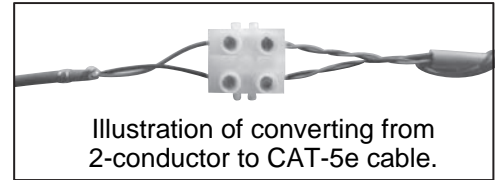

You can use a standard 2-conductor cable when using an audio-only sub station. At the CEU, splice the 2-conductor cable onto a CAT-5e cable with the splicing method of your choice. Install an RJ-45 plug on CEU end of the CAT-5e cable, then simply plug it into the AX Exchange Unit.

RJ-45 connectors for the door station ports are located on the left side of the exchange. Please note that the odd numbers are located on top, and the even numbers are located on the bottom. The master ports are in the center of the CEU, with the odd numbers on top and even numbers on the bottom.

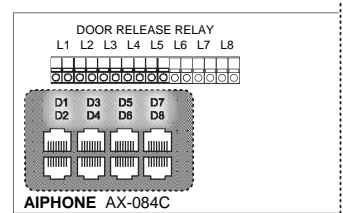

The Door Release Contacts can be individually programmed to be either N/O or N/C. The contacts are located above the door station ports. "L1" are the contacts* for door station port "D1", "L2" are the contacts for "D2", etc. As the "L#" connections are dry contacts, a separate power source is required for the actual door strikes or magnetic locks.

***Note the dry contact rating: 24V AC/DC, 500mA.**

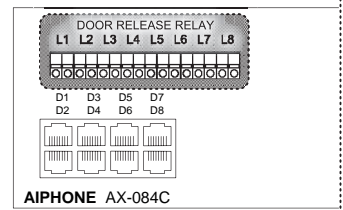

The AX-084C and AX-248C units have a built-in composite video output, one per talkpath. When tying to a recording device such as a DVR, connect each output to separate inputs on the DVR. Each output also has a corresponding trigger, via a normally open collector labeled VCH1 and VCH2. Pin 4 is the trigger and pin 5 is the ground. Please note that the video signal is only present when a video door station is active and there is an image on the AX-8MV's monitor.

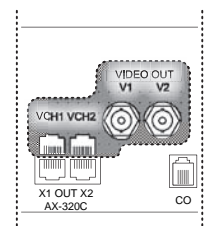

The AX-084C and AX-248C both have the ability to connect to the AX-320C. Connect outputs X1 and X2 with two CAT-5e cables. Both X1 and X2 must be connected. The AX-320C must be within 33 feet of the main CEU.

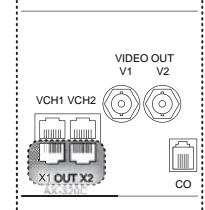

The AX-084C and AX-248C are powered by two PS-2420UL power supplies. One power supply can be used for an audio-only system. When using one power supply, jumper the two + terminals together and connect to + of power supply. Jumper two negative's together and connect to - of power supply. Power for AX-320C add-on CEU's comes from the system power supplies. Parallel connect power wires to all AX-320C's in the system.

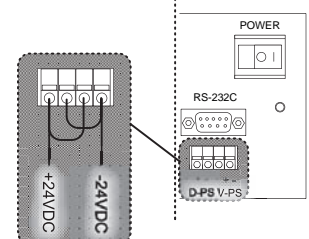

Labeling the Master Station's Directory Cards

Aiphone provides a template for creating professionally printed directory cards for the AX series master stations.

The template is located on the CD included with the CEU.

View CD contents using My Computer or Windows Explorer.

- Open file folder called "DirectoryCard"
- Open PDF document "AX-8MV_DirectoryLetter"
- Type in location names of master and door stations.
- Print and cut strips to fit in directory slots on master stations (replacing blank paper strips included with the master). Replace plastic directory cover.

Example: Directory cards when using template:

Master Stations	Door Stations
FRONT OFFICE	FRONT DOOR
S&H OFFICE	EMP. ENTRANCE
EMPL. LOUNGE	DELIVERY DOOR
SECURITY DESK	ELEVATOR LOBBY

Determining the Appropriate COM Port

If you are utilizing the provided USB-to-Serial converter or have a computer with more than one serial port, you will need to identify the port you are connecting to prior to selection inside the AX Setup Utility. Ensure that the driver for the USB-to-Serial converter is installed (supplied on mini-CD); otherwise the device may not be shown on the Device Manager.

To determine the COM ports on your computer, right-click on 'My Computer' either on the Windows desktop or the Start menu and select 'Properties'. When the Properties window appears, select the 'Hardware' tab and click the button labeled 'Device Manager.'

With the Device Manager open, scroll down to 'Ports (COM & LPT).' The Aiphone-supplied USB-to-Serial converter will be shown as "Prolific USB-to-Serial Comm Port (COMX);" the number where the 'X' indicates the COM port number to be chosen in the AX Setup Utility. Note that the AX Setup Utility will only recognize COM ports numbered from COM1 to COM9. If the default COM port is outside of that range, reassign COM port numbers using the advanced settings tab under the COM port properties.

