

**IABU Headquarters****Delta Electronics, Inc.****Taoyuan**

31-1, Xingbang Road, Guishan Industrial Zone,
Taoyuan County 33370, Taiwan, R.O.C.
TEL: 886-3-362-6301 / FAX: 886-3-362-7267

Asia**Delta Electronics (Jiang Su) Ltd.****Wujiang Plant3**

1688 Jiangxing East Road,
Wujiang Economy Development Zone,
Wujiang City, Jiang Su Province,
People's Republic of China (Post code: 215200)
TEL: 86-512-6340-3008 / FAX: 86-512-6340-7290

Delta Greentech (China) Co., Ltd.

238 Min-Xia Road, Cao-Lu Industry Zone, Pudong, Shanghai,
People's Republic of China
Post code : 201209
TEL: 021-58635678 / FAX: 021-58630003

Delta Electronics (Japan), Inc.**Tokyo Office**

Delta Shibadaimon Building, 2-1-14
Shibadaimon, Minato-Ku, Tokyo, 105-0012,
Japan
TEL: 81-3-5733-1111 / FAX: 81-3-5733-1211

Delta Electronics (Korea), Inc.

234-9, Duck Soo Building 7F, Nonhyun-Dong,
Kangnam-Gu, Seoul, Korea 135-010
TEL: 82-2-515-5305 / FAX: 82-2-515-5302

Delta Electronics (Singapore) Pte. Ltd.

8 Kaki Bukit Road 2, #04-18 Ruby Warehouse Complex,
Singapore 417841
TEL: 65-6747-5155 / FAX: 65-6744-9228

Delta Power Solutions (India) Pte. Ltd.

Plot No. 28, Sector-34, EHTP
Gurgaon-122001 Haryana, India
TEL: 91-124-416-9040 / FAX: 91-124-403-6045

America**Delta Products Corporation (USA)****Raleigh Office**

P.O. Box 12173, 5101 Davis Drive,
Research Triangle Park, NC 27709, U.S.A.
TEL: 1-919-767-3813 / FAX: 1-919-767-3969

Delta Greentech (Brasil) S/A**Sao Paulo Office**

Rua Itapeva, N° 26, 3° andar, Bela vista
ZIP: 01332-000 - São Paulo - SP - Brasil
TEL : 55-11-3568-3875 / FAX : 55-11-3568-3865

Europe**Deltronics (The Netherlands) B.V.****Eindhoven Office**

De Witbogt 15, 5652 AG Eindhoven, The Netherlands
TEL: 31-40-2592850 / FAX: 31-40-2592851

*We reserve the right to change the information in this catalogue without prior notice



VFD-E

High Performance / Flexible Extension /
Micro Type AC Motor Drive



VFD-E



VFD-E

Features

• Modular Design

Modular structure and extension with optional cards

• Standard MODBUS Protocol

Standard MODBUS Protocol via RS-485

• Built-in EMI Filter (230V 1-phase and 460V 3-phase)

To reduce electromagnetic interference efficiently

• Compact Design

Space saving and easy DIN rail mounting with optional DIN rail adapter

• Optional Fieldbus Modules

Provide connection to a variety of networks, including Profibus, DeviceNet, LonWorks and CANopen

• Flexible Extension

Via optional cards, such as I/O card, Relay card, PG (Encoder) card and USB card, to meet your application requirements



• RFI-Switch for IT Mains

Removable "Y" capacitor to use with IT mains supplies.



• Easy DC BUS Sharing

Multiple VFD-E can be connected in parallel to share the regenerative braking energy. In this way, over-voltage is prevented and the DC-bus voltage stabilized.

• Complete Protection Function

High precision current detection, full overload protection (oL, oL1 and oL2), over-voltage/over-current stall prevention, short-circuit protection, reset after fault, speed search function and motor overheat protection by PTC.

• Removable Keypad

The standard keypad acts as status monitor. More functions, including parameter modification, RUN/STOP, speed change, and status display, via optional keypad



• Power Range

- 1-phase 115V series: 0.2~0.75kW (0.25~1hp)
- 1-phase 230V series: 0.2~2.2kW (0.25~3hp)
- 3-phase 230V series: 0.2~7.5kW (0.25~20hp)
- 3-phase 460V series: 0.4~22kW (0.50~30hp)

• Built-in PLC Function

Easy to write PLC program without additional PLC

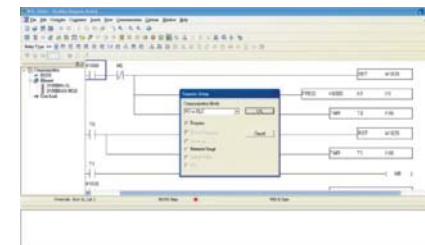

• Side-by-side Installation(40°C)

High-efficiency cooling and flexible space



• Easy Maintenance

Removable cooling fan for easy maintenance



Application Cases

• Vacuum compressor

It reduces the large load of instant vacuum with VFD-E outstanding overload capacity.



• Escalator

It not only saves energy with built-in PLC function and multi-step speed but also eliminates cost of external controller.





Standard Wiring Diagram

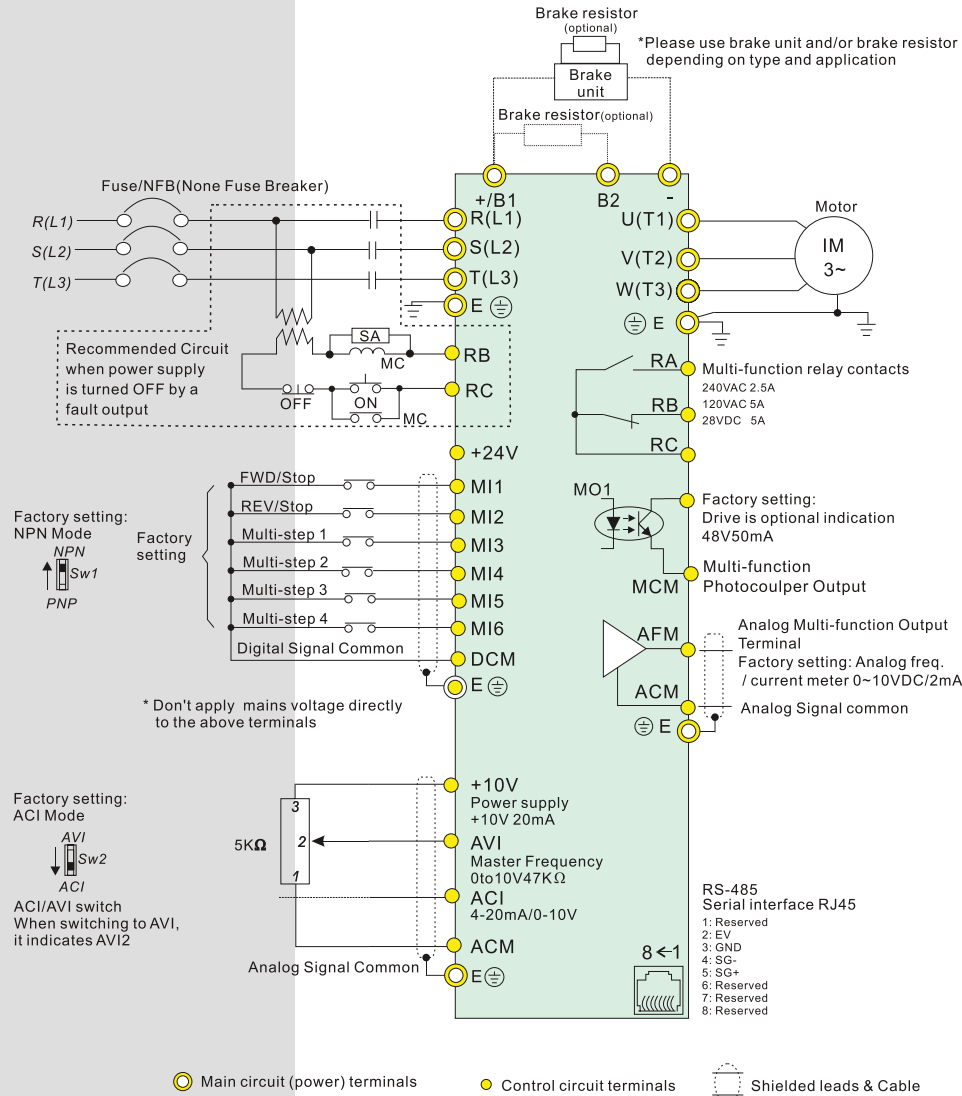

External Parts

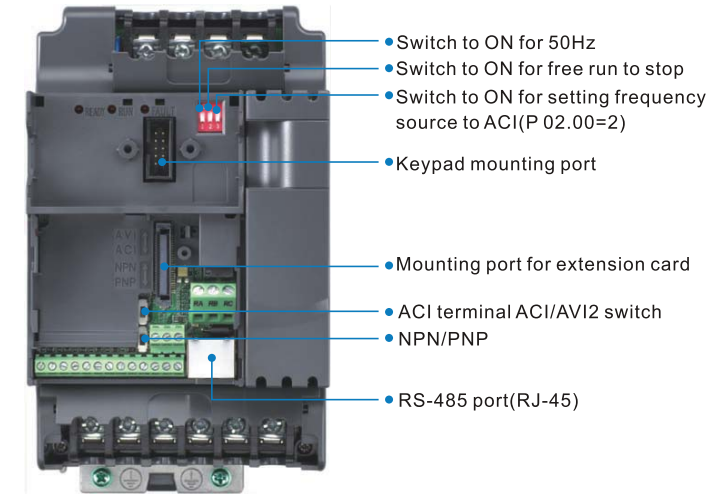

Control Terminals

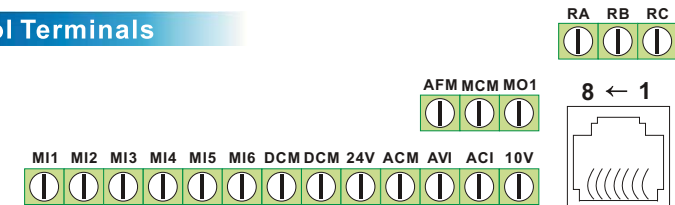

Model Explanation

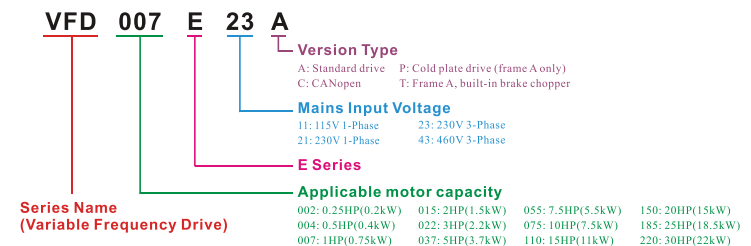



Application Fields

Conveyor and Transportation Machinery

- Conveyor belt
- Escalator
- Automatic doors
- Parking device
- Roller door
- Small elevator
- X-Y axis of traveling crane

Food Processing

- Dumpling maker
- Food stirrer
- Noodle maker

Machine Tool/Metal Processing Machinery

- Grinder
- Drill
- Small lathe
- Milling machines
- Injection molding (clamp)

Wood Working Machinery

- 4 side planer
- Wood carver
- Wood working machine
- Simple cutting machine for wood working
- Spraying machine

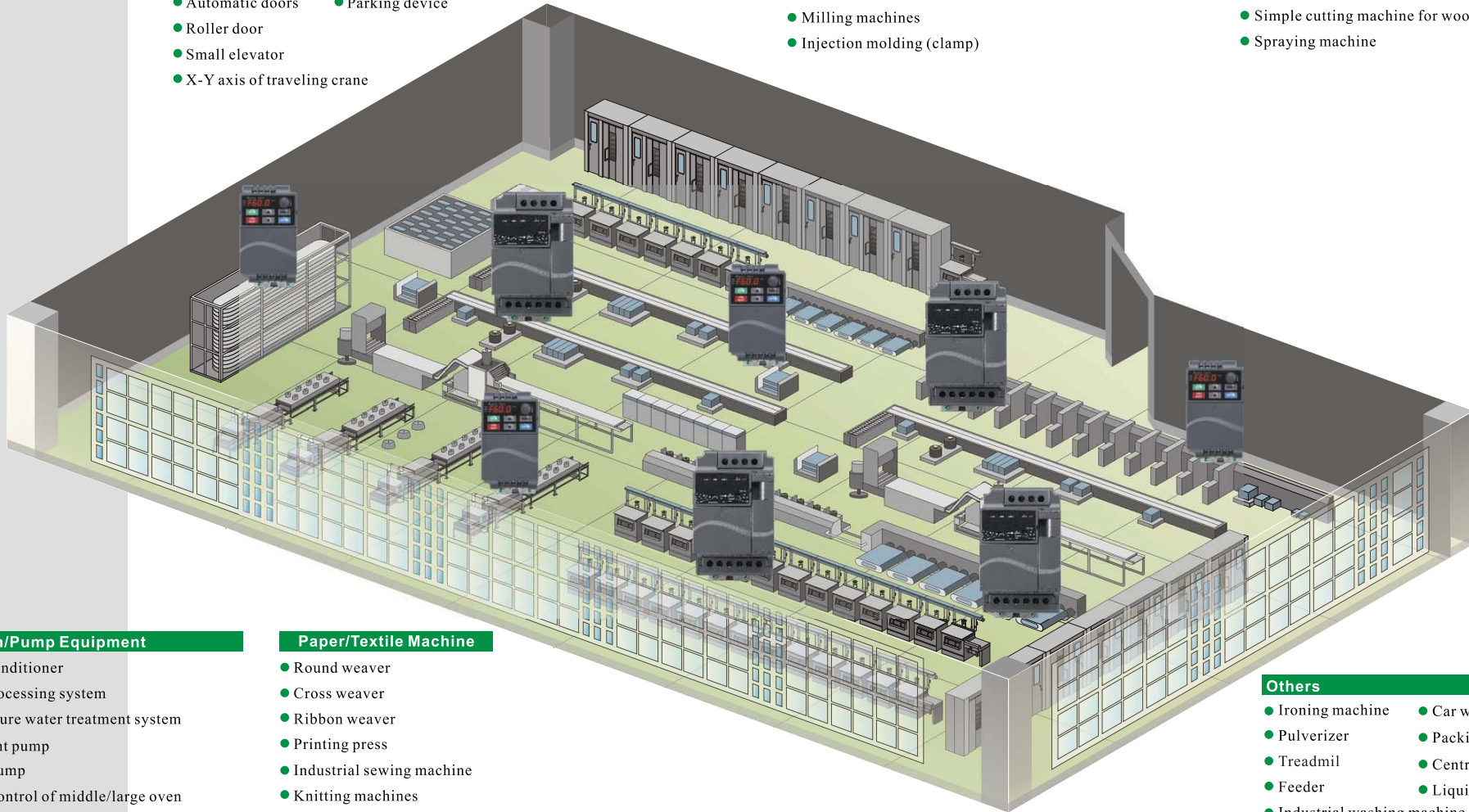

Fan/Pump Equipment

- Building air conditioner
- Wastewater processing system
- Constant pressure water treatment system
- Water treatment pump
- Agricultural pump
- Temperature control of middle/large oven
- Air compressor
- Heat exchange fans
- Building water dispenser system

Paper/Textile Machine

- Round weaver
- Cross weaver
- Ribbon weaver
- Printing press
- Industrial sewing machine
- Knitting machines

Others

- Ironing machine
- Car washing machine
- Pulverizer
- Packing machine
- Treadmil
- Centrifuge
- Feeder
- Liquid mixer
- Industrial washing machine



Specifications

Voltage Class	115V		
Model Number VFD-___ E	002	004	007
Max. Applicable Motor Output (kW)	0.2	0.4	0.75
Max. Applicable Motor Output (hp)	0.25	0.5	1.0
Rated Output Capacity (kVA)	0.6	1.0	1.6
Rated Output Current (A)	1.6	2.5	4.2
Maximum Output Voltage (V)	3-phase proportional to twice the input voltage		
Output Frequency (Hz)	0.1~600Hz		
Carrier Frequency (kHz)	1-15		
Rated Input Current (A)	Single-phase		
	6	9	18
Rated Voltage/Frequency	Single phase 100-120V, 50/60Hz		
Voltage Tolerance	± 10%(90-132V)		
Frequency Tolerance	± 5%(47-63Hz)		
Cooling Method	Natural Cooling		Fan Cooling
Weight (kg)	1.2	1.2	1.2

Voltage Class	230V									
Model Number VFD-___ E	002	004	007	015	022	037	055	075	110	150
Max. Applicable Motor Output (kW)	0.2	0.4	0.75	1.5	2.2	3.7	5.5	7.5	11	15
Max. Applicable Motor Output (hp)	0.25	0.5	1.0	2.0	3.0	5.0	7.5	10.0	15	20
Rated Output Capacity (kVA)	0.6	1.0	1.6	2.9	4.2	6.5	9.5	12.5	17.1	25
Rated Output Current (A)	1.6	2.5	4.2	7.5	11.0	17	25	33	45	65
Maximum Output Voltage (V)	3-phase proportional to input voltage									
Output Frequency (Hz)	0.1~600Hz									
Carrier Frequency (kHz)	1-15									
Rated Input Current (A)	Single/3-phase					3-phase				
	4.9/1.9	6.5/2.7	9.7/5.1	15.7/9	24/15	20.6	26	34	48	70
Rated Voltage/Frequency	Single/3-phase, 200-240V, 50/60Hz					3-phase, 200-240V, 50/60Hz				
Voltage Tolerance	± 10%(180-264V)									
Frequency Tolerance	± 5%(47-63Hz)									
Cooling Method	Natural Cooling					Fan Cooling				
Weight (kg)	1.1	1.1	1.1	1.9	1.9	1.9	3.5	3.5	3.57	6.6

Voltage Class	460V											
Model Number VFD-___ E	004	007	015	022	037	055	075	110	150	185	220	
Max. Applicable Motor Output (kW)	0.4	0.75	1.5	2.2	3.7	5.5	7.5	11.0	15	18.5	22	
Max. Applicable Motor Output (hp)	0.5	1.0	2.0	3.0	5.0	7.5	10.0	15.0	20	25	30	
Rated Output Capacity (kVA)	1.2	2.0	3.3	4.4	6.8	9.9	13.7	18.3	24	29	34	
Rated Output Current (A)	1.5	2.5	4.2	5.5	8.5	13.0	18.0	24.0	32	38	45	
Maximum Output Voltage (V)	3-phase proportional to input voltage											
Output Frequency (Hz)	0.1~600Hz											
Carrier Frequency (kHz)	1-15											
Rated Input Current (A)	3-phase											
	1.9	3.2	4.3	7.1	11.2	14	19	26	35	41	49	
Rated Voltage/Frequency	3-phase, 380-480V, 50/60Hz											
Voltage Tolerance	± 10%(342-528V)											
Frequency Tolerance	± 5%(47-63Hz)											
Cooling Method	Natural Cooling						Fan Cooling					
Weight (kg)	1.2	1.2	1.2	1.9	1.9	4.2	4.2	4.2	7.47	7.47	7.47	

Control Characteristics	Control System	SPWM (Sinusoidal Pulse Width Modulation) Control (V/f or sensorless vector control)	
	Frequency Setting Resolution	0.01Hz	
	Output Frequency Resolution	0.01Hz	
	Torque Characteristics	Including the auto-torque/auto-slip compensation; starting torque can be 150% at 3.0Hz	
	Overload Endurance	150% of rated current for 1 minute	
	Skip Frequency	Three zones, setting range 0.1~600Hz	
	Accel/Decel Time	0.1 to 600 seconds (2 Independent setting of Accel/Decel time)	
	Stall Prevention Level	Setting 20 to 250% of rated current	
	DC Braking	Operation frequency 0.1~600.0Hz, output 0~100% rated current Start time 0~60 seconds, stop time 0~60 seconds	
	Regenerated Braking Torque	Approx. 20% (up to 125% possible with optional brake resistor or externally mounted brake unit, 1-15hp models (built-in brake chopper))	
Operating Characteristics	V/f Pattern	Adjustable V/f pattern	
	Frequency Setting	Keypad	Setting by ▲▼
		External Signal	Potentiometer-5kΩ/0.5W, 0 to +10VDC, 4 to 20mA, RS-485 interface; Multi-function Inputs 3 to 9 (15 steps, Jog, up/down)
	Operation Setting Signal	Keypad	Set by RUN and STOP
		External Signal	2 wires/3 wires (FWD, REV, EF), JOG operation, RS-485 serial interface (MODBUS), programmable logic controller
	Multi-function Input Signal	Multi-step selection 0 to 15, Jog, accel/decel inhibit, 2 accel/decel switches, counter, external Base Block (NC, NO), auxiliary motor control is invalid, ACI/AVI/AUI selections, driver reset, UP/DOWN key settings, sink/source (=NPN/PNP) selection	
	Multi-function Output Indication	AC drive operating, frequency attained, non-zero frequency, Base Block, fault indication, local/remote indication, auxiliary motor output, drive is ready, overheat alarm, emergency stop and status selections of input terminals (NC/NO)	
	Analog Output Signal	Output frequency/current	
	Alarm Output Contact	Contact will be On when drive malfunctions (1 Form C/change-over contact or 1 open collector output)	
	Operation Functions	Built-in PLC, AVR, accel/decel S-Curve, over-voltage/over-current stall prevention, 5 fault records, reverse inhibition, momentary power loss restart, DC braking, auto torque/slip compensation, auto tuning, adjustable carrier frequency, output frequency limits, parameter lock/reset, vector control, PID control, external counter, MODBUS communication, abnormal reset, abnormal re-start, power-saving, sleep/wake function, fan control, 1st/2nd frequency source selections, 1st/2nd frequency source combination, NPN/PNP selection	
Protection Functions	Over voltage, over current, under voltage, under current, external fault, overload, ground fault, overheating, electronic thermal, IGBT short circuit, PTC		
Display Keypad	6-key, 7-segment LED with 4-digit, 5 status LED, master frequency, output frequency, output current, custom units, parameter values for setup and lock, faults, RUN, STOP, RESET, FWD/REV		
Environmental Conditions	Built-in EMI Filter	For 230V 1-phase and 460V 3-phase models	
	Enclosure Rating	IP20	
	Pollution Degree	2	
	Installation Location	Altitude 1,000m or lower, keep from corrosive gasses, liquid and dust	
	Ambient Temperature	-10°C to + 50°C (40°C for side-by-side mounting) Non-Condensing and not frozen	
	Storage/Transportation Temperature	-20°C to 60°C	
	Ambient Humidity	Below 90% RH (non-condensing)	
Vibration	9.80665m/s ² (1G) less than 20Hz, 5.88m/s ² (0.6G) at 20 to 50Hz		
Approvals	  		



Dimensions

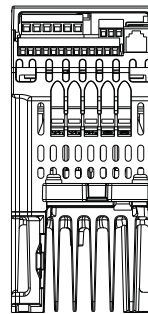
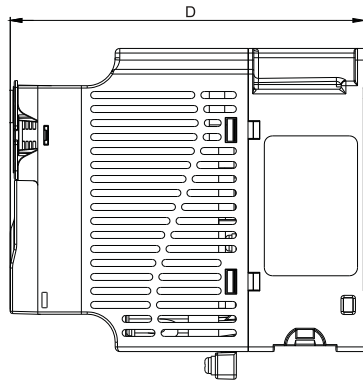
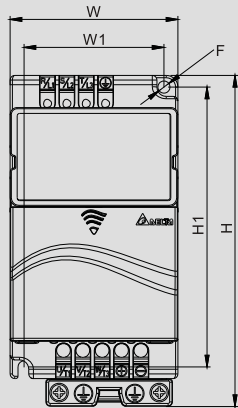

Unit: mm(inch)

Model	W	W1	H	H1	D	F
VFD002E11A/11/11C						
VFD002E21A/21T/21C						
VFD002E23A/23T/23C						
VFD004E11A/11T/11C	72.0 (2.83)	60.0 (2.36)	142.0 (5.59)	120.0 (4.72)	152.0 (5.98)	5.2 (0.20)
VFD004E21A/21T/21C						
VFD004E23A/23T/23C						
VFD004E43A/43T/43C						
VFD007E11A/11C						
VFD015E21A/21C						
VFD022E21A/21C	100.0 (3.94)	89.0 (3.51)	174.0 (6.86)	162.0 (6.38)	152.0 (5.98)	5.5 (0.22)
VFD022E23A/23C						
VFD022E43A/43C						
VFD055E23A/23C						
VFD055E43A/43C	130.0 (5.12)	116.0 (4.57)	260.0 (10.24)	246.5 (9.71)	169.2 (6.67)	5.5 (0.22)
VFD075E23A/23C						
VFD150E23A/23C						
VFD150E43A/43C	200.0 (7.87)	180.0 (7.09)	310.0 (12.20)	290.0 (11.42)	190.0 (7.48)	10.0 (0.39)
VFD002E11P						
VFD002E21P						
VFD002E23P						
VFD004E11P	72.0 (2.83)	56.0 (2.20)	155.0 (6.10)	143.0 (5.63)	111.5 (4.39)	5.3 (0.21)
VFD004E21P						
VFD004E23P						
VFD004E43P						

New Models

- VFD-E-T : Built-in brake chopper for frame A
- VFD-E-P : Plate drive
- VFD-E-C : Built-in CANopen communication

Accessories

Optional Cards



EME-R3AA
Relay card (3 form A/
NO contacts)



EME-R2CA
Relay card (2 form C/
Change-over contacts)



EME-33A
I/O card
(photocoupler 3in+3out)



EME-A22A
Anglog I/O Card (12 bits)



EME-PG01
PG card



CME-USB01
Second communication card
(USB1.1)

Fieldbus Modules



DeviceNet



Profibus



LonWorks



CANopen

Others



Digital keypad



Brake resistor

- Keypad for communication (VFD-PU06)
- Zero phase reactor
- Keypad cable
- DIN rail(Width35mm)
- EMI input filter
- Grounding plate
- Brake unit
- DC fan
- AC reactor