

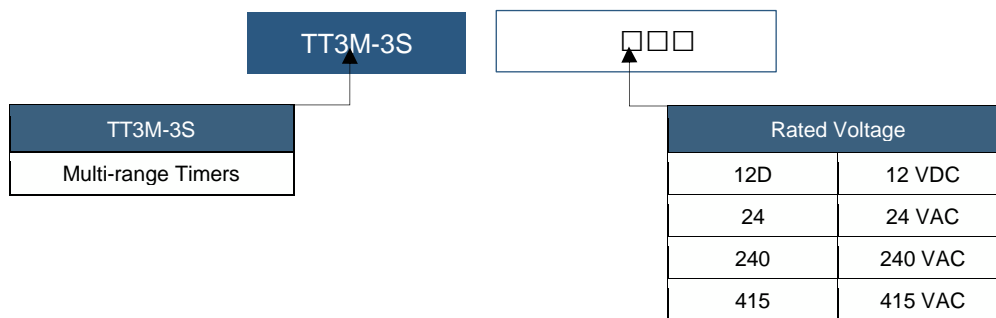

TT3M-3S24

Economy Multi-Range Timers

- Range of Operating Voltages Available
- Use Micro-controller to ensure accuracy of different time range.
- 16 different time ranges available, from 3 seconds to 60 hours
- 1 of 2 dry contacts is user-selectable.



Properties

Properties		
Manufacturer	Eureka	
Product Range	TT3M Economy Multi Range Timers	
Time Range	Seconds:	3 / 6 / 30 / 60
	Minutes:	3 / 6 / 30 / 60
	Hours:	3 / 6 / 30 / 60
Rated Supply Voltage	DC	12 V
	AC	24, 240, 415 V
Operating Voltage Range	85% to 110% of rated supply voltage	
Rated Frequency	50 / 60Hz	
Contact Rating	250 VAC 5A Resistive Load	
Reset Time	Less than 0.1 seconds	
Power Consumption	Approximately 2 VA (1.6W)	
Endurance	Mechanical	5000000 Operations
	Electrical	100000 Operations
Pin Configuration	8 pins	
Ambient Temperature	-10°C~+50°C	
Ambient Humidity	Maximum- 85% RH	
Available Modes	Mode A	1A1C
	Mode B	2C
Accessories	US-08; Round 8 Pin Base	
	P2CF-08; Round 8 Pin Base with Clips	
	P3G-08; 8 Pin Base Back Wired	

Wiring Diagram

Mode A; 1A1C

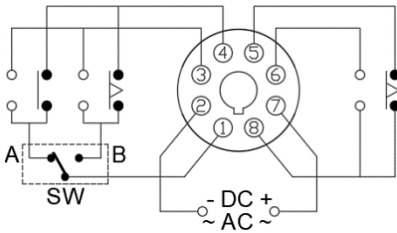

Mode B; 2C

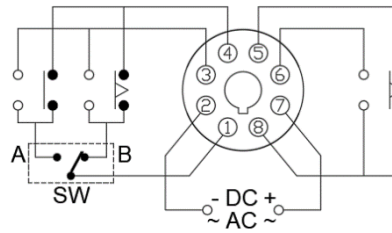

Time Chart

Mode A: 1A1C

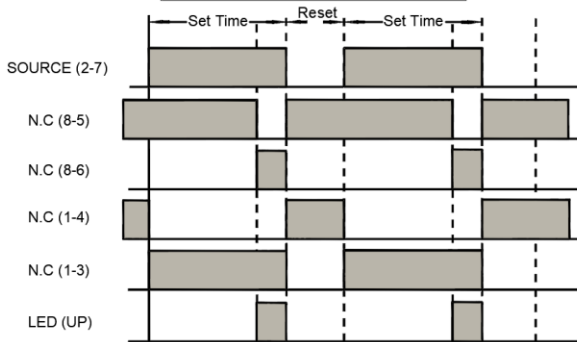

Mode B: 2C

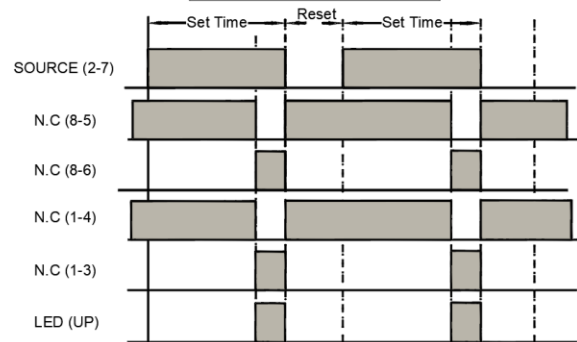

Dimension for TTM3-3S□□□

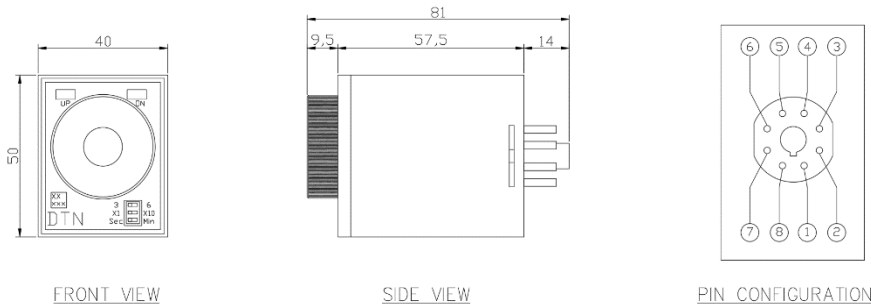

Dimension for PF085 (comes with the timer)

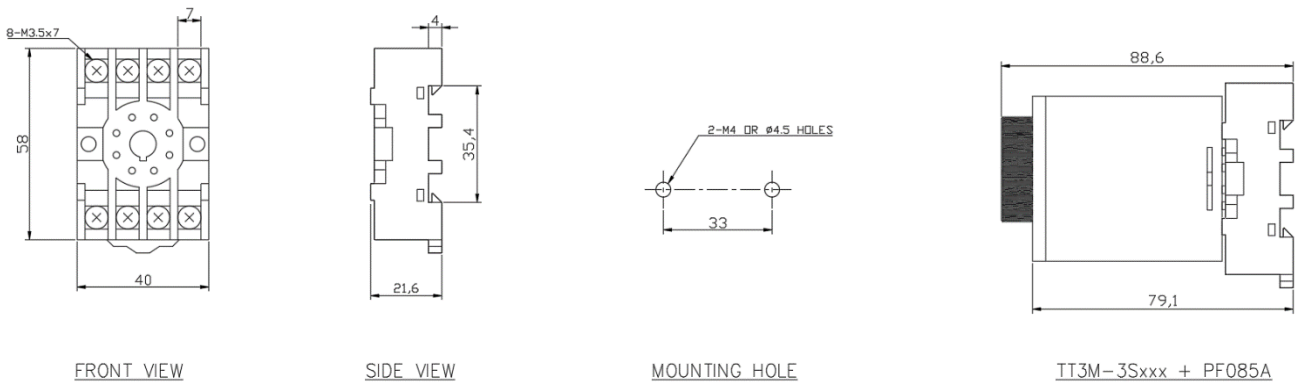

Dimension for US-08

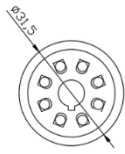

FRONT VIEW

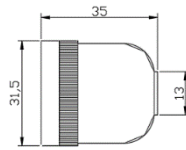

SIDE VIEW

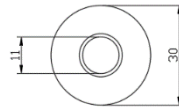

REAR VIEW

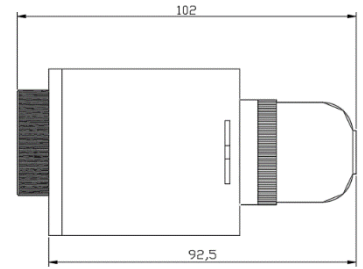

TT3M-3Sxxx + US-08

Dimension for P3G-08

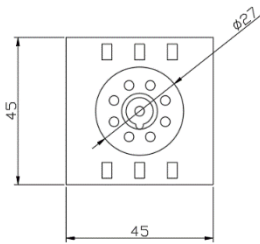

FRONT VIEW

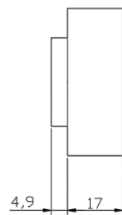

SIDE VIEW

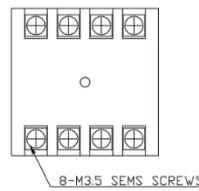

REAR VIEW

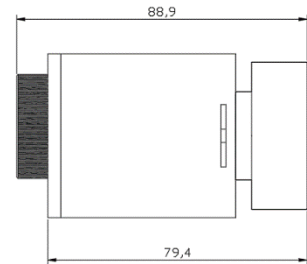

TT3M-3Sxxx + P3G-08

Dimension for P2CF-08

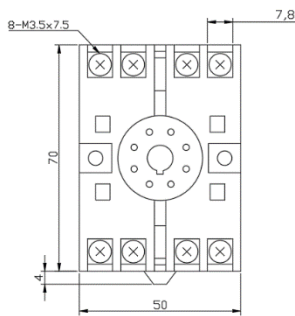

FRONT VIEW

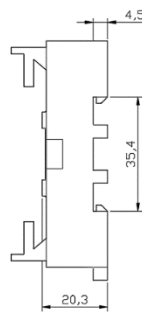

SIDE VIEW

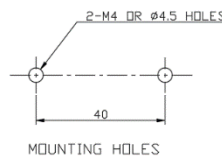

MOUNTING HOLE

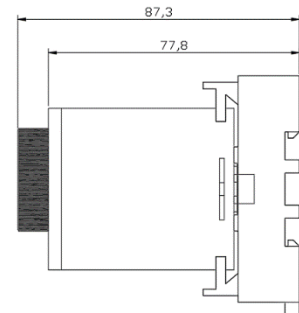

TT3M-3Sxxx + P2CF-08