

Reliable Protection for  
systems, generators and  
motors up to 1600 A



Product Information  
Circuit-Breakers NZM, Switch-Disconnectors PN/N



Powering Business Worldwide



*Powering Business Worldwide*



1-pole

3-pole circuit-breaker

4-pole circuit-breaker



## The new range up to 1600 A – New ideas for better circuit-breakers

The new Eaton circuit-breakers cover a range from 15 to 1600 A with just four frame sizes. And they are optimally matched to one another. The wide application spectrum covers every requirement as Eaton has closely examined what every customer needs and implemented the appropriate solutions. Outstanding, for example, is the continuous switching power range – which extends from the smallest to the largest circuit-breaker or the modular system which can be matched without difficulty to suit the specific application. Thus, the circuit-breakers can be used universally – from the smallest of service distribution boards, to machine controls or motor starter combinations, up to large energy distribution systems with a short-circuit breaking capacity of up to 150 kA.

### Circuit-breakers for use all over the world

All circuit-breakers fulfil the demands for world-wide use. This applies for the United States, Canada and the Chinese markets with the certification to UL, CSA and CCC (China Compulsory Certification).

In conjunction with the shipping classification authorities, Eaton also conducts testing in order to obtain the following certification: Lloyds Register of Shipping, Bureau Veritas, Det Norske Veritas, Polski Rejestr Statkow.

### Full performance up to 50 °C

All circuit-breakers and switch-disconnector's are designed to facilitate operation up to an ambient temperature of 50 °C under full load conditions without need to reduce the rated current (derate). This is a comfortable prerequisite for simple and practice relevant engineering with important safety components.

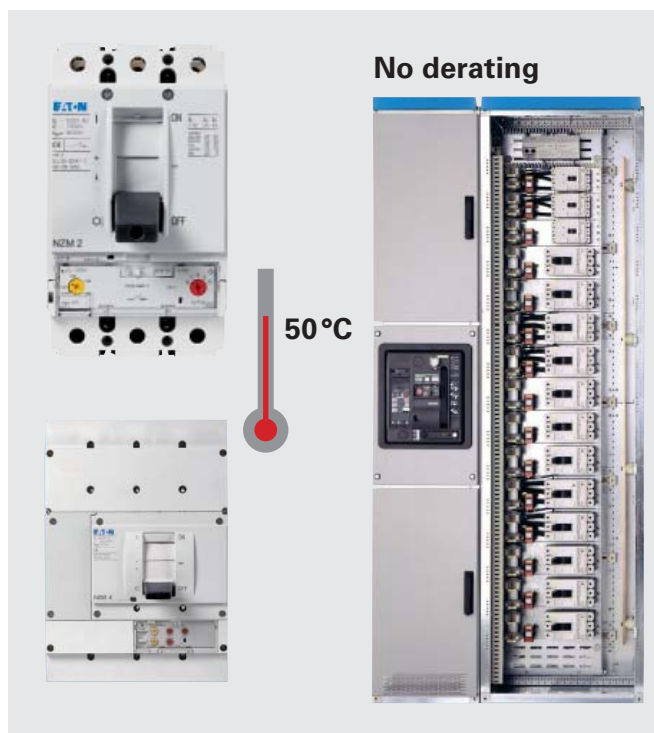

Circuit-breaker		NZM1	NZM2	NZM3	NZM4
Short-circuit breaking capacity	18 kA				
$I_{cu}$ to IEC/EN 60947 at 415 V 3/4-pole 230V 1-pol	25 kA				
	36 kA				
	50 kA				
	100 kA				
	150 kA				
Application range in A		16-125	15 – 300	125 – 630	315 – 1600
Nuber of poles		1	3/4	3/4	3/4
Rated voltage in V		230	690	690	690
Circuit-breakers for North America		NZM1-NA	NZM2-NA	NZM3-NA	NZM4-NA
Short-circuit breaking capacity	25 kA				
$I_{cu}$ to UL489 at 480 V	35/42 kA				
	85/100 kA				
Short-circuit breaking capacity	18 kA				
$I_{cu}$ to CSA 22.2 No 5.1 at 600 V	25/35 kA				
	50 kA				
Application range in A		1.2 – 125	1.6 – 250	125 – 600	400 – 1200
Nuber of poles		3	3	3	3
Rated voltage in V		480	600	600	600
Dimensions in mm	Width 3/4-polig	90/120	105/140	140/185	210/280
	Height	145	184	275	401
	Depth	68	103	120.5	138

### More power on the smallest space: NZM1 up to 160 A, NZM2 up to 300 A

Space in the control panel – and accordingly the costs – can be easily saved with the circuit-breakers NZM1 and NZM2. Instead of using the next larger size, now simply use the more compact further development from the NZM system series.

Two advantages at once:  
same performance with up to 25% reduced space requirement and up to 20% cost savings.

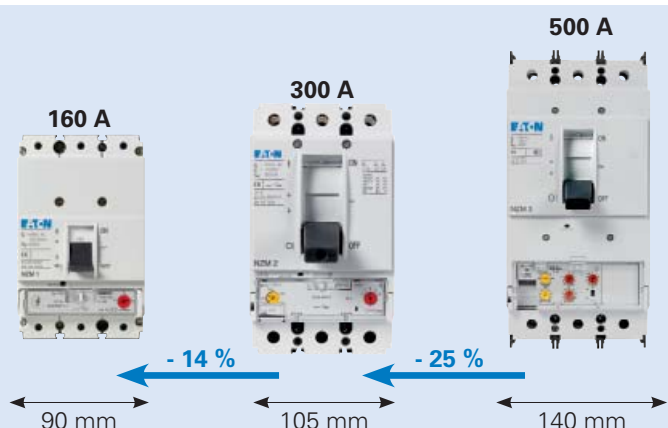

# Economically dimensioned. Circuit-breakers with 36 kA



NZM02EN

Online catalogue Quicklink to  
[www.eaton.com/moellerproducts](http://www.eaton.com/moellerproducts)

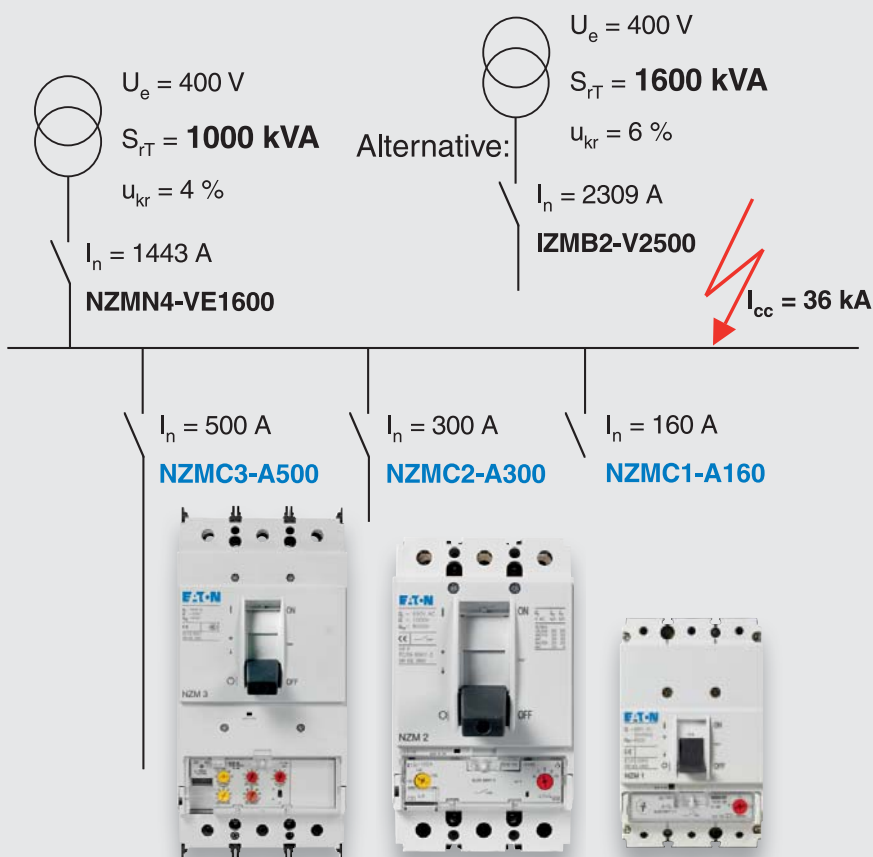

## Circuit-breakers from the new

**C series with 36 kA** short-circuit breaking capacity and nominal current from 20 - 500 A are the correct choice for the most frequently used standard applications. The decisive factor for the level of the short-circuit current in the most widely used low-voltage radial networks is the capacity of the low-voltage transformer.

With 36 kA breaking capacity, the highest short-circuit currents of the conventional 630 kVA transformer class – even with a double parallel connection – are mastered. Even for power networks with transformers up to 1600 kVA, the attractively-priced switches of the new C switch series are the first choice.

They are derived from the high-performance type of the modern Eaton NZM series and also feature their good system features and simple handling characteristics. The thermomagnetic releases can be adapted over a wide setting range to the permissible loading currents of the equipment to be protected. They can be equipped with accessories suited for every application in power distribution networks or for the equipment on electrical machines.

Low-voltage power transformers			
Rated Voltage $U_n$	400/230 V		
Short-circuit voltage $U_k$		4 %	6 %
Rated power S kVA	Rated current $I_n$ A	Short-circuit current $I_k''$ A	
50	72	1 805	–
100	144	3 610	2 406
160	230	5 776	3 805
200	288	7 220	4 812
250	360	9 025	6 015
315	455	11 375	7 583
400	578	14 450	9 630
500	722	18 050	12 030
630	909	22 750	15 166
800	1 158	–	19 260
1 000	1 444	–	24 060
1 250	1 805	–	30 080
1 600	2 312	–	38 530

≤ 36 kA



“In practice the short-circuit current is attenuated by about 10 % due to the cable connection between the transformer and main power distribution. Thus, the Comfort class is the perfect solution for transformers up to 1600 kVA.”

# Switch-disconnectors and circuit-breakers for DC current applications



NZM03EN



Online catalogue Quicklink to [www.eaton.com/moellerproducts](http://www.eaton.com/moellerproducts)

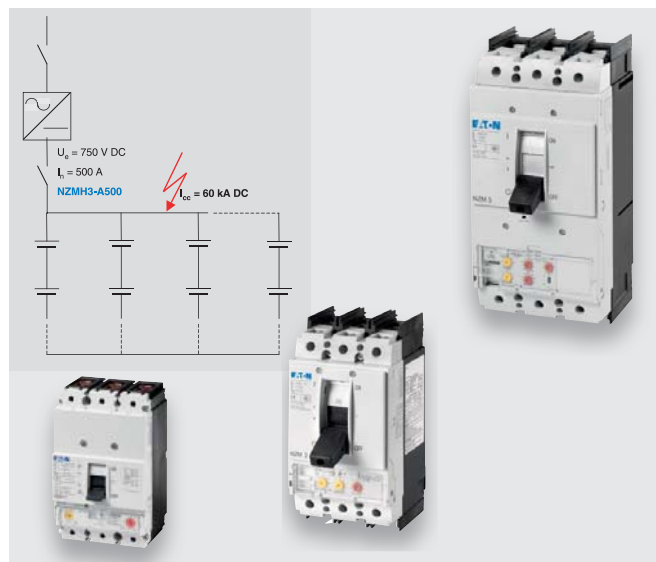

## Switch-disconnectors up to 1600 A

Eaton is offering DC switch-disconnectors specially designed for large photovoltaic plants such as energy parks. These are available in three sizes 200 A / 500 A / 1600 A with a differentiated rated current and a maximum rated voltage of 1500 V. All switches can be used at ambient temperatures up to 65 °C without limitation or derating. If users also require overload and short-circuit protection in addition to the basic isolating function, circuit-breakers are available in three sizes with a rated current of up to 500 A and a maximum rated voltage of 750 V.

All switch-disconnectors switch the plus and minus pole together. Jumper kits that provide easy-to-install current connection across all four contacts are available up to an ambient temperature of 70 °C. A protective cover offers allround touch protection and fingerproof protection to IP2X. The switches comply with the isolation properties even for earthed IT networks.



## Circuit-breakers up to 500A

The circuit-breakers can either switch on three poles, only plus or minus, or alternatively one and two poles of either plus or minus cables. The short-circuit switching capacity is between 15 kA to 70 kA depending on the device type selected. The switches can be used universally because of the high DC-3 utilization category: ranging from photovoltaic to emergency-generating unit batteries to sophisticated switching and protection of DC shunt-wound motors in reverse and jog mode.

For these DC applications, the users can use the circuit-breakers with a thermo-magnetic release system from the standard Eaton range. Accessories, such as connection terminals and door coupling rotary handles enable individual installation in the most varied of distribution systems. Auxiliary switches, voltage releases and remote operators facilitate signalling and automation.

DC switch disconnectors										
Construction design	open									
I <sub>n</sub> at DC22A (A)	160	200	320	400	500	800	1000	1250	1400	1600
U <sub>e</sub> (VDC)	1000/1500									
Number of poles	2									
Part no. 1000 V	N2-4-160-S1-DC	N2-4-200-S1-DC	N3-4-320-S1-DC	N3-4-400-S1-DC	N3-4-500-S1-DC	N4-4-800-S1-DC	N4-4-1000-S1-DC	N4-4-1250-S1-DC	N4-4-1400-S1-DC	N4-4-1600-S1-DC
Part no. 1500 V			N3-4-320-S15-DC	N3-4-400-S15-DC	N3-4-500-S15-DC	N4-4-800-S15-DC	N4-4-1000-S15-DC	N4-4-1250-S15-DC	N4-4-1400-S15-DC	N4-4-1600-S15-DC
Dimensions										
Width (mm)	140		185			280				
Height (mm)	184		275			401 (613 incl. connection kit 1400A 65°C)				
Depth (mm)	149		166			207				



Switch-disconnector 3-pole

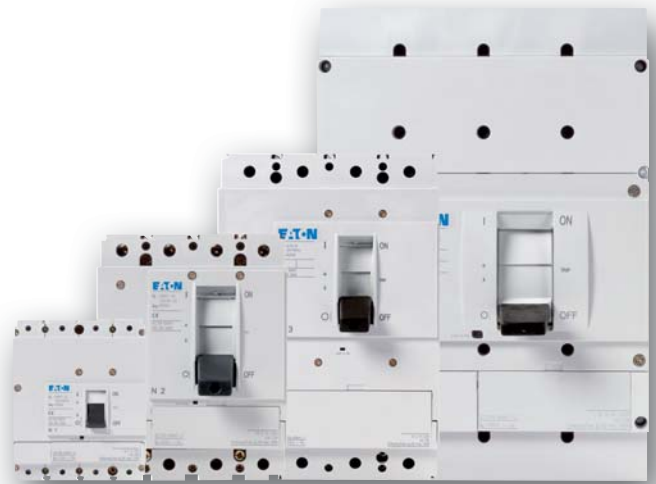

Switch-disconnector 4-pole



## Excellent under load – Switch-disconnector's for safe switching under load

Even under load conditions the Eaton switch-disconnector operates safely. The reason: the 3- or 4-pole snap-action closing mechanism which is also applied with circuit-breakers.

That's why the rated short time withstand current is so high and can handle currents up to 150 000 A. The long lifetime with up to 7 500 switching operations in AC3 mode enables usage as a motor switch, in order to switch large motors during operation. Application as a main switch with an emergency-stop function via a remote pushbutton is easily implemented in conjunction with the double early-make auxiliary contacts and undervoltage release. This in conjunction with the UL/CSA approvals is a prerequisite for use in process and processing machines which are destined for export.

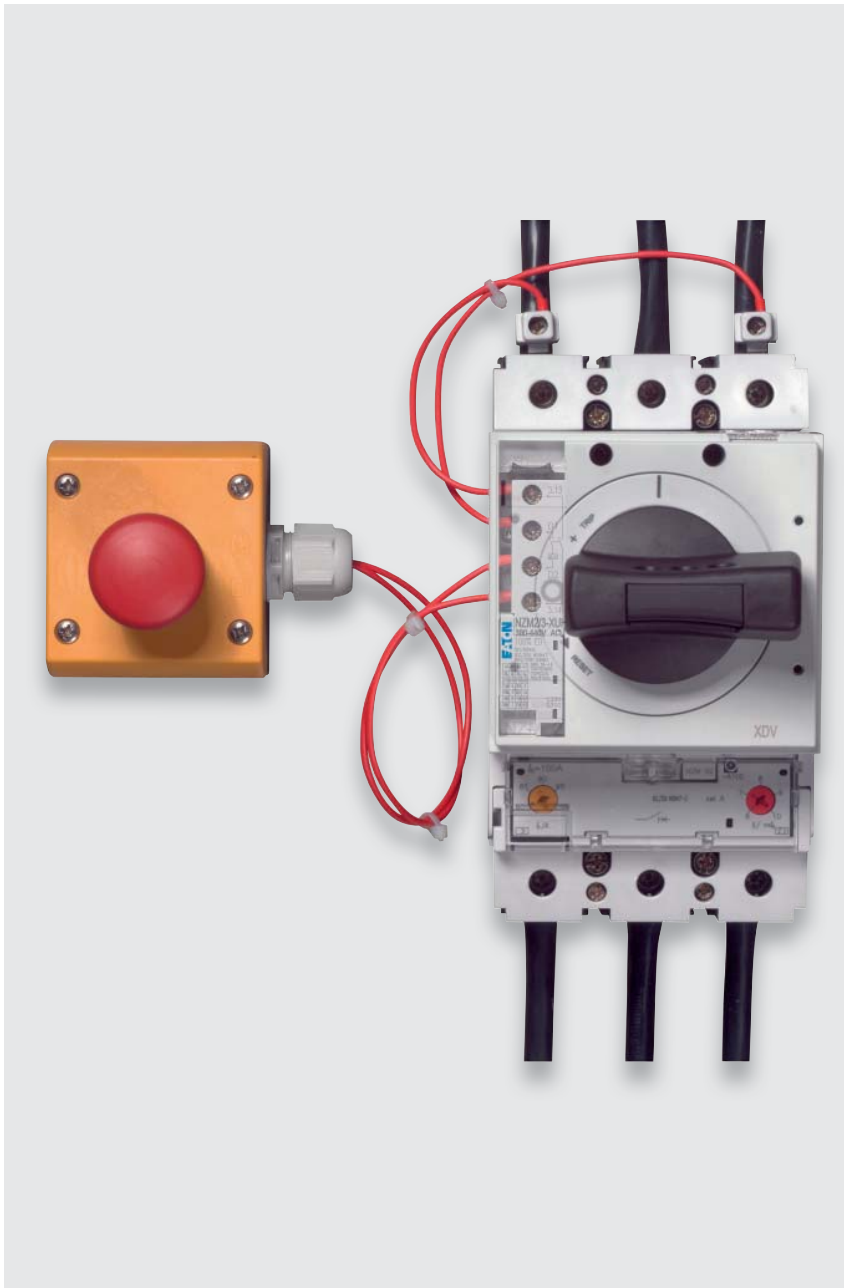

### Main switch application

The main switch application with an emergency-stop function up to 1600 A conform to IEC/EN 60204-1, VDE 0113 Part 1 can be easily and cost-effectively implemented with the new Eaton products.

The voltage is switched off on all current conducting circuits are when the switch is switched off using the undervoltage release with two integrated early-make auxiliary contacts. Safety is guaranteed at all times in this manner when the switch is in the Off position.

The early-make auxiliary contacts can always be installed – even if the circuit-breaker is equipped with a toggle-lever or rotary drive.

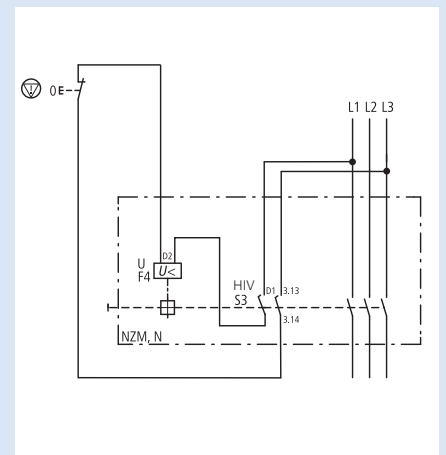

Switch-disconnector	PN1/N1	PN2/N2	PN3/N3	N4
Application range in A	63 – 160	160 – 250	400 – 630	800 – 1600
Number of poles	3/4	3/4	3/4	3/4
Rated voltage in V	690	690	690	690
Switch-disconnectors for North America	NS1-NA	NS2-NA	NS3-NA	NS4-NA
Application range in A	63 – 125	160 – 250	400 – 600	800 – 1200
Number of poles	3	3	3	3
Rated voltage in V	480	600	600	600
Dimensions in mm				
Width 3/4-pole	90/120	105/140	140/185	210/280
Height	145	184	275	401
Depth	68	103	120.5	138

New in the range:

Specially for the North American market: Molded Case switches featuring a short-circuit release for self-protection. Thus, the use of a back-up fuse is no longer required in many applications, e.g. as a main switch.



# Protection flexibility: Systems, generators, motors



1



## 1 NZM protects systems

Circuit-breakers NZM protect entire systems as well as cables and wiring on all levels, from the main distribution board right up to the loads. As the incoming circuit-breaker, the NZM will of course also provide secondary side overload protection for the transformer. A variant with modified short-circuit releases also enables a power network with time selectivity.

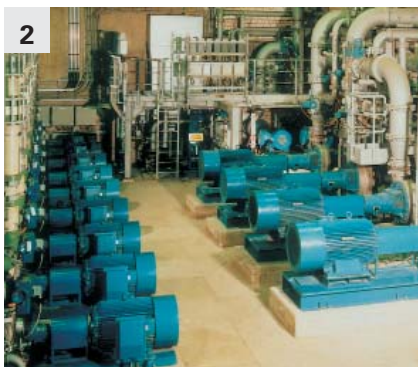

2



## 2 NZM protects motors

Circuit-breakers NZM protect motors and cables against overloads and short-circuits. The short-circuit release of the NZM can be set to 12 to 14 times the rated motor current to ensure that starting current peaks are not shut down by the protective device. Circuit-breakers NZM provide reliable and phase failure sensitive protection for motors from 15 A to 1400 A.

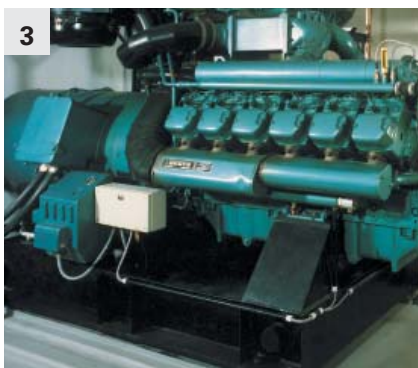

3

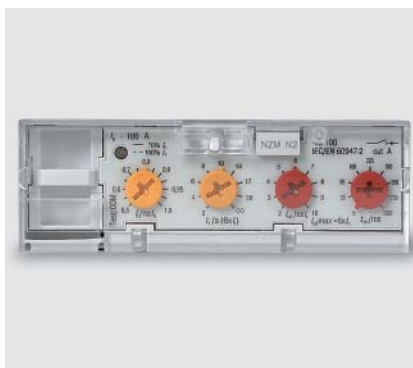

## 3 NZM protects generators

Even when the generators have difficulty generating two to six times the continuous current, it does not present a problem for the NZM. It can master shutdown of even the smallest short-circuit currents within a few milliseconds. A setting which ignores short-circuit currents for up to 1 s is possible for special tasks.



4



## 4 NZM protects with fault currents

The mains and auxiliary voltage independent residual current circuit-breaker trips as soon as the set rated fault currents are exceeded. The module is pulse current sensitive and also discriminative.

The  $I_{\Delta N} = 30 \text{ mA}$  in this function module also ensures personnel safety.

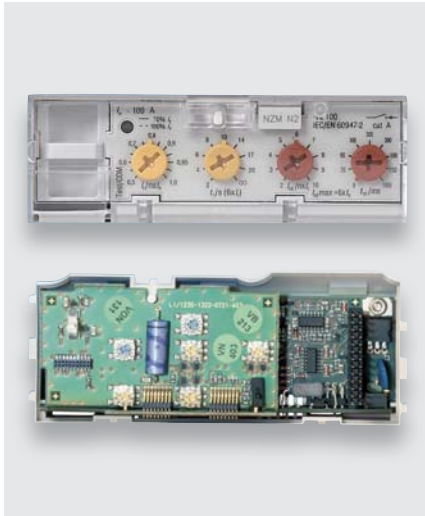

### Trip electronics featuring micro-processors enhance the operating continuity

The microprocessor controlled digital electronics determine r.m.s. values for the load current to be monitored. In contrast to analog electronics, any harmonics which may be in the power grid will be correctly evaluated and do not cause premature and unexpected trips. This prevents a standstill.

Special components simulate a thermal memory even when the switch trips

during a currentless period due to a load overload. Thus, safe protection of the connected equipment is guaranteed – even when the device is switched back on after a brief cooling off phase.

All electronics have been routinely tested and preaged in an oven. This corresponds to a real operating time of about six months. Thermocouples guarantee a safety-oriented trip of the circuit-breaker in the improbable case that an inadmissible overtemperature is due to the electronic components.

### Selectivity table

Circuit-breakers NZM achieve selectivity during a short-circuit even without additional electronic short-time delayed devices. For example, the 1000 A circuit-breaker in combination with a 300 A outgoing circuit-breaker is fully selective up to a maximum existing short-circuit current of 100 000 A. Even two high energy incoming supplies of e.g. two parallel 2 000 kVA distribution transformers are cost-effective and are simple to engineer with high levels of supply reliability.

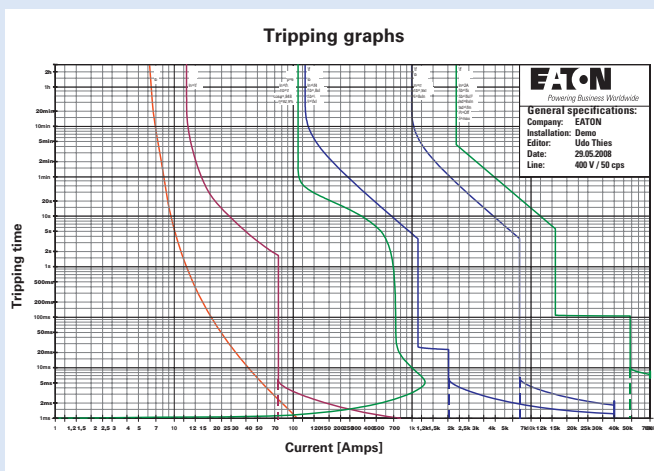
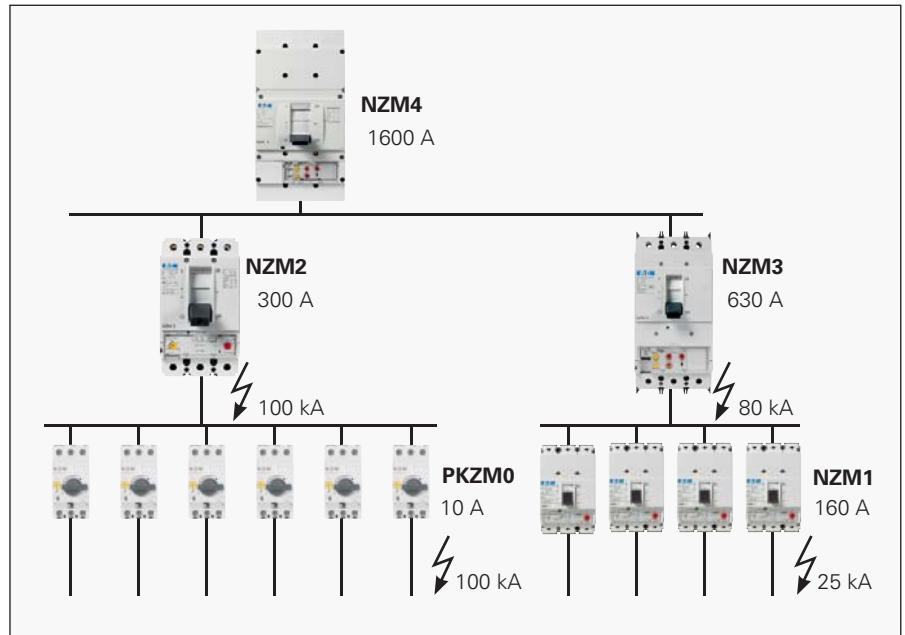

### Simpler visualisation, comparison and documentation of characteristic curves

The free-of-charge characteristic curve program supports documentation of the circuit-breakers which are used in completed switchgear systems. All setting parameters can be easily determined, graphically displayed and printed-out. A direct comparison of circuit-breaker NZM and circuit-breaker IZM in combination with h.b.c. fuses enables assessment of the selectivity for the overload and time-delayed overcurrent range. Motor starting characteristics can be created which assist in the selection and adjustment of the corresponding protection device.



[www.eaton.eu/curves](http://www.eaton.eu/curves)

# System benefits – the universal accessory range



NZM05EN



Online catalogue Quicklink to  
[www.eaton.com/moellerproducts](http://www.eaton.com/moellerproducts)

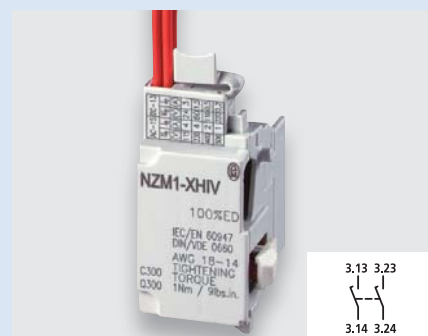
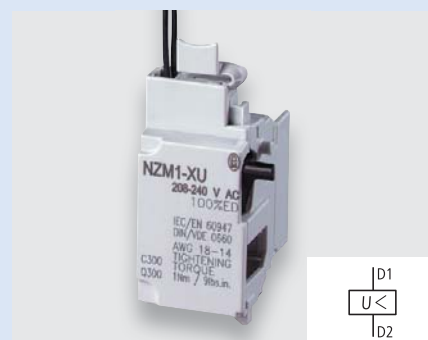
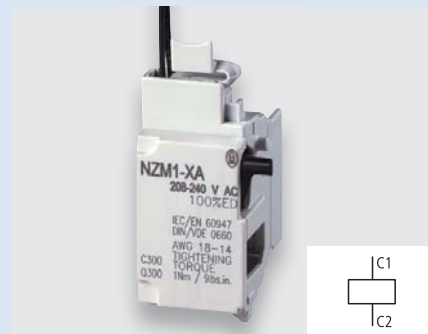

The method of functioning and fitting of the accessories is identical for every size.

Contact elements from the RMQ-Titan® range of control circuit devices are used for the entire NZM range of circuit-breakers.

This has many advantages: it ensures a reduction in the variety of types, a decrease in ordering expense and effort and consequently, simpler inventory management. The contact elements can be simply clipped-on from the front. The position determines the function: signalling contact or trip-indicating auxiliary

contact, and like all auxiliary contacts and releases, they are available with terminal bolts or spring-loaded connections, for circuit-breakers or switch-disconnector's. The new twin contacts provide twice as many auxiliary and signalling contacts in the same amount of space. They feature spring-loaded terminal connections.

## Flexible solutions for safety and interlock functions

Effective shunt or undervoltage releases, combined also with early-make auxiliary contacts for Emergency-Stop functions or load-shedding circuits, offer elegant solutions for a wide range of functioning applications. All contact points are available with sturdy bolt connection.



### All messages in detail – the Data Management Interface

It does not matter if the causes for a trip or a warning message with unbalance are required, or if all phase currents are to be displayed directly on-site and corrective actions are to be implemented with a critical load state. The Data Management Interface (DMI) always signals exact details. The relay outputs of the DMI signal up to 6 different messages. All trip causes are available as group signals and  $I_i$ ,  $I_r$ ,  $I_{sd}$ ,  $I^2t$ , and  $I_{dn}$  detail signals. The trip cause, phase state, switch setting as well as date and time can be accessed via the 4-line display. Representation of the actual phase currents can be in absolute or relative (%  $I_r$ ) terms. Warnings with regard to the load status are issued at 70 %, 100 % and 120 %  $I_r$ . Thus, the DMI is perfect for direct display on-site or for the integration in higher-level energy management concepts.



### A single tool for all screws

The heads on all screws used in the circuit-breakers – with the exception of the main connection screws – feature a plus-minus profile. The advantage is that a fast screw driving machine can be used with the single Posidriv 2 screwdriver tool, or alternatively, a flat-bladed screwdriver can also be used. This applies for all fixing screws, auxiliary connection terminals, as well as hinged flaps and covers and also all setting buttons.



The plus-minus slot can be used like the Pozidriv slot to apply a high torque and provides improved centring performance and a lower high loading pressure to an area. Furthermore, it can be used with several tool designs and is particularly suitable for high-maintenance devices.

# Variable operation – toggle, turn, automatic operation



## Door coupling rotary handles – ergonomic switching

Shaft lengths which can be cut to suit enable device installation in various control panels and housings up to a depth of 600 mm. A cost-effective and simple to mounting solution is available for the narrowest component mounting where the switch makes direct contact with the cover.

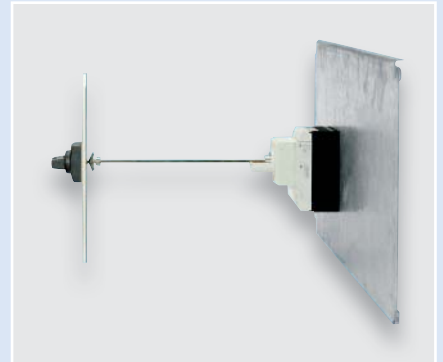

## The main switch types – the side operator

Up to 1600 A, the side wall operator enables the switch to be operated from the right or left hand side as desired. Optional fitting of our mounting bracket results in optimum use of space in the control panel. The mounting plate can thus be used for other machine control elements.



## The door coupling rotary handle – for uniform, flexible solutions

The base plate is the same for every door coupling rotary handle, this means faster fitting due to the identical drilling diagram. The switches can also be fitted vertically or horizontally in the control panel.

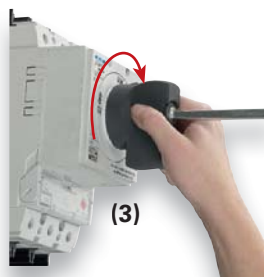
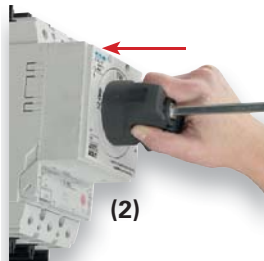
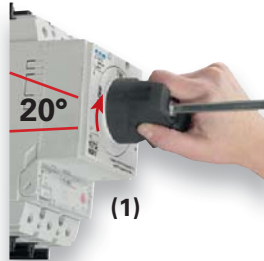

### Circuit-breaker NZM2: Rotary handle for main switches of machine controls in North America

The North American user guidelines prescribe that the actuating device must be permanently connected to the switch. This also applies when the control panel door is open. The new door coupling handle developed by Eaton, with additional handle on the switch, complies with this requirement. The new handle complies with the latest NFPA79 and UL508A standards in terms of a deliberate action.

The deliberate action is based on the presumption that the additional handle must initially be rotated by about 15° (1), so that it is subsequently pressed (2) and rotated (3) simultaneously to switch on the switch. The most important safety attributes, such as the actuation options, switch position indication and interlocking features, are provided twofold, both externally on the door coupling rotary handle as well as internally on the switch.





### Application related locking

Multiple versions of the door coupling rotary handle provide individual solutions.

- The standard handle features automatic handle position locking, which facilitates comfortable locking of control panel doors even with differing switch positions.
- The second version can be locked with padlocks and automatically locks the doors when closed. This is the typical application for a main switch as the control panels can only be opened in the Off position.
- With the third version, there is an additional locking feature directly on the switch. For example, the switches can be locked individually in a complex energy distribution system.

Handles in red/yellow contrasting colours are available for the emergency-stop function.

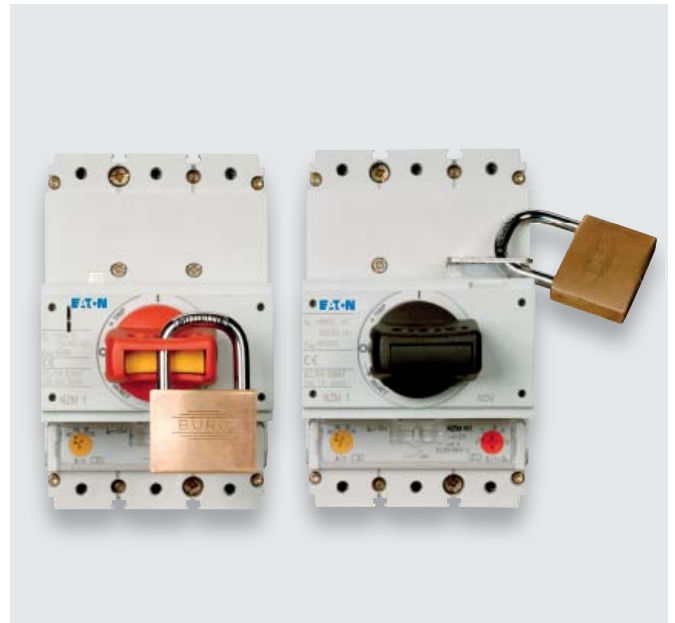

### Operator on rear for switches up to 300 A rated current

If a power disconnecting device with door coupling rotary handle is to be used in a confined space: up to 300 A rated current can be quickly mounted using the compact mechanical features and comfortably operated using the solid rotary handle. All switch variants from the NZM1 and NZM2 range – regardless of if they are circuit-breakers or switch-disconnectors – can be combined with a rear operator.



### The economic remote operator for standard tasks for NZM2 to NZM4

The switching time of the new remote operator is a max. of just 170 ms and can thus be used with standard applications for automated or remote operated energy control.

The folding mounting plate enables a quick inspection of the installed auxiliary contacts and voltage releases. The narrow construction design of the remote operator requires no additional mounting area. It is equipped with a selector switch which guarantees a secure differentiation of the connected positions. Furthermore, the switches can be securely locked in the 0 setting using padlocks.

### The comfortable remote operator for synchronisation tasks for NZM2 to NZM4

The spring-powered actuator permits closing delays of 60 or 100 ms, thereby also allowing application in the field of synchronization. Short function sequences and fewer parts ensure a high degree of stability and a long service life. Safety is also emphasized here by the sealing option for the Auto function and by the facility for padlocking the remote operator.



# Safe to operate, easy to handle

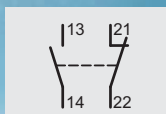

## The plug-in unit – open to possibilities

The plug-in feature enables rapid and uncomplicated exchange of circuit-breakers without having to shutdown the entire system. The same widths for the fixed and withdrawable circuit-breakers ensure simple engineering during the system design phase.

A very visible isolating distance can be implemented in addition to the isolating characteristics by the use of plug-in breakers. The open plug-in contacts are finger-proof (IP2X).

If the system is to be modified at a later date, the use of plug-in sockets for reserve outgoing is recommended.



## The withdrawable unit – signalling of states

As usual, Eaton offers plug-in and withdrawable units in addition to the fixed mounted option. It makes it easier to quickly adapt to malfunctions or increases in the rated current range and thus avoid long downtimes. Uniform racking handle operation for withdrawable units enhances operating safety and ensures a test position for function testing without having to switch the main contacts.

The "Inserted", "Test" and "Retracted" positions can be remotely signalled using auxiliary switch contacts RMQ.



## Mesh network switch provides enhanced trip security

Eaton offers two solutions for the mesh network switch application: a shunt which functions as specified in a range from 10 to 110 % of the control voltage, and a special shunt release which also provides trip security in conjunction with a capacitor unit, if up to 12 hours have elapsed since the power loss.

### Interlock with Bowden cable technology

Mechanical interlock components enable the interlocking of two or three switches, equipped with rotary handles (a) or remote operators (b), which can also feature different frame sizes. The Bowden cable technology enables free installation of the switches in differing positions. The switches can be installed up to 1 m apart – e.g. in different control panel sections.

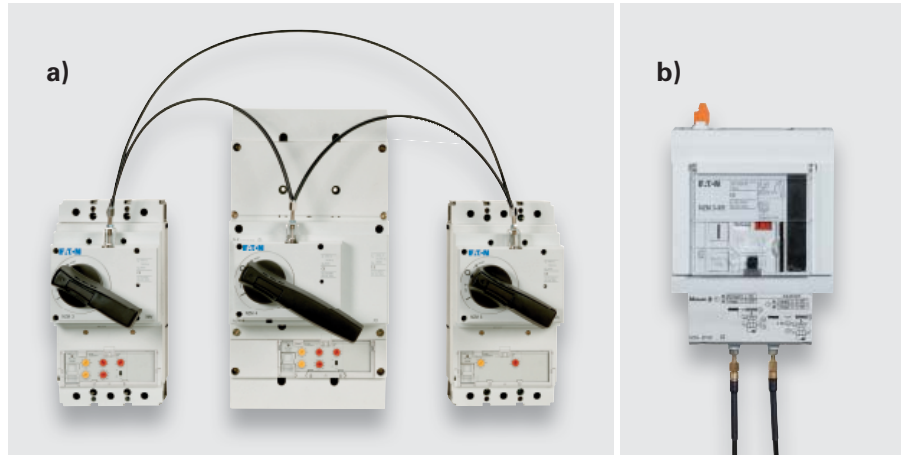

### Parallel operation: smart technology

Parallel drives for switches up to 630 A enable simultaneous switching with just a single action – e.g. with main or auxiliary circuits. In this manner the main and auxiliary circuits can be switched simultaneously with process and processing machines.

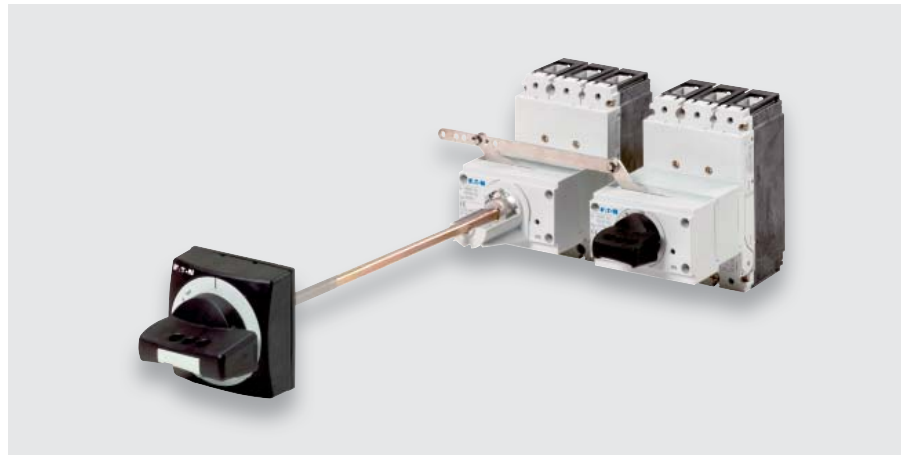

### Busbar adapter

Busbar adapters featuring space-saving contacts enable installation of many devices in confined spaces. They can be used universally on every 60 mm busbar system. The three frame sizes for 160, 250 as well as 630 A can be snapped on.

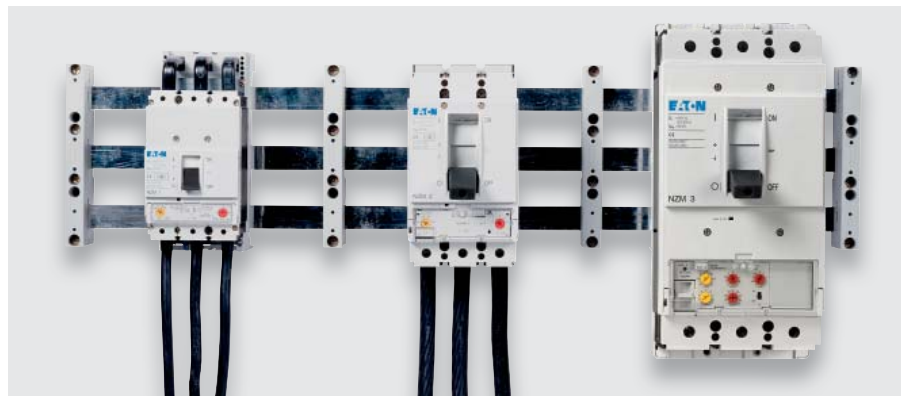

### Switches in enclosures – certified safety

The transparent enclosures available with protection degrees up to IP 65 provide mechanical protection with impact resistant polycarbonate. The 3- and 4-pole switches are equipped ready for installation with rotary handles. Additional isolated terminations for a 4th or 5th conductor are also available.

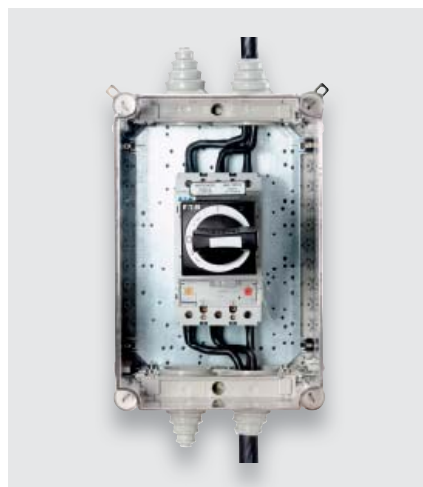

“You realise the competence of the people working for Eaton with every solution. All the features you require are implemented.”



# Clever mounting and connection increases economy



**Back of hand or finger-proof**

Cable-lug, box-terminal or tunnel terminal, it does not matter as covers will always ensure that they are back-of-hand proof.

Fingerproof to IP2X, conform to IEC/ EN 60204-1 for main switches is fast and easy to implement. The new additional covers can be matched to every cross-section.



## 1 Easy to connect

Circuit-breakers NZM and switch disconnectors PN, N can be connected with and without cable lugs, braided copper bands or copper busbars. And there's another special feature: Special narrow cable lug versions are available for bolt connection of round conductors up to 240 mm.

## 2 Screw terminal

The screw terminal is the most attractively priced solution for the connection of cable-lugs, flat drilled metal strip or copper busbars.

## 3 Box terminal for copper cable

Box terminals guarantee secure contact for the direct connection of 1 – 2 flexible copper conductors or flat strip. With NZM2 and NZM3, the top of the box terminal can be opened for easy insertion.

## 4 Terminal for aluminium and copper cables

The terminal area of these special terminals is tunnel-shaped to prevent the typical "flow-properties" of aluminium under great pressing power. Up to four copper or aluminium conductors can be connected depending on the type.

## 5 Connection preparation for multiple conductors

It enables the connection of up to six conductors with cable lugs per phase. Auxiliary busbars are no longer required.

## 6 Rear connection

This method of connection allows busbars or round conductors to be connected at the rear. Partitioning of the switch area, terminal area and operator area is carried out without difficulty.

### Control circuit terminals

The control circuit terminals are simply screwed onto the respective connection type. The tap-offs for voltage meters, control transformers and undervoltage releases are implemented quickly.

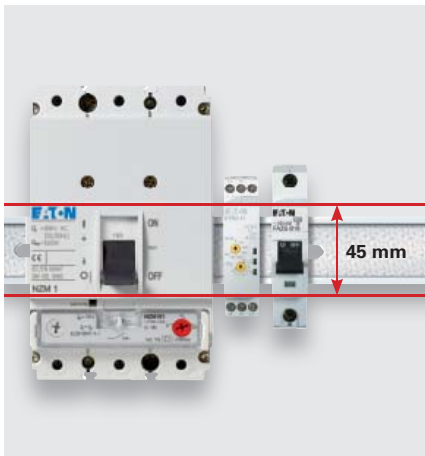

### The spacer – saving time and expense

All switches including the accessories fitted on them were designed with the grid spacing of the spacer. Different depths of switch are evened-out simply by means of inexpensive, rapidly fitted spacers.

The result is a cost-effective alternative to the door coupling rotary handle with extension shaft for external operation of the circuit-breaker.

This worldwide innovation gains time and saves expense.

### Clever installation and terminations

Fast and efficient top-hat rail installation with the use of a clip plate. Just simply attach the clip plate from the rear onto the circuit-breaker and clip it onto the top-hat rail. No need to drill holes in the mounting plate.

The particular advantage of the small NZM1: the "standard dimension" enables side-by-side installation with miniature circuit breakers in service distribution boards.

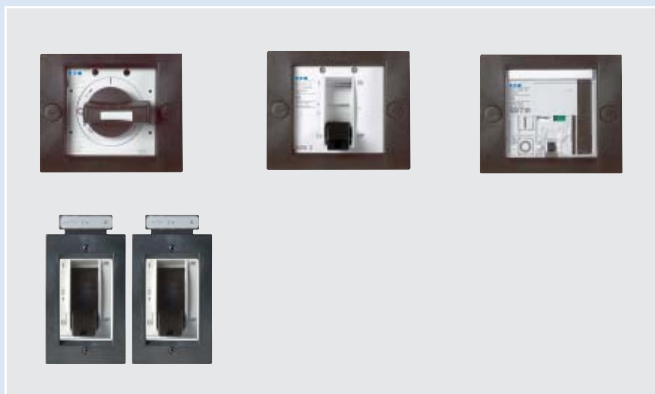
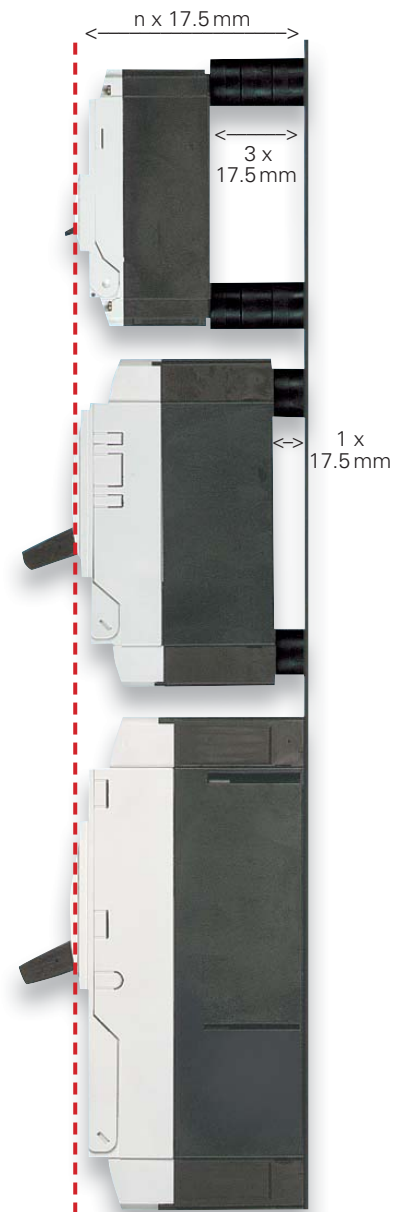

The insulating surrounds have IP 40 degree of protection and the inscription labels can be simply clipped in.

### Insulating surrounds – always the right fit

The insulated surround always fits. Regardless of if the circuit-breaker is equipped with a toggle-lever, rotary drive or remote operator. It is unnecessary to keep differing insulating surrounds in stock. It is the cost-effective method to operate circuit-breakers externally when the control panel door is closed.

### Insulating surround XBRS for the toggle lever

Narrow design for space-saving side by side mounting.

# Diagnostics included! NZM circuit-breakers

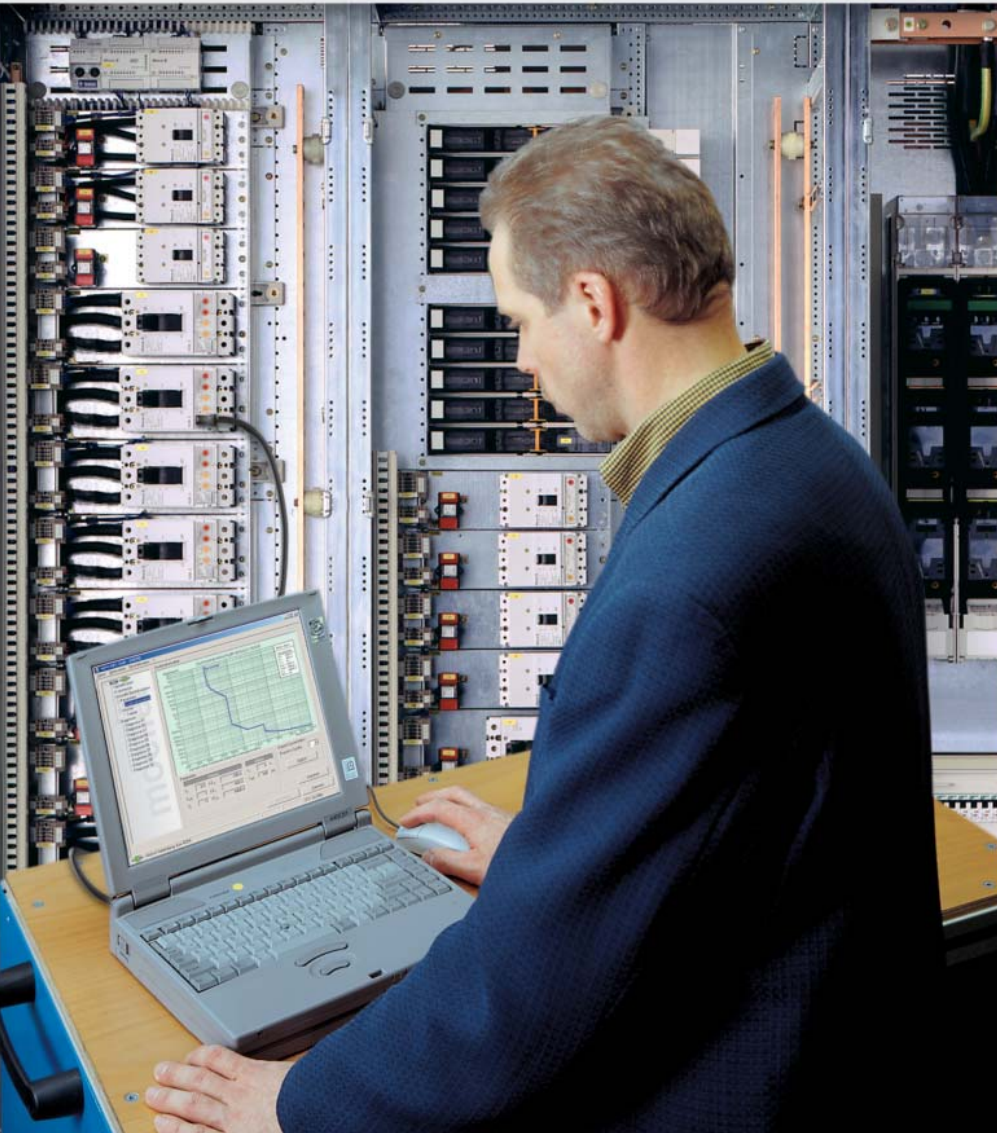

## **NZM provides the quick overview – directly onsite**

NZM delivers all the necessary diagnostics information via an integrated interface directly to a PC or laptop. Configuration in advance is not necessary.

The connection is quickly established: Simply plug the connection cable into the front of the intelligent electronic trip unit – and you are ready to go. This diagnostics access is possible at any time, regardless of if the system is operational or not.

## **NZM circuit breakers provide on-site diagnostics – easily accessed from its clever electronic trip unit**

NZM circuit breakers protect people, installations and power supply networks. Faults are immediately recognised and reliably disconnected – but the following must be clarified in order to quickly re-establish the power supply safely.

- Was there an overload or short-circuit?
- Which phases were affected?
- Which chain of events led to the trip?
- Have settings been adjusted in the meantime?
- Is it possible – and more importantly – is it safe - to re-close the circuit breaker and restore power?

In such events NZM circuit breakers from Eaton provide valuable insight with diagnostic information that's quickly and easily accessible with a standard PC.

**“System diagnostics was never so easy to implement. That’s what I call Plug & Work!”**



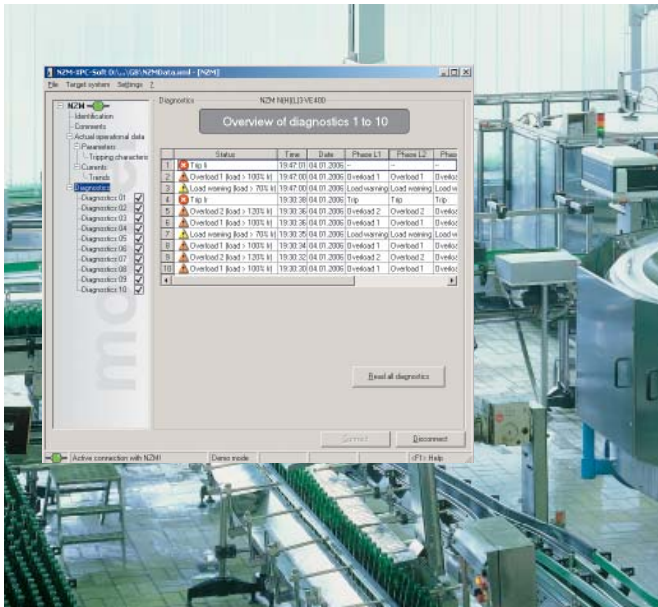

### NZM provides diagnostic analysis after a fault that eliminates ambiguity and error!

The cause of a trip is documented by the clever circuit-breaker NZM in its internal memory. Ten events are logged in detail which enables the source of the fault to be quickly identified based on hard facts. The information is clearly and unambiguously displayed onsite with the NZM-XPC-SOFT software. It can be saved as a file, printed and sent for the purpose of analysis.

The NZM event protocol eliminates ambiguities and “human error” of keeping notes during the entire lifecycle of the circuit-breaker and the low-voltage installation. Even replacement circuit-breakers can be identified and traced based on their serial number.

The NZM-XPC-SOFT supports nine languages for maximum safety and operating availability world-wide.

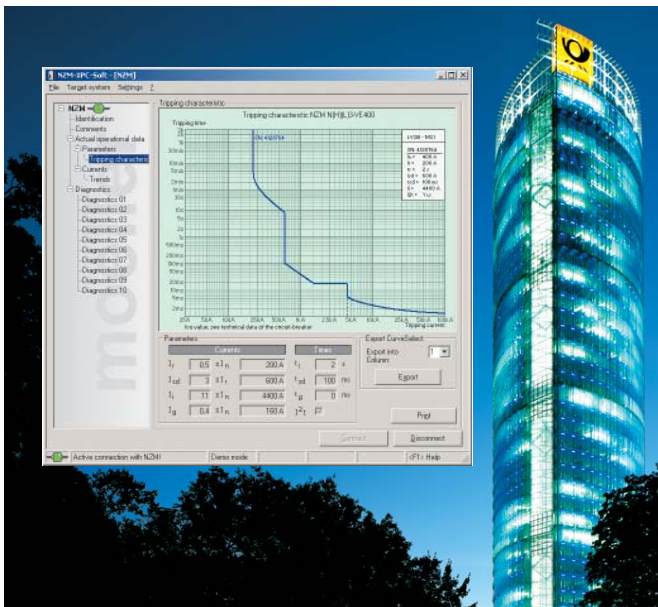

### NZM validates protection settings at a glance

With NZM a power disruption can be limited to the areas which are directly affected by the fault using a selective design concept. The effects and costs of a malfunction are minimised without making any compromises in safety.

The active tripping curve and the planned selectivity can be exactly represented in the NZM-XPC-SOFT based on the selected switch settings and tripping characteristic. Selection of the optimum protective parameters and validation of the desired selectivity is supported during the commissioning phase by a direct comparison of the upstream and downstream protective devices. Possible fault sources are immediately indicated by a visual comparison of the individual breaker settings. Later modifications are clearly illustrated. Even the matching of the protection settings of a specific motor characteristic is illustrated by graphic optimisation of the inrush-, starting- and operating current of the motor.

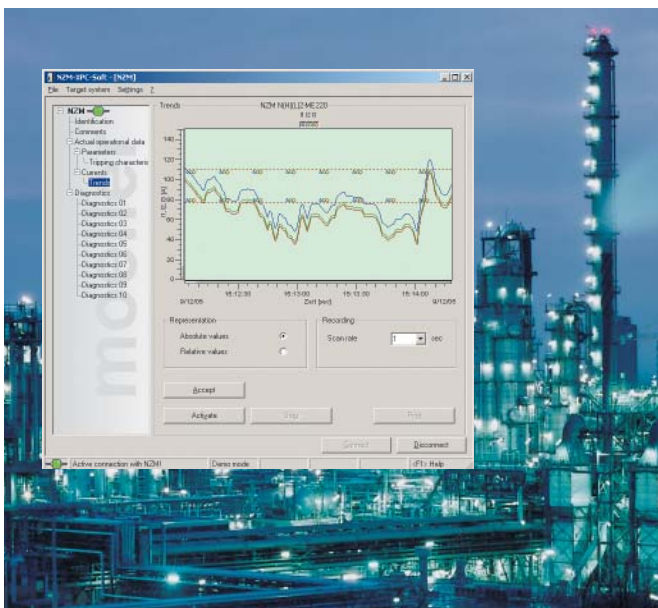

### NZM load analysis for valuable resource management

Electrical energy is a valuable and critical resource. Each clever NZM is capable of being transformed into a load analysis tool with the help of NZM-XPC-SOFT. Simply plug-in the PC connection cable at the electronic trip block and both graphical and data-logging trend measurement commences.

The effective values of all phases can be recorded over the time periods of minutes, hours or even days. Power distribution is therefore transparent.

Measurements and trends over defined periods can be compared or processed further using the protocol function to generate files for MS Excel®.

Evaluating the performance of manufacturing processes and assessing preventative maintenance of motors are examples of important resource management functions easily carried out with this simple software.

# Metering and communication module for energy distribution and motor control centres



## The new compact solution

A combination of current transformer, voltage tap-off, measurement electronics, fieldbus interface and display interface in an enclosure is a very interesting solution. Four individual devices (3 current transformers and 1 measurement device) are combined in a single enclosure. Considerable wiring and installation effort and expense are avoided. The installation of the metering and communication module can be undertaken at any location in the control panel. The system is independent of the switch design and model. All existing circuit-breakers and switch disconnectors can be used, only the minimum clearances required by the design of the respective switches must be observed. This solution offers a very large range of applications and can even be retrofitted in a short time to existing switchboards.

## Recording energy consumption

The requirement for a simple metering function to detect the transferred energy is in demand with energy distribution and motor control centres. Energy is a precious resource and everyone is urged to conserve it. A prerequisite for reduction in consumption requires knowledge of the level of consumption, and accordingly simple sensors for recording energy consumption are becoming ever more important.

## The product range

The new range of metering and communication modules (XMC) are specially designed for circuit-breakers NZM2 and NZM3 and can be used universally in a voltage range from 35 V - 500 V and in a current range from 65 - 630 A. There are two sizes matched to the NZM current ranges. Size 2 (NZM2-XMC) extends up to 250 A and size 3 (NZM3-XMC) accordingly up to 500 A. Each of these sizes are available as 3 or 4-pole versions.



compact



- + universal
- + simple installation
- + low price



### XMC as a data source for 3 recipients

All relevant data is provided for the control level in addition to the local display for on-site personnel. These include the current states OPEN/CLOSED/TRIP of the circuit-breaker as well as control of a remote operator for automatic switch functions. The **management level** is concerned with the present values of currents, voltages and powers which can be individually displayed as well as saved. The course for optimization of consumption can be set here.

### Mechanical connection

A central factor in its success is the simplicity of the mechanical installation of the devices. The cables or braids are connected through the apertures of the XMC to the switching/protective device. They can be mounted on both the incoming and outgoing side. The tunnel diameter for the NZM3 modul



### Pre-processing in the XMC enables load shedding

Pre-processing means reducing the load on the processing stations. A simple form of optimization is load shedding. If a defined threshold is reached, a digital output can be controlled that is integrated into the interlock. A range of digital and analog input/output expansion boards are available for this extended functionality. These boards are installed in the base unit and can be supplied directly with the unit, or retrofitted later. The following expansion boards are available:

1. 2 outputs as a changeover contact
2. 4 outputs as NO contacts
3. 4 digital inputs / 4 digital outputs
4. 1 analog output 4 - 20 mA / 1 - 10 V

As an intelligent pre-processing unit the XMC offers further information for the control and management level. For example, the **maximum values** of measured values can be calculated and issued over a time period, or **time window values** can also be mapped for a specific time. The XMC can also score points in terms of **diagnostics**. Load warnings can be issued to counteract tripping due to an overload.

type with a diameter of 27.5 mm is suitable for max. 185 mm<sup>2</sup> conductor cross-sections. Alternatively, a 11 x 21 x 1 mm copper braid can be used. An adapter is supplied for smaller conductors.

	Part no.	Number of poles	Maximum rating	Main Mainfeature
	<b>NZM2-XMC-S0</b>	3	300 A	Digital S0 output
	<b>NZM3-XMC-S0</b>	3	500 A	Digital S0 output
	<b>NZM2-XMC-MB</b>	3	300 A	Modbus, 2 S0 outputs, display interface
	<b>NZM3-XMC-MB</b>	3	500 A	Modbus, 2 S0 outputs, display interface
	<b>NZM2-XMC-MB-250</b>	3	250 A	Modbus, 2 S0 outputs, display interface
	<b>NZM3-4-XMC-S0</b>	4	500 A	Digital S0 output
	<b>NZM2-4-XMC-MB</b>	4	300 A	Modbus, 2 S0 outputs, display interface
	<b>NZM3-4-XMC-MB</b>	4	500 A	Modbus, 2 S0 outputs, display interface
	<b>NZM2-4-XMC-MB-250</b>	4	250 A	Modbus, 2 S0 outputs, display interface
	<b>NZM-XMC-USB485</b>			XMC-PC Cable to Configuration

Display for all Modbus types	Part no.
	<b>NZM-XMC-DISP</b>

Power supply for AC supply	Part no.
	<b>NZM-XMC-AC</b>

# System Overview

## Circuit-Breakers, Switch-Disconnectors

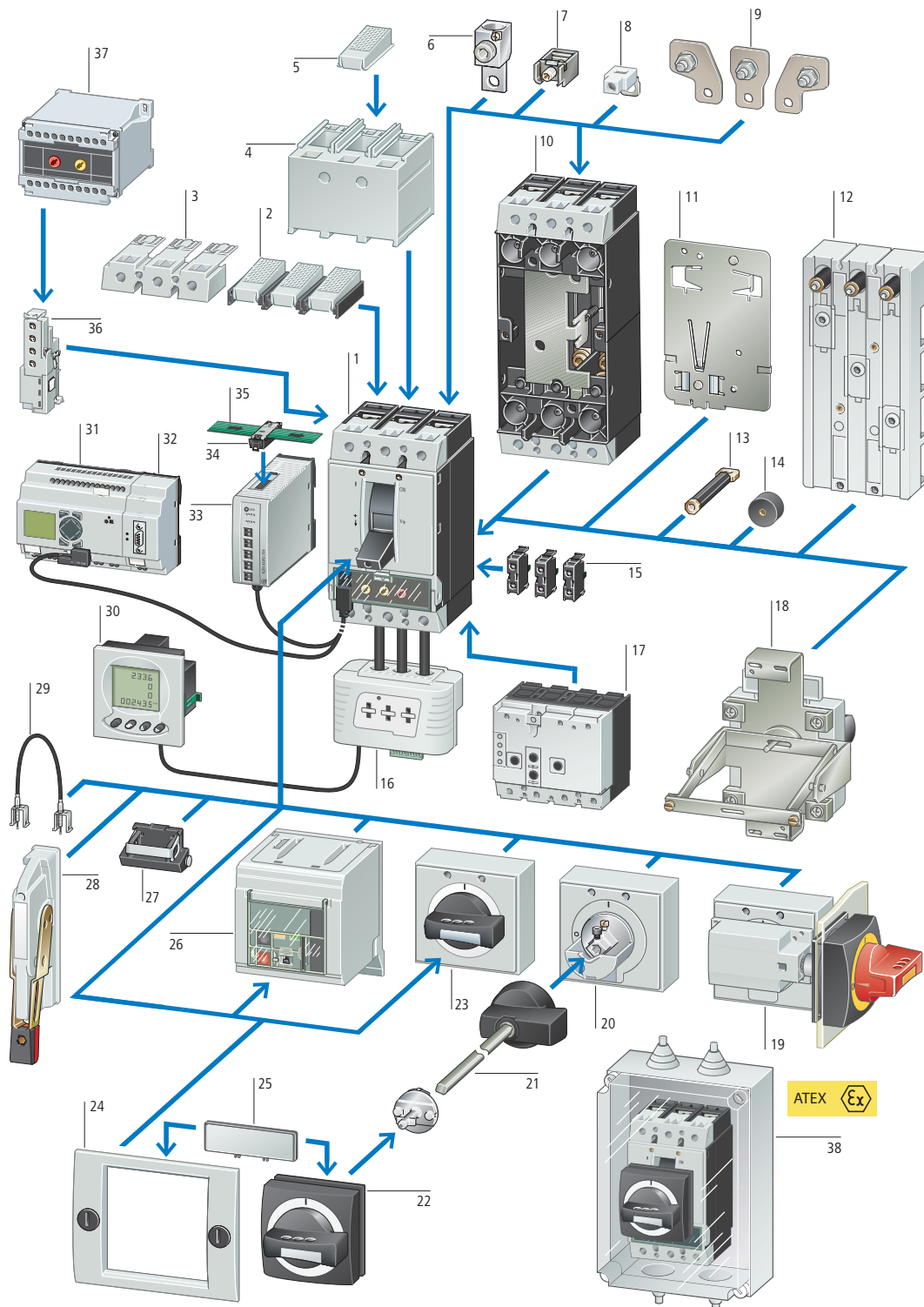

- |    |  |    |   |    |   |
|----|--|----|---|----|---|
| 1  | Switch-disconnector, circuit-breaker, circuit-breaker for North America; Moulded case switches for North America | 13 | Connection on rear  | 25 | External warning plate/markings plate     |
| 2  | IP2X protection against contact with a finger  | 14 | Spacers   | 26 | Remote operator                           |
| 3  | Terminal cover, knockout   | 15 | Standard auxiliary contact (HIV), trip-indicating auxiliary switch (HIA), voltage release | 27 | Toggle lever locking device               |
| 4  | Terminal cover   | 16 | Measuring and communication module  | 28 | Side operator handle                      |
| 5  | IP2X protection against contact with a finger  | 17 | Residual-current protection device  | 29 | Mechanical interlock                      |
| 6  | Tunnel terminal  | 18 | Rear driver   | 30 | Display                                   |
| 7  | Box terminals  | 19 | Main switch rotary handle for side panel mounting   | 31 | Data management interface (DMI module)    |
| 8  | Control circuit terminal   | 20 | Door coupling rotary handle   | 32 | PROFIBUS-DP interface                     |
| 9  | Connection width extension   | 21 | Extension shaft   | 33 | NZM communication module for Smartwire-DT |
| 10 | Plug-in and withdrawable unit  | 22 | Insulating surrounds  | 34 | Smartwire-DT                              |
| 11 | Adapter plate  | 23 | Rotary handle   | 35 | Smartwire-DT                              |
| 12 | Busbar adapters  | 24 | Insulating surrounds  | 36 | Early-make auxiliary contacts             |
|    |  |    |   | 37 | Delay unit for undervoltage releases      |
|    |  |    |   | 38 | Insulated enclosures                      |





## Switch Disconnectors

IEC/EN 60947-2  
UL 489

Switch-Disconnectors	3-pole IEC		4-pole IEC		IEC 3-pole UL/CSA	
	2 switch positions <sup>1</sup>	3 switch positions <sup>2</sup>	2 switch positions <sup>1</sup>	3 switch positions <sup>2</sup>	rated current = Rated uninterrupted current	3 switch positions <sup>2</sup>
rated current = Rated uninterrupted current $I_n = I_u$ <b>A</b>					$I_n = I_u$ <b>A</b>	
Box Terminals standard Terminal screws as accessories						
63 100 125 160	PN1-63 PN1-100 PN1-125 PN1-160	N1-63 N1-100 N1-125 N1-160	PN1-4-63 PN1-4-100 PN1-4-125 PN1-4-160	N1-4-63 N1-4-100 N1-4-125 N1-4-160	63 100 125	NS1-63-NA NS1-100-NA NS1-125-NA
Terminal screws standard Box Terminals screws as accessories						
200 250 400 630 800 1000 1250 1600	PN2-200 PN2-250 PN3-400 PN3-630 — — — —	N2-200 N2-250 N3-400 N3-630 N4-800 N4-1000 N4-1250 N4-1600	PN2-4-200 PN2-4-250 PN3-4-400 PN3-4-630 — — — —	N2-4-200 N2-4-250 N3-4-400 N3-4-630 N4-4-800 N4-4-1000 N4-4-1250 N4-4-1600	160 200 250 400 600 800 1000 1200	NS2-160-NA NS2-200-NA NS2-250-NA NS3-400-NA NS3-600-NA NS4-800-NA NS4-1000-NA NS4-1200-NA



<sup>1</sup> I, 0 ; Cannot be remotely operated

<sup>2</sup> I, +, 0 ; Can be remotely operated with U/A voltage release

## Circuit Breakers Motorprotection

IEC/EN 60947-3

Rated operational current = rated uninterrupted current $I_n = I_u$ <b>A</b>	Overload releases Setting range <b>I<sub>r</sub></b> <b>A</b>	Short-circuit releases Non-delayed $I_i = I_n \times \dots$	Rated operational power AC-3 50/60 Hz 400 V <b>P</b> <b>kW</b>	Rated operational current AC-3 50/60 Hz 400 V <b>I<sub>e</sub></b> <b>A</b>	<b>Basic switching capacity</b> <b>25 kA</b> 400/415V 50/60 Hz Part no.	<b>Normal switching capacity</b> <b>50 kA</b> 400/415V 50/60 Hz Part no.	<b>High switching capacity</b> <b>100 kA</b> 400/415V 50/60 Hz Part no.
<b>Motor protection, thermomagnetic release</b> NZM...1-M... with phase failure sensitivity, tripping class 10 A							
Box Terminals standard Terminal screws as accessories							
40 50 63 80 100	32-40 40-50 50-63 63-80 800-100	8 - 14 8 - 14 8 - 14 8 - 14 8 - 12.5	18,5 22 30 37 45	36 41 55 68 81	<b>NZMB1-M40</b> <b>NZMB1-M50</b> <b>NZMB1-M63</b> <b>NZMB1-M80</b> <b>NZMB1-M100</b>	<b>NZMN1-M40</b> <b>NZMN1-M50</b> <b>NZMN1-M63</b> <b>NZMN1-M80</b> <b>NZMN1-M100</b>	<b>NZMH1-M40</b> <b>NZMH1-M50</b> <b>NZMH1-M63</b> <b>NZMH1-M80</b> <b>NZMH1-M100</b>
Terminal screws standard Box Terminals as accessories							
125 160 200	100-125 125-160 160-200	8 - 14 8 - 14 8 - 14	55 75 110	99 134 196	<b>NZMB2-M125</b> <b>NZMB2-M160</b> <b>NZMB2-M200</b>	<b>NZMN2-M125</b> <b>NZMN2-M160</b> <b>NZMN2-M200</b>	<b>NZMH2-M125</b> <b>NZMH2-M160</b> <b>NZMH2-M200</b>
<b>Motor protection, electronic releases</b> with phase failure sensitivity, tripping class adjustable							
Terminal screws standard Box Terminals as accessories							
220 350 450	110-220 175-350 225-450	2 - 14 2 - 14 2 - 12	110 200 250	196 349 437		<b>NZMN3-ME220</b> <b>NZMN3-ME350</b> <b>NZMN3-ME450</b>	<b>NZMH3-ME220</b> <b>NZMH3-ME350</b> <b>NZMH3-ME450</b>









Thermomagnetic release						
Rated current = rated uninterrupted current	Overload release 1-pole	Overload release Setting range overload release	Short-circuit release 1-pole	Short-circuit release adjustable 3-pole	Circuit-breaker with Economy switching capacity 18 kA at 230 V 50/60 Hz	
					Part No.	Part No.
$I_n=I_u$ A	$I_r$ A	$I_r$ A	$I_i$ A	$I_i$ A	1-pole	1-pole
<b>Box terminals standard</b>						
16	16	-	350	-	NZME1-1-AF16	NZMB1-1-AF16
20	20	15-20	350	350	NZME1-1-AF20	NZMB1-1-AF20
25	25	20-25	350	350	NZME1-1-AF25	NZMB1-1-AF25
32	32	25-32	350	350	NZME1-1-AF32	NZMB1-1-AF32
40	40	32-40	350	320-400	NZME1-1-AF40	NZMB1-1-AF40
50	50	40-50	600	300-500	NZME1-1-AF50	NZMB1-1-AF50
63	63	50-63	600	380-630	NZME1-1-AF63	NZMB1-1-AF63
80	80	63-80	1000	480-800	NZME1-1-AF80	NZMB1-1-AF80
100	100	80-100	1000	600-1000	NZME1-1-AF100	NZMB1-1-AF100
125	125	100-125	1000	750-1250	NZME1-1-AF125	NZMB1-1-AF125
160	160	125-160	-	1280	-	-
<b>Terminal screws standard</b>						
20		15-20	350			
25		20-25	350			
32		25-32	350			
40		32-40	320-400			
50		40-50	300-500			
63		50-63	380-630			
80		63-80	480-800			
100		80-100	600-1000			
125		100-125	750-1250			
160		125-160	960-1600			
160		125-160	960-1600			
200		160-200	1280-2000			
200		160-200	1280-2000			
250		200-250	1500-2500			
250		200-250	1500-2500			
300		240-300	2000-2500			
300		240-300	2000-2500			
<b>Box terminals standard</b>						
20		15-20	350			
25		20-25	350			
32		25-32	350			
40		32-40	320-400			
50		40-50	300-500			
63		50-63	380-630			
80		63-80	480-800			
100		80-100	600-1000			
125		100-125	750-1250			
160		125-160	960-1600			
200		160-200	1280-2000			
250		200-250	1500-2500			
300		240-300	2000-2500			
<b>Terminal screws standard</b>						
320		250-320	1920-3200			
320		250-320	1920-3200			
400		320-400	2400-4000			
400		320-400	2400-4000			
500		400-500	3000-5000			
500		400-500	3000-5000			
<b>Box terminals standard</b>						
320		250-320	1920-3200			
400		320-400	2400-4000			
500		400-500	3000-5000			
<b>Electronic releases, terminal screws standard, Box terminals as accessories</b>						
630		315-630	1260-5040			
630		315-630	1260-5040			
800		400-800	1600-9600			
800		400-800	1600-9600			
1000		500-1000	2000-12000			
1000		500-1000	2000-12000			
1250		630-1250	2500-15000			
1250		630-1250	2500-15000			
1600		800-1600	3200-19200			
1600		800-1600	3200-19200			

1) Applies for NZM1  
 2) applies for NZM2 and NZM3  
 3) 60% release on neutral pole

Circuit-breaker with basic switching capacity 25 kA at 415 V 50/60 Hz		Circuit-breaker with Comfort switching capacity 36 kA at 415 V 50/60 Hz		Circuit-breaker with Normal switching capacity 50 kA at 415 V 50/60 Hz		Circuit-breaker with High switching capacity 100 <sup>1)</sup> /150 <sup>2)</sup> kA at 415 V 50/60 Hz	
Part No.	Part No.	Part No.	Part No.	Part No.	Part No.	Part No.	Part No.
3-pole	4-pole	3-pole	4-pole	3-pole	4-pole	3-pole	4-pole
-	-	MZMC1-A20	NZMC1-4-A20	NZMN1-A20	NZMN1-4-A20	NZMH1-A20	NZMH1-4-A20
NZMB1-A20	NZMB1-4-A20	NZMC1-A25	NZMC1-4-A25	NZMN1-A25	NZMN1-4-A25	NZMH1-A25	NZMH1-4-A25
NZMB1-A25	NZMB1-4-A25	NZMC1-A32	NZMC1-4-A32	NZMN1-A32	NZMN1-4-A32	NZMH1-A32	NZMH1-4-A32
NZMB1-A32	NZMB1-4-A32	NZMC1-A40	NZMC1-4-A40	NZMN1-A40	NZMN1-4-A40	NZMH1-A40	NZMH1-4-A40
NZMB1-A40	NZMB1-4-A40	NZMC1-A50	NZMC1-4-A50	NZMN1-A50	NZMN1-4-A50	NZMH1-A50	NZMH1-4-A50
NZMB1-A50	NZMB1-4-A50	NZMC1-A63	NZMC1-4-A63	NZMN1-A63	NZMN1-4-A63	NZMH1-A63	NZMH1-4-A63
NZMB1-A63	NZMB1-4-A63	NZMC1-A80	NZMC1-4-A80	NZMN1-A80	NZMN1-4-A80	NZMH1-A80	NZMH1-4-A80
NZMB1-A80	NZMB1-4-A80	NZMC1-A100	NZMC1-4-A100	NZMN1-A100	NZMN1-4-A100	NZMH1-A100	NZMH1-4-A100
NZMB1-A100	NZMB1-4-A100	NZMC1-A125	NZMC1-4-A125	NZMN1-A125	NZMN1-4-A125	NZMH1-A125	NZMH1-4-A125
NZMB1-A125	NZMB1-4-A125	NZMC1-A160	NZMC1-4-A160	NZMN1-A160	NZMN1-4-A160	NZMH1-A160	NZMH1-4-A160
NZMB1-A160	NZMB1-4-A160						
-	-	-	-	-	-	NZMH2-A20	NZMH2-4-A20
-	-	-	-	-	-	NZMH2-A25	NZMH2-4-A25
-	-	-	-	-	-	NZMH2-A32	NZMH2-4-A32
-	-	-	-	-	-	NZMH2-A40	NZMH2-4-A40
-	-	-	-	-	-	NZMH2-A50	NZMH2-4-A50
-	-	-	-	-	-	NZMH2-A63	NZMH2-4-A63
-	-	-	-	-	-	NZMH2-A80	NZMH2-4-A80
-	-	-	-	-	-	NZMH2-A100	NZMH2-4-A100
-	-	-	-	-	-	NZMH2-A125	NZMH2-4-A125
NZMB2-A160	NZMB2-4-A160	NZMC2-A160	NZMC2-4-A160	NZMN2-A160	NZMN2-4-A160	NZMH2-A160	NZMH2-4-A160
-	NZMB2-4-A160/100 <sup>3)</sup>	-	NZMC2-4-A160/100 <sup>3)</sup>	-	NZMN2-4-A160/100 <sup>3)</sup>	-	NZMH2-4-A160/100 <sup>3)</sup>
NZMB2-A200	NZMB2-4-A200	NZMC2-A200	NZMC2-4-A200	NZMN2-A200	NZMN2-4-A200	NZMH2-A200	NZMH2-4-A200
-	NZMB2-4-A200/125 <sup>3)</sup>	-	NZMC2-4-A200/125 <sup>3)</sup>	-	NZMN2-4-A200/125 <sup>3)</sup>	-	NZMH2-4-A200/125 <sup>3)</sup>
NZMB2-A250	NZMB2-4-A250	NZMC2-A250	NZMC2-4-A250	NZMN2-A250	NZMN2-4-A250	NZMH2-A250	NZMH2-4-A250
-	NZMB2-4-A250/160 <sup>3)</sup>	-	NZMC2-4-A250/160 <sup>3)</sup>	-	NZMN2-4-A250/160 <sup>3)</sup>	-	NZMH2-4-A250/160 <sup>3)</sup>
NZMB2-A300	NZMB2-4-A300	NZMC2-A300	NZMC2-4-A300	NZMN2-A300	NZMN2-4-A300	NZMH2-A300	NZMH2-4-A300
-	NZMB2-4-A300/200 <sup>3)</sup>	-	NZMC2-4-A300/200 <sup>3)</sup>	-	NZMN2-4-A300/200 <sup>3)</sup>	-	NZMH2-4-A300/200 <sup>3)</sup>
-	-	-	-	-	-	NZMH2-A20-BT	-
-	-	-	-	-	-	NZMH2-A25-BT	-
-	-	-	-	-	-	NZMH2-A32-BT	-
-	-	-	-	-	-	NZMH2-A40-BT	-
-	-	-	-	-	-	NZMH2-A50-BT	-
-	-	-	-	-	-	NZMH2-A63-BT	-
-	-	-	-	-	-	NZMH2-A80-BT	-
-	-	-	-	-	-	NZMH2-A100-BT	-
-	-	-	-	-	-	NZMH2-A125-BT	-
NZMB2-A160-BT	-	NZMC2-A160-BT	-	NZMN2-A160-BT	-	NZMH2-A160-BT	-
NZMB2-A200-BT	-	NZMC2-A200-BT	-	NZMN2-A200-BT	-	NZMH2-A200-BT	-
NZMB2-A250-BT	-	NZMC2-A250-BT	-	NZMN2-A250-BT	-	NZMH2-A250-BT	-
NZMB2-A300-BT	-	NZMC2-A300-BT	-	NZMN2-A300-BT	-	NZMH2-A300-BT	-
-	-	NZMC3-A320	NZMC3-4-A320	NZMN3-A320	NZMN3-4-A320	NZMH3-A320	NZMH3-4-A320
-	-	-	NZMC3-4-A320/200 <sup>3)</sup>	-	NZMN3-4-A320/200 <sup>3)</sup>	-	NZMH3-4-A320/200 <sup>3)</sup>
-	-	NZMC3-A400	NZMC3-4-A400	NZMN3-A400	NZMN3-4-A400	NZMH3-A400	NZMH3-4-A400
-	-	-	NZMC3-4-A400/250 <sup>3)</sup>	-	NZMN3-4-A400/250 <sup>3)</sup>	-	NZMH3-4-A400/250 <sup>3)</sup>
-	-	NZMC3-A500	NZMC3-4-A500	NZMN3-A500	NZMN3-4-A500	NZMH3-A500	NZMH3-4-A500
-	-	-	NZMC3-4-A500/320 <sup>3)</sup>	-	NZMN3-4-A500/320 <sup>3)</sup>	-	NZMH3-4-A500/320 <sup>3)</sup>
-	-	NZMC3-A320-BT	-	NZMN3-A320-BT	-	NZMH3-A320-BT	-
-	-	NZMC3-A400-BT	-	NZMN3-A400-BT	-	NZMH3-A400-BT	-
-	-	NZMC3-A500-BT	-	NZMN3-A500-BT	-	NZMH3-A500-BT	-
-	-	-	-	NZMN3-AE630	NZMN3-4-AE630	NZMH3-AE630	NZMH3-4-AE630
-	-	-	-	-	NZMN3-4-AE630/400	-	NZMH3-4-AE630/400
-	-	-	-	NZMN4-AE800	NZMN4-4-AE800	NZMH4-AE800	NZMH4-4-AE800
-	-	-	-	-	NZMN4-4-AE800/500	-	NZMH4-4-AE800/500
-	-	-	-	NZMN4-AE1000	NZMN4-4-AE1000	NZMH4-AE1000	NZMH4-4-AE1000
-	-	-	-	-	NZMN4-4-AE1000/630	-	NZMH4-4-AE1000/630
-	-	-	-	NZMN4-AE1250	NZMN4-4-AE1250	NZMH4-AE1250	NZMH4-4-AE1250
-	-	-	-	-	NZMN4-4-AE1250/800	-	NZMH4-4-AE1250/800
-	-	-	-	NZMN4-AE1600	NZMN4-4-AE1600	NZMH4-AE1600	NZMH4-4-AE1600
-	-	-	-	-	NZMN4-4-AE1600/1000	-	NZMH4-4-AE1600/1000



UL 489

Circuit-breaker			
Rated current = Rated uninterrupted current		Setting ranges of the release	
	$I_n = I_u$	$I_r$	$I_i$
	<b>A</b>	<b>A</b>	<b>A</b>
<b>Distribution circuit and line protection</b>			
 Terminals standard Terminal screws as accessories	15	15	350
	20	20	350
	25	25	350
	30	30	350
	35	35	320 - 400
	40	40	320 - 400
	45	45	300 - 500
	50	50	300 - 500
	60	60	380 - 630
	70	70	480 - 800
	80	80	480 - 800
	90	90	600 - 1000
	100	100	600 - 1000
	110	110	750 - 1250
	125	125	750 - 1250
	150	150	960 - 1600
	 Standard terminal screws Terminals as accessories	175	175
200		200	1200 - 2000
225		225	1500 - 2500
250		250	1500 - 2500
300		300	600 - 3300
350		350	700 - 3850
400		400	800 - 4400
450		450	900 - 3600
500		500	1000 - 4000
550		550	1100 - 4400
600		600	1200 - 4800
700		700	1400 - 8400
800	800	1600 - 9600	
900	900	1800 - 10800	
1000	1000	2000 - 12000	
1200	1200	2400 - 14400	
<b>Motor protection in conjunction with contactors and overload relays with short-circuit releases without overload release</b>			
 Terminals standard Terminal screws as accessories	1.2	—	8 - 14
	2	—	12.8 - 22.4
	3	—	19.2 - 33.6
	5	—	32 - 56
	8	—	48 - 84
	12	—	80 - 140
	18	—	128 - 224
	26	—	200 - 350
	33	—	256 - 448
	40	—	320 - 560
	50	—	400 - 700
	63	—	504 - 882
	80	—	640 - 1120
	100	—	800 - 1250
	125	—	1000 - 1750
	160	—	1280 - 2240
	 Standard terminal screws Terminals as accessories	200	—
250		—	2000 - 2500







3-pole		
Switching capacity		
Basic 25 kA 480 V 60 Hz 18 kA 600 V 60 Hz	Standard 35/42 kA 480 V 60 Hz 25/35 kA 600 V 60 Hz	High 85/100kA 480V 60 Hz 50kA 600V 60 Hz
NZMB1-AF15-NA NZMB1-AF20-NA NZMB1-AF25-NA NZMB1-AF30-NA NZMB1-AF35-NA NZMB1-AF40-NA NZMB1-AF45-NA NZMB1-AF50-NA NZMB1-AF60-NA NZMB1-AF70-NA NZMB1-AF80-NA NZMB1-AF90-NA NZMB1-AF100-NA NZMB1-AF110-NA NZMB1-AF125-NA NZMB2-AF150-NA NZMB2-AF175-NA NZMB2-AF200-NA NZMB2-AF225-NA NZMB2-AF250-NA – – – – – – – – – – –	NZMN1-AF15-NA NZMN1-AF20-NA NZMN1-AF25-NA NZMN1-AF30-NA NZMN1-AF35-NA NZMN1-AF40-NA NZMN1-AF45-NA NZMN1-AF50-NA NZMN1-AF60-NA NZMN1-AF70-NA NZMN1-AF80-NA NZMN1-AF90-NA NZMN1-AF100-NA NZMN1-AF110-NA NZMN1-AF125-NA NZMN2-AF150-NA NZMN2-AF175-NA NZMN2-AF200-NA NZMN2-AF225-NA NZMN2-AF250-NA NZMN3-AEF300-NA NZMN3-AEF350-NA NZMN3-AEF400-NA NZMN3-AEF450-NA NZMN3-AEF500-NA NZMN3-AEF550-NA NZMN3-AEF600-NA NZMN4-AEF700-NA NZMN4-AEF800-NA NZMN4-AEF900-NA NZMN4-AEF1000-NA NZMN4-AEF1200-NA	NZMH2-AF15-NA NZMH2-AF20-NA NZMH2-AF25-NA NZMH2-AF30-NA NZMH2-AF35-NA NZMH2-AF40-NA NZMH2-AF45-NA NZMH2-AF50-NA NZMH2-AF60-NA NZMH2-AF70-NA NZMH2-AF80-NA NZMH2-AF90-NA NZMH2-AF100-NA NZMH2-AF110-NA NZMH2-AF125-NA NZMH2-AF150-NA NZMH2-AF175-NA NZMH2-AF200-NA NZMH2-AF225-NA NZMH2-AF250-NA NZMH3-AEF300-NA NZMH3-AEF350-NA NZMH3-AEF400-NA NZMH3-AEF450-NA NZMH3-AEF500-NA NZMH3-AEF550-NA NZMH3-AEF600-NA NZMH4-AEF700-NA NZMH4-AEF800-NA NZMH4-AEF900-NA NZMH4-AEF1000-NA NZMH4-AEF1200-NA
NZMB1-S1,2-CNA NZMB1-S2-CNA NZMB1-S3-CNA NZMB1-S5-CNA NZMB1-S8-CNA NZMB1-S12-CNA NZMB1-S18-CNA NZMB1-S26-CNA NZMB1-S33-CNA NZMB1-S40-CNA NZMB1-S50-CNA NZMB1-S63-CNA NZMB1-S80-CNA NZMB1-S100-CNA NZMB2-S125-CNA NZMB2-S160-CNA NZMB2-S200-CNA NZMB2-S250-CNA	NZMN1-S1,2-CNA NZMN1-S2-CNA NZMN1-S3-CNA NZMN1-S5-CNA NZMN1-S8-CNA NZMN1-S12-CNA NZMN1-S18-CNA NZMN1-S26-CNA NZMN1-S33-CNA NZMN1-S40-CNA NZMN1-S50-CNA NZMN1-S63-CNA NZMN1-S80-CNA NZMN1-S100-CNA NZMN2-S125-CNA NZMN2-S160-CNA NZMN2-S200-CNA NZMN2-S250-CNA	– – – – – – – – – – – – – – – –



Auxiliary contacts					
Version	For use with	Max. number of auxiliary contacts per switch	Contacts		Part no.
			N/O = Normally open N/C = Normally closed		
<p><b>Standard auxiliary contact (HIN)</b> Switching with the main contacts Used for indicating and interlocking tasks</p>  <p>With bolt connection</p> <p>With cage clamp connection.</p>	<p>NZM1(-4), 2(-4), 3(-4), 4(-4) PN1(-4), 2(-4), 3(-4) N(S)1(-4), 2(-4), 3(-4), 4(-4)</p> <p>NZM1(-4), 2(-4), 3(-4), 4(-4) PN1(-4), 2(-4), 3(-4) N(S)1(-4), 2(-4), 3(-4), 4(-4)</p>	<p>N(S)1, PN1, NZM1: 1 N(S)2, PN2, NZM2: 2 N(S)3, PN3, NZM3: 3 N(S)4, NZM4: 3</p>	<p>1 N/O – – 1 N/C</p> <p>1 N/O 1 N/C 2 N/O – – 2 N/C</p>	<p><b>M22-K10</b> <b>M22-K01</b></p> <p><b>M22-CK11</b> <b>M22-CK20</b> <b>M22-CK02</b></p>	
<p><b>Early-make auxiliary contacts</b> For interlock and load-shedding circuits, as well as for early-make switching of the undervoltage release with main switch / emergency-Stop applications</p> <p>With clamp terminal on the left-hand switch side.</p> <p>With clamp terminal on the right-hand switch side.</p> <p>With 3 m connecting cables instead of bolt connection.</p> <p>With bolt connection</p> 	<p>NZM1(-4) PN1(-4) N(S)1(-4)</p> <p>NZM1(-4) PN1(-4) N(S)1(-4)</p> <p>NZM1(-4) PN1(-4) N(S)1(-4)</p> <p>NZM2(-4), 3(-4) PN2(-4), 3(-4) N(S)2(-4), 3(-4)</p> <p>NZM4(-4) N(S)4(-4)</p>	<p>N(S)1, NZM1: 1 N(S)2, NZM2: 1 N(S)3, NZM3: 1 N(S)4, NZM4: 2</p>	<p>2 N/O –</p> <p>2 N/O –</p> <p>2 N/O –</p> <p>2 N/O –</p> <p>2 N/O –</p>	<p><b>NZM1-XHIV</b></p> <p><b>NZM1-XHIVR</b></p> <p><b>NZM1-XHIVL</b></p> <p><b>NZM2/3-XHIV</b></p> <p><b>NZM4-XHIV</b></p>	
<p><b>Trip indicating auxiliary contact (HIA)<sup>1)</sup></b> General trip indication "+" with trip by voltage release, overload release or short-circuit release</p>  <p>With bolt connection</p> <p>With cage clamp connection.</p>	<p>NZM1(-4), 2(-4), 3(-4), 4(-4) N(S)1(-4), 2(-4), 3(-4), 4(-4)</p> <p>NZM1(-4), 2(-4), 3(-4), 4(-4) N(S)1(-4), 2(-4), 3(-4), 4(-4)</p>		<p>1 N/O – – 1 N/C</p> <p>1 N/O 1 N/C 2 N/O – – 2 N/C</p>	<p><b>M22-K10</b> <b>M22-K01</b></p> <p><b>M22-CK11</b> <b>M22-CK20</b> <b>M22-CK02</b></p>	

<sup>1)</sup> not in conjunction with switch-disconnector PN



Release		Undervoltage release <sup>1)</sup>		Overvoltage release <sup>2)</sup>	
Version	For use with	Without auxiliary contact		Without auxiliary contact	
		Rated control voltage $U_s$ V	Part no.	Rated control voltage $U_s$ V	Part no.
With clamp terminal on the left-hand switch side. 	NZM1(-4), N(S)1(-4)	24 V 50/60 Hz 110 V – 130 V 50/60 Hz 208 V – 240 V 50/60 Hz 380 V – 440 V 50/60 Hz 12 V DC 24 V DC 110 V – 130 V DC 220 V – 250 V DC	<b>NZM1-XU24AC</b> <b>NZM1-XU110-130AC</b> <b>NZM1-XU208-240AC</b> <b>NZM1-XU380-440AC</b> <b>NZM1-XU12DC</b> <b>NZM1-XU24DC</b> <b>NZM1-XU110-130DC</b> <b>NZM1-XU220-250DC</b>	12 V AC/DC 24 V AC/DC 110 V – 130 V AC/DC 208 V – 250 V AC/DC 380 V – 440 V AC/DC	<b>NZM1-XA12AC/DC</b> <b>NZM1-XA24AC/DC</b> <b>NZM1-XA110-130AC/DC</b> <b>NZM1-XA208-250AC/DC</b> <b>NZM1-XA380-440AC/DC</b>
With 3 m connection cable instead of screw termination. 	NZM1(-4), N(S)1(-4)	24 V 50/60 Hz 110 V – 130 V 50/60 Hz 208 V – 240 V 50/60 Hz 380 V – 440 V 50/60 Hz 12 V DC 24 V DC 110 V – 130 V DC 220 V – 250 V DC	<b>NZM1-XUL24AC</b> <b>NZM1-XUL110-130AC</b> <b>NZM1-XUL208-240AC</b> <b>NZM1-XUL380-440AC</b> <b>NZM1-XUL12DC</b> <b>NZM1-XUL24DC</b> <b>NZM1-XUL110-130DC</b> <b>NZM1-XUL220-250DC</b>	12 V AC/DC 24 V AC/DC 110 V – 130 V AC/DC 208 V – 250 V AC/DC 380 V – 440 V AC/DC	<b>NZM1-XAL12AC/DC</b> <b>NZM1-XAL24AC/DC</b> <b>NZM1-XAL110-130AC/DC</b> <b>NZM1-XAL208-250AC/DC</b> <b>NZM1-XAL380-440AC/DC</b>
With clamp-type terminals 	NZM2(-4), N2(-4), NZM3(-4) N(S)3(-4)	24 V 50/60 Hz 110 V – 130 V 50/60 Hz 208 V – 240 V 50/60 Hz 380 V – 440 V 50/60 Hz 12 V DC 24 V DC 110 V – 130 V DC 220 V – 250 V DC	<b>NZM2/3-XU24AC</b> <b>NZM2/3-XU110-130AC</b> <b>NZM2/3-XU208-240AC</b> <b>NZM2/3-XU380-440AC</b> <b>NZM2/3-XU12DC</b> <b>NZM2/3-XU24DC</b> <b>NZM2/3-XU110-130DC</b> <b>NZM2/3-XU220-250DC</b>	12 V AC/DC 24 V AC/DC 110 V – 130 V AC/DC 208 V – 250 V AC/DC 380 V – 440 V AC/DC	<b>NZM2/3-XA12AC/DC</b> <b>NZM2/3-XA24AC/DC</b> <b>NZM2/3-XA110-130AC/DC</b> <b>NZM2/3-XA208-250AC/DC</b> <b>NZM2/3-XA380-440AC/DC</b>
With clamp-type terminals 	NZM4(-4), N(S)4(-4)	24 V 50/60 Hz 110 V – 130 V 50/60 Hz 208 V – 240 V 50/60 Hz 380 V – 440 V 50/60 Hz 12 V DC 24 V DC 110 V – 130 V DC 220 V – 250 V DC	<b>NZM4-XU24AC</b> <b>NZM4-XU110-130AC</b> <b>NZM4-XU208-240AC</b> <b>NZM4-XU380-440AC</b> <b>NZM4-XU12DC</b> <b>NZM4-XU24DC</b> <b>NZM4-XU110-130DC</b> <b>NZM4-XU220-250DC</b>	12 V AC/DC 24 V AC/DC 110 V – 130 V AC/DC 208 V – 250 V AC/DC 380 V – 440 V AC/DC	<b>NZM4-XA12AC/DC</b> <b>NZM4-XA24AC/DC</b> <b>NZM4-XA110-130AC/DC</b> <b>NZM4-XA208-250AC/DC</b> <b>NZM4-XA380-440AC/DC</b>

<sup>1)</sup> non-delayed shut down of circuit-breaker NZM or switch-disconnector N with drop of the control voltage below 35 – 70%  $U_s$ .  
For use with Emergency-Stop devices in conjunction with Emergency-Stop button.

<sup>2)</sup> switches are tripped by a voltage pulse or by the application of uninterrupted voltage



Door coupling rotary handles		
Version	For use with	Part no.
<p><b>Door coupling rotary handle</b> Complete including rotary drive and coupling parts With the NZM...-XTVD... as well as NZM...-XTVD...60 types, an additional extension shaft is required. Degree of protection IP66/NEMA 4X Standard, black/grey</p> 	<p>NZM1(-4), PN1(-4), N(S)1(-4) NZM2(-4), PN2(-4), N(S)2(-4) NZM3(-4), PN3(-4), N(S)3(-4) NZM4(-4), N(S)4(-4)</p>	<p><b>NZM1-XTVD</b> <b>NZM2-XTVD</b> <b>NZM3-XTVD</b> <b>NZM4-XTVD</b></p>
<p>Lockable on handle and switch. Can be locked in 0 position, with adequate modification also in I position. Lockable door as additional feature, locking facility on circuit-breaker in 0 position.</p> 	<p>NZM1(-4), PN1(-4), N(S)1(-4) NZM2(-4), PN2(-4), N(S)2(-4)</p> <p>NZM3(-4), PN3(-4), N(S)3(-4) NZM4(-4), N(S)4(-4)</p>	<p><b>NZM1-XTVDV</b> <b>NZM2-XTVDV</b></p> <p><b>NZM3-XTVDV</b> <b>NZM4-XTVDV</b></p>
<p>Red-yellow for Emergency-Stop Lockable on handle and switch. Can be locked in 0 position, with adequate modification also in I position. Lockable door as additional feature, locking facility on circuit-breaker in 0 position.</p> 	<p>NZM1(-4), PN1(-4), N(S)1(-4) NZM2(-4), PN2(-4), N(S)2(-4)</p> <p>NZM3(-4), PN3(-4), N(S)3(-4)</p> <p>NZM4(-4), N(S)4(-4)</p>	<p><b>NZM1-XTVDVR</b> <b>NZM2-XTVDVR</b></p> <p><b>NZM3-XTVDVR</b> <b>NZM4-XTVDVR</b></p>
<p><b>Extension shaft</b> 400 mm Max. mounting depth</p>  <p>600 mm Max. mounting depth</p>	<p>NZM1(-4), PN1(-4), N(S)1(-4) NZM2(-4), PN2(-4), N(S)2(-4) NZM3(-4), PN3(-4), N(S)3(-4) NZM4(-4), N(S)4(-4)</p> <p>NZM1(-4), PN1(-4), N(S)1(-4) NZM2(-4), PN2(-4), N(S)2(-4) NZM3(-4), PN3(-4), N(S)3(-4) NZM4(-4), N(S)4(-4)</p>	<p><b>NZM1/2-XV4</b> <b>NZM3/4-XV4</b></p> <p><b>NZM1/2-XV6</b> <b>NZM3/4-XV6</b></p>
<p><b>Toggle lever locking facilities</b></p> 	<p>NZM1-1 NZM1(-4), PN2(-4), N(S)1(-4) NZM2/3(-4), PN2/3(-4), N(S)2/3(-4)</p>	<p><b>NZM1-1-XKAV</b> <b>NZM1-XKAV</b> <b>NZM2/3-XKAV</b></p>

### Connection types



	For use with	Conductor type	Conductor cross-section (applies for 3-pole and 4-pole switches)				Part no.  O=fitted at top U=fitted at bottom
			mm <sup>2</sup>	AWG/kcmil	Cu-Band mm	Copper strip mm	
	<b>Box terminal</b> NZM2, PN2, N(S)2 3-pole ≤ 160 A NZM2, PN2, N(S)2 200 A, 250 A  NZM2-4, PN2-4, N2-4 4-pole ≤ 160 A NZM2-4, PN2-4, N2-4 200 A, 250 A  max. 500 A, and 400 A UL/CSA NZM3, PN3, N(S)3 3-pole NZM3-4, PN3-4, N3-4 4-pole 630 A	Cu cables Cu cable       Cu cables Cu cable	1 x 4 – 185 2 x 4 – 70       1 x 35 – 240 2 x 16 – 120	1 x 12 – 350       1 x 2 – 500	f 2 x 9 x 0.8       min. 6 x 16 x 0.8 max. 10 x 24 x 1.0   10 x 24 x 1.0 + 5 x 24 x 1.0	+NZM2-160-XKCO +NZM2-160-XKCU +NZM2-250-XKCO +NZM2-250-XKCU   +NZM2-4-160-XKCO +NZM2-4-160-XKCU +NZM2-4-250-XKCO +NZM2-4-250-XKCU   +NZM3-XKCO +NZM3-XKCU +NZM3-4-XKCO +NZM3-4-XKCU	
	<b>Shroud</b> NZM1-1 1-pole NZM2, PN2, N(S)2 3-pole NZM3, PN3, N(S)3  NZM2-4, PN2-4, N2-4 4-pole NZM3-4, PN3-4, N3-4					NZM1-1-XKSA NZM2-XKSA NZM3-XKSA  NZM2-4-XKSA NZM3-4-XKSA	
	<b>Screw terminal</b> Standard equipment max. 1250 A NZM4, N(S)4 3- and NZM4-4, N4-4) 4-pole 1600 A	Cu lugs	1 x 120 – 185 4 x 50 – 185	1 x 250 – 350 4 x 0 – 350	(2 x) 10 x 50 x 1.0	(2 x) 50 x 10	
	<b>Module plate</b> max. 1250A 1-hole NZM4, N(S)4 3-pole NZM4-4, N4-4 4-pole  max. 1400A 2-hole NZM4, N(S)4 3-pole NZM4-4, N4-4 4-pole  max. 1500A	Cu lugs   Cu lugs	1 x 120 – 300 2 x 95 – 300  2 x 95 – 185 4 x 35 – 185	1 x 250 – 600 2 x 000 – 600  2 x 000 – 350 4 x 2 – 350	(2 x) 10 x 40 x 1.0 (2 x) 10 x 50 x 1.0   (2 x) 10 x 50 x 1.0	(2 x) 40 x 10 (2 x) 50 x 10   (2 x) 50 x 10	NZM4-XKM1 NZM4-4-XKM1  NZM4-XKM2 NZM4-4-XKM2
	<b>Module plate</b> max. 1250A 2-hole NZM4, N(S)4 3-pole NZM4-4, N4-4 4-pole  1600A 2-hole NZM4, N(S)4 3-pole NZM4-4, N4-4 4-pole	Cu lugs	2 x 95 – 300	2 x 000 – 600	(2 x) 10 x 50 x 1.0	(2 x) 50 x 10	NZM4-XKM2S-1250 NZM4-4-XKM2S-1250  NZM4-XKM2S-1600 NZM4-4-XKM2S-1600
	<b>Connection width extension</b> 630 A NZM3, PN3, N(S)3 3-pole NZM3-4, PN3-4, N3-4 4-pole 1600 A NZM4, N(S)4 3-pole NZM4-4, N4-4 4-pole	Cu-lugs Al lugs  Cu lugs	2 x 300  4 x 300 6 x 95 – 240	2 x 500  4 x 600 6 x 000 – 500	(2 x) 10 x 50 x 1.0  max. (2 x) 10 x 80 x 1.0	(2 x) 10 x 50  max. (2 x) 80 x 10	NZM3-XKV70 NZM3-4-XKV70  NZM4-XKV95 NZM4-4-XKV110 NZM4-4-XKV95 NZM4-4-XKV120



# Residual-current protection module up to 250 A rated current



The residual-current protection modules can be connected to the bottom of the circuit-breaker NZM1 and NZM2, and on the NZM1 also on the right hand side with the same contour design. A compact and mounting-friendly solution. An external auxiliary voltage is not required. The residual-current protection module of the NZM2 is independent of the mains voltage and can thus be used for personnel protection in Germany. It is available in pulse current sensitive and also in AC/DC current sensitive devices. In almost every mains configuration 3-pole and 4-pole variants as well as rated fault currents from 30 mA to time-discriminating 3 A are on offer.

During a fault the rising fault current will initially be indicated by an LED on the RCCB for the NZM1. The circuit-breaker trips via the residual-current release only after the set fault current is exceeded, i.e. the main contacts will be opened. The cause of the fault is indicated mechanically on the device with the NZM1 and 2. Optional auxiliary contacts can be clipped on in order to remotely indicate the trip. The circuit-breaker and the residual-current release must be reset and switched back on in order to restore the power supply.

Fault current trip			3-pole	4-pole
Version	Rated uninterrupted current	Rated fault current delay time	Part no.	Part no.
<b>Pulse current sensitive</b>	Mounted at side	max 160A	<b>NZM1-XFI30R</b>	<b>NZM1-4-XFI30R</b>
	Mounted at bottom	max 100A		
	Mounted at side	max 160A	<b>NZM1-XFI30U</b>	<b>NZM1-4-XFI30U</b>
	Mounted at bottom	max 100A		
	Mounted at side	max 160A	<b>NZM1-XFI300R</b>	<b>NZM1-4-XFI300R</b>
	Mounted at bottom	max 100A		
Mounted at bottom	max 250A	<b>NZM1-XFI300U</b>	<b>NZM1-4-XFI300U</b>	
Mounted at bottom	max 250A			
<b>AC/DC sensitive</b>			<b>NZM1-XFIR</b>	<b>NZM1-4-XFIR</b>
			<b>NZM1-XFIU</b>	<b>NZM1-4-XFIU</b>
			-	<b>NZM2-4-XFI30</b>
			-	<b>NZM2-4-XFI</b>
			-	<b>NZM2-4-XFIA30</b>
			-	<b>NZM2-4-XFIA</b>

# NZM 2 with RCCB module for welding applications



- Suitable for use in three-phase systems
- Rated operational voltage 400V/ 50/60 Hz
- Rated fault current  $I_n = 0.03 A$
- Built-in power supply  $U_e = 50 - 400 V$
- Pulse current sensitive
- Non-UL/CSA approved

The 3-pole circuit-breaker with residual-current release for equipment with power electronics such as inverters and frequency inverters is particularly suitable for welding applications. The RCCB module is pulse current sensitive and operates according to the core-balance principle in a range from 0–100 kHz. Unwanted trips due to transient, pulse-shaped errors of the operating current are prevented. The function is mains voltage independent.

Circuit-breaker with residual-current release			
Rated current = rated uninterrupted current $I_n = I_u$ A	Overload release $I_r$ A 	Short-circuit release $I_i$ A 	<b>Part no.</b> Typical high switching capacity 150 kA at 415 V 50/60 Hz
160	125...160	960...1600	<b>NZMH2-A160-FIA30</b>
200	160...200	1200...2000	<b>NZMH2-A200-FIA30</b>
250	200...250	1500...2500	<b>NZMH2-A250-FIA30</b>

## Circuit-breakers for applications up to 1000 V AC



The special series for up to 1000 V 50Hz rated operational voltage further extends the area of application for circuit-breakers and switch-disconnectors. They are particularly suitable for use under special environmental conditions such as mines, street tunnels, refineries, chemical plants and electric railways. Typical applications include higher power drives and general industrial power supply with long power lines.

Circuit-breaker 3-pole for 1000 V AC									
With main switch characteristics to IEC/EN 60204 and isolating characteristics to IEC/EN 60947, VDE 660									
Switching capacity	Protection of systems and cables			Selectively-opening circuit-breakers			Motor protection		
1000 V kA/cos φ $I_{cu}$ rated uninterrupted current $I_u = \text{rated current } I_n$ ambient temperature at 100% $I_u$ min./max. -25 / +50	10 / 0.5 $I_u$ <b>A</b>	15 / 0.5 $I_u$ <b>A</b>	20 / 0.3 $I_u$ <b>A</b>	10 / 0.5 $I_u$ <b>A</b>	15 / 0.5 $I_u$ <b>A</b>	20 / 0.3 $I_u$ <b>A</b>	15 / 0.5 $I_u$ <b>A</b>	20 / 0.3 $I_u$ <b>A</b>	
	<b>NZMH2-A...S1</b> 20 - 300	<b>NZMH3-AE...S1</b> 250 - 630	<b>NZMH4-AE...S1</b> 630 - 1600	<b>NZMH2-VE...S1</b> 100 - 250	<b>NZMH3-VE...S1</b> 400 - 630	<b>NZMH4-VE...S1</b> 630 - 1600	<b>NZMH3-ME...S1</b> 220 - 450	<b>NZMH4-ME...S1</b> 550 - 1400	

# Flexible fault current protection up to 1800 A current rating



## Protection against the dangers of electrical energy with insulation faults

The new Eaton relay/transducer combination covers operating currents in a range from 1 to 1800 A. The wide spectrum of applications ranges from general power distribution tasks to individual motor controls. The fault currents which are detected and processed by the relay range from 30 mA to 5 A. The adjustable relay provides a pre-warn function which alerts before the set fault current is exceeded. The pre-warning allows preventative action to be taken to prevent shutdown of the electrical energy.

The application range of the relay/transducer combinations extend – depending on the regulations which apply – from personnel protection to fire protection, and even extends up to protection of systems for 1 to 4 pole power grids. The current relay signals that the set fault current has been exceeded with a changeover contact. Depending on the application, the contact signal can be subsequently processed in the controls, as well as by the shunt or undervoltage releases of a circuit-breaker which initiate the trip. The relay and transducer can be combined with every circuit-breaker. The compact ring-type transducer with no particular space requirement is placed at a suitable position on the cable run. The relay simply requires a free electrical cable connection.

**Compact, safe, adaptable ...**

... just as it should be, the fault current protection which is particularly suited for cramped spaces such as for example in service distribution systems.

Ring-type transducers which are arranged in a space saving manner on the cabling run and the measuring relay which is simply snapped onto the DIN mounting rail, combine to form a functional unit.

After a critical fault current has been exceeded, the output signal can be optionally channelled to an acoustic/optical signalling device, upstream control or directly to the shunt or undervoltage release of a motor-protective circuit-breaker/circuit-breaker for instantaneous shutdown.

Three different relay variants are available for different protective tasks: 30 mA as well as 300 mA sensitivity with a fixed setting and 30 mA to 5 A adjustable in fixed steps, which can be combined with a time delay of 20 ms to 5 s. The non-delayed standard devices are particularly suited for protection of systems. The time-delayed variants are intended for discriminative series connection of multiple switch/relay combinations. This ensures, that only the switch in the direct vicinity of the fault will trip.





**Two colour LED's signal operating and fault states**

Possible wiring faults between relay and transducers are indicated by illumination of both LED's. Diagnostics function with adjustable PFR-5 relay: If the set fault current is exceeded by more than 25, 50 or 75%, the red LED will flash at different frequencies. This alert feature ensures that trouble-shooting for the cause of the fault can commence before a critical state is reached.

**Two pushbuttons enable test and reset of the relay**

**Test:** The function of the relay electronics is tested and the trip signal can be used to control the shunt or undervoltage release of the connected circuit-breaker. This test checks the operation of the entire function chain comprised of measured value input, processing, signal routing as well as switch release.

**Reset:** The release signal is reset regardless of if it is received from a fault current or by operation of the test button.

Residual current relay with ring-type transducer			
		Part no.	
<b>Residual current relay</b> Pulse current sensitive 	Rated control voltage: $U_s = 230V$ A.C. (50/60 Hz) Integrated auxiliary switch (1 changeover contact)		
	Rated fault current $I_{\Delta n} = 0.03$ A	<b>PFR-003</b>	
	Rated fault current $I_{\Delta n} = 0.3$ A	<b>PFR-03</b>	
	Rated fault current $I_{\Delta n} = 0.03...5$ A Adjustable fault current and delay time  Fault current prewarning by flashing red LED	<b>PFR-5</b>	PFR-5: Adjustable fault current: 0.03 - 0.1 - 0.3 - 0.5 - 1 - 3 - 5 A  Adjustable delay time: 0.02 - 0.1 - 0.3 - 0.5 - 1 - 3 - 5 s
<b>Ring-type transducer</b> 	Internal diameter 20 mm	<b>PFR-W-20</b>	PFR-W-20 and PFR-W-30 incl. attachment clip for DIN top-hat rail
	Internal diameter 30 mm	<b>PFR-W-30</b>	
	Internal diameter 35 mm	<b>PFR-W-35</b>	PFR-W-35 and all larger transducers incl. screw fitting
	Internal diameter 70 mm	<b>PFR-W-70</b>	
	Internal diameter 105 mm	<b>PFR-W-105</b>	
	Internal diameter 140 mm	<b>PFR-W-140</b>	
	Internal diameter 210 mm	<b>PFR-W-210</b>	<b>Engineering note:</b> The transducer diameter must be selected to be 1.5 times larger than the diameter of the conductor lead through (see Technical Data).



## ➤ Quicklink

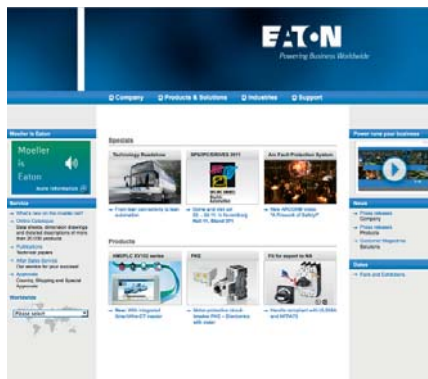

**Your goal's just a click away.**

1. All texts are provided with a 6-digit Quicklink number.

➤ Quicklink ID: ES XXXX

2. At [www.moeller.net](http://www.moeller.net) enter the required Quicklink number in the entry box at the top right or enter a search term and confirm.

3. This takes you immediately to extensive product information



*Powering Business Worldwide*

Eaton is dedicated to ensuring that reliable, efficient and safe power is available when it's needed most. With unparalleled knowledge of electrical power management across industries, experts at Eaton deliver customized, integrated solutions to solve our customers' most critical challenges.

Our focus is on delivering the right solution for the application. But, decision makers demand more than just innovative products. They turn to Eaton for an unwavering commitment to personal support that makes customer success a top priority.

For more information, visit [www.eaton.com/electrical](http://www.eaton.com/electrical).

Published by:  
Eaton Industries (Austria) GmbH  
Schedyergasse 42  
A-1215 Vienna

© 2011 by Eaton Industries (Austria) GmbH, Austria  
Subject to technical modifications.  
No responsibility is taken for misprints or errata.  
Printed in Austria (12/11)  
Graphic design: SRA, Schrems  
Printing: Rabl, Schrems  
W1230-7590GB  
Article No.: 110412

The products presented are part of the comprehensive Eaton offer.  
For more information, please contact your Eaton consultant.

**[www.eaton.com](http://www.eaton.com)**

