

ELSEMA 
WIRELESS COMMUNICATIONS

WIRELESS CONTROL
AT YOUR FINGERTIPS



ELSEMA CATALOGUE
2020/21

About Elsema

Elsema (Electronic Service and Manufacture) was established in 1973, and has since become a leader in its industry. With cutting edge innovations used to manufacture transmitters, receivers, gate and door automation technologies.

We have always been a privately owned Australian company. Thanks to the vision and dedication of its co-founder, Otto Eigner, Elsema grew from 4 employees in 1976 to employing over 40 in 2020.

We develop, manufacture and sell customer-orientated wireless solutions. As a supplier the company sets global standards in the field of licence-free communications and automation technology. Our manufacturing, research and developments are driven solely by individual requirements of our customers in our modern 1600 square metre factory located on a five acre site.

The Elsema products range from transmitters with one channel to sixteen channels, receivers, control cards for automated gates or garage doors, inductive loop detectors, antennas, power supplies, battery chargers and cases.

1 Year Warranty

Elsema's 1 year warranty is a clear statement to its customers that the highest possible standard has been used in sourcing components, manufacturing and design of its products. **The 1 year warranty applies to products designed and manufactured by Elsema and which are detailed in this catalogue.**

Our exclusive lifetime support on components and technical advice guarantees that we are there to service the product long after the sale. The lifetime support on components is for 12 years after the purchase date.

Contents

	Transmitter Selection Guide	Selection Guide	Page 3	
Elsema Receiver Selection Guide	Page 4-7			
	Waterproof PentaFOB® Series / PentaCODE® Series 433MHz Keyring Remotes		Keyring Remotes	Page 8-15
	Penta Series Receivers and Repeater / Booster for PentaFOB® / PentaCODE® Remotes	Penta Series		Page 16-25
	151MHz Transmitters Hand-held Transmitter		FMT151 series	151MHz Transmitters and Receivers
	151MHz Transmitters High Powered Transmitters	FMT151 series	Page 27	
	151MHz Receivers FM Receiver with Relay Output and Open Collectors	FMR151 series	Page 28-35	
	151MHz Analog Receivers 4-20 mA Analog Receivers	RXA151 series	151MHz Analog Transmitters and Receivers	
	151MHz Analog Transmitters 4-20 mA Analog Transmitter	TXA151 series		Page 37
	433MHz Transmitters Hand-held Gigalink® Transmitters	GLT433 series	433MHz Transmitters and Receivers	Page 38-39
	433MHz Transmitters High Powered Gigalink® Transmitters	GLT433 series		Page 40
	433MHz Receivers Receivers with Relay Outputs and Open collectors	GLR433 series		Page 41-51
	915 to 928MHz Transmitters Hand-held FFH Transmitters	MCT Transmitter	915 to 928MHz Transmitters and Receivers	Page 52-53
	915 to 928MHz Receivers Receivers with Relay Outputs and Open collectors	MCR915 series		Page 54-65

Contents

	G-2025: GSM Gate Opener		GSM Controllers	GSM Controllers	Page 66
	High Efficiency 5, 10, 20, 40 and 60 Watt Solar Panels		Solar Panels		Solar Panels
	Antennas, Effect of VSWR on Transmitted Power Coaxial Data Cable		Antennas	Antennas	Page 68-70
	150 to 153MHz Antennas		151MHz series		Page 71-74
	430 to 440MHz Antennas		433MHz series		Page 75-79
	900 to 930MHz Antennas		915MHz series		Page 80-84
	Antenna accessories and options		Antenna accessories and options		Page 85
	3 Volt, 6 Volt, 9 Volt, 12 Volt Alkaline & Rechargeable Batteries & Battery Chargers		Batteries / Battery Charger	Other	Page 86-87
	Flashing Lights for Outdoor Applications. Amber, Red, Blue & Green Colours. 90° Wall Mount Version.		Flasher Lights		Page 88
	1, 8, 12 and 16 Channel Aux Relay Cards		Relay cards		Page 89
	RelayH1-12, RelayH1-24, RelayH2-12 and RelayH2-24		Relay H1 & H2		Page 90
	IP66 Rated Plastic Cases with Metal Base Plates		Plastic cases		Page 91-93

Transmitter Selection Guide

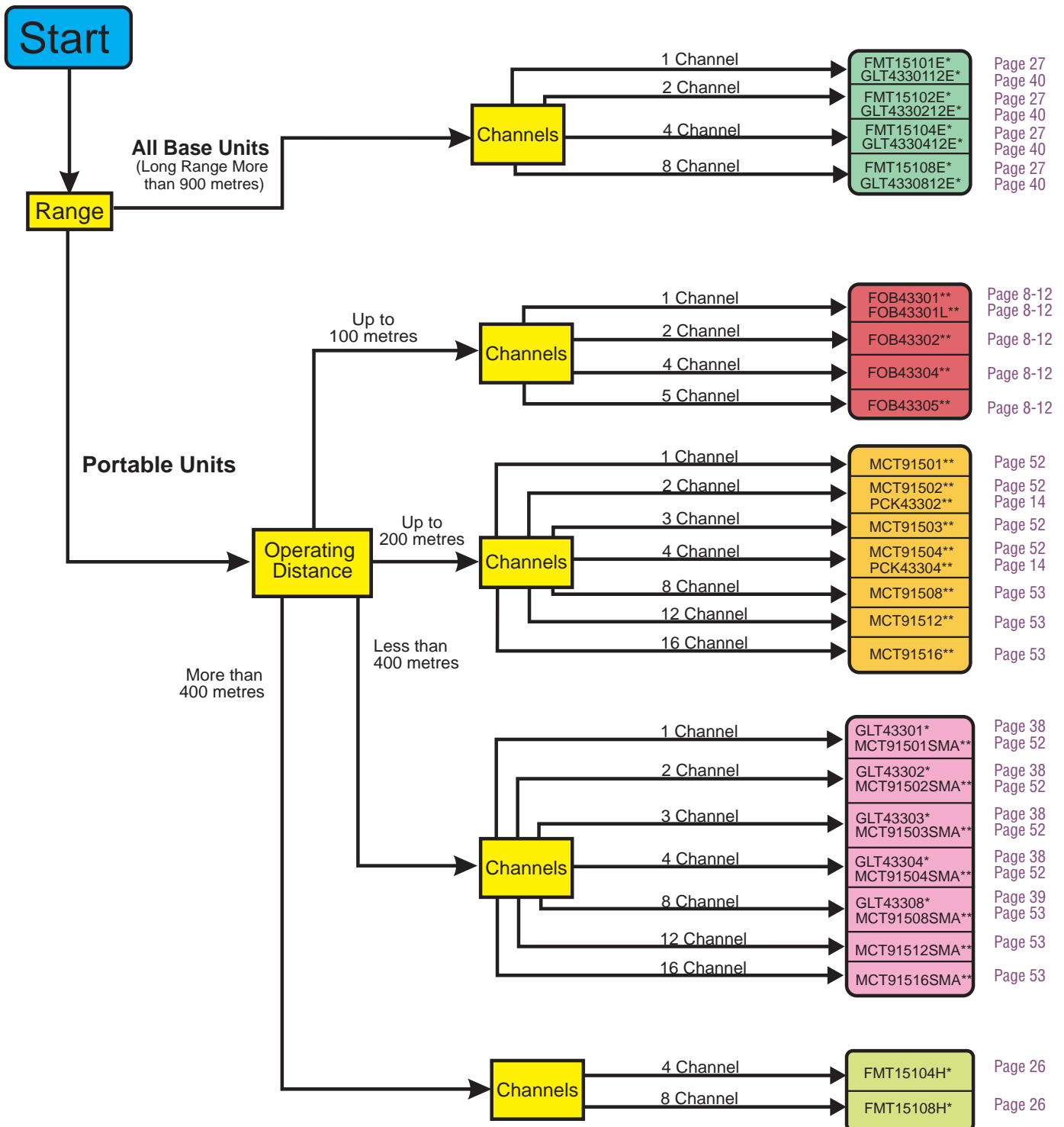

Available in Durable metal case

* Excellent Interference Immunity. Recommended for industrial application **where there** is electrical generated noise. Eg. Electric motors, computers etc.

** Uses frequency hopping, allows simultaneous operation of more than one transmitter to operate in the same area.

Elsema Receiver Selection Guide

433MHz PCR Series

Product	PCR43301RE	PCR43301240R PCR43301240RE	PCR433WG	PCR43302P	
Number of Channels	1	1		2	
Supply Voltage	11-28 VAC/DC	240VAC	11.0 - 28 VAC/DC	7-36 VDC	
Switching Current*	10 Amps	16 Amps	N/A	2A @40VDC Open Collector Output	
Compatible Transmitters	PentaCODE® PentaFOB®	PentaCODE® PentaFOB®	PentaCODE®	PentaCODE® PentaFOB®	
Compatible Antennas	ANT433MHz Series	ANT433MHz Series	ANT 433MHz series	ANT433MHz Series	
Receiver Enclosure	Pre-wired Enclosed in a case	C1020 Weatherproof IP Rating 66	Pre-wired Enclosed in a case	C0611 Weatherproof IP Rating 66	
Page Reference	Page 16	Page 17	Page 18	Page 19	

151MHz FMT Series

Product	FMR15101	FMR15101240	FMR15102	FMR15102240	
Number of Channels	1	1	2	2	
Supply Voltage	11-28 VAC/DC	240 VAC	11-28 VAC/DC	240 VAC	
Switching Current	10 Amps	16 Amps	10 Amps	16 Amps	
Compatible Transmitters	151MHz FMT-Series	151MHz FMT-Series	151MHz FMT-Series	151MHz FMT-Series	
Compatible Antennas	ANT 151MHz Series	ANT 151MHz Series	ANT 151MHz Series	ANT 151MHz Series	
Receiver Enclosure	C1020 Weatherproof IP Rating 66	C1020 Weatherproof IP Rating 66	C1020 Weatherproof IP Rating 66	C1020 Weatherproof IP Rating 66	
Page Reference	Page 28	Page 29	Page 30	Page 31	

	PCR43302R PCR43302RE	PCR43302240R PCR43302240RE	PCR43304R PCR43304RE	PCR43305R PCR43305RE	PCR433USB	PentaFOB® Programmer
	2	2	4	5		Used for advanced programming of the Penta series Receivers when used with PentaFOB® remotes
	11-28 VAC/DC	240VAC	11-28 VAC/DC	11-28 VAC/DC	USB	
	10 Amps	16 Amps	10 Amps	10 Amps	N/A	
	PentaCODE® PentaFOB®	PentaCODE® PentaFOB®	PentaCODE® PentaFOB®	PentaCODE® PentaFOB®	PentaCODE®	
	ANT433MHz Series	ANT433MHz Series	ANT433MHz Series	ANT433MHz Series	ANT433MHz Series	
	Enclosed in a case	C1020 Weatherproof IP Rating 66	C1020 Weatherproof IP Rating 66	C1020 Weatherproof IP Rating 66	Enclosed in a case	
	Page 20	Page 21	Page 22	Page 23	Page 25	Page 13

	FMR15104	FMR15104240	FMR15108	FMR1510812R
	4	4	8	8
	11-28 VAC/DC	240 VAC	11-28 VAC/DC	11-28 VAC/DC
	10 Amps	16 Amps	125mA @ 40VDC Open Collector Output	10 Amps
	151MHz FMT-Series	151MHz FMT-Series	151MHz FMT-Series	151MHz FMT-Series
	ANT 151MHz Series	ANT 151MHz Series	ANT 151MHz Series	ANT 151MHz Series
	C1020 Weatherproof IP Rating 66	C1020 Weatherproof IP Rating 66	C1020 Weatherproof IP Rating 66	C1217 Weatherproof IP Rating 66
	Page 32	Page 33	Page 34	Page 35

Elsema Receiver Selection Guide

433MHz Gigalink® Series

Product	GLR43301	GLR43301240	GLR43302SS GLR43302SST	GLR43302	GLR43302240	
Number of Channels	1	1	2	2	2	
Supply Voltage	11-28 VAC/DC	240 VAC	7-20 VDC	11-28 VAC/DC	240 VAC	
Switching Current*	10 Amps	16 Amps	100mA @ 40VDC Open Collector Output	10 Amps	16 Amps	
Compatible Transmitters	433MHz GLT-Series	433MHz GLT-Series	433MHz GLT-Series	433MHz GLT-Series	433MHz GLT-Series	
Compatible Antennas	ANT 433MHz Series	ANT 433MHz Series	ANT 433MHz Series	ANT 433MHz Series	ANT 433MHz Series	
Receiver Enclosure	C1020 Weatherproof IP Rating 66	C1020 Weatherproof IP Rating 66		C1020 Weatherproof IP Rating 66	C1020 Weatherproof IP Rating 66	
Page Reference	Page 41	Page 42	Page 43	Page 44	Page 45	

915MHz MCR Series

Product	MCR91501R	MCR91502P MCR91502PT	MCR91502R	MCR91503R	MCR91504R	MCR91508POS	
Number of Channels	1	2	2	3	4	8	
Supply Voltage	10-28 VAC/DC	7-36 VDC	10-28 VAC/DC	10-28 VAC/DC	10-28 VAC/DC	10-28 VAC/DC	
Switching Current*	10 Amps	2 Amps @ 40VDC Open Collector Output	10 Amps	10 Amps	10 Amps	120mA @50VDC Positive Switching Outputs	
Compatible Transmitters	915MHz / MCT-Series	915MHz / MCT-Series	915MHz / MCT-Series	915MHz / MCT-Series	915MHz / MCT-Series	915MHz / MCT-Series	
Compatible Antennas	ANT 915MHz Series	ANT 915MHz Series	ANT 915MHz Series	ANT 915MHz Series	ANT 915MHz Series	ANT 915MHz Series	
Receiver Enclosure	C1020 Weatherproof IP Rating 66	C0611 Weatherproof IP Rating 66	C1020 Weatherproof IP Rating 66	C1020 Weatherproof IP Rating 66	C1020 Weatherproof IP Rating 66	C1020 Weatherproof IP Rating 66	
Page Reference	Page 54	Page 55	Page 56	Page 57	Page 58	Page 59	

	GLR43303	GLR43304	GLR43304240	GLR43308POS	GLR43308	GLR43308R
	3	4	4	8	8	8
	11-28 VAC/DC	11-28 VAC/DC	240 VAC	11-28 VAC/DC	11-28 VAC/DC	11-28 VAC/DC
	10 Amps	10 Amps	16 Amps	120mA @50VDC Positive Switching Outputs	125mA @ 40VDC Open Collector Output	10 Amps
	433MHz GLT-Series	433MHz GLT-Series	433MHz GLT-Series	433MHz GLT-Series	433MHz GLT-Series	433MHz GLT-Series
	ANT 433MHz Series	ANT 433MHz Series	ANT 433MHz Series	ANT 433MHz Series	ANT 433MHz Series	ANT 433MHz Series
	C1020 Weatherproof IP Rating 66	C1020 Weatherproof IP Rating 66	C1020 Weatherproof IP Rating 66	C1020 Weatherproof IP Rating 66	C1020 Weatherproof IP Rating 66	C1217 Weatherproof IP Rating 66
	Page 46	Page 47	Page 48	Page 49	Page 50	Page 51

	MCR91508SS	MCR91508R	MCR91512SS	MCR91512R	MCR91516SS	MCR91516R
	8	8	12	12	16	16
	10-28 VAC/DC	10-28 VAC/DC	10-28 VAC/DC	10-28 VAC/DC	10-28 VAC/DC	10-28 VAC/DC
	125mA @ 40VDC Open Collector Output	10 Amps	125mA @ 40VDC Open Collector Output	10 Amps	125mA @ 40VDC Open Collector Output	10 Amps
	915MHz / MCT-Series	915MHz / MCT-Series	915MHz / MCT-Series	915MHz / MCT-Series	915MHz / MCT-Series	915MHz / MCT-Series
	ANT 915MHz Series	ANT 915MHz Series	ANT 915MHz Series	ANT 915MHz Series	ANT 915MHz Series	ANT 915MHz Series
	C1020 Weatherproof IP Rating 66	C1217 Weatherproof IP Rating 66	C1020 Weatherproof IP Rating 66	C1217 Weatherproof IP Rating 66	C1020 Weatherproof IP Rating 66	C1217 Weatherproof IP Rating 66
	Page 60	Page 61	Page 62	Page 63	Page 64	Page 65

PentaFOB® Series

PentaFOB® remotes in IP67 waterproof keyring case



FEATURES

- › Waterproof Keyring transmitters (IP67)
- › Option of 1, 2, 4 or 5 channels
- › Simultaneously transmits the encrypted code on 5 different frequencies, making it impossible for the remote to be interfered with or jammed
- › Uses frequency hopping spread spectrum (FHSS)
- › One of the most secure remote controls on the market
- › Designed in Australia
- › Complies to AS/NZS 4268, CE and FCC
- › Works with all PCR Penta series of receiver



Part Number	Description
FOB43301WP	1-Button, Keyring Remote
FOB43301LWP	1-Large Button, Keyring Remote
FOB43302WP	2-Button, Keyring Remote
FOB43304WP	4-Button, Keyring Remote
FOB43305WP	5-Button, Keyring Remote



TECHNICAL DATA

Over 17 billion encrypted codes
18mA (typical) at 3 Volts DC supply during transmission
Operating range of up to 100 metres depending on building structure and receiver antenna
Operating frequency: 433.100 to 434.700 MHz
Custom front design available
Works with all PCR Penta series of receivers

PentaFOB® Series

PentaFOB® Transmitter with Raised Buttons



FOB43302H



FEATURES

- › PentaFOB® remote with 2 raised buttons
- › Transmits on 5 different frequencies
- › Uses frequency hopping spread spectrum (FHSS)
- › One of the most secure remote controls on the market
- › Designed in Australia
- › Competitive pricing
- › Works with all PCR Penta series of receivers



Batteries Included



DESCRIPTION

The FOB43302H is a hand-held remote control in an industrial case. It has large raised buttons which can easily be pressed even while wearing industrial gloves.

The remote comes with a robust rubber boot which protects it in an event of being dropped or accidentally knocked against hard surfaces.

FOB43302H is powered by 2 x AA batteries for longer life cycle.

TECHNICAL DATA

Powered by 2 x AA batteries (included)

Over 17 billion encrypted codes

18mA (typical) at 3 Volts DC supply during transmission

Operating range of up to 100 metres depending on building structure and receiver antenna

Operating frequency: 433.100 to 434.700 MHz

Dimensions: 125 x 75 x 35 mm

Works with all PCR Penta series of receivers

PentaFOB® Series

433MHz Keyring Remotes

PentaFOB® SERIES

The next generation of remote controls, superior to normal garage door rolling code remotes



FEATURES

- › Keyring transmitter with 1, 2, 4 or 5 channels.
- › Simultaneously transmits the encrypted code on 5 different frequencies, making it impossible for the remote to be interfered with or jammed
- › Uses frequency-hopping spread spectrum (FHSS)
- › One of the most secure remote controls on the market
- › Designed in Australia
- › Competitive pricing

COLOUR OPTIONS

Personalise FOB remotes to match your personal choice or your company colour. Four different colours to choose from.

Default colour is orange.

Part Number	Description
FOB43301	1-Button, Keyring Remote
FOB43301L	1-Large Button, Keyring Remote
FOB43302	2-Button, Keyring Remote
FOB43304	4-Button, Keyring Remote
FOB43305	5-Button, Keyring Remote

The FOB remotes are available in different colours. Add the colour code to the end of the part number to order a different colour. No colour code in the part number is the standard orange.

- RED = Red
- BLU = Blue
- BLK = Black
- xxx = Orange



Case Black
Upper Orange



Case Black
Upper Blue



Case Black
Upper Red

Choose from a range of colour options. Mix and match!
If you require a custom Pantone® colour please contact us for more information

PentaFOB® Series

4-Button, Wireless Wall Remote with PentaFOB® Technology



FOR Switch or
FOB Switch Kit
(PCR43301RE receiver included)



FEATURES

- › Ultra slim and stylish design for wall mount
- › Compatible with standard single-gang electrical box or just screw directly on to the wall
- › Easily replace battery without removing from the wall
- › Uses frequency hopping spread spectrum (FHSS)
- › Designed in Australia
- › Competitive pricing
- › Works with all PCR Penta series of receivers



FOB Switch

DESCRIPTION

The wireless wall remote can be mounted on the standard single-gang electrical wall box or directly on to the wall. It can wirelessly control lights, automatic gates and garage doors. It transmits a wireless signal to the Penta receiver which switches relays to turn the device On and Off. No need to run wires from the wall remote to the lights. Just mount the wall remote on the wall and connect Penta receiver to the light. Modern design and ultra-thin profile.

This wireless wall remote uses PentaFOB® technology

TECHNICAL DATA

Supply Operating range of up to 100 metres depending on building structure and receiver antenna Voltage

Over 17 billion encrypted codes

18mA (typical) at 3 Volts DC supply during transmission

Battery life of 2 years with average use

Operating frequency: 433.100 to 434.700 MHz

Works with all PCR Penta series of receivers

PentaFOB® Series

433MHz PentaFOB® Transmitter with External Input

PentaFOB® SERIES



FOB43301W

FEATURES

- › 2 x AAA battery operated
- › 100m line of sight operation possible
- › Simultaneously transmits the encrypted code on 5 different frequencies, making it impossible for the remote to be interfered with or jammed
- › Uses frequency-hopping spread spectrum (FHSS)
- › Designed in Australia
- › Competitive pricing

Ideal for wireless push button, PLC controls or anywhere else you need a wireless signal to transmit a contact closure.



Batteries included



DESCRIPTION

The FOB43301W is a 1-channel PentaFOB® transmitter designed to be used with external normally open or normally closed contact closure. You can wire in push buttons or easily integrate it into your existing equipment. The transmitter is housed in a compact enclosure with terminal block for easy wiring. A line of sight operating range of 100 metres is possible. The transmitter is powered by 2 x AAA batteries and has a low battery indicator. LED will start flashing when the battery is low.

TECHNICAL DATA

Supply Voltage	2 x AAA Battery
Operating Frequency	433.100 to 434.700MHz
Operating Range	100 metres line of sight
Number of Inputs	1 dry contact
Connections	Screw type terminal block.
Dimensions	65mm x 60mm x 35mm
Useable Receivers	All Elsema 433MHz Penta series

PentaFOB® Programmer

Add, Edit and Delete PentaFOB® transmitters



PentaFOB® Programmer

FEATURES

- › Add, Delete and Edit individual PentaFOB® transmitters from the receiver
- › Backup and Restore receiver's memory to mini FOB chips
- › Easy-to-read with a large LCD display with back light
- › 1-touch Master control for quick and easy setup
- › 1 backup or restore chip is included
- › USB programming cable included
- › Password protect the receiver
- › Ergonomically designed case
- › No battery is required

PentaFOB® SERIES

DESCRIPTION

The PentaFOB® programmer can add, edit and delete individual PentaFOB® transmitters from the receiver's memory. Simply plug-in the USB cable on the back of the programmer and the other end of the cable to the receiver. The programmer will automatically detect the receiver model number and then display the corresponding information. With the easy-to-read 4-line large LCD the setup can be done quickly with clear instructions displayed on the screen.

The programmer has a password feature which allows you to lock the receivers to prevent any unauthorised access to the receiver's memory.

There is a backup or restore memory chip (FOBchip) included with each programmer. This chip is used to backup or restore the contents of a receiver. When there are 100's of transmitters programmed to a receiver the installer normally backs up the receiver memory in case the receiver is damaged or lost.

Additional backup or restore chips are sold separately.

TECHNICAL DATA

Dimensions	102mm x 140mm x 50mm
Display	4-Line LCD display

ACCESSORY

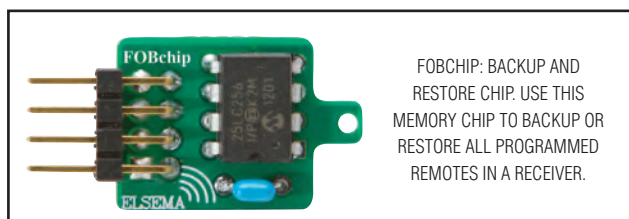

PentaCODE® Series

433MHz Keyring Remotes

PentaCODE® SERIES

The next generation of remote controls, superior to normal garage door rolling code remotes



FEATURES

- › Keyring transmitter with 2 or 4 channels
- › Dual Coding System, 12-way dipswitch coding or one of over 17 billion encrypted codes
- › Simultaneously transmits the code on 5 different frequencies, making it impossible for the remote to be interfered with or jammed
- › Uses frequency-hopping spread spectrum (FHSS)
- › One of the most secure remote controls on the market
- › Designed in Australia and competitive pricing
- › AS/NZS 4268, CE and FCC Certified

Part Number	Description
PCK43302	2-channel, keyring transmitter
PCK43304	4-channel, keyring transmitter
SV100	Sun visor holder or belt clip for keyring transmitter
WB100	Wall mount bracket for the keyring transmitter



PentaCODE® Series

433MHz PentaCODE® Transmitter with External Inputs



PCK43304W

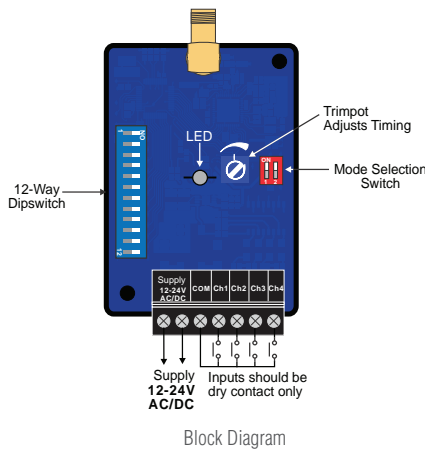

Block Diagram

FEATURES

- › 12 to 24 Volts AC/DC supply
- › 500m line of sight operation possible
- › 12-way dipswitch or encrypted coding
- › Compatible with all Penta series receivers
- › Low standby current. Ideal for battery operation
- › Frequency hopping between 433.100 to 434.700 MHz

Ideal for wireless push button, PLC controls or anywhere else you need a wireless signal to transmit a contact closure.



DESCRIPTION

The PCK43304W is a 4-channel PentaCODE® transmitter designed to be used with external normally open contact closures. You can wire in push buttons or easily integrate it into your existing equipment. The transmitter is housed in a compact 70 x 50 mm enclosure with terminal block for easy wiring. A line of sight operating range of 500 metres is possible.

TECHNICAL DATA

Supply Voltage	12 - 24 Volts AC or DC
Standby Current	6uA standby at 12 Volts DC. (Suitable for battery operation)
Current Consumption	27mA when transmitting
Operating Frequency	433.100 to 434.700MHz
Operating Range	500 metres with ANT433S antenna
Number of Inputs	4 dry contacts, optically isolated
Connections	Screw type terminal block. See block diagram
Dimensions	90mm x 50mm x 25mm
Useable Receivers	All Elsema 433MHz Penta series

PCR43301RE

Receiver with 1 relay output

PENTA SERIES



PCR43301RE

FEATURES

- › One channel receiver pre-wired with relay output
- › 12-way dipswitch coding or one of over 17 billion encrypted codes
- › Supply voltage can be AC or DC
- › Compatible with PentaFOB® and PentaCODE® remotes
- › Unlimited remotes can be programmed to the receiver
- › Highly sensitive receiver input stage
- › Crystal controlled for high reliability
- › Relay modes include Momentary, Latching, delayed off and security latching
- › Easy installation

DESCRIPTION

This receiver is compatible with PentaFOB® and PentaCODE® remotes. The receiver is so small that it can be easily installed into your existing automatic gate opener or garage door controls. Other applications include light control, security shutters or anywhere else you need a wireless signal to transmit a contact closure.

The PentaCODE® dual coding system gives the installer the option to use the classic 12-way dipswitch coding or one of over 17 billion encrypted codes.

With the 12-way dipswitch, just match the keyring remotes and the receiver's dipswitch and it's coded. With the encrypted code you switch all the 12-way dipswitches OFF and the remote and receiver automatically goes into the encrypted coding. Please see coding instructions for encrypted coding procedure.

TECHNICAL DATA

Supply Voltage	11 - 28 VAC/DC. Can use Elsema DC or AC power supply, 12PP1000 or 24PP
Current Consumption	21mA standby
Operating Frequency	433.100 to 434.700 MHz
Sensitivity	Better than 0.316µV (-117dBm) for relay output to switch on
Relay Output	One changeover relay output, rated at 10 Amps / 240VAC
Antenna	Elsema ANT 433MHz series
Dimensions	70 x 55 x 25mm
Useable Transmitters	All Elsema type PCK433 & FOB433 series

PCR43301240R & PCR43301240RE

Receiver with relay output and 110-240AC supply connection



PCR43301240R



PCR43301240RE

FEATURES

- › 110-240 Volts AC Supply
- › One relay output
- › 12-way dipswitch coding or one of over 17 billion encrypted codes
- › Compatible with PentaFOB® and PentaCODE® remotes
- › Unlimited remotes can be programmed to the receiver
- › Highly sensitive receiver input stage
- › Crystal controlled for high reliability
- › Relay modes include Momentary, Latching, delayed off and security latching

DESCRIPTION

With 110-240VAC as the supply, this receiver is connected directly to the mains. It is compatible with PentaFOB® and PentaCODE® remotes. The relay is capable of switching loads of up to 16 Amps. Applications include light control, security shutters or anywhere else you need a wireless signal to transmit a contact closure.

The PentaCODE® dual coding system gives the installer the option to use the classic 12-way dipswitch coding or one of over 17 billion encrypted codes.

With the 12-way dipswitch, just match the keyring remotes and the receiver's dipswitch and it's coded. With the encrypted code you switch all the 12-way dipswitches OFF and the remote and receiver automatically goes into the encrypted coding. Please see coding instructions for encrypted coding procedure.

TECHNICAL DATA

Supply Voltage	110 - 240 Volts AC Mains	
Operating Frequency	433.100 to 434.700MHz	
Sensitivity	Better than 0.316µV (-117dBm) for relay output to switch on	
Relay Output	One changeover relay, rated at 16 Amps/240VAC	
Antenna	Elsema ANT 433MHz series	
Dimensions	120 x 70 x 30mm (PCB assembly)	125 x 80 x 75 mm (enclosed)
Useable Transmitters	All Elsema type PCK433 & FOB433 series	

PCR433WG

433MHz Penta Receiver with Wiegand Output



PCR433WG

FEATURES

- › Easy to add remote controls to any Wiegand input access control panel
- › Remotes are added like cards or RFID tags with no software changes
- › Wireless keyless entry offers convenience, security and safety
- › Applications include: accessing gates, doors and boom gates
- › Wide operating supply voltage and low current consumption
- › Unlimited remotes can be programmed to the receiver
- › Easy way to facilitate for handicapped access
- › Compatible with PentaCODE® remotes
- › Easy to use dipswitch coding
- › Designed in Australia

DESCRIPTION

This receiver allows you to add wireless remote controls to your existing access control systems by connecting the PCR433WG receiver to the access system. The remote controls have a range of up to 200 metres (650 feet) and are available with 1, 2 or 4 buttons. The extra buttons can be used as a panic button allowing a single remote to allow access control and panic alert system.

The receivers Wiegand output interfaces to virtually any commercial access control panel. Remote controls are added as easily as Wiegand cards or RFID tags without any software changes. The ID and facility codes can be matched to the system requirements.

The receiver has a bi-colour LED to act as a status display. Red LED indicates that AC or DC power is "On" and Green LED indicates remote control signal has been received.

TECHNICAL DATA

Supply Voltage	11 - 28 VAC/DC. Can use Elsema DC or AC power supply, 12PP1000 or 24PP
Current Consumption	28mA standby
Operating Frequency	433.100 to 434.700 MHz
Sensitivity	Better than 0.316µV (-117dBm)
Antenna	Elsema ANT 433MHz series
Dimensions	70 x 55 x 25mm
Useable Transmitters	All Elsema type PCK433 series

PCR43302P

Plug-in Type Receiver with two outputs

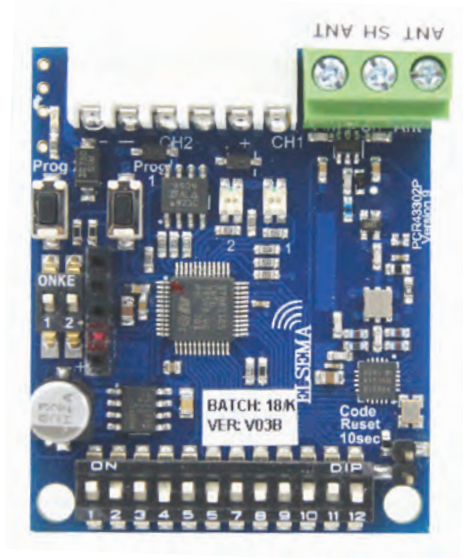

PCR43302P

FEATURES

- › 2 channel version available
- › Plug-in type
- › Uses frequency-hopping spread spectrum (FHSS)
- › One of the most secure remote control systems on the market
- › Designed in Australia
- › Competitive pricing

PENTA SERIES

DESCRIPTION

This receiver is compatible with PentaFOB® and PentaCODE® remotes. One of our smallest receivers measuring 55 x 44 x 13mm. Small but still very powerful using the latest Mosfet technology to give you two outputs with high switching current of 2 Amps at 40VDC each.

The PentaCODE® dual coding system gives the installer the option to use the classic 12-way dipswitch coding or one of over 17 billion encrypted codes.

With the 12-way dipswitch, just match the keyring remotes and the receiver's dipswitch and it's coded. With the encrypted code you switch all the 12-way dipswitches OFF and the remote and receiver automatically goes into the encrypted coding.

The receiver is available as a plug-in type with the standard 6-pin connector. This connector allows you to integrate the receiver into your design. Use 6WHP or 6WLP connector.

TECHNICAL DATA

Supply Voltage	7 - 36 Volts DC
Current Consumption	20mA standby at 24VDC
Operating Frequency	433.100 to 434.700 MHz
Sensitivity	Better than 0.316µV (-117dBm) for output to switch on
Dimensions	55 x 44 x 13mm
Antenna	Elsema ANT 433MHz series
Useable Transmitters	All Elsema type PCK433 & FOB433 series

PCR43302R & PCR43302RE

Receiver with 2 relay outputs

PENTA SERIES



PCR43302RE



PCR43302R

FEATURES

- › Two channel receiver with relay output
- › 12-way dipswitch coding or one of over 17 billion encrypted codes.
- › Supply voltage can be AC or DC
- › Compatible with PentaFOB® and PentaCODE® remotes
- › Unlimited remotes can be programmed to the receiver
- › Highly sensitive receiver input stage
- › Crystal controlled for high reliability
- › Relay modes include Momentary, Latching, delayed off, security latching, on-off and Roller Shutter
- › Easy mounting to cases or walls

DESCRIPTION

This receiver is compatible with PentaFOB® and PentaCODE® remotes. The receiver is small and can be easily installed into your existing automatic gate opener or garage door controls. Other applications include light control, security shutters or anywhere else you need a wireless signal to transmit a contact closure.

The PentaCODE® dual coding system gives the installer the option to use the classic 12-way dipswitch coding or one of over 17 billion encrypted codes.

With the 12-way dipswitch, just match the keyring remotes and the receiver's dipswitch and it's coded. With the encrypted code you switch all the 12-way dipswitches OFF and the remote and receiver automatically goes into the encrypted coding. Please see coding instructions for encrypted coding procedure.

TECHNICAL DATA

Supply Voltage	11 to 28 Volts AC or DC	
Current Consumption	21mA standby at 24VDC	
Operating Frequency	433.100 to 434.700 MHz	
Sensitivity	Better than 0.316µV (-117dBm) for relay output to switch on	
Relay Output	Two changeover relay output, rated at 10 Amps /240VDC	
Antenna	Elsema ANT 433MHz series	
Dimensions	87 x 52 x 20mm (PCB assembly)	140 x 85 x 30mm (enclosed)
Useable Transmitters	All Elsema type PCK433 & FOB433 series	

PCR43302240R & PCR43302240RE

Receiver with 2 relay outputs and 110-240AC supply connection



PCR43302240R



PCR43302240RE

FEATURES

- › 110-240 Volts AC Supply
- › Two relay outputs
- › 12-way dipswitch coding or one of over 17 billion encrypted codes.
- › Compatible with PentaFOB® and PentaCODE® remotes
- › Unlimited remotes can be programmed to the receiver
- › Highly sensitive receiver input stage
- › Crystal controlled for high reliability
- › Relay modes include Momentary, Latching, delayed off, security latching, on-off and Roller Shutter Mode

DESCRIPTION

This receiver is compatible with PentaFOB® and PentaCODE® remotes. It is powered directly from the mains supply. It has two relay outputs which can be switched “on” and “off” independently. The relays are capable of switching loads of up to 16 Amps. Applications include light control, security shutters or anywhere else you need a wireless signal to transmit a contact closure.

The PentaCODE® dual coding system gives the installer the option to use the classic 12-way dipswitch coding or one of over 17 billion encrypted codes.

With the 12-way dipswitch, just match the keyring remotes and the receiver’s dipswitch and it’s coded. With the encrypted code you switch all the 12-way dipswitches OFF and the remote and receiver automatically goes into the encrypted coding. Please see coding instructions for encrypted coding procedure.

TECHNICAL DATA

Supply Voltage	110 - 240 Volts AC Mains	
Operating Frequency	433.100 to 434.700 MHz	
Sensitivity	Better than 0.316µV (-117dBm) for relay output to switch on	
Relay Output	Two changeover relay outputs, rated at 16 Amps / 240VAC	
Antenna	Elsema ANT 433MHz series	
Dimensions	120 x 70 x 30mm (PCB assembly)	125 x 80 x 75 mm (enclosed)
Useable Transmitters	All Elsema type PCK433 & FOB433 series	

PCR43304R & PCR43304RE

Receiver with 4 relay outputs

PENTA SERIES



PCR43304RE

FEATURES

- › Four channel receiver with relay outputs
- › 12-way dipswitch coding or one of over 17 billion encrypted codes
- › Supply voltage can be AC or DC
- › Compatible with PentaFOB® and PentaCODE® remotes
- › Unlimited remotes can be programmed to the receiver
- › Highly sensitive receiver input stage
- › Crystal controlled for high reliability
- › Modes include Momentary, latching and security latching
- › E version available with C1020 case
- › Optional QM150 bracket available for easy mounting to cases or walls

DESCRIPTION

This receiver is compatible with PentaFOB® and PentaCODE® remotes. It has four relay outputs which can be switched “on” and “off” independently. The relays are capable of switching loads of up to 10 Amps.

The PentaCODE® dual coding system gives the installer the option to use the classic 12-way dipswitch coding or one of over 17 billion encrypted codes.

With the 12-way dipswitch, just match the keyring remotes and the receiver’s dipswitch and it’s coded. With the encrypted code you switch all the 12-way dipswitches OFF and the remote and receiver automatically goes into the encrypted coding. Please see coding instructions for encrypted coding procedure.

TECHNICAL DATA

Supply Voltage	11 - 28 VAC/DC. Can use Elsema DC or AC power supply, 12PP1000 or 24PP
Current Consumption	15mA standby at 24VDC
Operating Frequency	433.100 to 434.700 MHz
Sensitivity	Better than 0.316µV (-117dBm) for relay output to switch on
Relay Output	Four changeover relay outputs, rated at 10 Amps / 240VAC
Antenna	Elsema ANT 433MHz series
Dimensions	130 x 70 x 20mm
Useable Transmitters	All Elsema type PCK433 & FOB433 series

PCR43305R & PCR43305RE

Receiver with 5 relay outputs



PCR43305RE

FEATURES

- › Five channel receiver with relay outputs
- › 12-way dipswitch coding or one of over 17 billion encrypted codes
- › Supply voltage can be AC or DC
- › Compatible with PentaFOB® and PentaCODE® remotes
- › Unlimited remotes can be programmed to the receiver
- › Highly sensitive receiver input stage
- › Crystal controlled for high reliability
- › Modes include Momentary, latching and security latching
- › E version available with C1020 case
- › Optional QM150 bracket available for easy mounting to cases or walls

PENTA SERIES

DESCRIPTION

This receiver is compatible with PentaFOB® and PentaCODE® remotes. It has five relay outputs which can be switched “on” and “off” independently. The relays are capable of switching loads of up to 10 Amps.

The PentaCODE® dual coding system gives the installer the option to use the classic 12-way dipswitch coding or one of over 17 billion encrypted codes.

With the 12-way dipswitch, just match the keyring remotes and the receiver’s dipswitch and it’s coded. With the encrypted code you switch all the 12-way dipswitches OFF and the remote and receiver automatically goes into the encrypted coding. Please see coding instructions for encrypted coding procedure.

TECHNICAL DATA

Supply Voltage	11 - 28 VAC/DC. Can use Elsema DC or AC power supply, 12PP1000 or 24PP
Current Consumption	15mA standby
Operating Frequency	433.100 to 434.700 MHz
Sensitivity	Better than 0.316µV (-117dBm) for relay output to switch on
Relay Output	Five changeover relay outputs, rated at 10 Amps / 240VAC
Antenna	Elsema ANT 433MHz series
Dimensions	130 x 70 x 20mm
Useable Transmitters	All Elsema type PCK433 & FOB433 series

PCTR433

Repeater for PentaFOB® & PentaCODE® Remotes



PCTR433

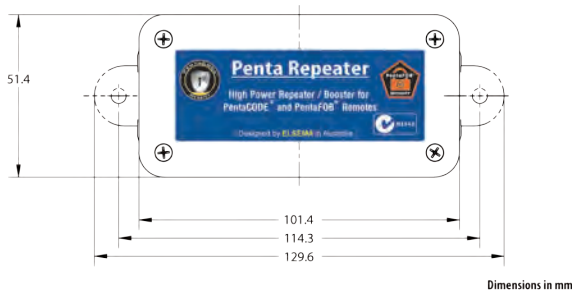

FEATURES

- › Compatible with “PentaFOB®” and “PentaCODE®”remotes
- › Micro USB or external supply
- › Unlimited remotes can be programmed
- › Highly sensitive receiver input stage
- › Crystal controlled for high reliability
- › Easy mounting to walls

DESCRIPTION

The Penta Repeater, intelligently repeats the transmission from the PentaFOB® and PentaCODE® remote's. The repeated signal is transmitted with high RF power which can increase the operating range of the remote to 500 metres. The repeater can be powered either by the micro USB connection or 12-24 Volts AC/DC supply.

If multiple repeaters are used for the same application, each repeater can be given different addresses with the digital display. The repeaters memory can be backed up using the PentaFOB programmer.

TECHNICAL DATA

Supply Voltage	11 - 28 Volts AC/DC or Micro USB
Current Consumption	25mA standby
Operating Frequency	433.100 to 434.700 MHz
Sensitivity	Better than 0.316µV (-117dBm)
Useable Transmitters	All Elsema type PCK433 & FOB433 series
Useable Receivers	All Elsema type Penta Receivers
Operating Range	Up to 500 metres depending on building structure and antenna

PENTA SERIES

PCR433USB

Penta receiver with USB output



PCR433USB

FEATURES

- › Compatible with PentaCODE® remotes
- › USB output. Connects directly to your computer
- › Highly sensitive receiver input stage
- › Crystal controlled for high reliability
- › Easy mounting to walls

DESCRIPTION

The PCR433USB receiver is used to monitor the transmission of PentaCODE® remote control using computer database software.

The software runs on your PC and has a database to which it records the transmitter identity every time the transmitter is used.

Each transmitter can have up to five different identifiers. For example, the name, phone number, fax and address of a person using the transmitter.

The software can be configured to prompt an alarm dialog box and activate a relay, when a transmitter is activated.

TECHNICAL DATA

Supply Voltage	USB
Current Consumption	25mA standby
Operating Frequency	433.100 to 434.700 MHz
Sensitivity	Better than 0.316µV (-117dBm)
Useable Transmitters	All Elsema type PentaCODE®
PC Software	Elsema's FMR-232R

FMT15104H and FMT15108H

151MHz Transmitter for up to 800 metres

FMT151 SERIES



FEATURES

- › Available with 4 or 8 channels
- › Built-in LED indicates button activation
- › Compatible with all FMR151 series receivers
- › Hand-held transmitter includes pre-tuned 151MHz antenna
- › Easy to program and install with code switch technology
- › Available with customised front label, brand it with your own company logo. NL Version
- › Not affected by natural or man-made electrical interference

DESCRIPTION

This hand-held transmitter has an operating range of up to 800 metres. With 100mW transmission power and only using 85mA during transmission makes it ideal for portable applications using a standard 9 volt battery.

Each transmitter button is individually transmitted to the receiver making it possible to do simultaneous channel transmission. This means that up to 8 different functions can be done at the same time. Each button can operate any FMR151... series receivers making it possible to transmit each button to different single channel receivers or to multi-channel receivers.

TECHNICAL DATA

Power Source	9 Volt battery. Duracell or Energizer is recommended due to higher power
Current Consumption	85mA at 9VDC (only when transmitting)
Operating Frequency	151.600MHz (8 user selectable frequencies)
Dimensions	130 x 67 x 27mm
Useable Operating Range	Up to 800 metres, depending on installation
Compatible Receivers	Elsema type FMR151... series (with correct setting on the dipswitch)

ACCESSORY

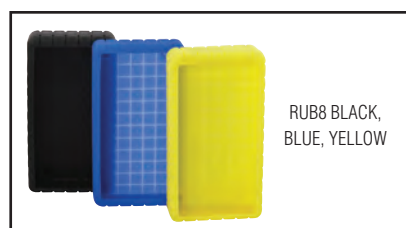

FMT15101E, FMT15102E, FMT15104E & FMT15108E : With Metal Alloy Case FMT15108 : No Case Version

151MHz Base Station High Powered Transmitter for up to 5000 metres



FMT15108E

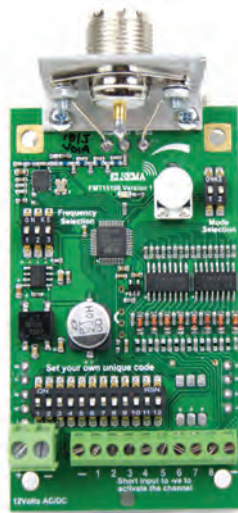

FMT15108

FEATURES

- › Available with 1, 2, 4 and 8 channel inputs
- › Built-in LED indicates transmission
- › User selectable up to 8 different frequencies
- › Compatible with all FMR151 series receivers
- › Easy to program and install with code switch technology
- › Available with durable alloy metal case, E in the part number
- › No Case version allows user to install in their own case
- › Selectable transmission modes, off delay, continuous and one burst
- › Not affected by natural or man-made electrical interference

FMT151 SERIES

DESCRIPTION

This FMT151 series has a transmission power of 100mW and a current consumption of only 85mA. It gives a controlled range of up to 5000 metres. The controlled operation can be any electronic or electrical operated device when used with the FMR151... series of receivers.

The channels are activated via screw type terminals onto which the user can connect reed switches, toggle switches, push buttons or any form of normally open (NO) contact.

TECHNICAL DATA

Power Source	11.0 - 13.6 VDC	
Current Consumption	85mA transmitting, 10µA on standby	
Operating Frequency	151.600MHz (8 user selectable frequencies)	
Dimensions	90 x 56 x 15mm (PCB assembly)	140 x 60 x 34mm (enclosed)
Useable Operating Range	Up to 5000 metres, depending on installation and type of antenna used. Recommended antenna is Elsema ANT151M.	
Compatible Receivers	Elsema type FMR151... series (with correct setting on the dipswitch)	

FMR15101

151MHz Narrow Band FM Receiver with Relay Output

FMR151 RECEIVER

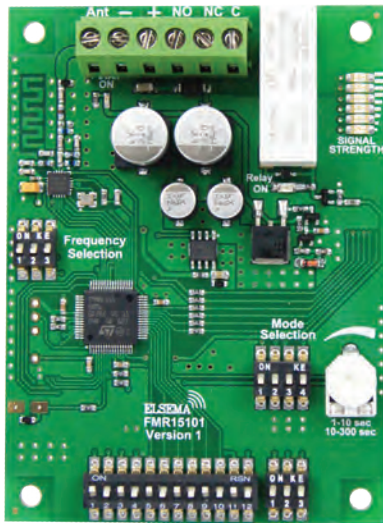

FEATURES

- › Single channel receiver with relay output
- › Supply voltage can be AC or DC
- › Low current consumption
- › Built-in noise or signal strength indicator
- › User can select 8 different frequencies
- › Momentary, Latching, Security Latching, Off delay and Pulsing modes are all user selectable
- › Easy code setup with dipswitch settings
- › Optional QM100 bracket available for easy mounting to cases or walls. C1020 case is also available

DESCRIPTION

This receiver gives you a single relay output with a contact rating of 10 amps at 240VAC. The relay mode can be set to momentary, latching, security latching, adjustable timed off delays or pulsing.

The user can select 8 different narrow band frequencies and program unlimited number of transmitters to the receiver. With a narrow band FM 151MHz signal from the transmitter a line of

sight operating range of 5000 metres is possible. The receiver uses a crystal oscillator circuit that ensures high frequency stability allowing optimal performance in the receiving range.

TECHNICAL DATA

Supply Voltage	11 - 28 Volts AC or DC. Can use Elsema DC or AC power supply, 12PP1000 or 24PP
Current Consumption	35mA standby
Receiving Frequency	150.825, 150.900, 151.025, 151.175, 151.400, 151.600, 151.775 and 152.375MHz
Sensitivity	Better than 0.5µV (for relay to activate)
Output	Changeover relay output, rated at 10 Amps / 240VAC
Antenna	Elsema ANT151S or ANT151M
Dimensions	95 x 70 x 20mm
Compatible Transmitters	All Elsema type FMT151 series

FMR15101240 and FMR15101240E

151MHz Narrow Band FM Receiver with Relay Output

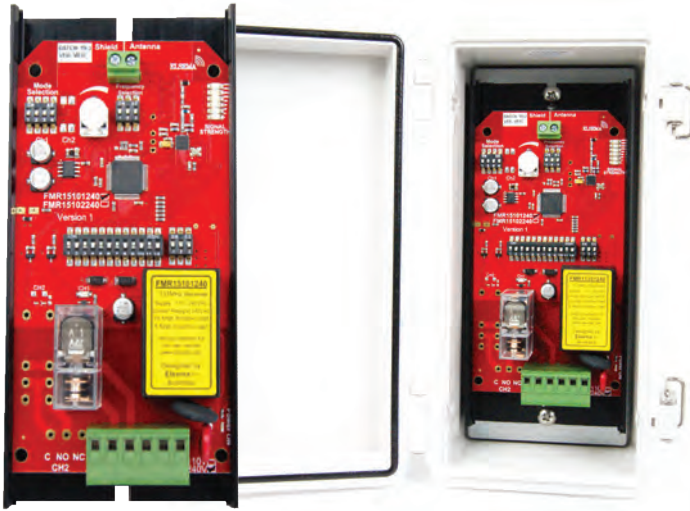

FMR15101240

FMR15101240E

FEATURES

- › Supply voltage 110-240VAC
- › Single channel receiver with relay output
- › Low current consumption
- › Built-in noise or signal strength indicator
- › User can select 8 different frequencies
- › Momentary, Latching, Security Latching and Off delay modes are all user selectable
- › Easy code setup with dipswitch settings
- › Optional QM150 bracket available for easy mounting to cases or walls. C1020 case is also available

FMR151 RECEIVER

DESCRIPTION

This receiver can be connected directly to the mains supply. The relay output is rated at 16 amps at 240VAC. The relay mode can be set to momentary, latching, security latching or adjustable timed off delays.

The user can select 8 different narrow band frequencies and program unlimited number of transmitters to the receiver. With

the narrow band FM 151MHz signal from the transmitter a line of sight operating range of 5000 metres is possible. The receiver uses a crystal oscillator circuit that ensures high frequency stability allowing optimal performance in the receiving range.

TECHNICAL DATA

Supply Voltage	110 - 240 Volts AC mains
Current Consumption	4.2mA standby
Receiving Frequency	150.825, 150.900, 151.025, 151.175, 151.400, 151.600, 151.775 and 152.375MHz
Sensitivity	Better than 0.5µV (for relay to activate)
Output	Changeover relay output, rated at 16 Amps / 240VAC
Antenna	Elsema ANT151S or ANT151M
Dimensions	130 x 70 x 37mm
Compatible Transmitters	All Elsema type FMT151 series

FMR15102

151MHz Narrow Band FM Receiver with Two Relay Outputs

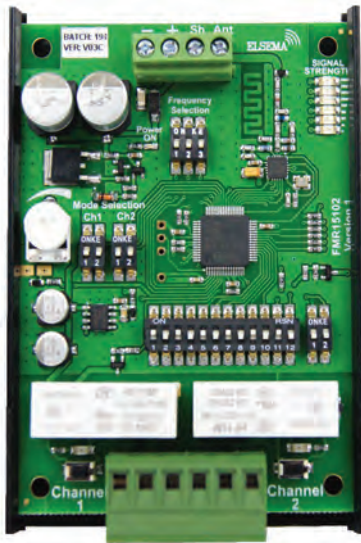

FMR151 RECEIVER

FEATURES

- › Two channel receiver with relay outputs
- › Supply voltage can be AC or DC
- › Low current consumption
- › Built-in noise or signal strength indicator
- › User can select 8 different frequencies
- › Momentary, Latching, Security Latching modes are all user selectable
- › Easy code setup with dipswitch settings
- › Optional QM100 bracket available for easy mounting to cases or walls. C1020 case is also available

DESCRIPTION

This receiver gives you two relay outputs with a contact rating of 10 amps at 240VAC. The relay mode can be set to momentary, latching or security latching.

The user can select 8 different narrow band frequencies and program unlimited number of transmitters to the receiver. With a narrow band FM 151MHz signal from the transmitter a line of

sight operating range of 5000 metres is possible. The receiver uses a crystal oscillator circuit that ensures high frequency stability allowing optimal performance in the receiving range.

TECHNICAL DATA

Supply Voltage	11 - 28 Volts AC or DC. Can use Elsema DC or AC power supply, 12PP1000 or 24PP
Current Consumption	35mA standby
Receiving Frequency	150.825, 150.900, 151.025, 151.175, 151.400, 151.600, 151.775 and 152.375MHz
Sensitivity	Better than 0.5µV (for relay to activate)
Output	Two changeover relay outputs, rated at 10 Amps / 240VAC
Antenna	Elsema ANT151S or ANT151M
Dimensions	95 x 70 x 20mm
Compatible Transmitters	All Elsema type FMT151 series

FMR15102240 and FMR15102240E

151MHz Narrow Band FM Receiver with Two Relay Outputs



FMR15102240

FMR15102240E

FEATURES

- › Supply voltage 110-240VAC
- › Two channel receiver with relay outputs
- › Low current consumption
- › Built-in noise or signal strength indicator
- › User can select 8 different frequencies
- › Momentary, Latching, Security Latching modes are all user selectable
- › Easy code setup with dipswitch settings
- › Optional QM150 bracket available for easy mounting to cases or walls. C1020 case is also available

FMR151 RECEIVER

DESCRIPTION

This receiver can be connected directly to the mains supply. There are two relay outputs that can switch currents up to 16 amps at 240VAC. The relay mode can be set to momentary, latching or security latching.

The user can select 8 different narrow band frequencies and program unlimited number of transmitters to the receiver. With

the narrow band FM 151MHz signal from the transmitter a line of sight operating range of 5000 metres is possible. The receiver uses a crystal oscillator circuit that ensures high frequency stability allowing optimal performance in the receiving range.

TECHNICAL DATA

Supply Voltage	110 - 240 Volts AC mains
Current Consumption	4.2mA standby
Receiving Frequency	150.825, 150.900, 151.025, 151.175, 151.400, 151.600, 151.775 and 152.375MHz
Sensitivity	Better than 0.5µV (for relay to activate)
Output	Two changeover relay outputs, rated at 16 Amps / 240VAC
Antenna	Elsema ANT151S or ANT151M
Dimensions	130 x 70 x 37mm
Compatible Transmitters	All Elsema type FMT151 series

FMR15104

151MHz Narrow Band FM Receiver with Four Relay Outputs

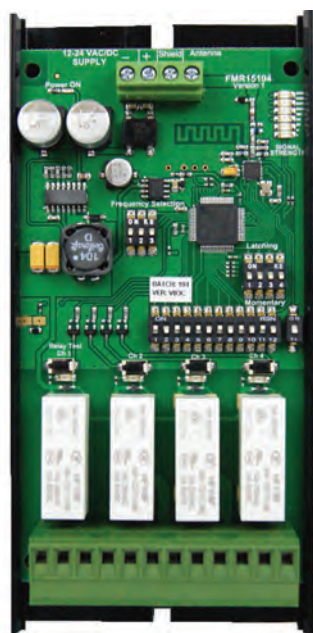

FMR151 RECEIVER

FEATURES

- › Four channel receiver with relay outputs
- › Supply voltage can be AC or DC
- › Low current consumption
- › Built-in noise or signal strength indicator
- › User can select 8 different frequencies
- › Momentary and Latching modes are all user selectable
- › Easy code setup with dipswitch settings
- › Optional QM150 bracket available for easy mounting to cases or walls. C1020 case is also available

DESCRIPTION

This receiver gives you four relay outputs with a contact rating of 10 amps at 240VAC. The relay mode can be set to momentary or latching.

The user can select 8 different narrow band frequencies and program unlimited number of transmitters to the receiver. With a narrow band FM 151MHz signal from the transmitter a line of

sight operating range of 5000 metres is possible. The receiver uses a crystal oscillator circuit that ensures high frequency stability allowing optimal performance in the receiving range.

TECHNICAL DATA

Supply Voltage	11 - 28 Volts AC or DC. Can use Elsema DC or AC power supply, 12PP1000 or 24PP
Current Consumption	35mA standby
Receiving Frequency	150.825, 150.900, 151.025, 151.175, 151.400, 151.600, 151.775 and 152.375MHz
Sensitivity	Better than 0.5µV (for relay to activate)
Output	Four changeover relay outputs, rated at 10 Amps / 240VAC
Antenna	Elsema ANT151S or ANT151M
Dimensions	130 x 70 x 20mm
Compatible Transmitters	All Elsema type FMT151 series

FMR15104240 and FMR15104240E

151MHz Narrow Band FM Receiver with 240VAC Supply connection and 4 Relay Outputs



FMR15104240

FEATURES

- › Supply voltage 240VAC
- › Four channel receiver with relay outputs
- › Low current consumption
- › Built-in noise or signal strength indicator
- › User can select 8 different frequencies
- › Momentary, Latching and Security Latching modes are all user selectable
- › Easy code setup with dipswitch settings
- › Optional QM150 bracket available for easy mounting to cases or walls. C1020 weatherproof case is also available

FMR151 RECEIVER

DESCRIPTION

This receiver can be connected directly to the mains supply, 240VAC. There are four relay outputs that can switch currents up to 16 amps at 240VAC. The relay mode can be set to momentary, latching or security latching.

The user can select 8 different narrow band frequencies and program unlimited number of transmitters to the receiver. With

the narrow band FM 151MHz signal from the transmitter a line of sight operating range of 5000 metres is possible. The receiver uses a crystal oscillator circuit that ensures high frequency stability allowing optimal performance in the receiving range.

TECHNICAL DATA

Supply Voltage	240 Volts AC mains
Current Consumption	5.1mA standby
Receiving Frequency	150.825, 150.900, 151.025, 151.175, 151.400, 151.600, 151.775 and 152.375MHz
Sensitivity	Better than 0.5µV (for relay to activate)
Output	Four changeover relay outputs, rated at 16 amps / 240VAC
Antenna	Elsema ANT151M
Dimensions	160 x 70 x 30mm
Compatible Transmitters	All Elsema type FMT151 series

FMR15108

151MHz Narrow Band FM Receiver with Eight Open Collector Outputs

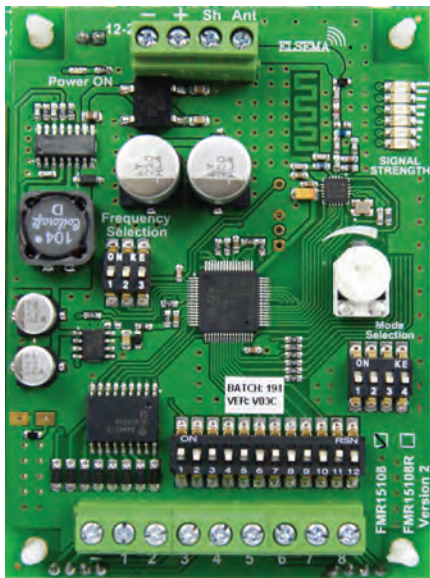

FMR151 RECEIVER

FEATURES

- › Eight channel receiver with open collector outputs
- › Supply voltage can be AC or DC
- › Low current consumption
- › Built-in noise or signal strength indicator
- › User can select 8 different frequencies
- › Momentary, Latching and Security Latching modes are all user selectable
- › Easy code setup with dipswitch settings
- › Optional QM100 bracket available for easy mounting to cases or walls. C1020 case is also available

DESCRIPTION

This receiver gives you eight open collector outputs. The output mode can be set to momentary, latching or security latching.

The user can select 8 different narrow band frequencies and program unlimited number of transmitters to the receiver. With a narrow band FM 151MHz signal from the transmitter a line of sight operating range of 5000 metres is possible. The receiver

uses a crystal oscillator circuit that ensures high frequency stability allowing optimal performance in the receiving range.

TECHNICAL DATA

Supply Voltage	11 - 28 Volts AC or DC. Can use Elsema DC or AC power supply, 12PP1000 or 24PP
Current Consumption	35mA standby
Receiving Frequency	150.825, 150.900, 151.025, 151.175, 151.400, 151.600, 151.775 and 152.375MHz
Sensitivity	Better than 0.5µV (for output to activate)
Output	Eight open collector outputs
Antenna	Elsema ANT151S or ANT151M
Dimensions	90 x 70 x 15mm
Compatible Transmitters	All Elsema type FMT151 series

FMR1510812R

151MHz Narrow Band FM Receiver with Eight Relay Outputs

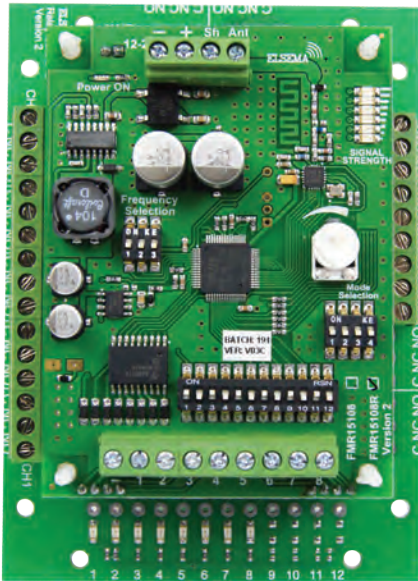

FEATURES

- › Eight channel receiver with relay outputs
- › Supply voltage can be AC or DC
- › Low current consumption
- › Built-in noise or signal strength indicator
- › User can select 8 different frequencies
- › Momentary, Latching and Security Latching modes are all user selectable
- › Easy code setup with dipswitch settings
- › C1520 case is also available

FMR151 RECEIVER

DESCRIPTION

This receiver gives you eight relay outputs with a contact rating of 10 Amps at 240VAC. The relay mode can be set to momentary, latching or security latching.

The user can select 8 different narrow band frequencies and program unlimited number of transmitters to the receiver. With a narrow band FM 151MHz signal from the transmitter a line of

sight operating range of 5000 metres is possible. The receiver uses a crystal oscillator circuit that ensures high frequency stability allowing optimal performance in the receiving range.

TECHNICAL DATA

Supply Voltage	11 - 28 Volts AC or DC. Can use Elsema DC or AC power supply, 12PP1000 or 24PP
Current Consumption	40mA standby
Receiving Frequency	150.825, 150.900, 151.025, 151.175, 151.400, 151.600, 151.775 and 152.375MHz
Sensitivity	Better than 0.5µV (for relay to activate)
Output	Eight changeover relay outputs, rated at 10 Amps / 240VAC
Antenna	Elsema ANT151S or ANT151M
Dimensions	130 x 94 x 42mm
Compatible Transmitters	All Elsema type FMT151 series

RXA15101E

151MHz Narrow Band FM Receiver for Analog signal using 4–20mA

RXA15101E



FEATURES

- › One 4-20mA analog output and one digital output
- › Supply voltage can be AC or DC
- › Low current consumption
- › Built-in noise or signal strength indicator
- › User can select 8 different frequencies
- › Easy code setup with dipswitch settings

DESCRIPTION

The 151MHz receivers use dual conversion, narrow band FM which makes it ideal for industrial applications. Built-into the receiver is a noise and signal strength indicator. The user selectable frequency synthesizer allows for easy installation on a frequency that is not in use, allowing optimal performance in the receiving range.

The receiver has a 4-20mA analog signal output and a relay output. The analog and digital signal transmitted from the TXA15101E transmitter is recreated at the receiver.

TECHNICAL DATA

Supply Voltage	10 - 28 Volts DC. Can use Elsema DC or AC power supply, 12PP1000 or 24PP
Current Consumption	35mA standby
Receiving Frequency	150.825, 150.900, 151.025, 151.175, 151.400, 151.600, 151.775 and 152.375MHz
Sensitivity	Better than 0.5µV (for signal reception)
Output	4-20 mA analog signal and 1 relay output
Antenna	Elsema ANT151S or ANT151M
Dimensions	125 x 80 x 33mm
Compatible Transmitters	Elsema type TXA15101E

TXA15101E

151MHz Analog Transmitter for up to 5000 metres



TXA15101E

FEATURES

- › 1 Analog input which is 4-20mA with 10 bit accuracy
- › 1 Digital input which is a voltage-free contact
- › User selectable up to 8 different frequencies
- › Compatible with RXA15101E receiver
- › Easy to program and install with code switch technology.
- › Available with durable alloy metal case
- › Not affected by natural or man-made electrical interference
- › User selectable sampling rate for analog input

DESCRIPTION

The TXA15101E is an analog and digital 151MHz transmitter. The analog signal, normally 4-20mA is transmitted and then recreated at the receivers (RXA15101E) analog output. Also, the digital input can be simultaneously transmitted with the analog signal. This eliminates the high cost of wiring and has the flexibility of wireless data collection.

Using 151MHz has superior penetration in congested industrial environments with steel construction. Higher frequencies such as 433MHz or 915MHz tend to reflect off metal and make wireless data collection difficult.

TECHNICAL DATA

Power Source	11.0 - 13.6 VDC
Current Consumption	85mA transmitting. 12mA on standby
Operating Frequency	151.600MHz (8 user selectable frequencies)
Dimensions	140 x 60 x 34mm
Useable Operating Range	Up to 5000 metres, depending on installation and type of antenna used. Recommended antenna is Elsema ANT151M.
Compatible Receivers	Elsema type RXA15101E (with correct setting on the dipswitch)

GLT43300, GLT43301, GLT43302, GLT43303, GLT43304

433MHz Hand-held Gigalink® Transmitter

GLT433 SERIES



GLT43300
For Customised Keypads



GLT43301



GLT43302



GLT43303

FEATURES

- › Hand-held transmitter
- › Available with 1, 2, 3 and 4 channels
- › Over 4 billion code combinations
- › Built-in LED indicates button activation
- › Compatible with all GLR433 series receivers
- › Available with customised front label, brand it with your own company logo. NL Version
- › Available with no case to allow OEM manufacturers to use their own case. NC Version



GLT43304



GLT43300NL
For Customised Keypads and Labels

TECHNICAL DATA

Power Source	9 Volt battery
Current Consumption	35mA (typical) at 8VDC only during transmission
Operating Frequency	433.920MHz (other frequencies available on request)
Dimensions	81 x 56 x 24mm
Useable Operating Range	Up to 350 metres (varies upon receiver antenna & location)
Compatible Receivers	All Elsema type GLR433 series

ACCESSORY



GLT43308, GLT43308NL and GLT43308NC

433MHz Hand-held 8 Channel Gigalink® Transmitters



GLT43308



GLT43308NL
For Customised Keypads

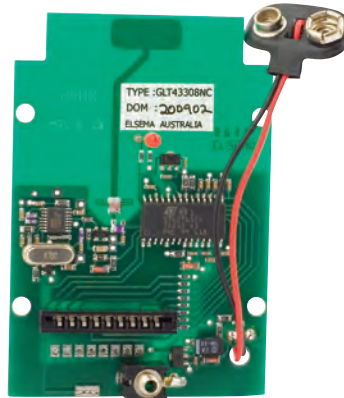

GLT43308NC

FEATURES

- › Hand-held transmitter
- › Available with 8 channels
- › Built-in LED indicates button activation
- › Compatible with all GLR433 series receivers
- › Over 4 billion code combinations
- › Available with customised front label, brand it with your own company logo. NL Version
- › Available with no case to allow OEM manufacturers to use their own case. NC Version

GLT433 SERIES

DESCRIPTION

The hand-held Gigalink® transmitters are the most advanced remote control technology available in the world today. Gigalink® is an invention that has revolutionised the entire remote control technology including Elsema's earlier version of

FMT- ... and FMR- ... series. The GLT433 series state-of-the-art invention brings a new dimension in the world of remote control technology in domestic, commercial and industrial applications.

TECHNICAL DATA

Power Source	9 Volt battery	
Current Consumption	35mA (typical). Only during transmission	
Operating Frequency	433.920MHz (other frequencies available on request)	
Dimensions	130 x 67 x 27mm (with case)	70 x 50 x 14mm (No Case, NC)
Useable Operating Range	Up to 500 metres (varies upon receiver antenna & location)	
Compatible Receivers	All Elsema type GLR433 series	

ACCESSORY

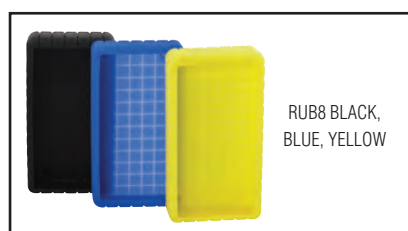

GLT4330112E, GLT4330212E, GLT4330412E, GLT4330812E and GLT4330812NC

433MHz Base Station High Powered Gigalink® Transmitter for up to 1500 metres

GLT433 SERIES



GLT4330112E



GLT4330212E

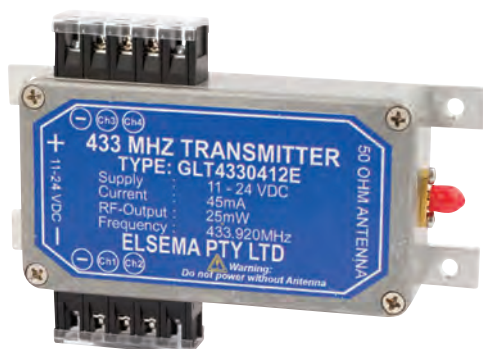

GLT4330412E



GLT4330812E



GLT4330812NC

FEATURES

- › Available for 1, 2, 4 and 8 channel applications
- › Over 4 billion code combinations
- › Built-in LED indicates transmission
- › Compatible with all GLR433 series receivers
- › 25mWatt 433MHz transmissions for ranges up to 1000 metres
- › Available with durable alloy metal case, E in the part number or no case, NC
- › Selectable transmission modes, off delay, continuous and one burst

TECHNICAL DATA

Power Source	11 - 24 VDC	
Current Consumption	20uA on standby and 45mA at 12VDC supply while transmitting	
Operating Frequency	433.920MHz (other frequencies available on request)	
Dimensions	90 x 56 x 15mm (No Case, NC)	140 x 60 x 34mm (with metal case)
Useable Operating Range	Up to 1000 metres, depending on installation and type of antenna used. Recommended Antenna is Elsema ANT433M.	
Compatible Receivers	All Elsema type GLR433 series	

GLR43301 and GLR43301E

433MHz Gigalink® Receiver with Relay Output

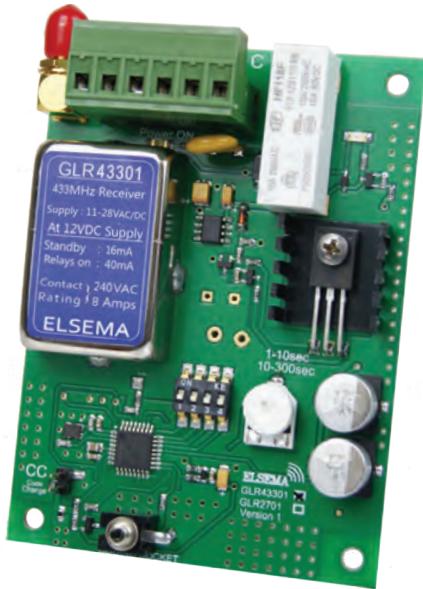

GLR43301

FEATURES

- › Single channel receiver with relay output
- › Over 4 billion code combinations
- › Supply voltage can be AC or DC
- › Highly sensitive receiver input stage
- › Crystal controlled for high reliability
- › Can store unlimited number of transmitters
- › Relay modes include Momentary, Latching, 1-300 second delayed off, pulsing, security latching, on-off and custom
- › E version available with black ABS case
- › Built-in test switch to activate relay
- › Optional QM100 bracket available for easy mounting to cases or walls

DESCRIPTION

This Gigalink® receiver gives you a relay output that can switch currents up to 10 Amps. There is an on-board relay test switch (4th Dipswitch) and a LED to indicate when the relay is “on”. The receiver has a power “on” LED to indicate that the correct supply voltage is connected.

The receiver’s micro-controller can store unlimited number of transmitters with a high security level using the encrypted 32-bit digital code. Included with the receiver is the Gigalink® programming cable.

TECHNICAL DATA

Supply Voltage	11 - 28 VAC/DC. Can use Elsema DC or AC power supply, 12PP1000 or 24PP
Current Consumption	16mA standby
Receiving Frequency	433.920MHz (other frequencies available on request)
Sensitivity	Better than 1µV (for relay output to switch on)
Relay Output	Changeover relay output, rated at 10 Amps / 240VAC
Antenna	Elsema ANT 433MHz series
Dimensions	96 x 70 x 20mm
Compatible Transmitters	Elsema type GLT433 series

GLR43301240 and GLR43301240E

433MHz Gigalink® Receiver with 240VAC Supply connection and 1 Relay Output



GLR43301240



GLR43301240E

FEATURES

- › Single channel receiver with relay output
- › Over 4 billion code combinations
- › Supply voltage is 240 Volts AC
- › Highly sensitive receiver input stage
- › Crystal controlled for high reliability
- › Can store unlimited number of transmitters
- › Modes include Momentary, Latching, 1-300 second delayed off, pulsing, security latching, on-off and custom
- › E version available with IP66 rated case
- › Built-in test switch to activate relay
- › Optional QM150 bracket available for easy mounting to cases or walls

DESCRIPTION

This Gigalink® receiver can be connected directly to the mains supply, 240VAC. There is an on-board switch to test the relay and a LED to indicate when the relay is “on”. The receiver has a power “on” LED to indicate that the correct supply voltage is connected.

The receiver's micro-controller can store unlimited number of transmitters with a high security level using the encrypted 32-bit digital code. Included with the receiver is the Gigalink® programming cable.

TECHNICAL DATA

Supply Voltage	240 VAC Mains
Current Consumption	2.2mA standby
Receiving Frequency	433.920MHz (other frequencies available on request)
Sensitivity	Better than 1µV (for the relay output to switch on)
Output	Changeover relay output, rated at 16 Amps / 240VAC
Antenna	Elsema ANT 433MHz series
Dimensions	130 x 70 x 37mm
Compatible Transmitters	Elsema type GLT433 series

GLR43302SS and GLR43302SST

433MHz Gigalink® Receiver with Two Open Collector Outputs

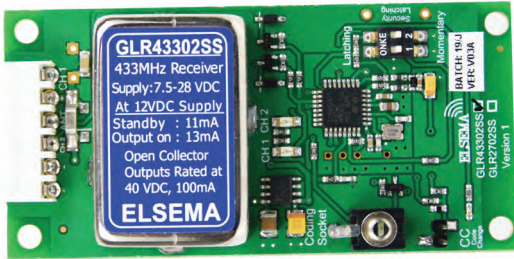

GLR43302SS



GLR43302SST

FEATURES

- › Two open collector outputs
- › Over 4 billion code combinations
- › Highly sensitive receiver input stage
- › Can store unlimited number of transmitters
- › Accepts wide supply voltage, 7.5 – 28 Volts DC and operates on low current consumption
- › Crystal controlled for high stability and performance
- › Momentary, Latching and Security latching output modes can be selected by the user
- › SS version is available with an industry standard 6-pin connector and SST version is available with terminal blocks

DESCRIPTION

This Gigalink® receiver gives you two open collector outputs switching to ground with a capacity of 100mA 40 VDC each. The GLR43302SS version uses an industry standard female 6-pin connector allowing you to easily integrate a receiver into your applications.

This receiver is also compatible with the Relay H2 motherboards. This motherboard increases the output switching capacity to 35 Amps. This can be used for industrial applications such as heavy machinery or trucks. Included with the receiver is the Gigalink® programming cable.

TECHNICAL DATA

Supply Voltage	7.5 – 28 Volts DC. Can use Elsema DC power supply, 12PP1000
Current Consumption	11mA standby
Receiving Frequency	433.920MHz (other frequencies available on request)
Sensitivity	Better than 1µV (for output to switch on)
Output	Two open collectors, maximum switching 100mA / 40VDC Use optional Relay H2 motherboard to increase switching current to 35 Amps
Antenna	Elsema ANT 433MHz series
Dimensions	88 x 43 x 15mm
Compatible Transmitters	Elsema type GLT433 series

GLR433 RECEIVER

GLR43302 and GLR43302E

433MHz Gigalink® Receiver with Two Relay Outputs



GLR43302

GLR433 RECEIVER

FEATURES

- › Two channel receiver with relay outputs
- › Over 4 billion code combinations
- › Supply voltage can be AC or DC
- › Highly sensitive receiver input stage
- › Crystal controlled for high reliability
- › Can store unlimited number of transmitters
- › Modes include Momentary, Latching and Security Latching
- › E version available with C1020 case
- › Optional QM100 bracket available for easy mounting to cases or walls

DESCRIPTION

This Gigalink® receiver gives you two relay outputs that can switch currents up to 10 Amps each. There is an on-board switch to test each relay and a LED to indicate when the relay is “on”. The receiver has a power “on” LED to indicate that the correct supply voltage is connected.

The receiver’s micro-controller can store unlimited number of transmitters with a high security level using the encrypted 32-bit digital code. Included with the receiver is the Gigalink® programming cable.

TECHNICAL DATA

Supply Voltage	11 - 28 VAC/DC. Can use Elsema DC or AC power supply, 12PP1000 or 24PP
Current Consumption	16mA standby
Receiving Frequency	433.920MHz (other frequencies available on request)
Sensitivity	Better than 1µV (for relay output to switch on)
Relay Output	Two changeover relay outputs, rated at 10 Amps / 240VAC
Antenna	Elsema ANT 433MHz series
Dimensions	96 x 70 x 20mm
Compatible Transmitters	Elsema type GLT433 series

GLR43302240 and GLR43302240E

433MHz Gigalink® Receiver with 240VAC Supply connection and 2 Relay Outputs



GLR43302240

GLR43302240E

FEATURES

- › Two channel receiver with relay outputs
- › Over 4 billion code combinations
- › Supply voltage is 240 Volts AC
- › Highly sensitive receiver input stage
- › Crystal controlled for high reliability
- › Can store unlimited number of transmitters
- › Momentary, Latching and Security Latching output modes can be selected by the user
- › E version available with ABS case
- › Built-in test switch to activate relay
- › Optional QM150 bracket available for easy mounting to cases or walls

DESCRIPTION

This Gigalink® receiver can be connected directly to the mains supply, 240VAC. There is an on-board switch to test the relay and a LED to indicate when the relay is “on”. The receiver has a power “on” LED to indicate that the correct supply voltage is connected.

The receiver’s micro-controller can store unlimited number of transmitters with a high security level using the encrypted 32-bit digital code. Included with the receiver is the Gigalink® programming cable.

TECHNICAL DATA

Supply Voltage	240 VAC Mains
Current Consumption	2.2mA standby
Receiving Frequency	433.920MHz (other frequencies available on request)
Sensitivity	Better than 1µV (for the relay output to switch on)
Output	Two changeover relay outputs, rated at 16 amps / 240VAC
Antenna	Elsema ANT433 series
Dimensions	130 x 70 x 37mm
Compatible Transmitters	Elsema type GLT433 series

GLR43303 and GLR43303E

433MHz Gigalink® Receiver with Three Relay Outputs

GLR43303



FEATURES

- › Three channel receiver with relay outputs
- › Over 4 billion code combinations
- › Supply voltage can be AC or DC
- › Highly sensitive receiver input stage
- › Crystal controlled for high reliability
- › Can store unlimited number of transmitters
- › Modes include Momentary, Latching and Security Latching
- › E version available with C1020 case
- › Optional QM150 bracket available for easy mounting to cases or walls

DESCRIPTION

This Gigalink® receiver gives you three relay outputs that can switch currents up to 10 Amps each. There is an on-board switch to test each relay and a LED to indicate when the relay is “on”. The receiver has a power “on” LED to indicate that the correct supply voltage is connected.

The receiver’s micro-controller can store unlimited number of transmitters with a high security level using the encrypted 32-bit digital code. Included with the receiver is the Gigalink® programming cable.

TECHNICAL DATA

Supply Voltage	11 - 28 VAC/DC. Can use Elsema DC power supply 12PP1000 or 24PP
Current Consumption	16mA standby
Receiving Frequency	433.920MHz (other frequencies available on request)
Sensitivity	Better than 1µV (for relay output to switch on)
Relay Output	Three changeover relay outputs, rated at 10 Amps / 240VAC
Antenna	Elsema ANT 433MHz series
Dimensions	130 x 70 x 20mm
Compatible Transmitters	Elsema type GLT433 series

GLR43304 and GLR43304E

433MHz Gigalink® Receiver with Four Relay Outputs



GLR43304

FEATURES

- › Four channel receiver with relay outputs
- › Over 4 billion code combinations
- › Supply voltage can be AC or DC
- › Highly sensitive receiver input stage
- › Crystal controlled for high reliability
- › Can store unlimited number of transmitters
- › Modes include Momentary, Latching and Security Latching
- › E version available with C1020 case
- › Optional QM150 bracket available for easy mounting to cases or walls

DESCRIPTION

This Gigalink® receiver gives you four relay outputs that can switch currents up to 10 Amps each. There is an on-board switch to test each relay and a LED to indicate when the relay is “on”. The receiver has a power “on” LED to indicate that the correct supply voltage is connected.

The receiver’s micro-controller can store unlimited number of transmitters with a high security level using the encrypted 32-bit digital code. Included with the receiver is the Gigalink® programming cable.

TECHNICAL DATA

Supply Voltage	11 - 28 VAC/DC. Can use Elsema DC power supply 12PP1000 or 24PP
Current Consumption	16mA standby
Receiving Frequency	433.920MHz (other frequencies available on request)
Sensitivity	Better than 1µV (for relay output to switch on)
Relay Output	Four changeover relay outputs, rated at 10 Amps / 240VAC
Antenna	Elsema ANT 433MHz series
Dimensions	130 x 70 x 20mm
Compatible Transmitters	Elsema type GLT433 series

GLR43304240 and GLR43304240E

433MHz Gigalink® Receiver with 240VAC Supply connection and 4 Relay Outputs

GLR43304240



FEATURES

- › Four channel receiver with relay outputs
- › Over 4 billion code combinations
- › Supply voltage is 240 Volts AC
- › Highly sensitive receiver input stage
- › Crystal controlled for high reliability
- › Can store unlimited number of transmitters
- › Modes include Momentary, Latching and Security Latching
- › E version available with C1020 case
- › Optional QM150 bracket available for easy mounting to cases or walls

DESCRIPTION

This Gigalink® receiver gives you four relay outputs that can switch currents up to 16 Amps each. There is an on-board switch to test each relay and a LED to indicate when the relay is “on”. The receiver has a power “on” LED to indicate that the correct supply voltage is connected.

The receiver’s micro-controller can store unlimited number of transmitters with a high security level using the encrypted 32-bit digital code. Included with the receiver is the Gigalink® programming cable.

TECHNICAL DATA

Supply Voltage	240 VAC Mains with optional 120 VAC for export markets
Current Consumption	2.5mA standby
Receiving Frequency	433.920MHz (other frequencies available on request)
Sensitivity	Better than 1µV (for relay output to switch on)
Relay Output	Four changeover relay outputs, rated at 16 amps / 240VAC
Antenna	Elsema ANT433 series
Dimensions	160 x 70 x 30mm
Compatible Transmitters	Elsema type GLT433 series

GLR43308POS

433MHz Gigalink® Receiver with Eight Outputs Switching to Positive



FEATURES

- › Eight channel receiver
- › Over 4 billion code combinations
- › Supply voltage can be AC or DC
- › Highly sensitive receiver input stage
- › Crystal controlled for high reliability
- › Can store unlimited number of transmitters
- › Modes include Momentary, Latching and Security Latching
- › E version available with C1015 or C1020 case
- › Optional QM100 bracket available for easy mounting to cases or walls

DESCRIPTION

This Gigalink® receiver gives you eight positive switching outputs. Each output can be up to 50 Volts and a drive current of 120mA. The outputs are protected with a diode to stop any EMF or transient from getting to the receiver.

The receiver's micro-controller can store unlimited number of transmitters with a high security level using the encrypted 32-bit digital code. Included with the receiver is the Gigalink® programming cable.

TECHNICAL DATA

Supply Voltage	11 - 28 VAC/DC. Can use Elsema DC power supply 12PP1000 or 24PP
Current Consumption	9mA standby, 25mA if all outputs "On"
Receiving Frequency	433.920MHz (other frequencies available on request)
Sensitivity	Better than 1µV (for the output to switch on)
Output	50 Volts, 120mA positive switching with all outputs "On"
Antenna	Elsema ANT 433MHz series antennas or piece of approximately 690mm long wire for short range applications
Dimensions	96 x 70 x 15mm
Compatible Transmitters	All Elsema type 433MHz GLT-... series

GLR43308 and GLR43308E

433MHz Gigalink® Receiver with Eight Open Collector Outputs



FEATURES

- › Eight channel receiver with open collector outputs
- › Over 4 billion code combinations
- › Supply voltage can be AC or DC
- › Highly sensitive receiver input stage
- › Crystal controlled for high reliability
- › Can store unlimited number of transmitters
- › Modes include Momentary, Latching and Security Latching
- › E version available with C1015 or C1020 case
- › Optional QM100 bracket available for easy mounting to cases or walls

GLR433 RECEIVER

DESCRIPTION

This Gigalink® receiver gives you eight open collector outputs switching to ground with a capacity of 125mA 40 VDC each. Each open collector output is protected with a diode to stop any EMF from getting to the receiver.

The receiver's micro-controller can store unlimited number of transmitters with a high security level using the encrypted 32-bit digital code. Included with the receiver is the Gigalink® programming cable.

TECHNICAL DATA

Supply Voltage	11 - 28 VAC/DC. Can use Elsema DC or AC power supply, 12PP1000 or 24PP
Current Consumption	16mA standby
Receiving Frequency	433.920MHz (other frequencies available on request)
Sensitivity	Better than 1µV (for the output to switch on)
Output	Eight open collector, maximum switching 125mA / 40VDC
Antenna	Elsema ANT 433MHz series
Dimensions	95 x 70 x 15mm
Compatible Transmitters	Elsema type GLT433 series

GLR43308R and GLR43308RE

433MHz Gigalink® Receiver with Supply connection and Eight Relay Outputs

GLR43308R



FEATURES

- › Eight channel receiver with relay outputs
- › Over 4 billion code combinations
- › Supply voltage can be AC or DC
- › Highly sensitive receiver input stage
- › Crystal controlled for high reliability
- › Can store unlimited number of transmitters
- › Modes include Momentary, Latching and Security Latching
- › E version available with C1217 case

DESCRIPTION

This Gigalink® receiver gives you eight relay outputs that can switch currents up to 10 Amps each. There is an on-board LED to indicate when the relay is “on”. The receiver has a power “on” LED to indicate that the correct supply voltage is connected.

The receiver’s micro-controller can store unlimited number of transmitters with a high security level using the encrypted 32-bit digital code. Included with the receiver is the Gigalink® programming cable.

TECHNICAL DATA

Supply Voltage	11 - 28 VAC/DC. Can use Elsema DC power supply 12PP1000 or 24PP
Current Consumption	16mA standby
Receiving Frequency	433.920MHz (other frequencies available on request)
Sensitivity	Better than 1µV (for relay output to switch on)
Relay Output	Eight changeover relay outputs, rated at 10 Amps / 240VAC
Antenna	Elsema ANT 433MHz series
Dimensions	130 x 95 x 42mm
Compatible Transmitters	Elsema type GLT433 series

MCT91501, MCT91502, MCT91503, MCT91504 MCT91501SMA, MCT91502SMA, MCT91503SMA and MCT91504SMA

915 – 928 MHz Hand-held Transmitter with Fast Frequency-hopping



MCT91504



MCT91504SMA

FEATURES

- › Available with 1, 2, 3 or 4 channels, 8, 12 and 16-channels is available with the larger case
- › 12-way dipswitch (4096 codes) or Encrypted (over 16 million codes)
- › Fast Frequency-hopping operates on several frequencies for interference or jamming immunity
- › SMA version allows connection of an external antenna for long range applications. More than 350 metres
- › Return acknowledgment signal or maintain link feature
- › Available with customised front label, brand it with your own company logo. NL Version
- › Available with no case to allow OEM manufacturers to use their own case. NC Version

DESCRIPTION

The transmitters use fast frequency-hopping (FFH) to allow up to eight transmitters to be used in the same area. No interference or jamming will occur. The FFH technology is usually used in very expensive equipment with military or medical applications. Elsema has developed a world-first low-cost lightweight hand-held FFH transmitter.

TECHNICAL DATA

Power Source	9 Volt battery	
Current Consumption	55mA (typical). Only during transmission	
Operating Frequency	915 to 928MHz	
Dimensions	96 x 55 x 20 mm (with case)	64 x 52 x 12 mm (No Case, NC)
Useable Operating Range	Up to 150 metres or more than 350 metres using the SMA version	
Compatible Receivers	All Elsema type MCR915 series	

ACCESSORY



9 VOLT DURACELL
BATTERY
PART NO: 6LR61



STYLISH LEATHER
POUCH
PART NO.: LP

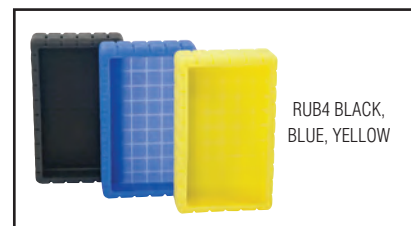

RUB4 BLACK,
BLUE, YELLOW

MCT91508, MCT91512 and MCT91516 MCT91508SMA, MCT91512SMA and MCT91516SMA

915 – 928MHz Hand-held Transmitter with Fast Frequency-hopping



MCT91508

MCT91512

MCT91516

FEATURES

- › Available with 8, 12, or 16 channels, 1, 2, 3 and 4-channels is available with the smaller case
- › 12-way dipswitch (4096 codes) or Encrypted (over 16 million codes)
- › Fast Frequency-hopping operates on several frequencies for interference or jamming immunity
- › Return acknowledgment signal or maintain link feature
- › Available with customised front label, brand it with your own company logo. NL Version
- › Available with no case to allow OEM manufacturers to use their own case. NC Version
- › SMA version allows connection of an external antenna for long range applications. More than 350 metres

MCT TRANSMITTER

TECHNICAL DATA

Power Source	9 Volt battery	
Current Consumption	55mA (typical). Only during transmission	
Operating Frequency	915 to 928MHz	
Dimensions	130 x 67 x 27mm (with case)	81 x 56 x 12mm (No Case, NC)
Useable Operating Range	Up to 150 metres or more than 350 metres using the SMA version	
Compatible Receivers	All Elsema type MCR915 series	

ACCESSORY



9 VOLT DURACELL
BATTERY
PART NO: 6LR61



SIL08

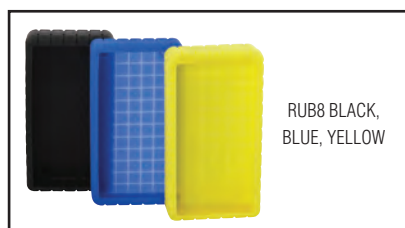

RUB8 BLACK,
BLUE, YELLOW

MCR91501R and MCR91501RE

915MHz Multicode Receiver with Relay Output

MCR91501R



FEATURES

- › One relay output
- › Accepts wide supply voltage and operates on low current consumption
- › Dual coding system, 12-way dipswitch (4096 codes) or Encrypted (over 16 million codes)
- › Fast Frequency-hopping operates on several frequencies for interference or jamming immunity
- › Momentary and Latching modes can be selected by the user
- › Optional QM100 bracket available for easy mounting to cases or walls
- › E version available with C1020 case



MCR91501RE

DESCRIPTION

This receiver gives you a single relay output with a contact rating of 10 Amps at 240VAC. Using pluggable terminal blocks, high quality SMA antenna connector and the quick mount (QM100) makes for easy installation. Also available in an IP66 rated weatherproof case, MCR91501RE.

The receivers use fast frequency-hopping (FFH) to allow up to eight receivers to be used in the same area. No interference or jamming will occur. The FFH technology is usually used in very expensive equipment with military or medical applications.

The receivers use a dual digital coding called Multicode Technology (MC). This MC digital coding can be either the 12-way dipswitch or the encrypted coding.

The combination of FFH and MC technology brings you a very sophisticated receiver yet easy to use.

TECHNICAL DATA

Supply Voltage	10 - 28 VAC/DC. Can use Elsema DC or AC power supply, 12PP1000 or 24PP
Current Consumption	16mA standby at 24VDC
Receiving Frequency	915 to 928MHz (other frequencies available for different countries)
Sensitivity	Better than 1 μ V (for relay output to switch on)
Output	Changeover relay output, rated at 10 Amps / 240VAC
Antenna	Elsema ANT 915MHz series
Dimensions	99 x 70 x 27mm
Compatible Transmitters	Elsema type MCT915 series

MCR91502PT and MCR91502P

915MHz Multicode Receiver with Two Open Collector Outputs

MCR91502P

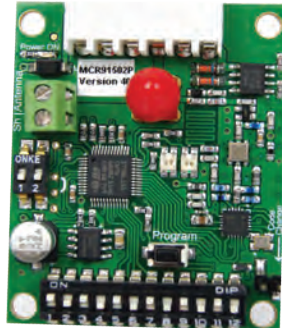
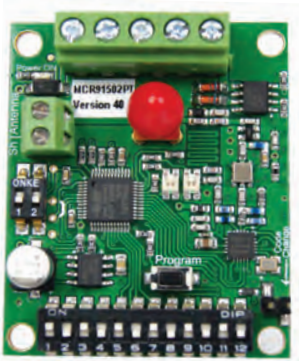

MCR91502PT

FEATURES

- › Two open collector outputs
- › Accepts wide supply voltage, 7.0 – 36 Volts DC and operates on low current consumption
- › Dual coding system, 12-way dipswitch (4096 codes) or Encrypted (over 16 million codes)
- › Fast Frequency-hopping operates on several frequencies for interference or jamming immunity
- › Momentary and Latching modes can be selected by the user
- › Available with an industry standard 6-pin connector or MCR91502PT is with terminal block connection for easy wiring

DESCRIPTION

This is our smallest receiver measuring 55 x 44 x 13 mm. Small but still very powerful using the latest Mosfet technology to give you two outputs with high switching current of 2 Amps at 40VDC each.

The receivers use fast frequency-hopping (FFH) to allow up to eight receivers to be used in the same area. No interference or jamming will occur. The FFH technology is usually used in very

expensive equipment with military or medical applications.

The receivers use a dual digital coding called Multicode Technology (MC). This MC digital coding can be either the 12-way dipswitch or the encrypted coding.

The combination of FFH and MC technology brings you a very sophisticated receiver yet easy to use.

TECHNICAL DATA

Supply Voltage	7 - 36 Volts DC. Can use Elsema DC power supply 12PP1000
Current Consumption	26mA standby
Receiving Frequency	915 to 928MHz (other frequencies available for different countries)
Sensitivity	Better than 2 μ V (for output to switch on)
Output	Two open collector, maximum switching 2 Amps / 40VDC
Antenna	Elsema ANT 915MHz series
Dimensions	55 x 44 x 13mm
Compatible Transmitters	Elsema type MCT915 series

MCR91502R and MCR91502RE

915MHz Multicode Receiver with Two Relay Outputs

MCR91502R



FEATURES

- › Two relay outputs
- › Accepts wide supply voltage and operates on low current consumption
- › Dual coding system, 12-way dipswitch (4096 codes) or Encrypted (over 16 million codes)
- › Fast Frequency-hopping operates on several frequencies for interference or jamming immunity
- › Momentary and Latching modes can be selected by the user
- › Optional QM100 bracket available for easy mounting to cases or walls
- › E version available with C1020 case



MCR91502RE

DESCRIPTION

This receiver gives you two relay outputs with a contact rating of 10 Amps at 240VAC for each relay. Using pluggable terminal blocks, high quality SMA antenna connector and the quick mount (QM100) makes for easy installation. Also available in an IP66 rated weatherproof case, MCR91502RE.

The receivers use fast frequency-hopping (FFH) to allow up to eight receivers to be used in the same area. No interference or jamming will occur. The FFH technology is usually used in very expensive equipment with military or medical applications.

The receivers use a dual digital coding called Multicode Technology (MC). This MC digital coding can be either the 12-way dipswitch or the encrypted coding.

The combination of FFH and MC technology brings you a very sophisticated receiver yet easy to use.

TECHNICAL DATA

Supply Voltage	10 - 28 VAC/DC. Can use Elsema DC or AC power supply, 12PP1000 or 24PP
Current Consumption	16mA standby at 24VDC
Receiving Frequency	915 to 928MHz (other frequencies available for different countries)
Sensitivity	Better than 1 μ V (for relay output to switch on)
Output	Two changeover relay outputs, rated at 10 Amps / 240VAC
Antenna	Elsema ANT 915MHz series
Dimensions	99 x 70 x 27mm
Compatible Transmitters	Elsema type MCT915 series

MCR91503R and MCR91503RE

915MHz Multicode Receiver with Three Relay Outputs

MCR91503R

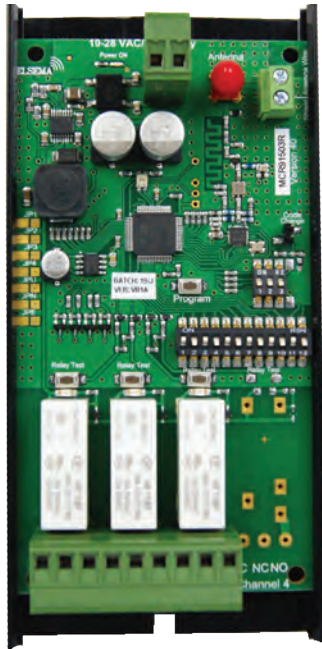

MCR91503RE

FEATURES

- › Three relay outputs
- › Accepts wide supply voltage and operates on low current consumption
- › Dual coding system, 12-way dipswitch (4096 codes) or Encrypted (over 16 million codes)
- › Fast Frequency-hopping operates on several frequencies for interference or jamming immunity
- › Momentary and Latching modes can be selected by the user
- › Optional QM150 bracket available for easy mounting to cases or walls
- › E version available with C1020 case

DESCRIPTION

This receiver gives you three relay outputs with a contact rating of 10 Amps at 240VAC for each relay. Using pluggable terminal blocks, high quality SMA antenna connector and the quick mount (QM150) makes for easy installation. Also available in an IP66 rated weatherproof case, MCR91503RE.

The receivers use fast frequency-hopping (FFH) to allow up to eight receivers to be used in the same area. No interference or jamming will occur. The FFH technology is usually used in very expensive equipment with military or medical applications.

The receivers use a dual digital coding called Multicode Technology (MC). This MC digital coding can be either the 12-way dipswitch or the encrypted coding. The combination of FFH and MC technology brings you a very sophisticated receiver yet easy to use.

TECHNICAL DATA

Supply Voltage	10 - 28 VAC/DC. Can use Elsema DC or AC power supply, 12PP1000 or 24PP
Current Consumption	16mA standby at 24VDC
Receiving Frequency	915 to 928MHz (other frequencies available for different countries)
Sensitivity	Better than 1µV (for relay output to switch on)
Output	Three changeover relay outputs, rated at 10 Amps / 240VAC
Antenna	Elsema ANT 915MHz series
Dimensions	130 x 70 x 27mm
Compatible Transmitters	Elsema type MCT915 series

MCR91504R and MCR91504RE

915MHz Multicode Receiver with Four Relay Outputs

MCR91504R



MCR91504RE

FEATURES

- › Four relay outputs
- › Accepts wide supply voltage and operates on low current consumption
- › Dual coding system, 12-way dipswitch (4096 codes) or Encrypted (over 16 million codes)
- › Fast Frequency-hopping operates on several frequencies for interference or jamming immunity
- › Momentary and Latching modes can be selected by the user
- › Optional QM150 bracket available for easy mounting to cases or walls
- › E version available with C1020 case

DESCRIPTION

This receiver gives you four relay outputs with a contact rating of 10 Amps at 240VAC for each relay. Using pluggable terminal blocks, high quality SMA antenna connector and the quick mount (QM150) makes for easy installation. Also available in an IP66 rated weatherproof case, MCR91504RE.

The receivers use fast frequency-hopping (FFH) to allow up to eight receivers to be used in the same area. No interference or jamming will occur. The FFH technology is usually used in very expensive equipment with military or medical applications.

The receivers use a dual digital coding called Multicode Technology (MC). This MC digital coding can be either the 12-way dipswitch or the encrypted coding.

The combination of FFH and MC technology brings you a very sophisticated receiver yet easy to use.

TECHNICAL DATA

Supply Voltage	10 - 28 VAC/DC. Can use Elsema DC or AC power supply, 12PP1000 or 24PP
Current Consumption	16mA standby at 24VDC
Receiving Frequency	915 to 928MHz (other frequencies available for different countries)
Sensitivity	Better than 1µV (for relay output to switch on)
Output	Four changeover relay outputs, rated at 10 Amps / 240VAC
Antenna	Elsema ANT 915MHz series
Dimensions	130 x 70 x 27mm
Compatible Transmitters	Elsema type MCT915 series

MCR91508POS

915MHz Multicode Receiver with Eight Outputs Switching to Positive

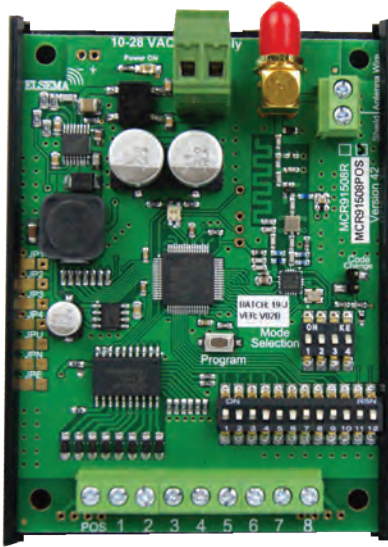

FEATURES

- › Eight channel receiver
- › Accepts wide supply voltage and operates on low current consumption
- › Dual coding system, 12-way dipswitch (4096 codes) or Encrypted (over 16 million codes)
- › Fast Frequency-hopping operates on several frequencies to avoid interference or jamming immunity
- › Momentary, latching or security latching modes can be selected by the user
- › Optional QM100 bracket available for easy mounting to cases or walls
- › E version available with C1020 case

DESCRIPTION

This receiver has eight outputs. Each output can be up to 50 Volts and a drive current of 120mA. The receiver includes a mounting bracket (QM100) for easy mounting. Also available in an IP66 rated weatherproof case, MCR91508POSE.

The receivers use fast frequency-hopping (FFH) to allow up to eight receivers to be used in the same area. No interference or jamming will occur. The FFH technology is used in very

expensive equipment with military or medical applications. The receivers use a dual digital coding called Multitude Technology (MC). This MC digital coding can be either the 12-way dipswitch or the encrypted coding.

The combination of FFH and MC technology brings you a very sophisticated receiver yet easy-to-use.

TECHNICAL DATA

Supply Voltage	11 - 28 VAC/DC. Can use Elsema AC power supply PP12 or PP24
Current Consumption	16mA standby at 24VDC
Receiving Frequency	915 to 928MHz
Sensitivity	1µV (for output to switch on)
Output	50 Volts, 120mA positive switching with all outputs "On"
Antenna	ANT915S-SMA for long range applications or piece of approximately 160mm wire for short range applications
Dimensions	95 x 70 x 27mm
Compatible Transmitters	All Elsema type MCT915xx series

MCR91508SS and MCR91508SSE

915MHz Multicode Receiver with Eight Open Collector Outputs

MCR91508SS

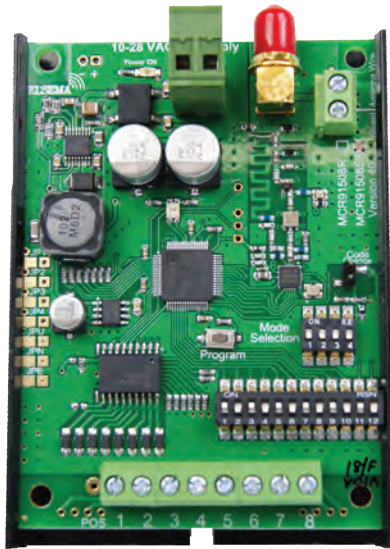

MCR91508SSE

FEATURES

- › Eight open collector outputs
- › Accepts wide supply voltage and operates on low current consumption
- › Dual coding system, 12-way dipswitch (4096 codes) or Encrypted (over 16 million codes)
- › Fast Frequency-hopping operates on several frequencies for interference or jamming immunity
- › Momentary, Latching and Security Latching modes can be selected by the user
- › Optional QM100 bracket available for easy mounting to cases or walls
- › E version available with C1020 case

DESCRIPTION

This receiver has eight open collector outputs that switch to ground. Each output can switch 125mA / 40VDC. The receiver includes a mounting bracket (QM100) for easy mounting. Also available in an IP66 rated weatherproof case, MCR91508SSE.

The receivers use fast frequency-hopping (FFH) to allow up to eight receivers to be used in the same area. No interference or jamming will occur. The FFH technology is usually used in very expensive equipment with military or medical applications.

The receivers use a dual digital coding called Multicode Technology (MC). This MC digital coding can be either the 12-way dipswitch or the encrypted coding.

The combination of FFH and MC technology brings you a very sophisticated receiver yet easy to use.

TECHNICAL DATA

Supply Voltage	10 - 28 VAC/DC. Can use Elsema DC or AC power supply, 12PP1000 or 24PP
Current Consumption	16mA standby at 24VDC
Receiving Frequency	915 to 928MHz (other frequencies available for different countries)
Sensitivity	Better than 1µV (for output to switch on)
Output	Eight open collectors, maximum switching 125mA / 40VDC
Antenna	Elsema ANT 915MHz series
Dimensions	95 x 70 x 27mm
Compatible Transmitters	Elsema type MCT915 series

MCR91508R and MCR91508RE

915MHz Multicode Receiver with Eight Relay Outputs

MCR91508R

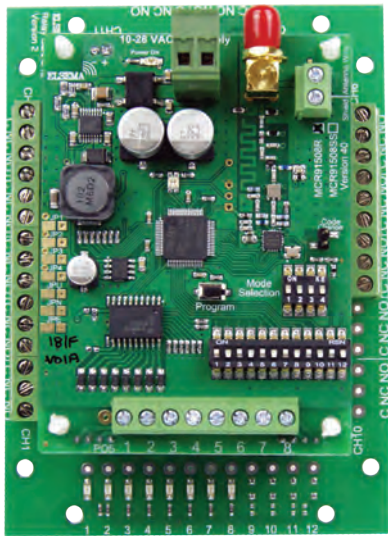

FEATURES

- › Eight relay outputs
- › Accepts wide supply voltage and operates on low current consumption
- › Dual coding system, 12-way dipswitch (4096 codes) or Encrypted (over 16 million codes)
- › Fast Frequency-hopping operates on several frequencies for interference or jamming immunity
- › Momentary, Latching and Security Latching modes can be selected by the user
- › E version available with C1520 case

DESCRIPTION

This receiver gives you eight relay outputs with a contact rating of 10 Amps at 240VAC for each relay. The receiver can be programmed with unlimited number of transmitters and simultaneous channel reception is possible. Also available in an IP66 rated weatherproof case, MCR91508RE.

The receivers use fast frequency-hopping (FFH) to allow up to eight receivers to be used in the same area. No interference or jamming will occur. The FFH technology is usually used in very expensive equipment with military or medical applications.

The receivers use a dual digital coding called Multicode technology (MC). This MC digital coding can be either the 12-way dipswitch or the encrypted coding.

The combination of FFH and MC technology brings you a very sophisticated receiver yet easy to use.

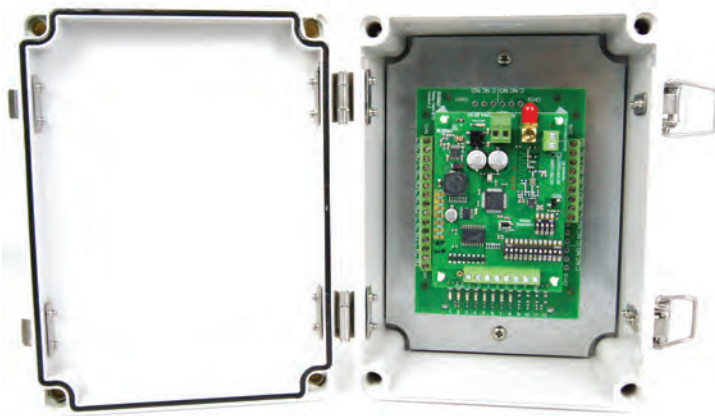

MCR91508RE

TECHNICAL DATA

Supply Voltage	10 - 28 VAC/DC. Can use Elsema DC or AC power supply, 12PP1000 or 24PP
Current Consumption	16mA standby at 24VDC
Receiving Frequency	915 to 928MHz (other frequencies available for different countries)
Sensitivity	Better than 1µV (for relay output to switch on)
Output	Eight changeover relay outputs, rated at 10 Amps / 240VAC
Antenna	Elsema ANT 915MHz series
Dimensions	130 x 94 x 55mm
Compatible Transmitters	Elsema type MCT915 series

MCR91512SS and MCR91512SSE

915MHz Multicode Receiver with Twelve Open Collector Outputs

MCR91512SS

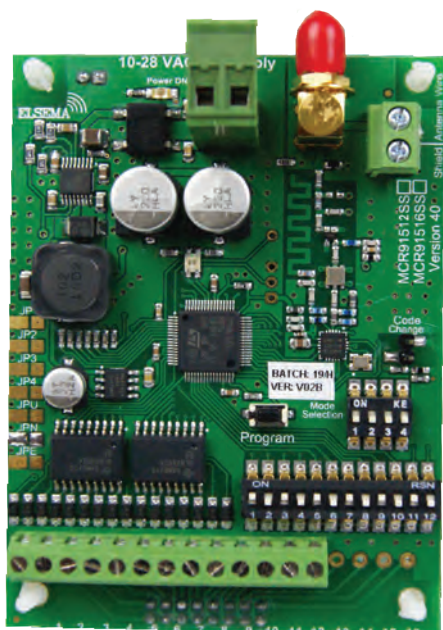

MCR91512SSE

FEATURES

- › Twelve open collector outputs
- › Accepts wide supply voltage and operates on low current consumption
- › Dual coding system, 12-way dipswitch (4096 codes) or Encrypted (over 16 million codes)
- › Fast Frequency-hopping operates on several frequencies for interference or jamming immunity
- › Momentary, Latching and Security Latching modes can be selected by the user
- › Optional QM100 bracket available for easy mounting to cases or walls
- › E version available with C1020 case

DESCRIPTION

This receiver has twelve open collector outputs that switch to ground. Each output can switch 125mA / 40VDC. The receiver includes a mounting bracket (QM100) for easy mounting. Also available in an IP66 rated weatherproof case, MCR91512SSE.

The receivers use fast frequency-hopping (FFH) to allow up to eight receivers to be used in the same area. No interference or jamming will occur. The FFH technology is usually used in very expensive equipment with military or medical applications.

The receivers use a dual digital coding called Multicode Technology (MC). This MC digital coding can be either the 12-way dipswitch or the encrypted coding.

The combination of FFH and MC technology brings you a very sophisticated receiver yet easy to use.

TECHNICAL DATA

Supply Voltage	10 - 28 VAC/DC. Can use Elsema DC or AC power supply, 12PP1000 or 24PP
Current Consumption	16mA standby at 24VDC
Receiving Frequency	915 to 928MHz (other frequencies available for different countries)
Sensitivity	Better than 1µV (for output to switch on)
Output	Twelve open collectors, maximum switching 125mA / 40VDC
Antenna	Elsema ANT 915MHz series
Dimensions	95 x 70 x 27mm
Compatible Transmitters	Elsema type MCT915 series

MCR91512R and MCR91512RE

915MHz Multicode Receiver with Twelve Relay Outputs

MCR91512R

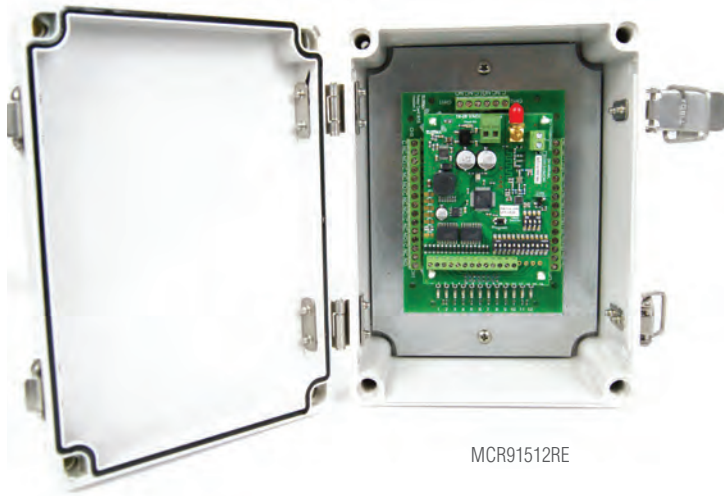
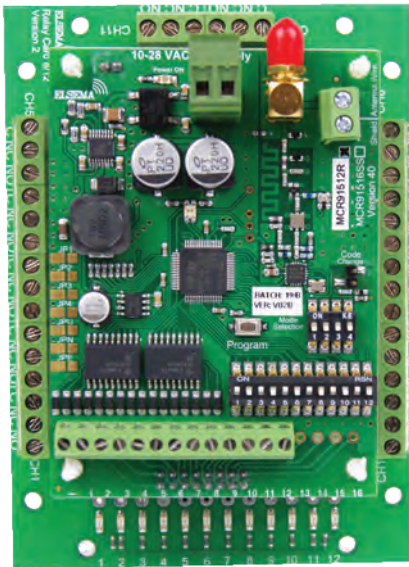

MCR91512RE

FEATURES

- › Twelve relay outputs
- › Accepts wide supply voltage and operates on low current consumption
- › Dual coding system, 12-way dipswitch (4096 codes) or Encrypted (over 16 million codes)
- › Fast Frequency-hopping operates on several frequencies for interference or jamming immunity
- › Momentary, Latching and Security Latching modes can be selected by the user
- › E version available with C1520 case

DESCRIPTION

This receiver gives you twelve relay outputs with a contact rating of 10 Amps at 240VAC for each relay. The receiver can be programmed with unlimited number of transmitters and simultaneous channel reception is possible. Also available in an IP66 rated weatherproof case, MCR91512RE.

The receivers use fast frequency-hopping (FFH) to allow up to eight receivers to be used in the same area. No interference or jamming will occur. The FFH technology is usually used in very expensive equipment with military or medical applications.

The receivers use a dual digital coding called Multicode Technology (MC). This MC digital coding can be either the 12-way dipswitch or the encrypted coding.

The combination of FFH and MC technology brings you a very sophisticated receiver yet easy to use.

TECHNICAL DATA

Supply Voltage	10 - 28 VAC/DC. Can use Elsema DC or AC power supply, 12PP1000 or 24PP
Current Consumption	16mA standby at 24VDC
Receiving Frequency	915 to 928MHz (other frequencies available for different countries)
Sensitivity	Better than 1µV (for relay output to switch on)
Output	Twelve changeover relay outputs, rated at 10 Amps / 240VAC
Antenna	Elsema ANT 915MHz series
Dimensions	130 x 94 x 55mm
Compatible Transmitters	Elsema type MCT915 series

MCR91516SS and MCR91516SSE

915MHz Multicode Receiver with Sixteen Open Collector Outputs

MCR91516SS

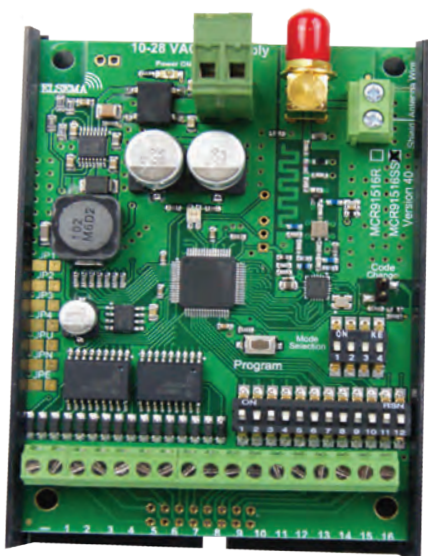

FEATURES

- › Sixteen open collector outputs
- › Accepts wide supply voltage and operates on low current consumption
- › Dual coding system, 12-way dipswitch (4096 codes) or Encrypted (over 16 million codes)
- › Fast Frequency-hopping operates on several frequencies for interference or jamming immunity
- › Momentary, Latching and Security Latching modes can be selected by the user
- › Optional QM100 bracket available for easy mounting to cases or walls
- › E version available with C1020 case

DESCRIPTION

This receiver has sixteen open collector outputs that switch to ground. Each output can switch 125mA / 40VDC. The receiver includes a mounting bracket (QM100) for easy mounting. Also available in an IP66 rated weatherproof case, MCR91516SSE.

The receivers use fast frequency-hopping (FFH) to allow up to eight receivers to be used in the same area. No interference or jamming will occur. The FFH technology is usually used in very expensive equipment with military or medical applications.

The receivers use a dual digital coding called Multicode Technology (MC). This MC digital coding can be either the 12-way dipswitch or the encrypted coding.

The combination of FFH and MC technology brings you a very sophisticated receiver yet easy to use.



MCR91516SSE

TECHNICAL DATA

Supply Voltage	10 - 28 VAC/DC. Can use Elsema DC or AC power supply, 12PP1000 or 24PP
Current Consumption	16mA standby at 24VDC
Receiving Frequency	915 to 928MHz (other frequencies available for different countries)
Sensitivity	Better than 1µV (for output to switch on)
Output	Sixteen open collectors, maximum switching 125mA / 40VDC
Antenna	Elsema ANT 915MHz series
Dimensions	95 x 70 x 27mm
Compatible Transmitters	Elsema type MCT915 series

MCR91516R and MCR91516RE

915MHz Multicode Receiver with Sixteen Relay Outputs

MCR91516R

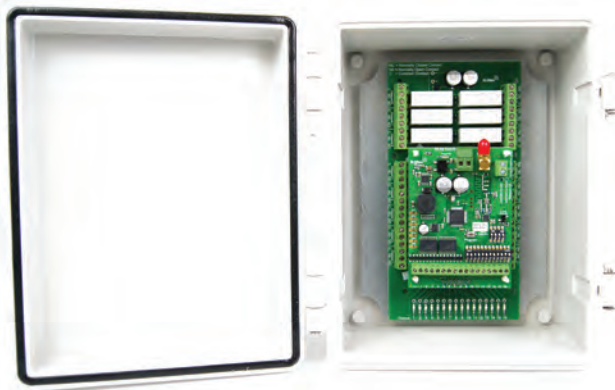

MCR91516SSE

FEATURES

- › Sixteen relay outputs
- › Accepts wide supply voltage and operates on low current consumption
- › Dual coding system, 12-way dipswitch (4096 codes) or Encrypted (over 16 million codes)
- › Fast Frequency-hopping operates on several frequencies for interference or jamming immunity
- › Momentary, Latching and Security Latching modes can be selected by the user
- › E version available with C1722 case

DESCRIPTION

This receiver has sixteen relay outputs with a contact rating of 10 Amps at 240VAC for each relay. The receiver can be programmed with unlimited number of transmitters and simultaneous channel reception is possible. Also available in an IP66 rated weatherproof case, MCR91516RE.

The receivers use fast frequency-hopping (FFH) to allow up to eight receivers to be used in the same area. No interference or jamming will occur. The FFH technology is usually used in very expensive equipment with military or medical applications.

The receivers use a dual digital coding called Multicode Technology (MC). This MC digital coding can be either the 12-way dipswitch or the encrypted coding.

The combination of FFH and MC technology brings you a very sophisticated receiver yet easy to use.

TECHNICAL DATA

Supply Voltage	10 - 28 VAC/DC. Can use Elsema DC or AC power supply, 12PP1000 or 24PP
Current Consumption	16mA standby at 24VDC
Receiving Frequency	915 to 928MHz (other frequencies available for different countries)
Sensitivity	Better than 1 μ V (for relay output to switch on)
Output	Sixteen changeover relay outputs, rated at 10 Amps / 240VAC
Antenna	Elsema ANT 915MHz series
Dimensions	185 x 94 x 55mm
Compatible Transmitters	Elsema type MCT915 series

G-2025

4G compatible GSM Gate Opener



FEATURES

- › Up to 999 users
- › 4G network compatible
- › Built-in battery back-up
- › Switches relay with free call from mobile phone or land line
- › Only authorised numbers can operate the G-2025
- › No call charges
- › Operates from anywhere if 4G network is available. Unlimited range!
- › Ignores unauthorised numbers
- › Authorised numbers easily entered by PC Software
- › SMS confirmation of relay switching
- › Secure and password protected
- › 12 Volt DC power pack included

DESCRIPTION

The G-2025 works on latest 4G technology and can handle up-to 999 users. All you need is to insert a valid SIM card and program phone numbers of all users through the PC software or through simple SMS text commands. When an authorised user makes a call to the receiver, it rejects the call and activates a relay. Since the call is rejected, the user is not charged for the call.

The G-2025 works on 4G network therefore the receiver can be activated from anywhere in the country where mobile network is available. For example you can open your gate or switch on your kitchen lights in Sydney from Melbourne by making a call from your mobile phone and without getting charged. It is portable and as simple as making a call.

TECHNICAL DATA

Power Source	12 Volts DC
Network	Compatible with Telstra and Vodafone
Outputs	Common (C) and Normally Open (NO) relay outputs rated at 3A, 240VAC
Inputs	1 Digital Input, when activated can send SMS message
Dimensions	95 x 95 x 35mm

SP5, SP10, SP20, SP40, SP40-24 and SP60

High Efficiency 5, 10, 20, 40 and 60 Watt Solar Panels



FEATURES

- › 20 years 80% power guarantee, 10 years 90% power guarantee
- › High efficiency, monocrystalline silicon solar cells
- › Uses high transparency 3.2mm tempered low iron glass
- › Improved low-light performance
- › Anodized aluminum alloy frame

DESCRIPTION

Elsema's SP series of solar panels provides you with an eco-friendly solution to supply power. Typical applications include:

- › Automatic gates and doors
- › Water pumping
- › Wireless telemetry
- › Lighting and signage
- › Transmitter or receiver remote stand-alone systems

TECHNICAL DATA				High Voltage		
Model	SP5	SP10	SP20	SP40	SP40-24	SP60
Rated Power (Watts)	5 Watts	10 Watts	20 Watts	40 Watts	40 Watts	60 Watts
V_{mp} (Volts)	17.8V	17.8V	17.8V	17.8V	35.5V	17.8V
I_{mp} (Amps)	0.28 A	0.56 A	1.12 A	2.25 A	1.13 A	3.37 A
V_{oc} (Volts)	22.3 V	22.3 V	22.3 V	22.3 V	43.1 V	22.3 V
I_{sc} (Amps)	0.30 A	0.61 A	1.21 A	2.43 A	1.85 A	3.64 A
Dimension (mm)	250 x 185 x 15	415 x 185 x 18	470 x 345 x 25	550 x 505 x 25	670x 570 x 35	770 x 505 x 30
Weight (kg)	0.5	1.0	2.0	3.5	4.6	5.0

Antennas

Elsema has a wide selection of antennas manufactured by our RF engineers using the latest technology and test equipment from Rohde & Schwarz. We have our standard antennas on 915MHz, 433MHz and 151MHz that are always in stock. Antennas come on different frequency bands, connectors or coaxial cables can be designed to meet specific customer requirements.

To select the correct antenna you will need to match the antenna frequency to the equipment you are using. Most of Elsema's radio equipment is on 915MHz, 433MHz and 151MHz. For the higher frequencies such as 433MHz and 915MHz it is important that the coaxial cable is low loss and is terminated with a high quality connector.

As a general rule we have used high quality SMA connectors for frequencies above 300MHz. For frequencies below 300MHz the PL259 and the SO239 is used. We do not use the PL259 and the SO239 on frequencies above 300MHz as this connector does not work well above 300MHz. Other connectors available on special requests are N, BNC, MCX and MMCX.

Other considerations in selecting the correct antenna is the gain, SWR and coaxial cable.

Antenna gain is often measured with respect to a hypothetical antenna that radiates equally in all directions, an isotropic radiator. This gain is in decibels called dBi. The antenna gain can also be measured in dBd which is equal to dBi - 2.15.

The SWR is a measure of the amount of mismatch between the load (Antenna) and the transmission line's impedance. A SWR of 1 is a perfect match which occurs on a transmission line where there are no reflections. An SWR less than 1.5: 1 is considered good and a SWR greater than 2 : 1 is usually unacceptable. This may indicate a problem with the antenna. Refer to the table to convert SWR to power transmitted or reflected power.

All coaxial cables have attenuation. Using good quality coaxial will minimize the loss in the coaxial cable. Refer to the coaxial cable data table to compare common types of coaxial cables.



Effects of VSWR on Transmitted Power

VSWR	Return Loss dB	Power Transmitted %	Reflected Power %
1.00		100.0	0.0
1.01	46.1	100.0	0.0
1.02	40.1	100.0	0.0
1.03	36.6	100.0	0.0
1.04	34.2	100.0	0.0
1.05	32.3	99.9	0.1
1.06	30.7	99.9	0.1
1.07	29.4	99.9	0.1
1.08	28.3	99.9	0.1
1.09	27.3	99.8	0.2
1.10	26.4	99.8	0.2
1.11	25.7	99.7	0.3
1.12	24.9	99.7	0.3
1.13	24.3	99.6	0.4
1.14	23.7	99.6	0.4
1.15	23.1	99.5	0.5
1.16	22.6	99.5	0.5
1.17	22.1	99.4	0.6
1.18	21.7	99.3	0.7
1.19	21.2	99.2	0.8
1.20	20.8	99.2	0.8
1.21	20.4	99.1	0.9
1.22	20.1	99.0	1.0
1.23	19.7	98.9	1.1
1.24	19.4	98.9	1.1
1.25	19.1	98.8	1.2
1.26	18.8	98.7	1.3
1.27	18.5	98.6	1.4
1.28	18.2	98.5	1.5
1.29	17.9	98.4	1.6
1.30	17.7	98.3	1.7
1.32	17.2	98.1	1.9
1.34	16.8	97.9	2.1
1.36	16.3	97.7	2.3
1.38	15.9	97.5	2.5
1.40	15.6	97.2	2.8

VSWR	Return Loss dB	Power Transmitted %	Reflected Power %
1.42	15.2	97.0	3.0
1.44	14.9	96.7	3.3
1.46	14.6	96.5	3.5
1.48	14.3	96.3	3.7
1.50	14.0	96.0	4.0
1.52	13.7	95.7	4.3
1.54	13.4	95.5	4.5
1.56	13.2	95.2	4.8
1.58	13.0	94.9	5.1
1.60	12.7	94.7	5.3
1.62	12.5	94.4	5.6
1.64	12.3	94.1	5.9
1.66	12.1	93.8	6.2
1.68	11.9	93.6	6.4
1.70	11.7	93.3	6.7
1.72	11.5	93.0	7.0
1.74	11.4	92.7	7.3
1.76	11.2	92.4	7.6
1.78	11.0	92.1	7.9
1.80	10.9	91.8	8.2
1.82	10.7	91.5	8.5
1.84	10.6	91.3	8.7
1.86	10.4	91.0	9.0
1.88	10.3	90.7	9.3
1.90	10.3	90.4	9.6
1.92	10.0	90.1	9.9
1.94	9.9	89.8	10.2
1.96	9.8	89.5	10.5
1.98	9.7	89.2	10.8
2.00	9.5	88.9	11.1
2.50	7.4	81.6	18.4
3.00	6.0	75.0	25.0
4.00	4.4	64.0	36.0
5.00	3.5	55.6	44.4
10	1.7	33.1	66.9
20	0.9	18.9	81.9

Coaxial Cable Data

Type	Impedance Z_0	Outer Dia. (mm)	Attenuation (dB / 10 metres)		
			151MHz	433MHz	915MHz
RG - 8/U	52	10.3	0.89	1.68	2.73
RG - 9/U	51	10.67	0.89	1.68	2.73
RG - 58/U	53.5	4.95	1.89	3.41	5.30
RG - 58A/U	50	4.95	2.04	3.97	6.62
RG - 58C/U	50	4.95	2.04	3.97	6.62
RG-58 Cellfoam (9001)	50	4.9	1.86	3.16	4.59
RG-58 Cellfoil (9006)	50	5.1	1.40	2.37	3.44
RG - 174/U	50	2.56	3.43	6.10	9.32
RG - 213/U	50	10.29	0.89	1.68	2.73
RG - 214/U	50	10.8	0.89	1.68	2.73
RG - 223/U	50	5.38	1.79	3.24	5.05
RG - 303/U	50	4.31	1.28	2.45	4.00
RG - 316/U	50	2.49	3.60	6.31	9.51
BEL 9913	50	10.29	0.50	0.91	1.41

PRECAUTIONS TO TAKE WHEN INSTALLING AND TESTING ANTENNAS

- › Do not install antennas next to metal objects like downpipes.
- › Do not coil extra coaxial cable as a loop.
- › The ideal position of an antenna is as high as possible and away from any metal objects.
- › To test if the antenna is working you will need a SWR meter or Network Analyser. Do not use a volt meter as this will give incorrect results.
- › Always use 50 ohms coaxial cable like RG58. Do not use 75 ohms (RG59) or any other impedance with our antennas unless the antenna is specifically designed for that impedance. Using the wrong coaxial cable will reduce the communications range.
- › Use an SWR meter to measure the antenna SWR value in the installation position. This should be done before mounting. This allows you to easily change the position which can improve the SWR. SWR should be less than 1.5 : 1. Move the antenna away from metal objects.

Antenna – 151Mini

Miniature 151MHz antenna with SMA termination



DESCRIPTION

The 151Mini is a 19cm long antenna made for portable applications such as the hand-held FMT15108H transmitter. It can be used on any 151MHz equipment where a small antenna is required.

The termination on the 151Mini is a SMA connector.

Using Elsema SMA-15 allows you to change the termination to a PL259 connector. This allows you to connect the antenna to Elsema's high powered 151MHz transmitters, the FMT151 series.

FEATURES

- > Tuned to the 151MHz band
- > SMA termination
- > Short length at 19 cm
- > Uses strong molded flexible rubber

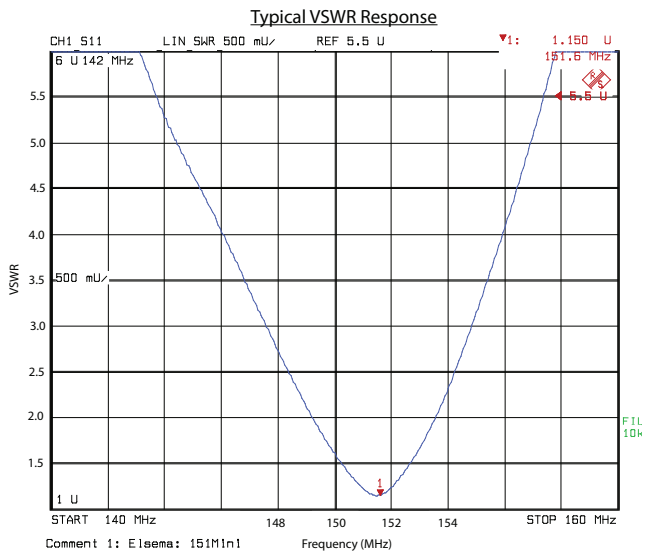

ELECTRICAL

Order Code (Model)	151Mini
Frequency	150.50 to 153.00MHz
Tuned Bandwidth	2.5MHz
Gain	0 dBi
VSWR (Return Loss)	< 1.5 : 1 over 2MHz
Impedance	50 Ohms
Maximum Power	5 Watt
Radiated Pattern	Omni Directional

MECHANICAL

Construction	Molded flexible rubber (Polyolefin)
Length	19 cm
Weight	12 grams
Coaxial Length	No Coaxial Cable
Termination	SMA, Standard PL259, with Optional SMA-15 adapter

Antenna – 151S

151MHz antenna with PL259 or SMA termination



SMA-20

DESCRIPTION

This antenna is only 21 cm long making it suitable for portable applications.

With its ruggedised construction and weatherproof casing the antenna is suitable for exterior use.

FEATURES

- › Tuned to the 151MHz band
- › PL259 termination
- › Strong molded flexible rubber

OPTIONS

An optional SMA-20 adapter is available to convert the PL259 termination to a SMA connector. This allows the antenna to be used on the FMT15104H, FMT15108H transmitters or any other products using a SMA connector.

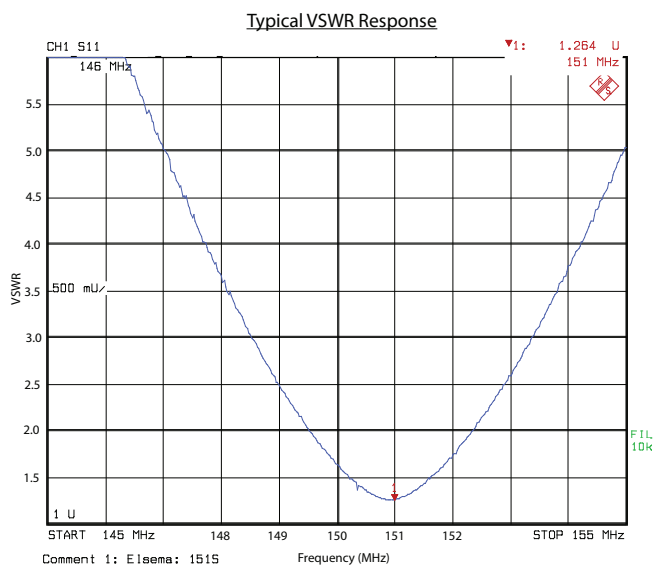

ELECTRICAL

Order Code (Model)	151S
Frequency	149.5 to 152.5MHz
Tuned Bandwidth	3MHz
Gain	1dBi
VSWR (Return Loss)	< 2.0 : 1 over 3MHz
Impedance	50 Ohms
Maximum Power	25 Watt
Radiated Pattern	Omni Directional

MECHANICAL

Construction	Molded flexible rubber (Polyolefin)
Length	21 cm
Weight	20 grams
Coaxial Length	No Coaxial Cable
Termination	PL259 or SMA with SMA-20 adapter

Antenna – ANT151S

151MHz antenna with coaxial cable, mounting bracket and PL259 connector

DESCRIPTION

This antenna is only 21 cm long making it suitable for portable applications.

With its ruggedised construction and weatherproof casing the antenna is suitable for exterior use.

The antenna comes standard with a universal mounting bracket for wall or roof installations and includes 1.5 metres of coaxial cable terminated with a PL259 plug.



FEATURES

- › Tuned to the 151MHz band
- › PL259 termination
- › Strong molded flexible rubber

OPTIONS

- › AB3.6PL, coaxial is 3.6 metres
- › AB5.0PL, coaxial is 5.0 metres
- › AB7.5PL, coaxial is 7.5 metres
- › AB10PL, coaxial is 10 metres
- › MBMirror, Mirror mount bracket for trucks and cars

Typical VSWR Response

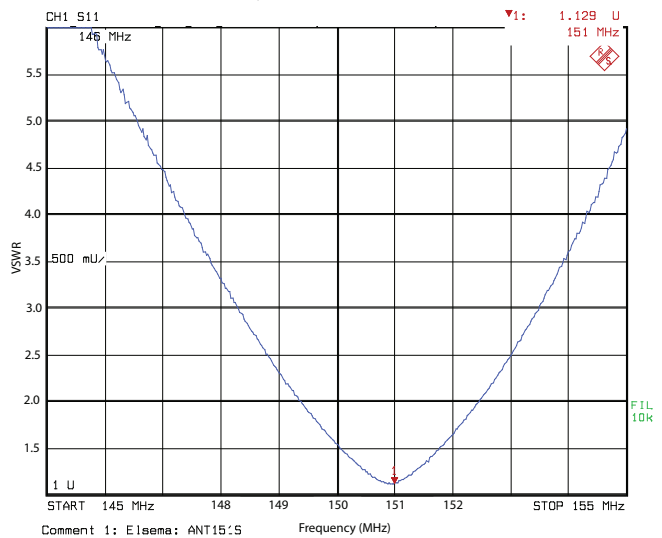

ELECTRICAL

Order Code (Model)	ANT151S
Frequency	149.5 to 152.5MHz
Tuned Bandwidth	3MHz
Gain	1dBi
VSWR (Return Loss)	< 2.0 : 1 over 3MHz
Impedance	50 Ohms
Maximum Power	25 Watt
Radiated Pattern	Omni Directional

MECHANICAL

Construction	Molded flexible rubber (Polyolefin)
Length	21 cm
Weight	170 grams
Coaxial Length	1.5 metres
Termination	PL259

Antenna – ANT151M

151MHz antenna with coaxial cable, mounting bracket and PL259 connector

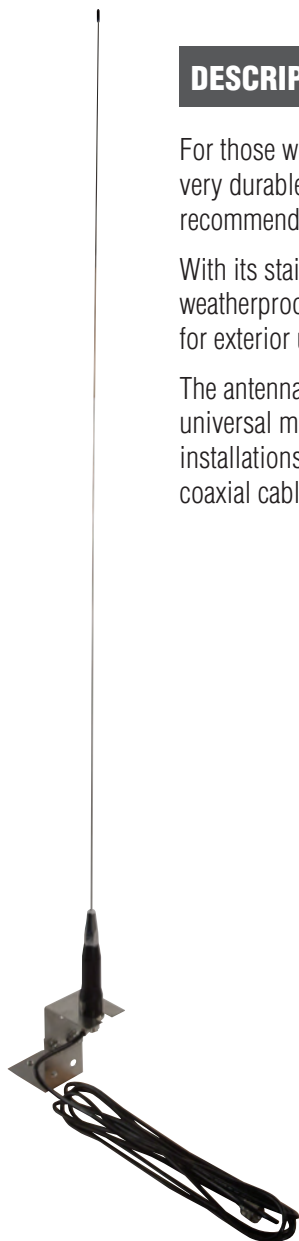

DESCRIPTION

For those who need a high gain and a very durable design the ANT151M is recommended.

With its stainless steel construction and weatherproof casing the antenna is suitable for exterior use.

The antenna comes standard with a universal mounting bracket for wall or roof installations and includes 3.6 metres of coaxial cable terminated with a PL259 plug.

FEATURES

- › Tuned to the 151MHz band
- › PL259 termination
- › High Gain at 3.5dBi
- › Durable stainless steel

OPTIONS

- › AB1.5PL, coaxial is 1.5 metres
- › AB5.0PL, coaxial is 5.0 metres
- › AB7.5PL, coaxial is 7.5 metres
- › AB10PL, coaxial is 10 metres
- › MBMirror, Mirror mount bracket for trucks and cars

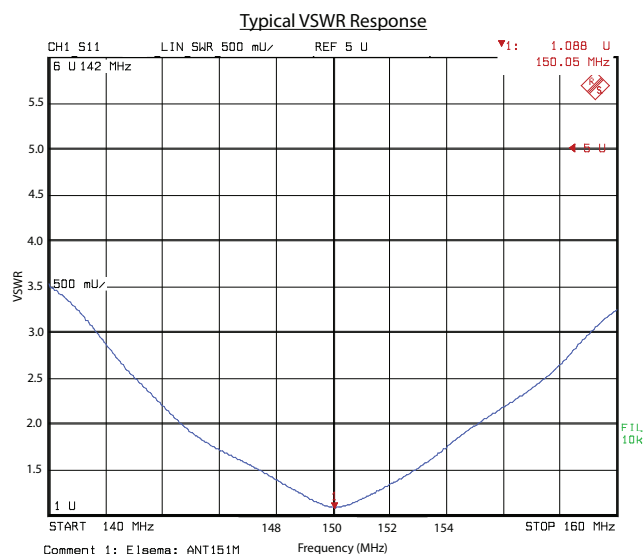

ELECTRICAL

Order Code (Model)	ANT151M
Frequency	148 to 153MHz
Tuned Bandwidth	5MHz
Gain	3.5dBi
VSWR (Return Loss)	< 1.5 : 1 over 5MHz
Impedance	50 Ohms
Maximum Power	25 Watt
Radiated Pattern	Omni Directional

MECHANICAL

Construction	Stainless Steel
Length	1.0 metre
Weight	500 grams
Coaxial Length	3.6 metres
Termination	PL259

Antenna – 433Micro

433MHz antenna with SMA connector



DESCRIPTION

The 433Micro is one of our smallest 433MHz antennas. With an overall length of only 45mm, it makes this antenna suitable for places with limited space.

Using a high quality SMA connector ensure that there are no losses with the connection

FEATURES

- › Tuned to the 433MHz band
- › SMA termination
- › Very short length at 45mm
- › Uses strong molded rubber

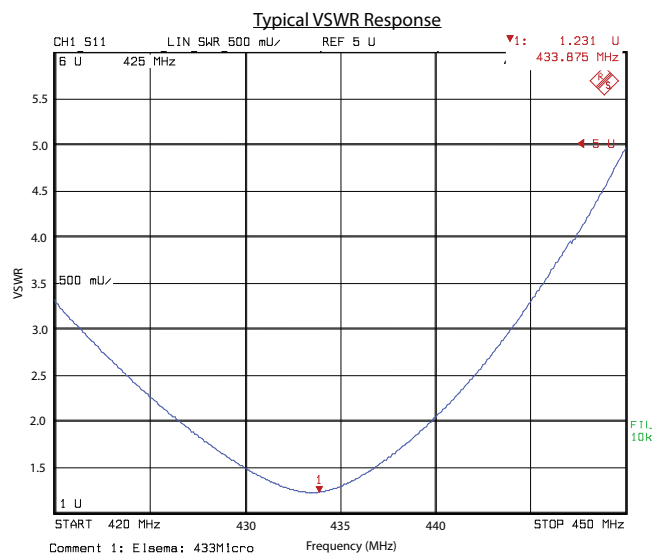

ELECTRICAL	
Order Code (Model)	433Micro
Frequency	433 to 435MHz
Tuned Bandwidth	2MHz
Gain	0 dBi
VSWR (Return Loss)	< 1.5 : 1 over 2MHz
Impedance	50 Ohms
Maximum Power	5 Watt
Radiated Pattern	Omni Directional

MECHANICAL	
Construction	Moulded rubber
Length	45 mm
Weight	8 grams
Coaxial Length	No Coaxial Cable
Termination	SMA

Antenna – 433Mini

Miniature 433MHz antenna with SMA connector



DESCRIPTION

The 433Mini is a 18 cm long antenna made for portable applications. It can be used on any 433MHz equipment where a small antenna is required.

The termination on the 433Mini is a high quality SMA connector.

FEATURES

- > Tuned to the 433MHz band
- > SMA termination
- > Short length at 18 cm
- > Uses strong molded flexible rubber

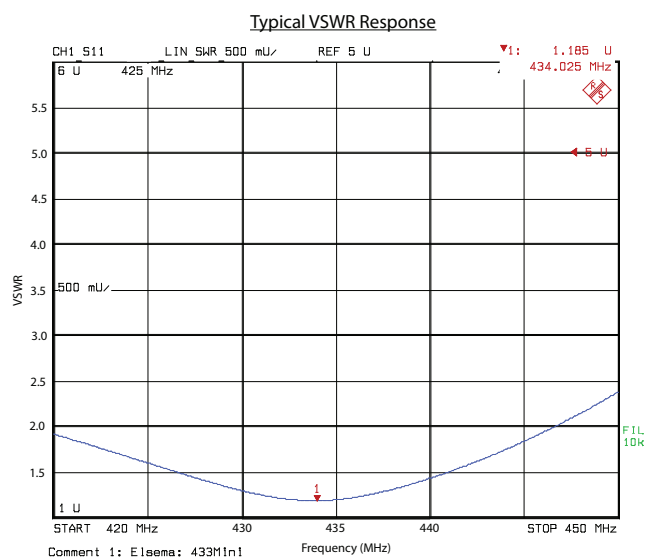

ELECTRICAL

Order Code (Model)	433Mini
Frequency	430 to 440MHz
Tuned Bandwidth	10MHz
Gain	1 dBi
VSWR (Return Loss)	< 1.5 : 1 over 10MHz
Impedance	50 Ohms
Maximum Power	5 Watt
Radiated Pattern	Omni Directional

MECHANICAL

Construction	Molded flexible rubber (Polyolefin)
Length	18 cm
Weight	12 grams
Coaxial Length	No Coaxial Cable
Termination	SMA, Standard

Antenna – ANT433LP

433MHz Low Profile antenna with coaxial cable, mounting bracket and SMA connector



DESCRIPTION

The ANT433LP is a Low Profile antenna with a length of 40mm and protected with a tamper proof casing.

The antenna comes standard with a universal mounting bracket for wall or roof installations and includes 3.6 metres of low loss coaxial cable terminated with a SMA connector.

FEATURES

- › Tuned to the 433MHz band
- › SMA termination
- › Short length at 40mm
- › High Impact Delrin Plastic
- › UV Stabilised

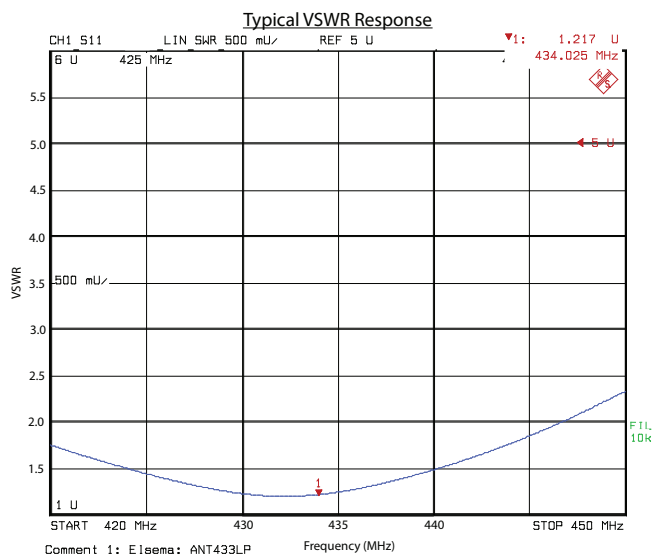

ELECTRICAL

Order Code (Model)	ANT433LP
Frequency	430 to 440MHz
Tuned Bandwidth	10MHz
Gain	2 dBi
VSWR (Return Loss)	< 1.5 : 1 over 10 MHz
Impedance	50 Ohms
Maximum Power	10 Watt
Radiated Pattern	Omni Directional

MECHANICAL

Construction	High Impact Delrin plastic UV stabilised
Length	40 mm
Weight	270 grams
Coaxial Length	3.6 metres
Termination	SMA, Standard

Antenna – ANT433S

433MHz antenna with coaxial cable, mounting bracket and SMA connector

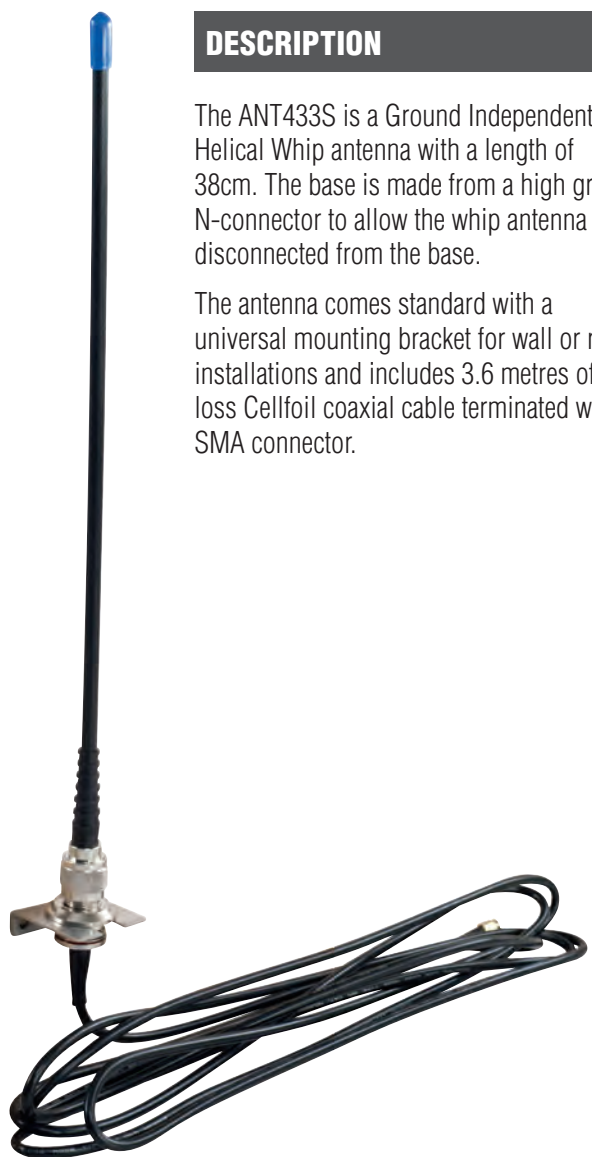

DESCRIPTION

The ANT433S is a Ground Independent Helical Whip antenna with a length of 38cm. The base is made from a high grade N-connector to allow the whip antenna to be disconnected from the base.

The antenna comes standard with a universal mounting bracket for wall or roof installations and includes 3.6 metres of low loss Cellfoil coaxial cable terminated with a SMA connector.

FEATURES

- › Easy to remove whip from the mounting base with an N-connector.
- › High gain at 4.5dBi
- › Tuned to the 433MHz band
- › Includes low loss cellfoil coaxial cable and mounting bracket
- › High quality SMA connector at the end of the coaxial cable

OPTIONS

- › AB1.5SMA, coaxial is 1.5 metres
- › AB5.0SMA, coaxial is 5.0 metres
- › AB7.5SMA, coaxial is 7.5 metres
- › AB10SMA, coaxial is 10 metres
- › MBMirror, Mirror mount bracket for trucks and cars

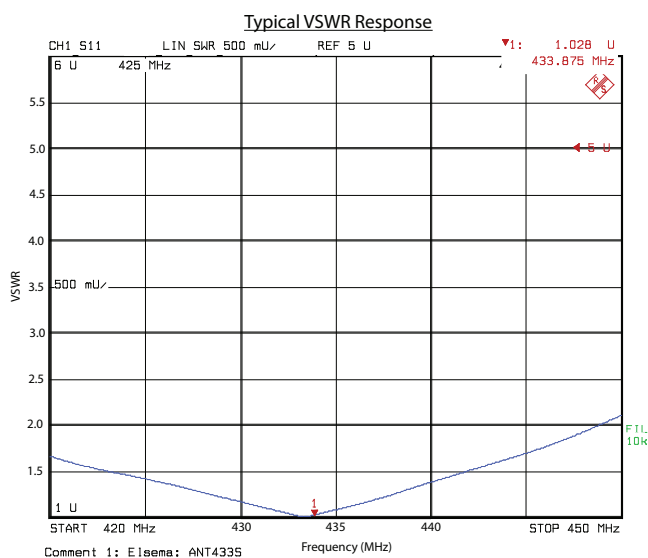

ELECTRICAL

Order Code (Model)	ANT433S
Frequency	425.00 to 442.50MHz
Tuned Bandwidth	17.50MHz
Gain	4.5 dBi
VSWR (Return Loss)	< 1.5 : 1 over 15MHz
Impedance	50 Ohms
Maximum Power	25 Watt
Radiated Pattern	Omni Directional

MECHANICAL

Construction	Molded flexible rubber (Polyolefin)
Length	38 cm
Weight	270 grams
Coaxial Length	3.6 metres, standard with N-connector base with part number AB3.6SMA
Termination	SMA, Standard

Antenna – ANT433M

High gain 433MHz antenna with coaxial cable, mounting bracket and SMA connector



DESCRIPTION

The ANT433M is a ground independent colinear antenna with a low angle of radiation. The term ground independent relates to its ability to be completely independent of the need for negative grounding (Earth). This feature allows the antenna to work efficiently in a wide variety of applications.

Its low VSWR and high gain makes this antenna suitable for applications that require extended range.

FEATURES

- › Stainless steel construction
- › High gain at 6.0 dBi
- › Tuned to the 433MHz band
- › Includes low loss cellfoil coaxial cable and mounting bracket
- › High quality SMA connector at the end of the coaxial cable

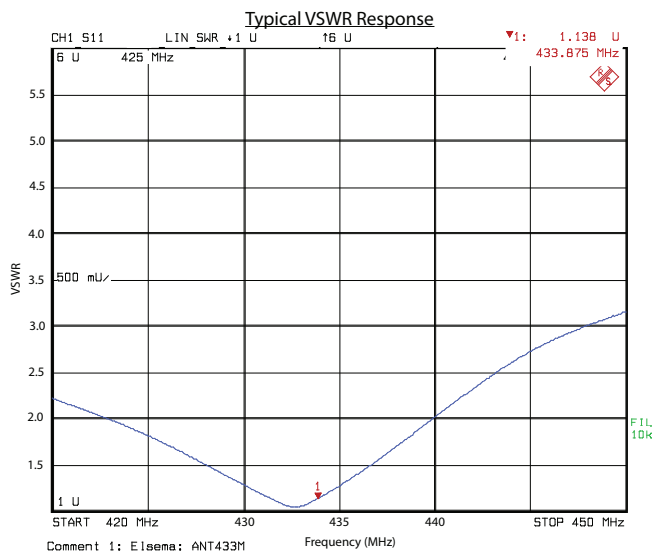

ELECTRICAL	
Order Code (Model)	ANT433M
Frequency	428 to 437MHz
Tuned Bandwidth	9MHz
Gain	6.0 dBi
VSWR (Return Loss)	< 1.5 : 1 over 9MHz
Impedance	50 Ohms
Maximum Power	50 Watt
Radiated Pattern	Low Angle Omni Directional

MECHANICAL	
Construction	Stainless Steel
Length	1 metre
Weight	420 grams
Coaxial Length	3.6 metres, standard
Termination	SMA, Standard

ANTENNAS

Antenna – 915Mini

915MHz antenna with SMA connector



DESCRIPTION

The 915Mini is a 20cm long antenna made for portable applications. It can be used on any equipment in the 900MHz band where an omni-directional radiation pattern of 360 degree coverage is required.

The termination on the 915Mini is a high quality SMA connector with a swivel base.

FEATURES

- > Tuned to the 915MHz band
- > High quality SMA connector
- > Short length at 20 cm
- > Uses strong molded flexible rubber

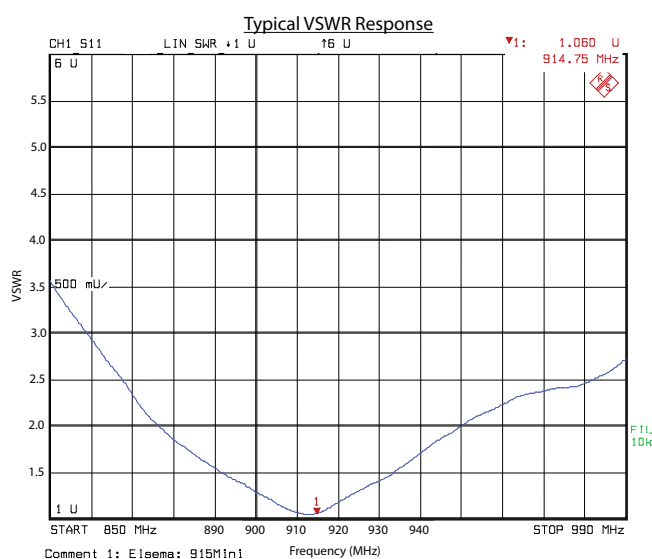

ELECTRICAL

Order Code (Model)	915Mini
Frequency	895 to 930MHz
Tuned Bandwidth	35MHz
Gain	3.0 dBi
VSWR (Return Loss)	< 1.5 : 1 over 35MHz
Impedance	50 Ohms
Maximum Power	15 Watt
Radiated Pattern	Omni Directional

MECHANICAL

Construction	Molded flexible rubber (Polyolefin)
Length	20 cm
Weight	30 grams
Coaxial Length	No Coaxial Cable
Termination	SMA, Standard

Antenna – 915S-N

915MHz antenna with N-type connector



DESCRIPTION

The 915S-N is a Ground Independent Helical Whip antenna with a length of 18cm. The base is made from a high grade N-connector to allow the whip antenna to be connected to the commonly used N-type connector base.

Elsema has developed a weatherproof N-type connector base which is available in different coaxial cable lengths.

- > AB1.5SMA, N-type base with 1.5 metres cable
- > AB3.6SMA, N-type base with 3.6 metres cable
- > AB5.0SMA, N-type base with 5.0 metres cable

Custom coaxial cables lengths can be made upon request. Call Elsema.

FEATURES

- > Tuned to the 915MHz band
- > High quality N-connector
- > Short length at 18 cm
- > Uses strong molded flexible rubber
- > Omni-directional radiation pattern of 360 degrees

OPTIONS

- > AB1.5SMA, coaxial is 1.5 metres
- > AB3.6SMA, coaxial is 3.6 metres
- > AB5.0SMA, coaxial is 5.0 metres
- > AB7.5SMA, coaxial is 7.5 metres
- > AB10SMA, coaxial is 10 metres
- > MBMirror, Mirror mount bracket for trucks and cars

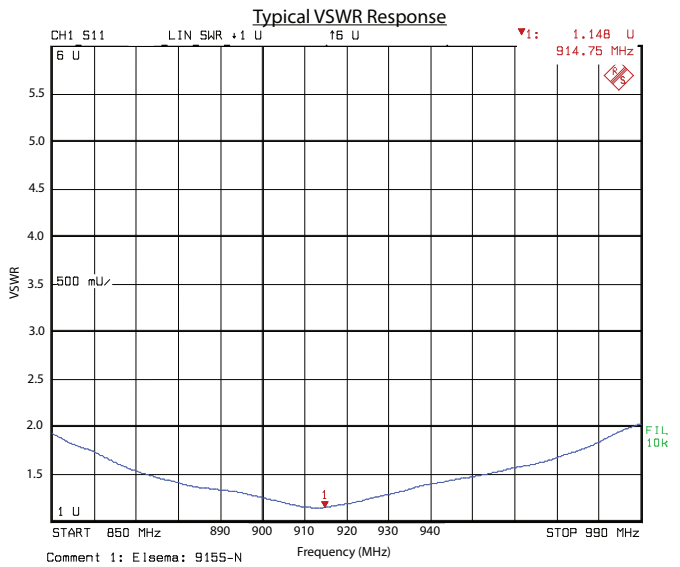

ELECTRICAL

Order Code (Model)	915S-N
Frequency	875 to 950MHz
Tuned Bandwidth	75MHz
Gain	4.0 dBi
VSWR (Return Loss)	< 1.5 : 1 over 75MHz
Impedance	50 Ohms
Maximum Power	25 Watt
Radiated Pattern	Omni Directional

MECHANICAL

Construction	Molded flexible rubber (Polyolefin)
Length	18 cm
Weight	38 grams
Coaxial Length	No Coaxial Cable
Termination	N-Type connector

ANTENNAS

Antenna – ANT900LP

860 – 960MHz antenna with coaxial cable, mounting bracket and SMA connector

DESCRIPTION

The ANT900LP is a Low Profile antenna with a length of 40mm and protected with a tamper-proof casing.

The antenna comes standard with a universal mounting bracket for wall or roof installations and includes 3.6 metres of low loss coaxial cable terminated with a SMA connector.



FEATURES

- › Tuned to 860 - 960 MHz band
- › SMA termination
- › High Impact Delrin plastic
- › Suitable for outdoor installation

Typical VSWR Response

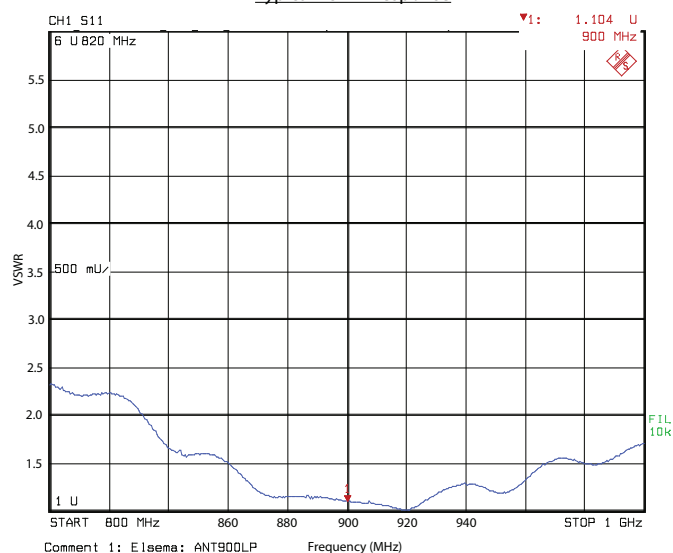

ELECTRICAL

Order Code (Model)	ANT900LP
Frequency	860 to 960MHz
Tuned Bandwidth	100MHz
Gain	2dBi
VSWR (Return Loss)	< 1.5 : 1 over 100MHz
Impedance	50 Ohms
Maximum Power	25 Watt
Radiated Pattern	Omni Directional

MECHANICAL

Construction	High Impact Delrin plastic UV stabilised
Length	40 mm
Weight	260 grams
Coaxial Length	3.6 metres
Termination	SMA, Other Options Available

Antenna – ANT915S

915MHz antenna with coaxial cable, mounting bracket and SMA connector

DESCRIPTION

The ANT915S antenna represents the “State of the Art” in Ground Independent Antenna technology, providing a low angle of radiation with a minimum of 4dBi gain.

The base is made from a high grade N-connector to allow the whip antenna to be disconnected from the base.

The antenna comes standard with a universal mounting bracket for wall or roof installations and includes 3.6 metres of low loss Cellfoil coaxial cable terminated with a SMA connector.

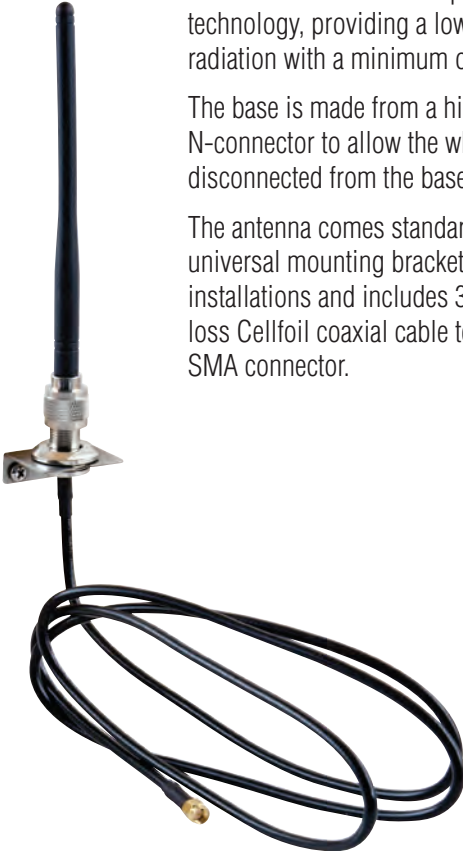

FEATURES

- › Tuned to the 915MHz band
- › Includes Low Loss Cellfoil Coaxial Cable and mounting bracket
- › High quality SMA connector
- › N-type connector base for very low loss and weatherproof

OPTIONS

- › AB1.5SMA, coaxial is 1.5 metres
- › AB5.0SMA, coaxial is 5.0 metres
- › AB7.5SMA, coaxial is 7.5 metres
- › AB10SMA, coaxial is 10 metres
- › MBMirror, Mirror mount bracket for trucks and cars

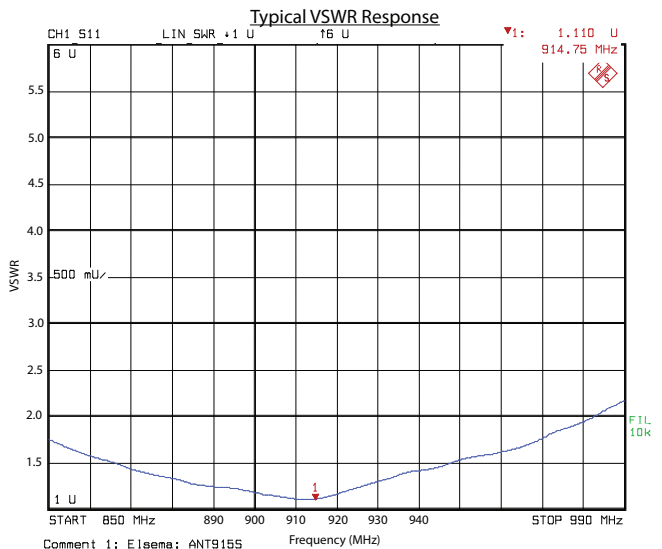

ELECTRICAL

Order Code (Model)	ANT915S
Frequency	870 to 940MHz
Tuned Bandwidth	70MHz
Gain	4.0 dBi
VSWR (Return Loss)	< 1.5 : 1 over 70MHz
Impedance	50 Ohms
Maximum Power	25 Watt
Radiated Pattern	Omni Directional

MECHANICAL

Construction	Molded flexible rubber (Polyolefin)
Length	19 cm
Weight	210 grams
Coaxial Length	3.6 metres
Termination	SMA, Standard

Antenna – ANT915M

High gain 915MHz antenna with coaxial cable, mounting bracket and SMA connector

DESCRIPTION

The ANT915M is a 65cm long ground independent colinear antenna with an omni directional radiation pattern. The term ground independent relates to its ability to be completely independent of the need for negative grounding (Earth). This feature allows the antenna to work efficiently in a wide variety of applications.

Its low VSWR and high gain makes this antenna suitable for applications that require extended range.

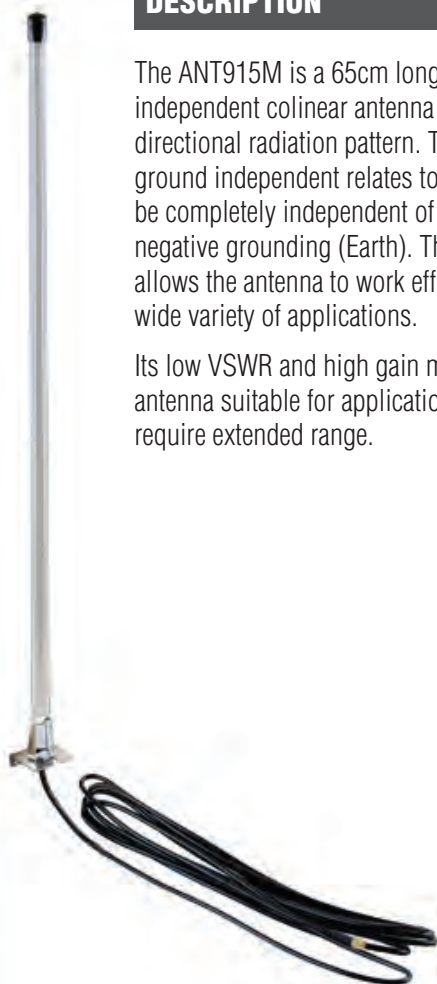

FEATURES

- › High gain at 6.5 dBi
- › Tuned to the 915MHz band
- › Includes low loss cellfoil coaxial cable and mounting bracket
- › High quality SMA connector at the end of the coaxial cable

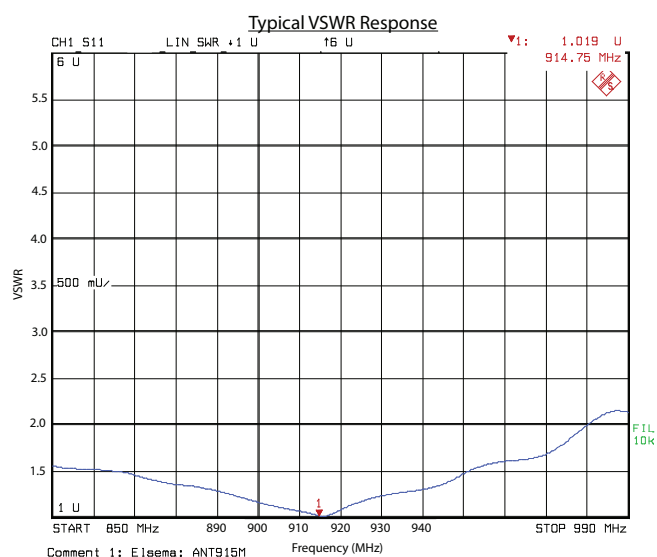

ELECTRICAL

Order Code (Model)	ANT915M
Frequency	870 to 950MHz
Tuned Bandwidth	80MHz
Gain	6.5 dBi
VSWR (Return Loss)	< 1.5 : 1 over 80MHz
Impedance	50 Ohms
Maximum Power	100 Watt
Radiated Pattern	Omni Directional

MECHANICAL

Construction	Brass elements and Black Fibreglass Radome
Length	0.65 metre
Weight	390 grams
Coaxial Length	3.6 metres, standard
Termination	SMA, Standard

Antenna Accessories and Options



Low Loss Cellfoil RG58



AB1.5PL, Coaxial is 1.5m
 AB3.6PL, Coaxial is 3.6m
 AB5.0PL, Coaxial is 5.0m
 AB7.5PL, Coaxial is 7.5m
 AB10PL, Coaxial is 10m



AB1.5SMA, Coaxial is 1.5m
 AB3.6SMA, Coaxial is 3.6m
 AB5.0SMA, Coaxial is 5.0m
 AB7.5SMA, Coaxial is 7.5m
 AB10SMA, Coaxial is 10m

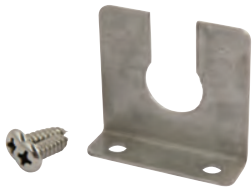

Small Mounting Bracket
 MBSmall



Large Mounting Bracket
 MBLarge



Mirror Mounting Bracket for
 trucks, 4WD and cars
 MBMirror



PL259 Connector
 PL259



SO239 Flange Mount
 SO239



SO239 Double Jack
 SO239Jack



SMA Flange Mount
 SMA-1



SMA 90 degree jack
 SMA-2



SMA jack straight PCB mount
 SMA-3



SMA Female to PL259 adapter
 SMA-15



SMA Male to SO239 adapter
 SMA-20

Batteries



6 Volt 4LR44



9 Volt Carbon Battery



9 Volt Alkaline Battery



12 Volt Alkaline Battery



3 Volt Lithium Battery



12 Volt 1.2Ah Rechargeable
LAB12-1.2



12 Volt 2.3Ah Rechargeable
LAB12-2.3



12 Volt 7.0Ah Rechargeable
LAB12-7.0



12 Volt 15Ah Deep Cycle
LAB12-15D

BATTERIES

Battery Chargers

Battery chargers for solar applications or for AC backup systems

DESCRIPTION

Elsema battery chargers are designed to quickly and effectively charge batteries to its full capacity. They can be used for standalone solar applications or for backup systems with AC supply. The BACH12-1200 and the BACH24-1200 chargers batteries with 1.2 Amps max current while the MPPT -Lead is designed for 12 or 24 Volt solar applications.

1.2 AMPS CHARGER WITH LED INDICATION

PART NO	BACH12-1200	BACH24-1200
Supply Voltage	12 Volts	24 Volts
Charging Current	1.2 Amps	1.2 Amps

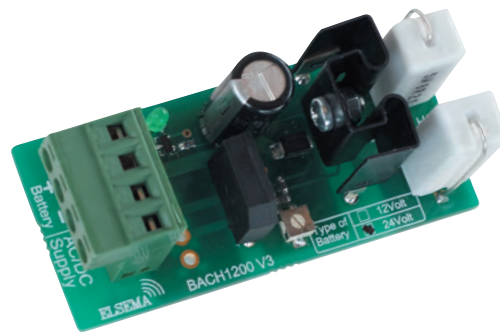

10.0 AMPS SOLAR CHARGER WITH MPPT AND BLUETOOTH

PART NO	MPPT-12LEAD OR MPPT-24LEAD
Supply Voltage	12 or 24 Volts Solar Panel*
Charging Current	10.0 Amps

* Charger is configured at the factory for 12V or 24V. Please order the correct voltage



BATTERY CHARGER WITH REGULATED SUPPLY

PART NO	SUPREG12	SUPREG24
Supply Voltage	12 Volts	24 Volts
Charging Current	0.8 Amps	0.8 Amps
Regulated Output	5 Amps (8 Amps Peak)	5 Amps (8 Amps Peak)



BATTERY CHARGERS

Flashing Lights

Flashing lights for warning or to indicate danger

DESCRIPTION

Flashing lights (also known as warning lights or strobe lights) can be used in a variety of applications such as warning lights to indicate danger. Elsema has different color lights to suite your application. It can be used on trucks, carts, forklifts, automatic gates & doors or any other application which requires a visual indication of any danger or warning.

E80 SERIES



E80L SERIES 90° Wall Mount Type



PART NO	E80-A	E80-R	E80-B	E80-G
Colour	Amber	Red	Blue	Green
Supply Voltage	12-24VDC	12-24VDC	12-24VDC	12-24VDC

E80L-A	E80L-R	E80L-B	E80L-G
Amber	Red	Blue	Green
12-24VDC	12-24VDC	12-24VDC	12-24VDC

ST SERIES



PART NO	ST12A	ST12R	ST12B
Colour	Amber	Red	Blue
Supply Voltage	12 Volts DC	12 Volts DC	12 Volts DC

ST24A	ST24R	ST24B
Amber	Red	Blue
24 Volts DC	24 Volts DC	24 Volts DC

1, 8, 12 and 16 Channel Aux Relay Cards

DESCRIPTION

When you have to switch large loads with open collector outputs or small relays then the auxiliary relay modules can be used. The relay module will isolate and protect your electronic circuits.

The relay modules use an industrial grade relay which conforms to several safety standards, UL, C-UL and VDE.

FEATURES

- › Relay rated up to 16 Amps 240 VAC
- › Normally open and normally closed contacts
- › Relay coil protected for spike-free operation
- › On-board LED to indicate relay “on”
- › Available with plug-in terminal blocks for easy installation
- › Optional QM100 or QM150 bracket to mount up to 4 relay modules together

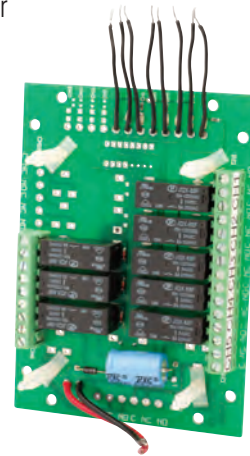
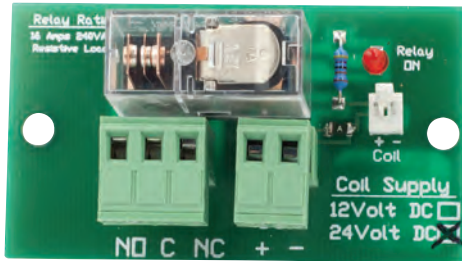

PART NO	RELAY1-12	RELAY1-24
Contact Rating	16 Amps 250VAC	16 Amps 250VAC
Supply Voltage	11 – 14VDC	21 – 28 VDC

PART NO	RELAY8-12	RELAY8-24
Contact Rating	10 Amps 240VAC	10 Amps 240VAC
Supply Voltage	11 – 14VDC	21 – 28 VDC



PART NO	RELAY12-12	RELAY12-24
Contact Rating	10 Amps 250VAC	10 Amps 250VAC
Supply Voltage	11 – 14VDC	21 – 28 VDC

PART NO	RELAY16-12	RELAY16-24
Contact Rating	10 Amps 240VAC	10 Amps 240VAC
Supply Voltage	11 – 14VDC	21 – 28 VDC

RelayH1-12, RelayH1-24, RelayH2-12 and RelayH2-24

Aux Relay Card to Switch Currents up to 35 Amps

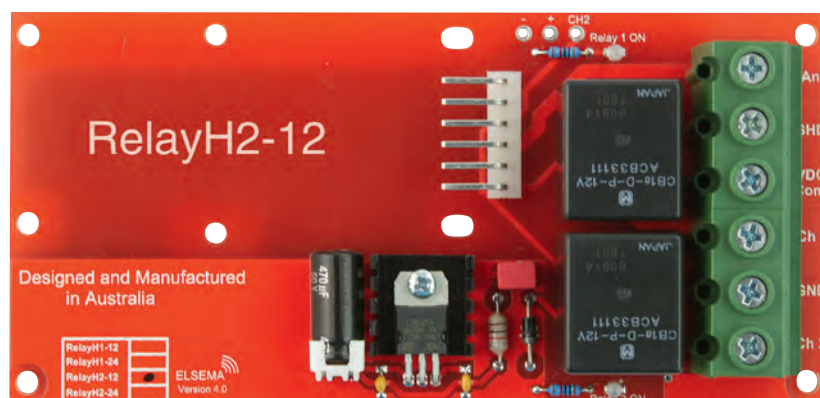

FEATURES

- › Massive switching current of up to 35 Amps for each relay
- › Compatible with Elsema plug-in receivers
- › Available as single or dual relays with 12 or 24 volts DC supply connection
- › Built-in pre-regulator and filter to protect and isolated receiver electronics from the power currents and voltages
- › Built-in LED's to indicate when relays are activated.
- › Industrial grade printed circuit board material to handle the high currents, temperature and vibration.
- › Built-in back EMF diodes to reduce noise

DESCRIPTION

With each component created exactly according to its purpose the H1 and H2 aux relay cards gives you a massive 35 Amps switching current. The high-quality components provide extreme durability, improved longevity and enhanced thermal performance.











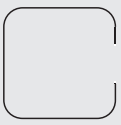

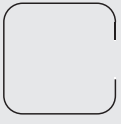
Each card uses automotive grade relays and is individually tested to deliver the maximum current continuously. The aux relay card uses the standard 6-pin connector that is compatible with the 915MHz, 433MHz and Penta series Elsema plug-in receivers. Each receiver is plug and play compatible and the card provides pre-drilled holes to securely mount the receiver for extreme vibrating applications.

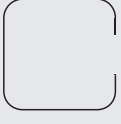
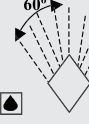
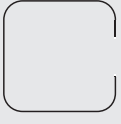
TECHNICAL DATA

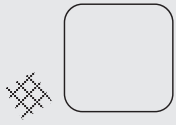
Power Supply	12 or 24 Volts DC
Switch Current	35 Amps
Output	Common (C) and Normally Open (NO) contact. Common is internally wired to supply positive.
Compatible Receivers	MCR91501P, MCR91502P, GLR43301SS, GLR43302SS and GLR2702SS
Dimensions	155 x 75 x 35mm

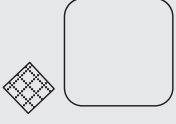
International Protection (IP) Ratings

IP54 = IP Letter Code _____ IP
 1st Digit _____ 5
 2nd Digit _____ 4

1 st Digit	Protection from solid objects	2 nd Digit	Protection from moisture
0	NON-PROTECTED	0	NON-PROTECTED
1	 Protected against solid objects greater than 50mm	1	 Protected against dripping water
2	 Protected against solid objects greater than 12mm	2	 Protected against dripping water when tilted up to 15°
3	 Protected against solid objects greater than 2.5mm Ø	3	 Protected against spraying water
4	 Protected against solid objects greater than 1.0mm Ø	4	 Protected against splashing water
5	 Dust protected	5	 Protected against water jets
6	 Dust tight	6	 Protected against heavy seas
		7	 Protected against the effects of immersion between 15cm and 1m
		8	 Protected against long periods of immersion under pressure

Plastic Cases

DESCRIPTION

Cases are all to EN60529 standard with Ingress Protection of IP66. Suitable for temperature range -40 to +80 degrees.



C0611 – Size 65 x 115 x 40 mm



C0818 – Size 80 x 180 x 70 mm



C1015 – Size 100 x 150 x 70 mm



C1015T – Size 100 x 150 x 70 mm
Metal Latch and Transparent Cover



C1020 – Size 100 x 200 x 70 mm



C1020T – Size 100 x 200 x 70 mm
Plastic Latch and Transparent Cover



C1217 – Size 125 x 175 x 75 mm



C1515 – Size 150 x 150 x 90 mm



C1515T – Size 150 x 150 x 90 mm
Plastic Latch and Transparent Cover



C1520 – Size 150 x 200 x 100 mm



C1717 – Size 175 x 175 x 75 mm

Plastic Cases



C1722 – Size 170 x 220 x 110 mm



C1722T – Size 170 x 220 x 110 mm
Plastic Latch and Transparent Cover



C1725 – Size 175 x 250 x 75 mm



C1725-1 – Size 175 x 250 x 100 mm



C1929 – Size 190 x 290 x 140 mm



C1929T – Size 190 x 290 x 140 mm
Plastic Latch and Transparent Cover

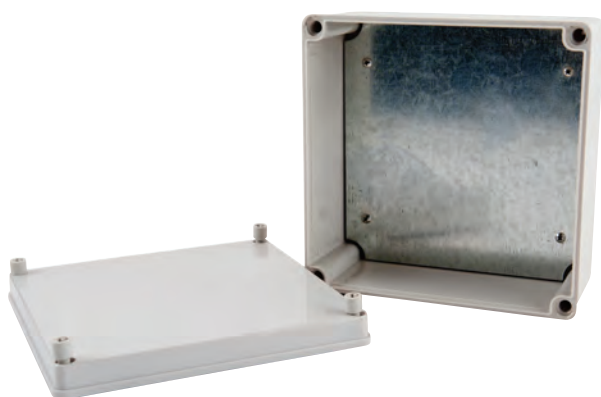

C2020-S – Size 200 x 200 x 75 mm



C2828 – Size 280 x 280 x 130 mm



C3428 – Size 340 x 280 x 130 mm



C3428T – Size 340 x 280 x 130 mm
Transparent Cover

ELSEMA

WIRELESS COMMUNICATIONS

UNITED STATES OF AMERICA

Remote Control Technology, Inc.

13649 NE 126th PL. #201

Kirkland, WA 98034

USA

Phone: 1-866-701-1146

Fax: 1-425-216-7558

Email: industrialsales@remotecontroltech.com

Web: www.remotecontroltech.com

Bucking Bull Pro

339409 East 830 Rd

Carney, Ok 74832

USA

Phone: 1-405-269-1959

Email: buckingbullpro@aol.com

NEW ZEALAND

Arrowhead Alarm Ltd

344B Rosedale Road

Albany, Auckland

New Zealand

Phone: +64 9414-0085

Web: www.aap.co.nz

NETHERLANDS

HS-PAS

Ambachtstraat 14 - 4261 TJ Wijk en Aalburg

Netherlands

Phone: +31 (0)416-820300

Fax: +31 (0)416-820301

Email: info@hs-pas.nl

Web: www.hs-pas.nl

LOCAL DISTRIBUTOR

ELSEMA PTY LTD

31 Tarlington Place
Smithfield NSW 2164 Australia

P +61 2 9609 4668

W www.elsema.com