

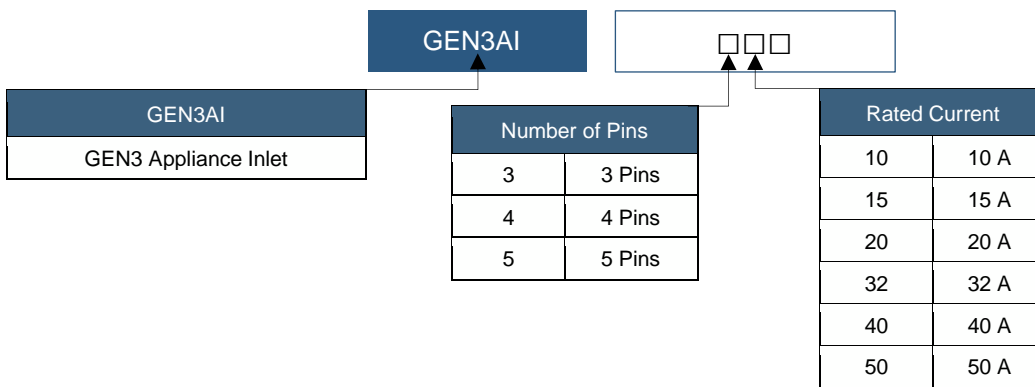

**GEN3 Appliance Inlets**

- Used for generator Connections on the side of Switchboards or where a secondary power supply connection is required.
- Combination from 10 to 50A
- Available in 3, 4 and 5 Pin
- IP Rating; IP66
- Made from PCA 18 virgin grade plastics
- All internal connections have greater than 80% Copper content, which helps with the heat rise.
- Compatible with other major brands
- Standards; Conforming to AS/NZS 3123:2005



**Properties**

Properties	
Manufacturer	GEN3
Product Range	GEN3 Appliance Inlets
IP Rating	IP66
Rated Current	10 - 50 A
Rated Voltage	250 V (1 Phase), 500 V (3 Phase)
Standards	AS/NZS 3123:2005

**Dimensions for GEN3AI3□□**

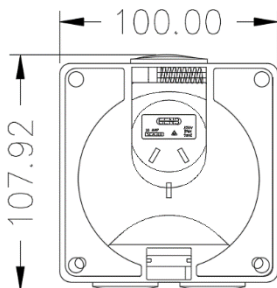

FRONT VIEW

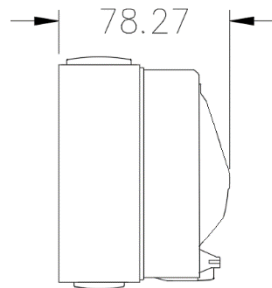

SIDE VIEW

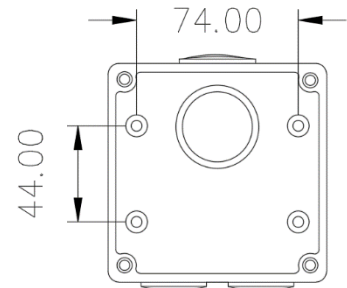

MOUNTING HOLE DETAIL

Dimensions for GEN3AI4□□ and GEN3AI5□□

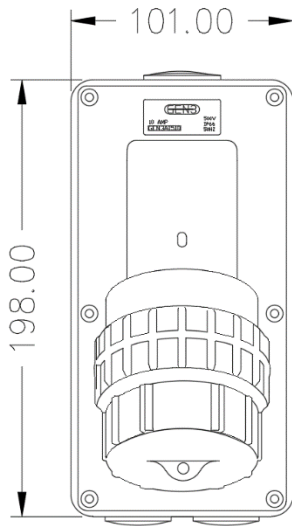

FRONT VIEW

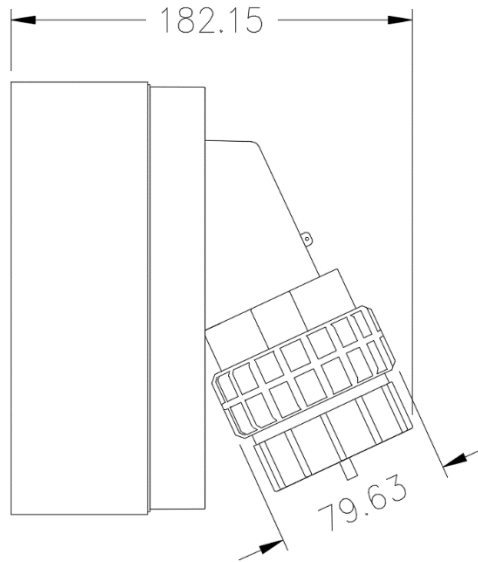

SIDE VIEW

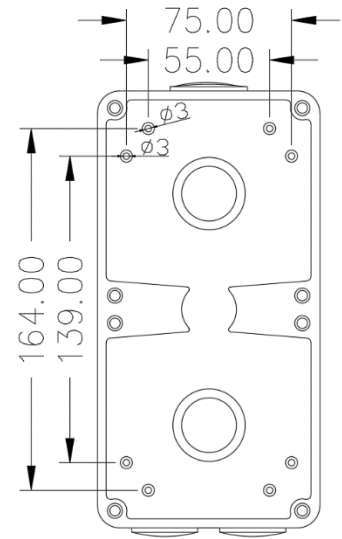

MOUNTING HOLE DETAIL