

Catalogue number: **FKL66**□□-□□□

Eureka IP54 Complete Fan Units and Vent Kits



Complete Vent Kits



Complete Fan Kits

Complete Fan Units and Vent Kits

- Colour; RAL7035
- Degree of protection: IP54
- Highly Efficient dust-proof and Durable Design
- Filter Mat aids in reducing dust and particles
- Premium and durable materials
- Vents are made of Injection-moulded Thermoplastic
- Standard certifications: CE RoHS UL

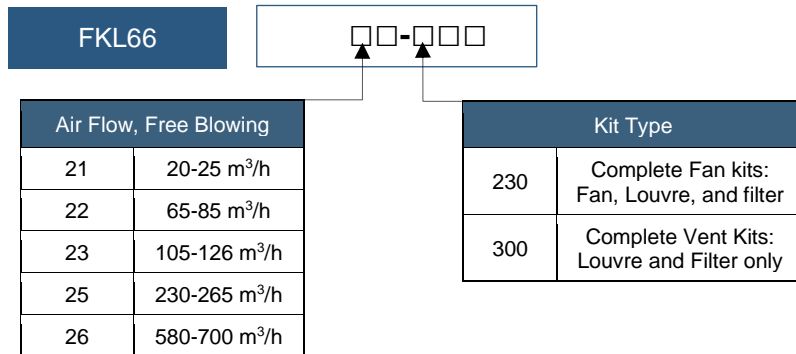

Properties

Properties	FKL6621	FKL6622	FKL6623	FKL6625	FKL6626
Manufacturer	Linkwell Electric				
Product Range	Eureka Complete Fan Kits- FKL66□□-230 Eureka Complete Vent Kits- FKL66□□-300				
Degree of Protection	IP54				
Colour	RAL 7035				
Rated Voltage	240VAC				
Frequency	50/60Hz				
Rated Current	0.08 A	0.10 - 0.12 A	0.10 - 0.12 A	0.20 - 0.25 A	0.30 - 0.34 A
Rated Power	14-18 W	14 - 19 W	14 - 19 W	33 - 37 W	65 - 75 W
Operating Temperature	-30 - +70 °C				
Noise Level	37 - 41 dB(A)	36 - 40 dB(A)	36 - 40 dB(A)	46 - 50 dB(A)	55 - 57 dB(A)
Air Flow, Free Blowing	25 - 35 m <sup>3</sup> /h	65 - 85 m <sup>3</sup> /h	105 - 126 m <sup>3</sup> /h	230 - 265 m <sup>3</sup> /h	580 - 700 m <sup>3</sup> /h
Air flow with Exit Filter	20 - 25 m <sup>3</sup> /h	55 - 70 m <sup>3</sup> /h	71 - 82 m <sup>3</sup> /h	170 - 205 m <sup>3</sup> /h	380 - 410 m <sup>3</sup> /h
Inflammability rate	UL94 V-0				
Specification	CE RoHS UL				



### Dimensions for FLK6621

FLK6621-230

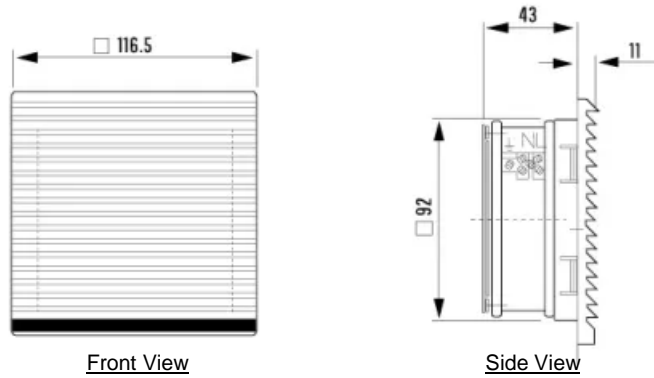

FLK6621-300

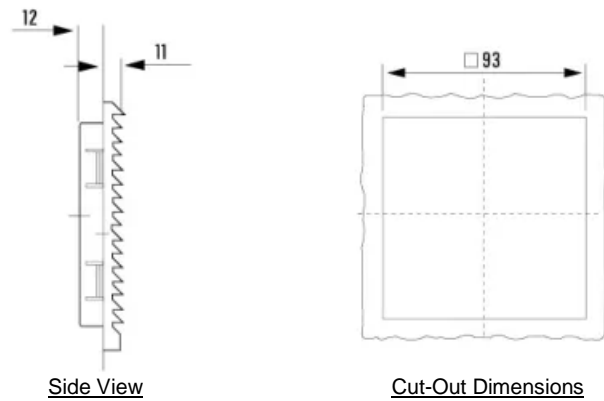

### Dimensions for FLK6622

FLK6622-230

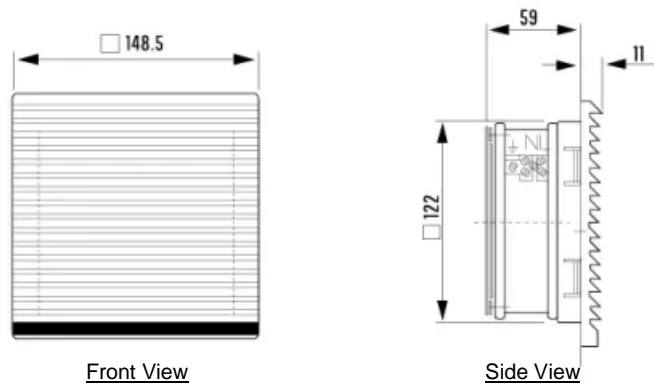

FLK6622-300

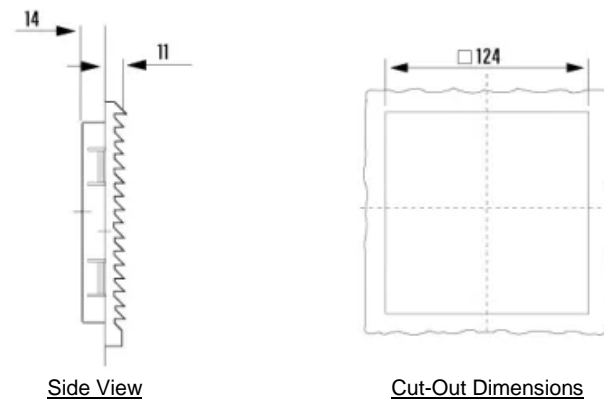

### Dimensions for FLK6623

FLK6623-230

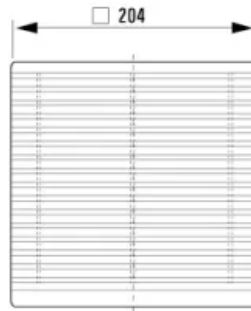

Front View

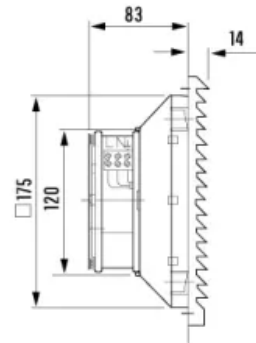

Side View

FLK6623-300

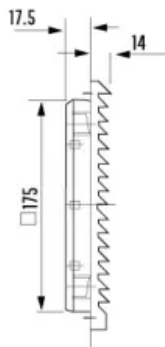

Side View

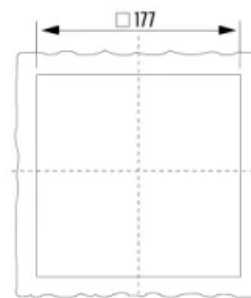

Cut-Out Dimensions

### Dimensions for FLK6625

FLK6625-230

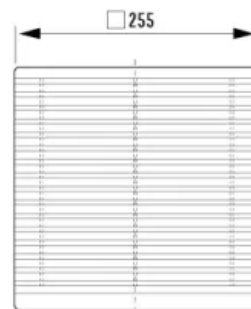

Front View

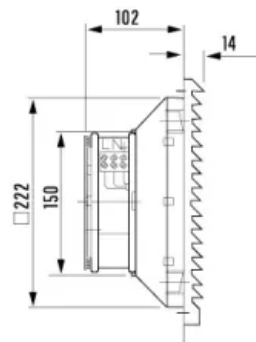

Side View

FLK6625-300

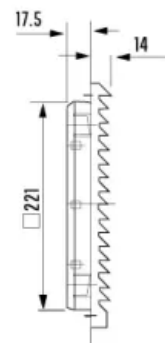

Side View

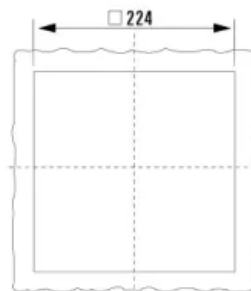

Cut-Out Dimensions

Catalogue number: **FKL66**□□-□□□

Eureka IP54 Complete Fan Units and Complete Vent Kits

**eureka**\*



Dimensions for FLK6626

FLK6626-230



Front View

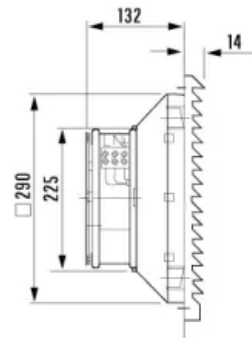

Side View

FLK6626-300

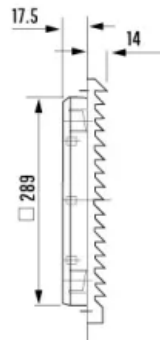

Side View

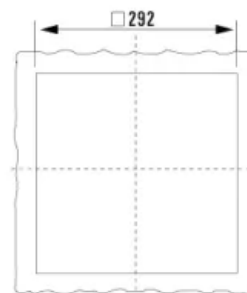

Cut-Out Dimensions

