

Catalogue number: **ELS6-**□□/□□□□□□

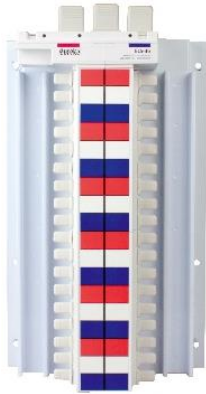

400A 3 Phase Flat Pan Chassis 18/27mm Pitch



400A 3 Phase Flat Pan Chassis

- Current Rating: 400A
- Encapsulated Busbar
- Current withstand Rating 400A: 30kA 0.1s
- Available in 18 or 27 mm pitch or Hybrid Chassis (18 & 27 mm)
- Options to fit LS 400A DSU or NETS Breakers as Main Switch
- Split Chassis achieved by using DB-CB-EUR-SP Bracket
- Standards: AS/NZS 3439.1, AS 60529, IEC 61439.1 & 61439.2

ELS6- □□/□□□□□□

Number of Poles	
12	12 Pole
18	18 Pole
24	24 Pole
30	30 Pole
36	36 Pole
42	42 Pole
48	48 Pole
60	60 Pole
72	72 Pole
84	84 Pole
96	96 Pole

Chassis type	
182	Flat Pan Chassis 18mm Pitch
272	Flat Pan Chassis 27mm Pitch
18272	Flat Pan Hybrid Chassis 18/27mm Pitch

Properties

Properties	
Manufacturer	Eureka
Product Range	Eureka 400A Flat Pan Chassis
Chassis Type	Encapsulated 400A Main Chassis
Compatible Product Series	MCB's : LSBE, LSBS and BKH RCBO's : LSSO and LSTO
Busbar Thickness	3.0mm Cu
Pitch	18mm/27mm
Rated Current	In 400A
Rated Operating Voltage	Un 415V
Rated Insulation Voltage	Ui 440V
Rated Frequency	50/60HZ
Rated Short-time withstand Current	Icw 0.1s 30kA
Rated Peak withstand Current	Ipk 63kA
Rated Diversity Factor	0.8
Standard Compliance	AS/NZS 3439.1:2002 AS 60529:2004 IEC 61439.1 and 61439.2



Dimensions for ELS6-□□/182

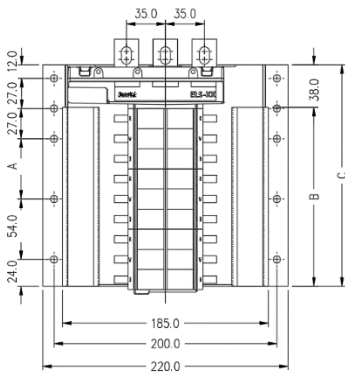

CHASSIS FRONT ELEVATION

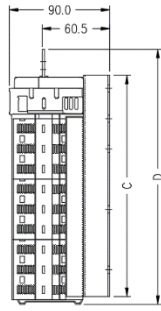

CHASSIS SIDE VIEW

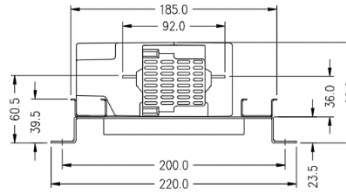

CHASSIS BOTTOM VIEW

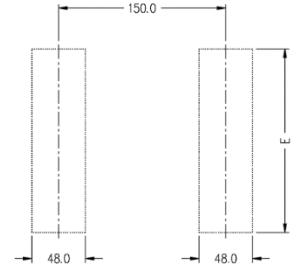

ESCUTCHEON CUTOUTS

Part No.	A	B	C	D	E	Number of Poles
						18mm
ELS6-12/182	0	106	144	174	110	12
ELS6-18/182	54	160	198	228	164	18
ELS6-24/182	108	214	252	282	218	24
ELS6-30/182	162	268	306	336	272	30
ELS6-36/182	216	322	360	390	326	36
ELS6-42/182	270	376	414	444	380	42
ELS6-48/182	324	430	468	498	434	48
ELS6-60/182	432	538	576	606	542	60
ELS6-72/182	540	646	684	714	650	72
ELS6-84/182	648	754	792	822	758	84
ELS6-96/182	756	862	900	930	866	96

Dimensions for ELS6-□□/272

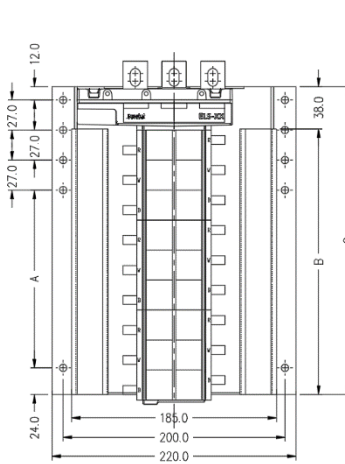

CHASSIS FRONT ELEVATION

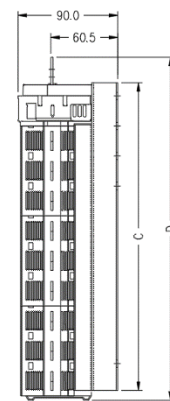

CHASSIS SIDE VIEW

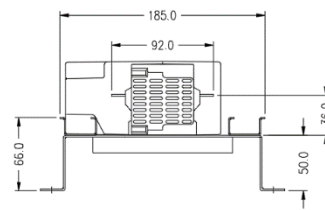

CHASSIS BOTTOM VIEW

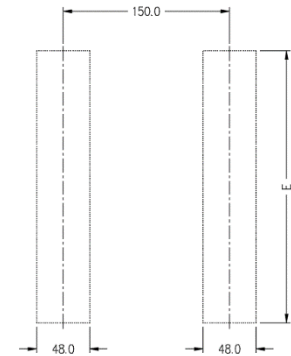

ESCUTCHEON CUTOUTS

Part No.	A	B	C	D	E	Number of Poles
						27mm
ELS6-12/272	79	158	196	228	164	12
ELS6-18/272	160	239	277	309	245	18
ELS6-24/272	241	320	358	390	326	24
ELS6-30/272	322	401	439	471	407	30
ELS6-36/272	403	482	520	552	488	36
ELS6-42/272	484	563	601	633	569	42
ELS6-48/272	565	644	682	714	650	48
ELS6-60/272	727	806	844	876	812	60
ELS6-72/272	889	968	1006	1038	974	72

Catalogue number: **ELS6-□□/□□□□□2**

400A 3 Phase Flat Pan Chassis 18/27mm Pitch



Dimensions for ELS6-□□/18272

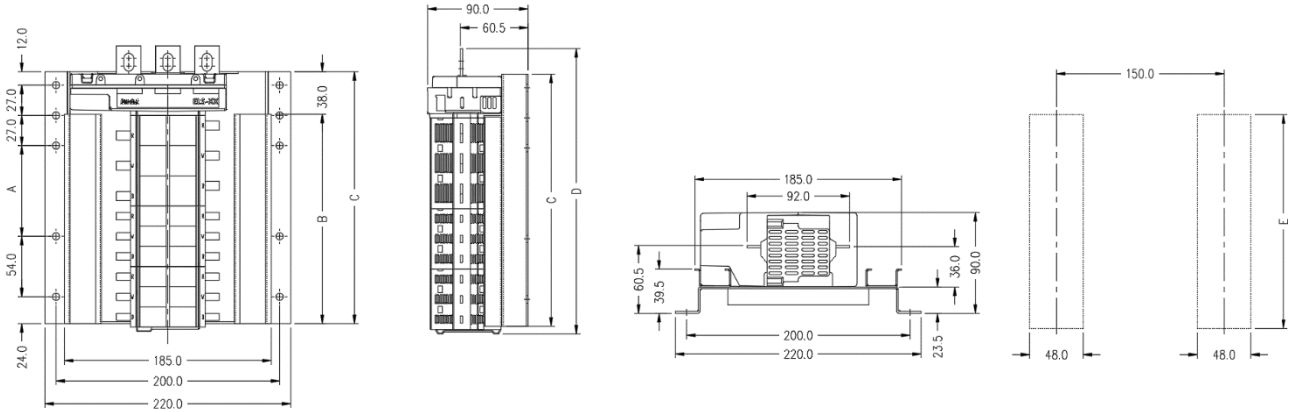

CHASSIS FRONT ELEVATION

CHASSIS SIDE VIEW

CHASSIS BOTTOM VIEW

ESCUTCHEON CUTOUTS

Part No.	A	B	C	D	E	Number of Poles	
						18mm	27mm
ELS6-12/18272	27	133	171	201	137	6	6
ELS6-18/18272	81	187	225	255	191	12	6
ELS6-24/18272	135	241	279	309	245	18	6
ELS6-30/18272	189	295	333	363	299	24	6
ELS6-36/18272	243	349	387	417	353	30	6
ELS6-42/18272	324	430	468	498	434	30	12
ELS6-48/18272	378	484	522	552	488	36	12
ELS6-60/18272	486	592	630	660	596	48	12
ELS6-72/18272	594	700	738	768	704	60	12

