

Catalogue number: **EAT-**□□-□□□□□□□□



250A 3 Phase EMS/ Flat Pan Style Chassis



EMS Style Chassis

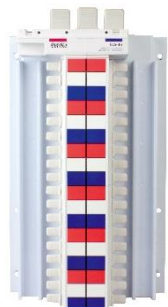

Flat Pan Chassis

250A 3 Phase EMS/ Flat Pan Style Chassis

- Current Rating: 250A
- Encapsulated Busbar
- Withstand Rating 250A 25kA 0.1s, 10kA 1s
- Available in 18 or 27 mm pitch or Hybrid Chassis (18 & 27 mm)
- Option to fit EUR-3-250 main switch to chassis pan
- Split Chassis achieved by installing DB-CB-EUR-SP Bracket
- Standards: Tested to IE61439-2

EAT-

□□-□□□□□□□□

Number of Poles	
12	12 Pole
18	18 Pole
24	24 Pole
30	30 Pole
36	36 Pole
42	42 Pole
48	48 Pole
60	60 Pole
72	72 Pole
84	84 Pole
96	96 Pole

Chassis type	
18EM1	EMS Chassis 18mm Pitch
27EM1	EMS Chassis 27mm Pitch
1827EM1	EMS Hybrid Chassis 18/27mm Pitch
181	Flat Pan Chassis 18mm Pitch
271	Flat Pan Chassis 27mm Pitch
18271	Flat Pan Hybrid Chassis 18/27mm Pitch

Properties			
Manufacturer	Eaton		
Product Range	Eaton 250A EMS Style MCB Chassis Eaton 250A Flat Pan Chassis		
Chassis Type	Encapsulated 250A Main Chassis		
Compatible Product Series	Eaton MCB's : PLS6, PLSM, PLHT Eaton MCB/RCD : ERB6/M		
Busbar Thickness	2.0mm Cu		
Pitch	18mm/27mm		
Rated Current	In	250A	
Rated Operating Voltage	Un	415V	
Rated Insulation Voltage	Ui	440V	
Rated Frequency	50/60HZ		
Rated Short-time withstand Current	Icw	0.1s	25kA
		1s	10kA
Rated Peak withstand Current	Ipk	52.5kA	
Rated Diversity Factor	0.8		
Standard Compliance	AS/NZS 3439.1:2002		
	AS 60529:2004		
	IEC 61439.1 and 61439.2		



N.A.W. Controls Pty. Ltd.
Telephone: (03) 9464 6555
www.nawcontrols.com.au

Eaton EAT 250A MCB chassis
August 2020

250A 3 Phase EMS/ Flat Pan Style Chassis

Dimensions for EAT-□□-18EM1

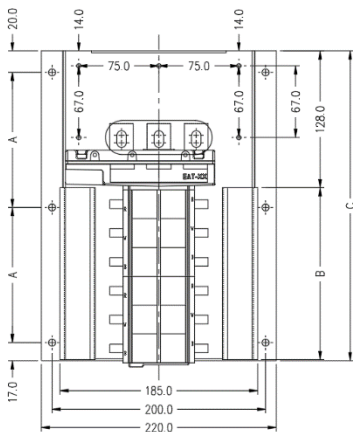

CHASSIS FRONT ELEVATION

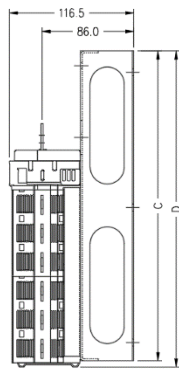

CHASSIS SIDE VIEW

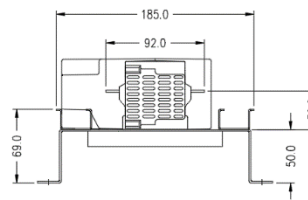

CHASSIS BOTTOM VIEW

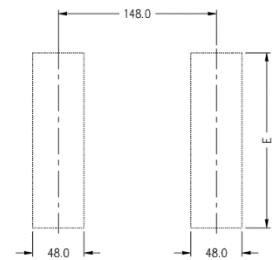

ESCUTCHEON CUTOUTS

Part No.	A	B	C	D	E	Number of Poles
						18mm
EAT-12-18EM1	99	107	236	242	110	12
EAT-18-18EM1	126	161	290	297	164	18
EAT-24-18EM1	153	214	343	350	218	24
EAT-30-18EM1	180	268	397	404	272	30
EAT-36-18EM1	206	321	450	456	326	36
EAT-42-18EM1	233	375	504	511	380	42
EAT-48-18EM1	260	428	557	564	434	48
EAT-60-18EM1	314	535	664	671	542	60
EAT-72-18EM1	367	642	771	778	650	72
EAT-84-18EM1	420	749	878	884	758	84
EAT-96-18EM1	474	856	985	992	866	96

Dimensions for EAT-□□-27EM1

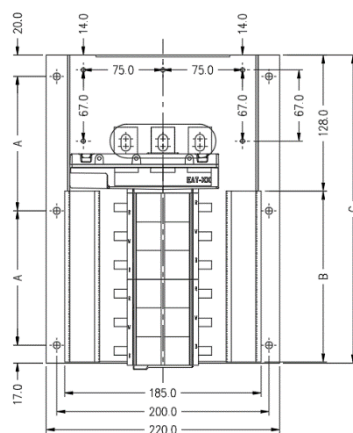

CHASSIS FRONT ELEVATION

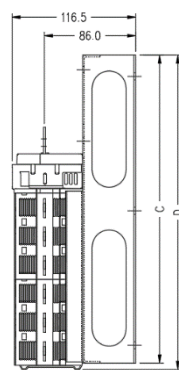

CHASSIS SIDE VIEW

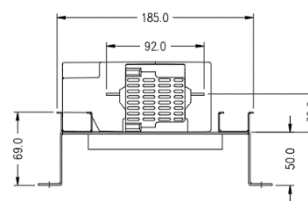

CHASSIS BOTTOM VIEW

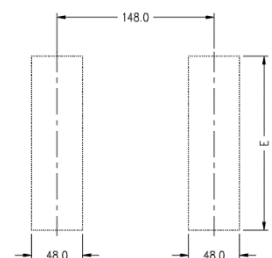

ESCUTCHEON CUTOUTS

Part No.	A	B	C	D	E	Number of Poles
						27mm
EAT-12-27EM1	126.5	161	290	296	164	12
EAT-18-27EM1	167	242	371	377	245	18
EAT-24-27EM1	207.5	323	452	458	326	24
EAT-30-27EM1	248	404	533	539	407	30
EAT-36-27EM1	288.5	485	614	620	488	36
EAT-42-27EM1	329	566	695	701	569	42
EAT-48-27EM1	369.5	647	776	782	650	48
EAT-60-27EM1	450.5	809	938	944	812	60
EAT-72-27EM1	531.5	971	1100	1106	974	72

Dimensions for EAT-□□-1827EM1

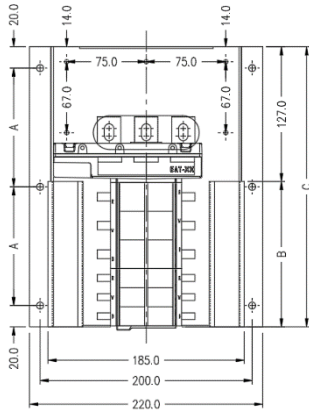

CHASSIS FRONT ELEVATION

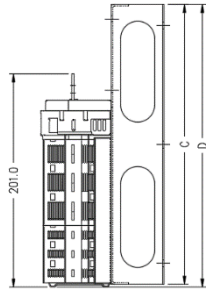

CHASSIS SIDE VIEW

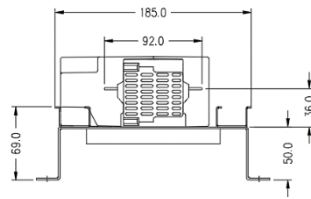

CHASSIS BOTTOM VIEW

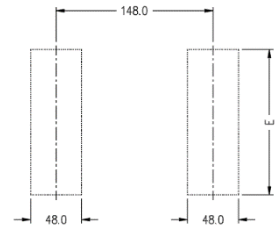

ESCUTCHEON CUTOUTS

Part No.	A	B	C	D	Number of Poles	
					18mm	27mm
EAT-12-1827EM1	112	137	264	267	6	6
EAT-18-1827EM1	139	191	318	321	12	6
EAT-24-1827EM1	166	245	372	375	18	6
EAT-30-1827EM1	193	299	426	429	24	6
EAT-36-1827EM1	220	353	480	483	30	6
EAT-42-1827EM1	260.5	434	561	564	30	12
EAT-48-1827EM1	287.5	488	615	618	36	12
EAT-60-1827EM1	341.5	596	723	726	48	12
EAT-72-1827EM1	395.5	704	831	834	60	12

Dimensions for EAT-□□-181

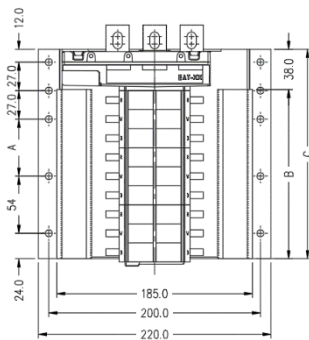

CHASSIS FRONT ELEVATION

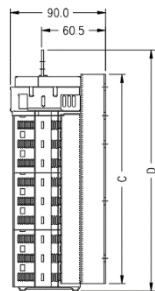

CHASSIS SIDE VIEW

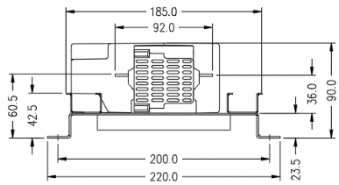

CHASSIS BOTTOM VIEW

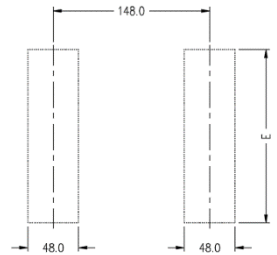

ESCUTCHEON CUTOUTS

Part No.	A	B	C	D	E	Number of Poles
						18mm
EAT-12-181	0	106	144	174	110	12
EAT-18-181	54	160	198	228	164	18
EAT-24-181	108	214	252	282	218	24
EAT-30-181	162	268	306	336	272	30
EAT-36-181	216	322	360	390	326	36
EAT-42-181	270	376	414	444	380	42
EAT-48-181	324	430	468	498	434	48
EAT-60-181	432	538	576	606	542	60
EAT-72-181	540	646	684	714	650	72
EAT-84-181	648	754	792	822	758	84
EAT-96-181	756	862	900	930	866	96

Dimensions for EAT-□□-271

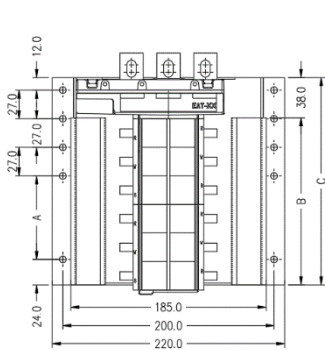

CHASSIS FRONT ELEVATION

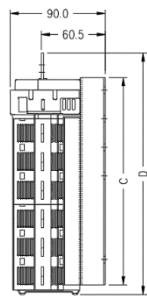

CHASSIS SIDE VIEW

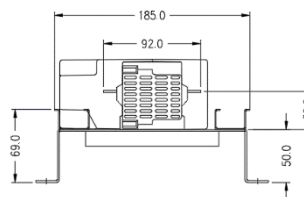

CHASSIS BOTTOM VIEW

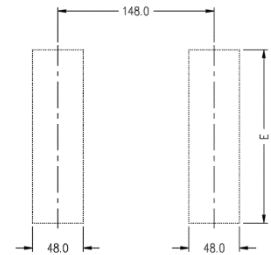

ESCUTCHEON CUTOUTS

Part No.	A	B	C	D	E	Number of Poles	
						18mm	27mm
EAT-12-271	79	158	196	228	164	6	12
EAT-18-271	160	239	277	309	245	12	18
EAT-24-271	241	320	358	390	326	18	24
EAT-30-271	322	401	439	471	407	24	30
EAT-36-271	403	482	520	552	488	30	36
EAT-42-271	484	563	601	633	569	36	42
EAT-48-271	565	644	682	714	650	42	48
EAT-60-271	727	806	844	876	812	54	60
EAT-72-271	889	968	1006	1038	974	60	72

Dimensions for EAT-□□-18271

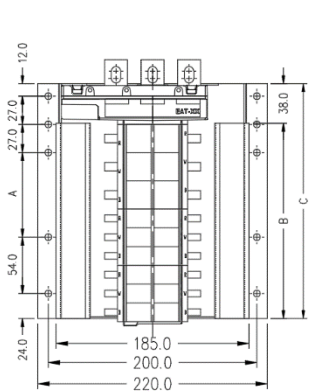

CHASSIS FRONT ELEVATION

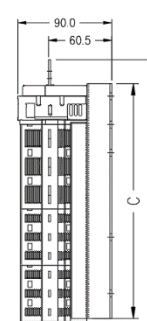

CHASSIS SIDE VIEW

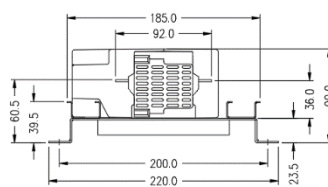

CHASSIS BOTTOM VIEW

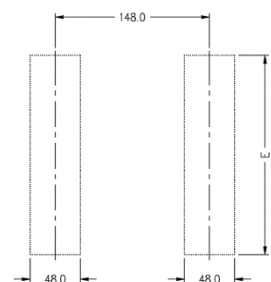

ESCUTCHEON CUTOUTS

Part No.	A	B	C	D	E	Number of Poles	
						18mm	27mm
EAT-12-18271	27	133	171	201	137	6	6
EAT-18-18271	81	187	225	255	191	12	6
EAT-24-18271	135	241	279	309	245	18	6
EAT-30-18271	189	295	333	363	299	24	6
EAT-36-18271	243	349	387	417	353	30	6
EAT-42-18271	324	430	468	498	434	30	12
EAT-48-18271	378	484	522	552	488	36	12
EAT-60-18271	486	592	630	660	596	48	12
EAT-72-18271	594	700	738	768	704	60	12