

7-Inch Touch Button Monitor

IM4TB / IM4TBW



USER MANUAL

Micron 7 Inch Touch Button Monitor

IM4TB – Touch Screen

IM4TBW – Touch Screen – WiFi







Information & specifications contained in this manual maybe changed for the benefit of product development and improvements.

Table of Contents

1. Features and Functions.....	2
2. Packing Contents.....	2
3. Indicators and Connection details	3
3.1 Front & Side	3
3.2 Rear & Bottom	4
4. Connection Diagram	5
4.1 Wiring Diagram	5
5. Monitor Installation	6
6. Operation Description.....	7
6.1 Visitor Call	7
6.2 Monitor Function	8
6.3 Memory.....	8
6.3.1 Image & Video Storage	8
6.3.2 Image & Video Review	8
6.4 Intercom Function.....	9
6.5 Motion Detection – SD Card Required.....	9
6.6 Scheduled Do Not Disturb Function	10
6.7 Screensaver Function	10
6.8 Customization of MP3 melody – SD Card Required.....	11
7. Setting Page.....	12
7.1 Specifications	14
8. WiFi Connection (IM4TBW Only)	14
8.1 Adding a Device – WIFI	14
8.2 Control the Monitor through the APP	16
8.3 Call Forwarding Latency	17
9. Hardwired Connection (IM4TBW Only)	17
9.1 Adding a Device – Hardwired.....	17

WARNING AND CAUTION

Please make sure to follow the instructions to prevent any product danger or product failure.

	Do not attempt to disassemble or repair. This product requires a qualified technician
	Do not install this product in a hot or humid place
	Do not place heavy objects on this product
	Do not use solvents or detergents to clean the product
	Do not attempt any connections whilst the power to the system is on
	Make sure to clean the monitor using a dry cloth to prevent any breakdown or electric shock
	If the product produces excessive noise or smoke, immediately turn off the power, and then contact your service technician
	Make sure that dust does not build up on the product
	Make sure to prevent foreign objects from entering the product
	Do not install in direct rays of the sun or heating devices
	Install the product in a flat and stable place
	Do not remove the micro SD card (if Fitted) when recording, this generally will cause loss of data

1. Features and Functions

Micron 7 inch touch button monitor

Features:

- Built-in WIFI, support IOS & Android APP remote control (IM4TBW only)
- 1080P/720P/CVBS display & record
- Connect up to 2 door stations, 1 master monitor + 3 slave monitors
- Control of automatic gates or Locks (will require additional power supplies)
- Inner flash memory, support micro SD card
- Auto & Manual video and photo recording
- Monitor to Monitor Intercommunication
- Support motion detection from door station
- Selective 16 ringtone melodies, 1 x 1 customized MP3 melody Via SDCARD & PC
- Scheduled do not disturb function
- Screensaver function (date & time display in standby mode)
- Adjustable ringtone, volume & talking volume
- Adjustable brightness, color and contrast

2. Packing Contents

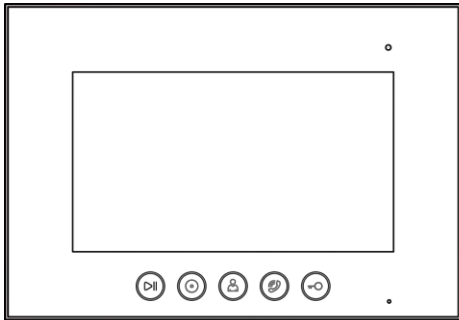

Monitor

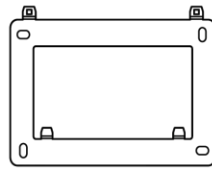

Wall bracket

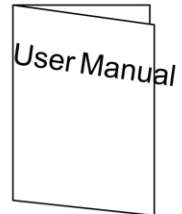

User Manual

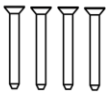

M4*35mm
Mounting Screw



Plastic wall plugs



2 pin connector
to DC power cable



Warranty card



4 pin wiring cable



2 pin power cable



4 pin connector
to RJ45 cable
(Only for IM4TBW)

3. Indicators and Connection details

3.1 Front & Side

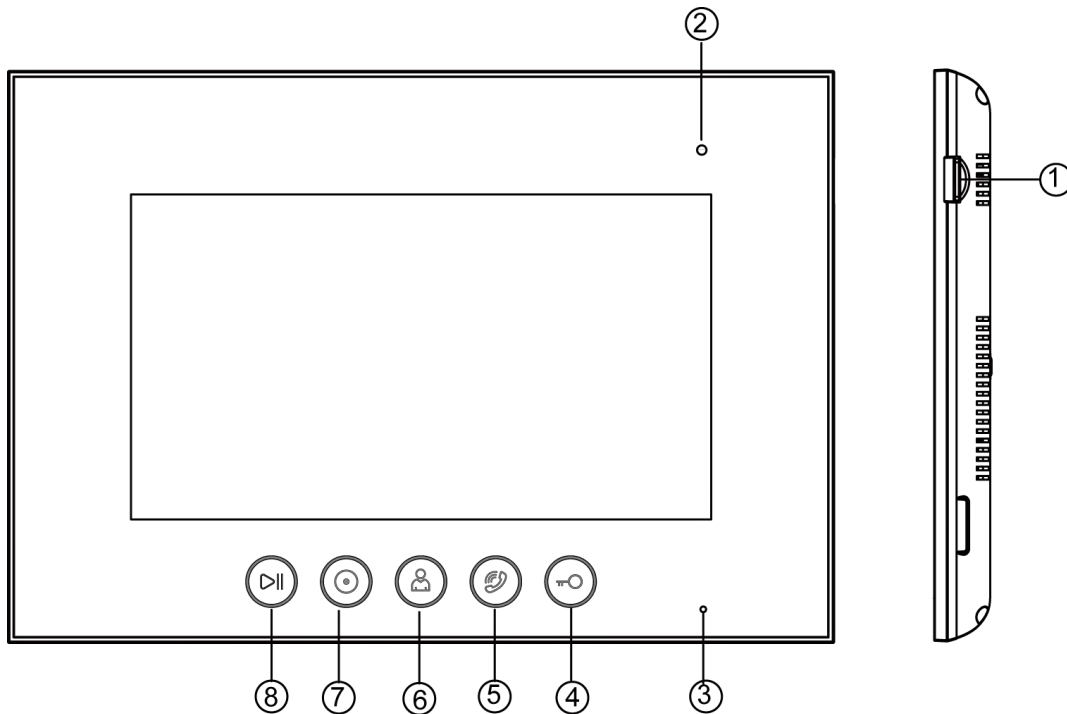

NO.	Part Name	Description
1	Micro SD Card Slot	Micro SD Card Slot
2	Power / Do-not-disturb Indicator	White led – Monitor power is on Led flashing -- Mute function is enable
3	Microphone	Microphone to talk to the door station
4	Unlock Button	Touch button for releasing door lock
5	Talk Button	Touch button for talking with visitor
6	Monitor Button	Touch button for monitoring
7	Intercom Button	Touch button for intercom
8	Memory Button	Touch button for reviewing photo/video

3.2 Rear & Bottom

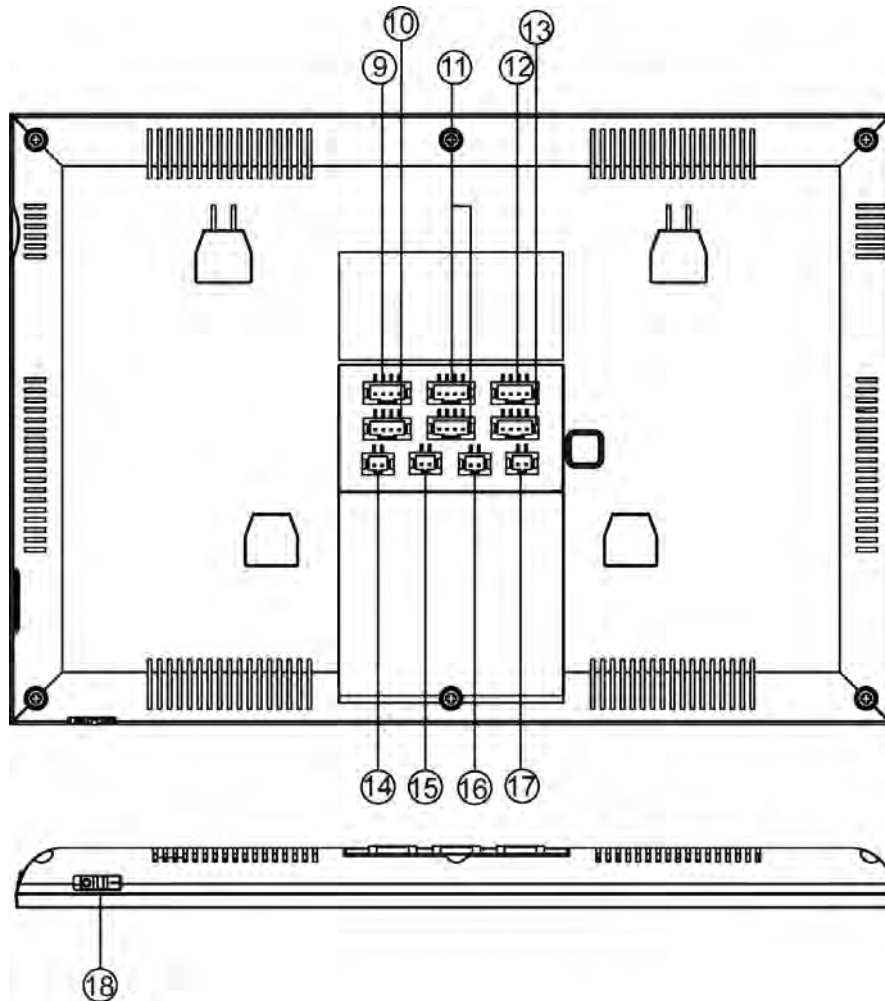

NO.	Part Name	Description
9	CCTV Input	Connection for CCTV 1 & CCTV 2
10	LAN	Connection for home router (IM4TBW only)
11	Video Input	Connection for door station 1 & door station 2
12	Intercom Output	Connection In for additional Monitor
13	Intercom Input	Connection Out for additional Monitor
14	CCTV Output	NOT USED –Video Output
15	HOOK	NOT USED - Technical connection
16	DC Power Input	Power supply input
17	Relay Output	Normally Open Relay output
18	Power Switch	On / Off Switch for Monitor

4. Connection Diagram

4.1 Wiring Diagram

Wiring Example of Intercom with one monitor and optional 2nd door station.

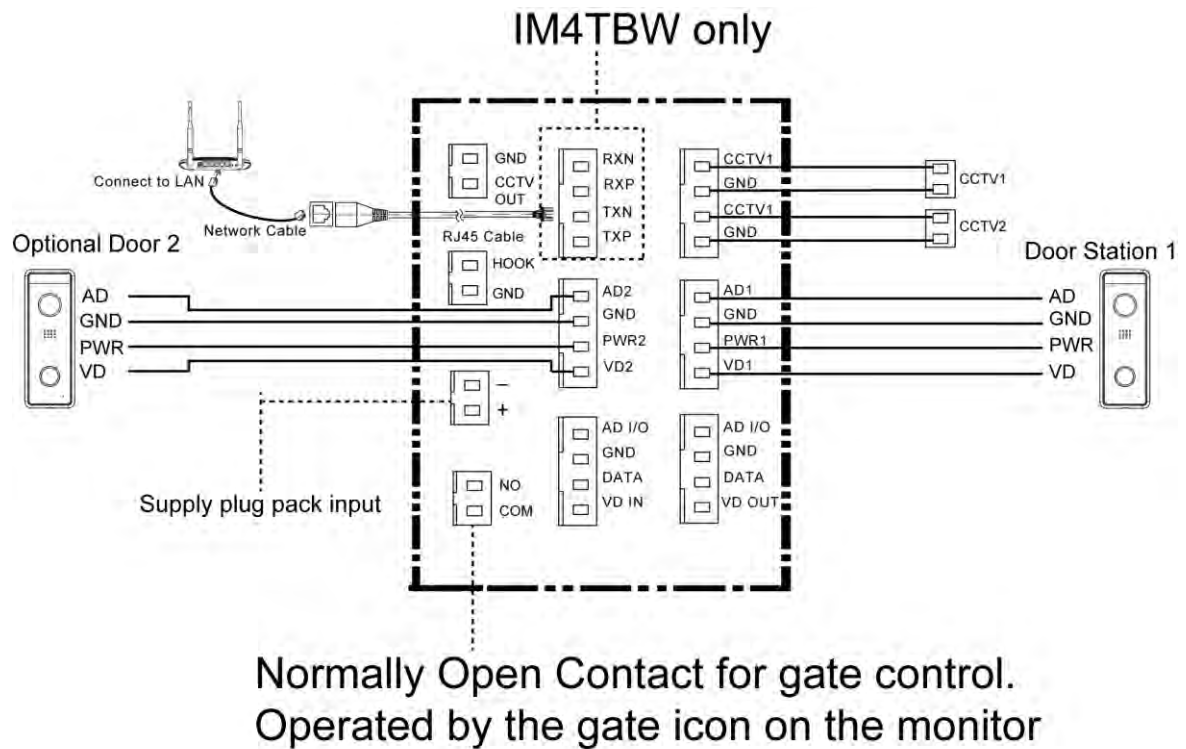

Note: Total Maximum Cable Distance is 100 meters.

Wiring Example of Intercom with one monitor, 2 Slaves and optional 2 door stations.
MAXIMUM CABLE DISTANCE IS 100 METERS

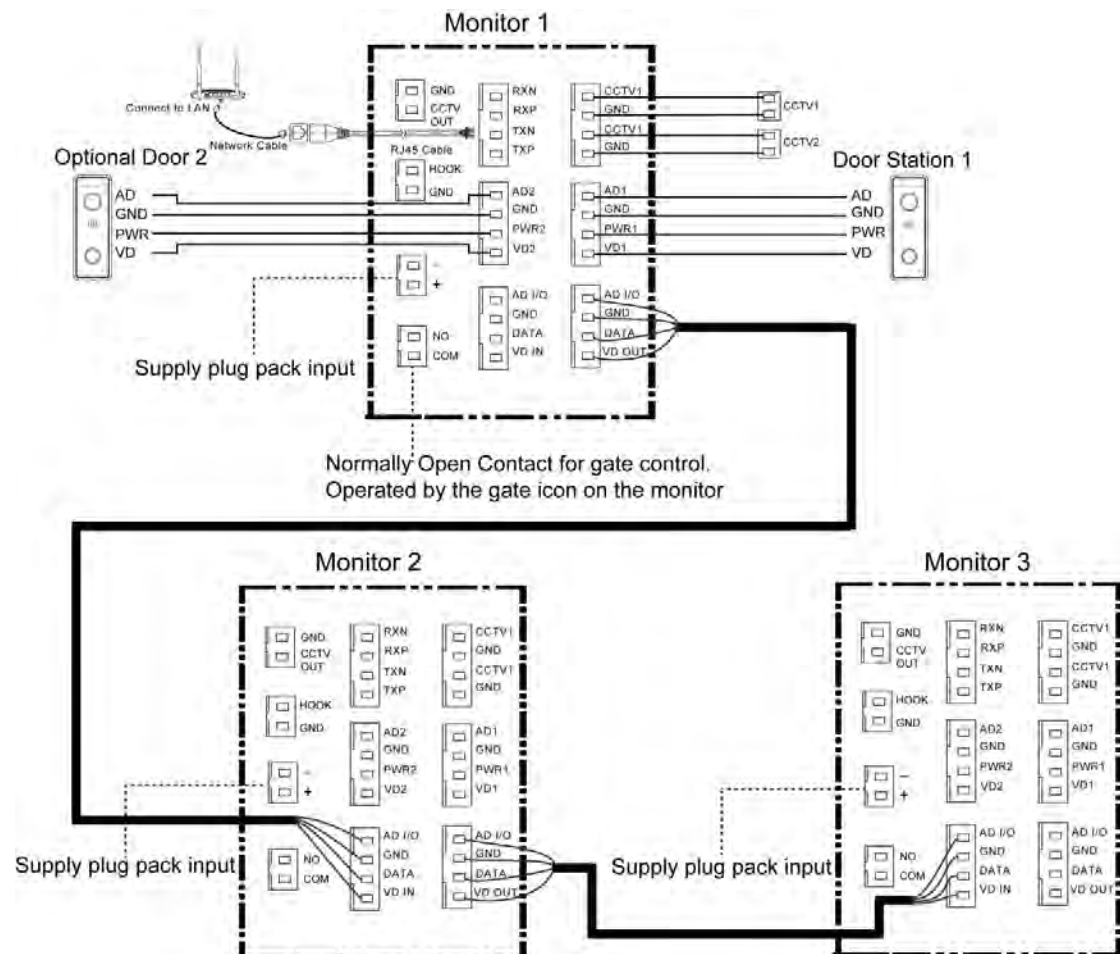

Note:

1. Normally Open Contact can only switch 100mA and only operates from the gate unlock button.

5. Monitor Installation

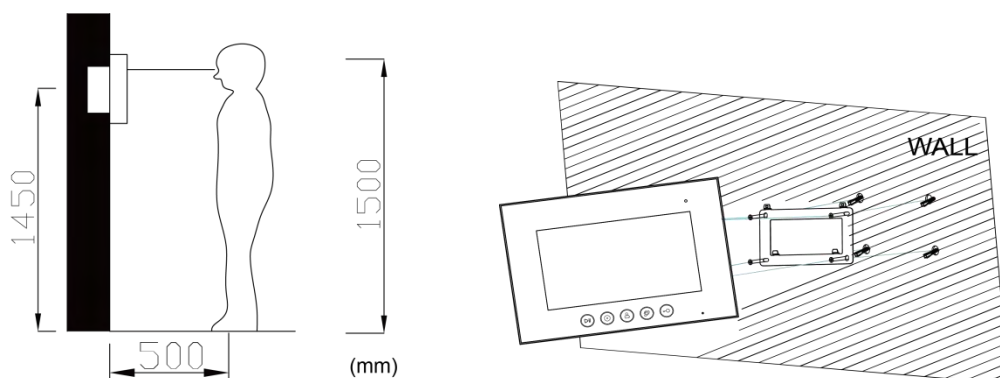

Standard monitor installation height is about 1,500mm where screen center is at eye level; in this case, wall-hanging metal center is 1,450mm above ground level.





6. Operation Description

6.1 Visitor Call

When door station calls in, the visitor's image will be shown on the monitor screen and you can touch  to talk with the visitor and touch it again to terminate the talk.



※ Icon Definition

	Short touch for capturing a picture; Long touch for recording a video.		
	Short touch for call transfer manually; Long touch for opening the third gate.		
	Short touch for switching between door stations and CCTV cameras; Long touch for adjusting display parameters(brightness/color/contrast) and volume.		
	Talk with visitor.		release the electronic lock.

During the talk:

- You can record a video or capture a picture from the calling door station automatically depending on the system setting.
- You can touch  to switch to other door station or CCTV camera, and the current

conversation will be terminated.

- You can touch  to transfer the current call to other extension monitors.

6.2 Monitor Function

Touch  when device is on standby, the system will enter monitor mode, and will show image from the corresponding door station.

6.3 Memory

6.3.1 Image & Video Storage

The monitor can record images and videos with inner flash storage. It also supports mirco SD card. Max 128GB ****Not Supplied****

When the memory is full, the newest picture/video will automatically overwrite the oldest image/video.

6.3.2 Image & Video Review

Touch  when device is on standby, you can review the image/video that have stored in memory. The picture/video list with gray means that the picture/video is viewed, and the white list means that the picture/video is not viewed. You can choose the corresponding list directly to review the saved pictures /video.





Note:

- Micro SD card must be formatted by the monitor to function correctly.
- Micro SD card is excluded in the package.
- The videos include both the video recorded during monitoring and recorded during motion detection.

- In standby mode  will flash when has new photo/video.

6.4 Intercom Function

Touch  when device is on standby, you can choose the monitor that you want to call, and then touch  to start the call, and you can talk with the corresponding monitor if the called monitor answers the call. The talking and ringtone volume for intercom can be adjusted.



6.5 Motion Detection – SD Card Required

The monitor supports motion detection from door station. You can enable/disable the motion detection function, set a door station as default for motion detection, set

the sensitivity and frame rate and the time range of motion detection in



setting page. Via The Micron Intercoms + APP you can enable/disable motion detection notification. If enabled and motion is detected, you will receive a motion detection message on your phone.



6.6 Scheduled Do Not Disturb Function

The monitor supports scheduled do not disturb function. You can enable/disable the mute function and set the time range of do not disturb mode in  setting page.



6.7 Screensaver Function

The monitor supports screensaver function (date & time display in standby mode).

You can enable/disable screensaver function in  setting page.



6.8 Customization of MP3 melody – SD Card Required

The Intercom supports 16 preprogrammed melodies and will support a customized an extra MP3 melody for Door 1, Door 2 and Internal intercommunication by SD card. You can customize MP3 as the following:

1. Prepare a SD card and format it;
2. Open the SD card on your computer, and create a new folder called melody;
3. Open the melody folder, and create folder CAM1, CAM2, Intercom;

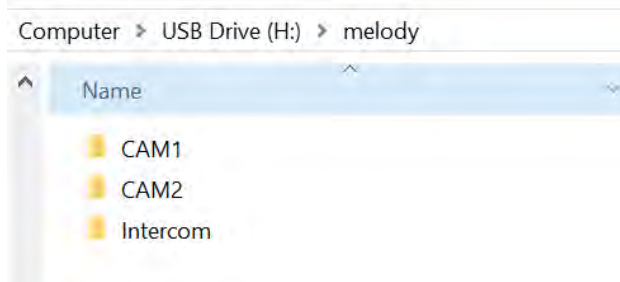

4. Copy your music to the CAM 1 or CAM 2 or Intercom folder.
5. Install the SD card into the Monitor in the SD Card Slot;

6. Open the setting page and open the  setting page, the device will import music automatically;



7. Then you can choose the new melody you add, and the melody will be named MP3.

Note:

- Please notice the melody must be in MP3 or WAV format;

- The Ring time of device is 5/10/20s, so the melody should have no prelude;
- You can add a piece of music separately in DOOR 1 and DOOR 2 and Intercom.
- If the SD card is not recognized, please format it on the device.

7. Setting Page

Touch  or  when the device is on standby, and then the screen will enter main setting page.



IM4TBW





IM4TB

- In the WiFi  setting page, you can turn WiFi on or off and set call forwarding

latency for the monitor,you can also reset WiFi setting.

- In the Motion detection  setting page, you can turn Motion detection on or off, set one camera as default for motion detection, setsensitivity,motion detectionframe rate and time range of motion detection. Enable or disable the motion detection notification.

- In the Date  setting page,you can set the date & time of the monitor and select the date format.

- In the Address  setting page, you can set the intercom address of the monitor. The address of two monitors cannot be the same in one system.

- In the Mute  setting page,you can enable/disable the mute function and set the time range of do not disturb function.

- In the Melody  setting page, you can set the ring tone for Door station 1 and Door station 2 (Selective 6 melodies and support 1 customized MP3 melody) and also set ring time(5s/10s/20s).

- In the Memory  setting page,you can delete all pictures or videos in the internal Flash memory of the monitor and also on the Micro SD card if fitted. You can also copy all the saved pictures/videos in the Flash memory to the micro SD card . You can also format micro SD card.

- In the General  setting page, you can set the language of the monitor and restore the monitor to factory default. Date and time and the room station number will not be reset.You can also enable/disable the screensaver function.You can set the unlock time for door1, door2, and the gate(1s/3s/5s/7s/9s). You can also disable the inputs like DOOR 2/CCTV1/CCTV2 channel so they will not appear on the preview page of the monitor or the APP. And you can also enable/disable the backlight of touch button.

- In the Record  setting page,you can turn Monitor record on / off and select picture or video record mode.

Note:

- If you set the intercom address to Ext1./Ext2./Ext3./Ext4./Ext5, the WiFi will be

unavailable.

- Once a moving object is detected, the monitor will record a video automatically(the duration of recording video is 60s). When monitoring door station or CCTV, motion detection will pause until the monitoring ends.

7.1 Specifications

Category	Specification
Input power	DC: 15V.
TFT LCD	7 inch digital TFT LCD.
LCD resolution	1024(RGB) x 600.
Supported video input signal type	AHD: support 1080P/720P; TVI: support 1080P/720P; CVI: support 1080P/720P; CVBS: support.
Connection with door station	Support two 4-wire door stations.
Connection with extension monitor	Support 3 extension monitors.
Connection with CCTV	Support two 2-wire CCTV input.
Memory capacity	Inner Flash: 10M for images, 40M for videos Micro SD card: 8G~ 128G
Dimensions (mm)	222(W) x 154(H) x 15(D)(without wall bracket)

8. WiFi Connection (IM4TBW Only)

8.1 Adding a Device – WIFI

The monitor can connect to the Internet by WIFI to your router / modem. The WiFi settings for the monitor are programmed from the mobile device which has the Micron Intercoms + APP installed on it. The APP is available from the Play store for Andriod or the App Store for IOS

✂To add a new device

1. Reset WiFi setting in the monitor before starting any configuration. Your Smart Device needs to be connected to the home WiFi;
2. Download and open the Micron Intercoms + APP, press the “+” icon;
3. Scan the UID /QR code on the Monitor WiFi page;
4. Click next, and choose the SSID (name) of home router and enter the Home Wi-Fi password;
5. Click next, and then the APP will configure the device through sound waves;
6. Waiting the device online;

7. After the device configure successfully, you can set device name and save.

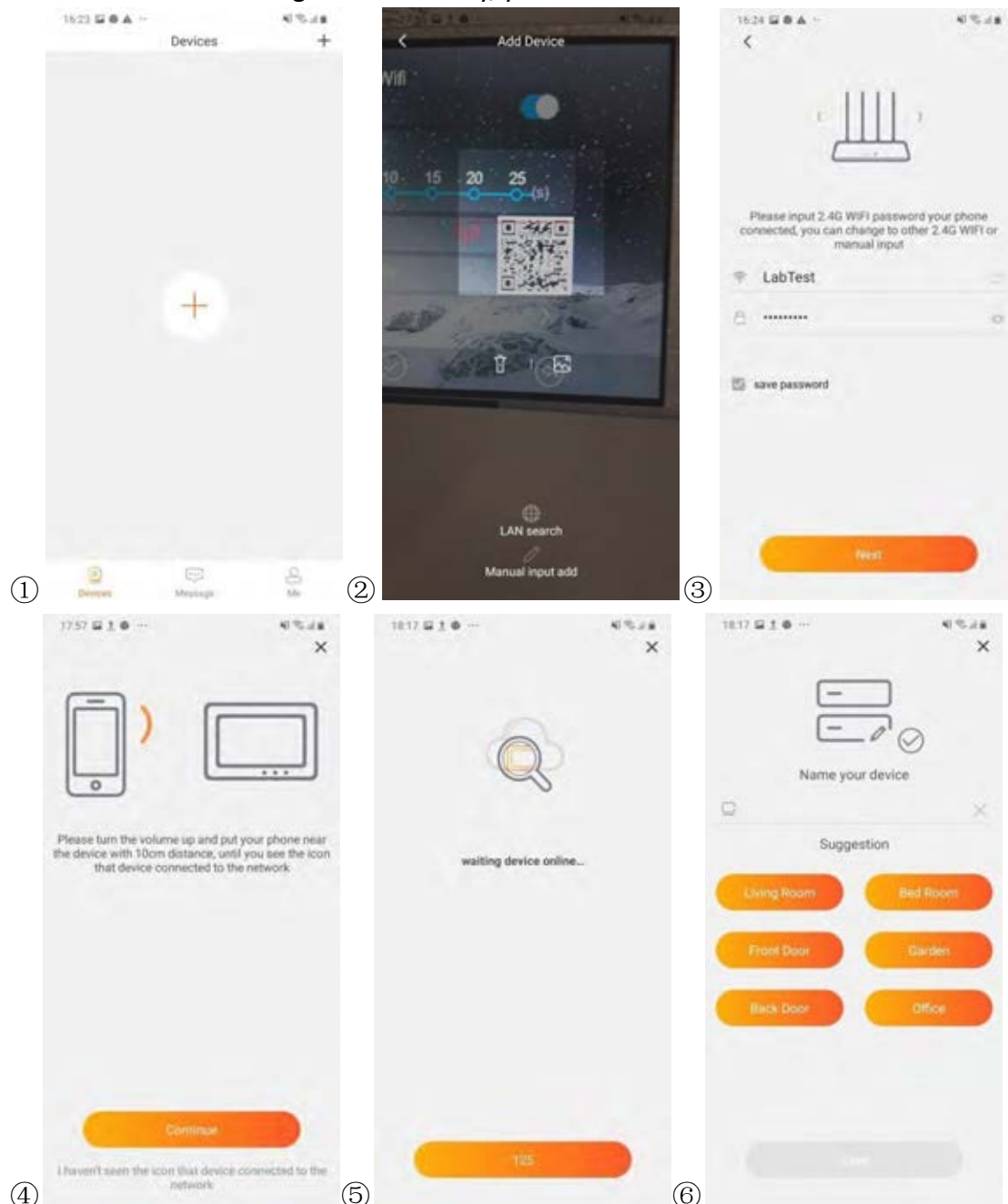

Note:

- The home router must be connected to external networks if the call from door station needs to be transferred to your mobile phone;
- In order to ensure normal connection, all permissions of the APP need to be allowed;
- The UID / QR Code of each monitor is unique;

✳ Add a second user to a connected device

1. Download and open the **Micron Intercoms + APP**, click the “+” icon;
2. Scan the device UID QR code in device WIFI page;







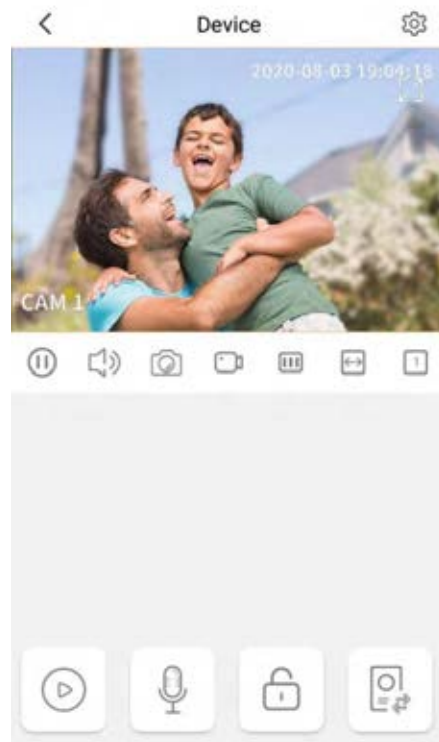
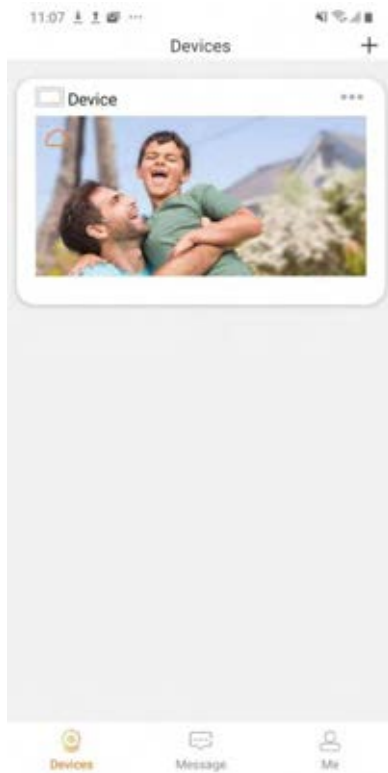







3. If the device is online, you can input the password and add it.

8.2 Control the Monitor through the APP

1. Select the device you want to connect to and enter the monitor page(when you first use it, it will remind you to modify the default password);
2. Press the setting icon at the upper-right corner and turn “Ring Alerts” to ON;
3. When door station calls in, the mobile phone will receive message and show ringing page;
4. Press the accept icon and talk with the visitor;
5. Press the corresponding lock icon, and then you can release the door lock and open the automatic door; if you press the setting icon at the upper-right corner and disable “Quick to unlock”then you will have to input your password to unlock.
6. The monitor screen on the Mobile phone can be switched to fullscreen display mode;
7. Press the record playback, you can preview the photo/video which is recorded.



※ Icon definition

	play/pause		record a video
	unmute/mute		capture a picture
	change display size		change preview frame rate
	Multi-device preview		talk
	record playback		release door lock
	release the electric lock		open the automatic door
	Switch preview channel		full-screen display

8.3 Call Forwarding Latency

In the monitor WiFi setting page, the "call forwarding latency" refers to set time delay before forwarding the call to the mobile.

9. Hardwired Connection (IM4TBW Only)

9.1 Adding a Device – Hardwired

The monitor can be connected to the Internet by wiring directly to your router / modem using the supplied 4 pin adapter.

1. Connect your smart device to the home Wi-Fi;
2. Go into the monitor WiFi settings and turn off;
3. Download and open the Micron Intercoms + APP, press the "+" icon";
4. Scan the UID / QR Code on the Monitor WiFi page and press save;
5. On your first connected please change the default password;
6. You can set the device name in the APP settings after configured successfully.

Note:

- If You replace your SIM card or change phones, you will need to restart "Ring Alerts" to ensure that the mobile phone will receive notifications.