

Velocity® Series Small Rose Door Handles



The Velocity 55mm Series is a stylish range of door furniture suitable for both residential and semi commercial applications. Designed primarily for new installation on timber doors, the range incorporates functionality for use with Mortice Locks in addition to Passage, Privacy and Dummy Levers.

Installation

Suits door preparations up to 45mm.

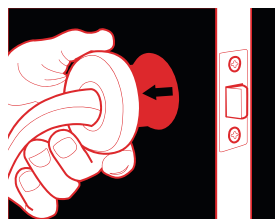

1 Align **2 Twist** **3 Tighten**



Features and Specifications

- All fixings are concealed beneath a removable rose trim providing an aesthetically appealing installation.
- Simple twist and tighten fixing method and pre-assembled lever sets allow for super easy and fast installation.
- Lever range includes two AS1428.1 compliant levers and six designer levers.
- Accessories include AS1428.1 compliant turn, standard turn and privacy indicating emergency turns.
- The 55mm rose suits up to 45mm door preparations commonly used with mortice locks or latches.
- Designed in Australia for the specific needs of the Australian market.

Product Details

Rose Dimensions	55mm by 12.5mm - Round Rose 58mm by 12.5mm - Square Rose
Materials	All Velocity 55mm levers and roses are made from solid zinc die-cast.
Latches	Passage sets are available with a 60mm backset tubular latch. Privacy sets are supplied with a 60mm backset privacy latch which includes a locking pin for the inside of the door and an external emergency release function. The latch is automatically released when the internal handle is operated and is easily adapted for both open in and open out applications. All latches are supplied with industry standard "D" strikes.
Door Thickness	32mm to 45mm hinged doors
Finishes	Satin Chrome Brushed (SC) Chrome Plate (CP) Satin Pearl (SP) Display Pack Range Only

Standards and Compliance



Successfully tested up to 2 hours on fire door assemblies in accordance with the Australian Standard AS1905.1 2005 - Part 1: Fire Resistant Doorsets

D8

VEL Series lever sets have been successfully tested to conform with Level D8 (500,000 cycles) under Australian Standard AS4145.2-2008, Locksets and hardware for doors and windows.



VEL Series in brushed satin chrome finish has been successfully tested to conform with Level C10 (1000 hours) under Australian Standard AS4145.2-2008, Locksets and hardware for doors and windows.



AS1428.1 Compliance. The range includes AS1428.1 compliant levers and turns as shown.

Velocity® Series Small Rose Door Handles

AS1428.1 Compliant Levers

Accession® - Lever 5

Length 121mm

Projection 56.5mm

Finger Clearance 38.4mm



Disabled Accessible
AS1428.1

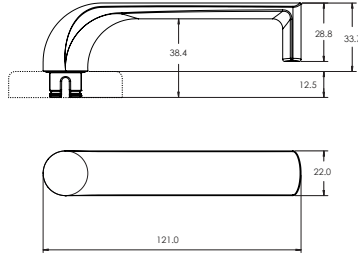

Dianella™ - Lever 8

Length 121mm

Projection 51mm

Finger Clearance 38mm



Disabled Accessible
AS1428.1

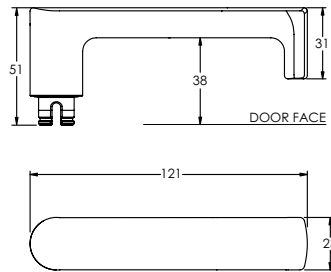

Gidgee® - Lever 37

Length 120mm

Projection 64mm

Finger Clearance 38.5mm



Disabled Accessible
AS1428.1

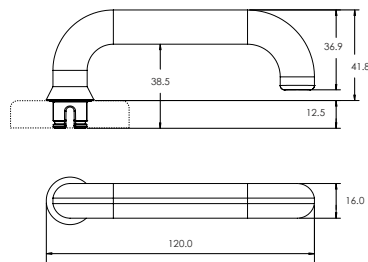

Standard Levers

Element™ - Lever 3

Length 122mm

Projection 54.5mm

Finger Clearance 47.5mm

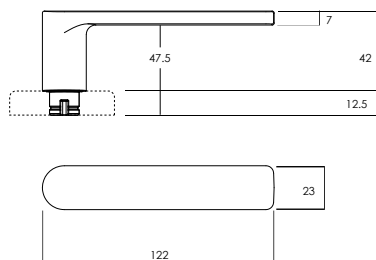

Velocity® Series Small Rose Door Handles

Standard Levers

Hakea® - Lever 28

Length	121mm
Projection	63mm
Finger Clearance	43mm

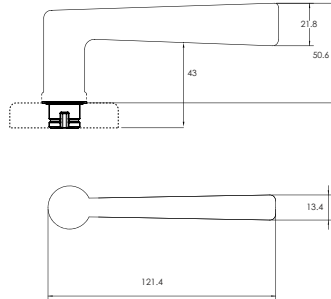

Acacia® - Lever 29A

Length	120mm
Projection	64mm
Finger Clearance	41.5mm

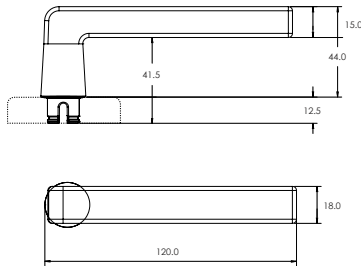

Saltbush® - Lever 34

Length	120mm
Projection	64mm
Finger Clearance	43.5mm

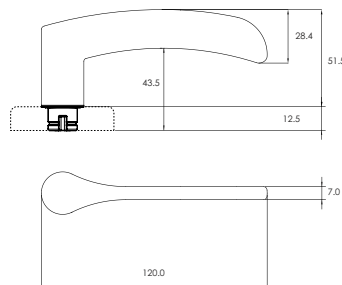

Velocity® Series Small Round Rose Accessories

Euro Cylinder Escutcheon

Part Number	VSR5
Height	55mm
Depth	12.5mm

Supplied with
2x Wood Screws

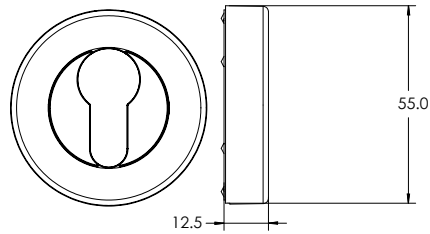

Oval Cylinder Escutcheon

Part Number	VSR6
Height	55mm
Depth	12.5mm

Supplied with
2x Wood Screws

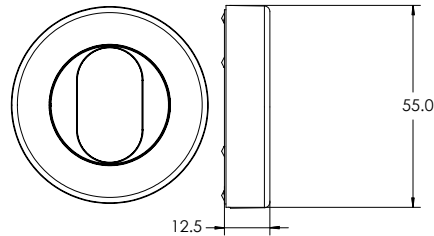

Standard Turnknob

Part Number	VSR7
Height	55mm
Depth	12.5mm
Handing	Not required

Supplied with
2x Wood Screws
1x Short Tail Bar
1x Medium Tail Bar
1x Tail Bar Spring
1x Instructions (1220-321)

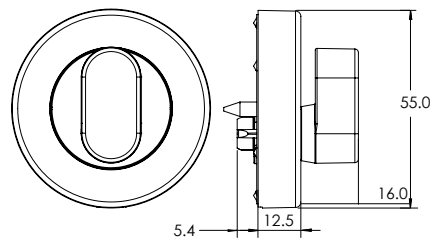

Privacy Indicating Emergency Turn

Part Number	VSR8
Height	55mm
Depth	12.5mm

Supplied with
2x Wood Screws
1x Emergency Tail Bar
1x Instructions (1220-321)

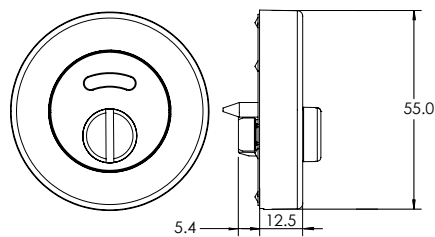

Velocity® Series Small Round Rose Accessories

Disabled Accessible Turnknob

Part Number	VSR9
Height	55mm
Depth	12.5mm
Turn Snib Length	52mm
Handing	Site handable

Supplied with

- 2x Wood Screws
- 1x Tail Bar (short)
- 1x Tail Bar (medium)
- 1x Tail Bar Spring
- 1x Instructions (1220-321)

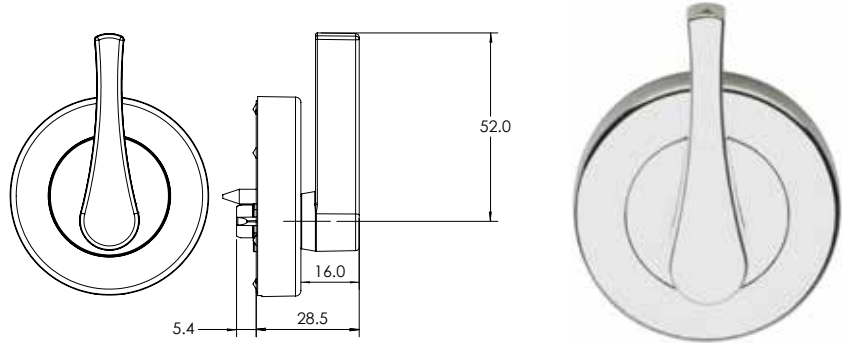

*VSR9 is not compatible with Selector series mortice locks.

Round Rose Passage Trim

Part Number	VSR1-TRIM
Height	55mm
Depth	12.5mm
Quantity	Pack of 2

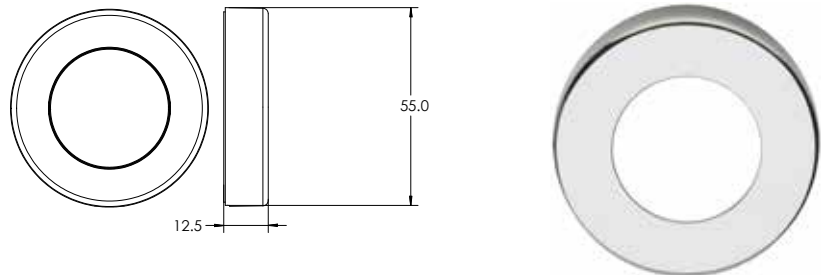

Round Rose Privacy Trim

Part Number	VSR2-TRIM
Height	55mm
Depth	12.5mm
Quantity	Pack of 2

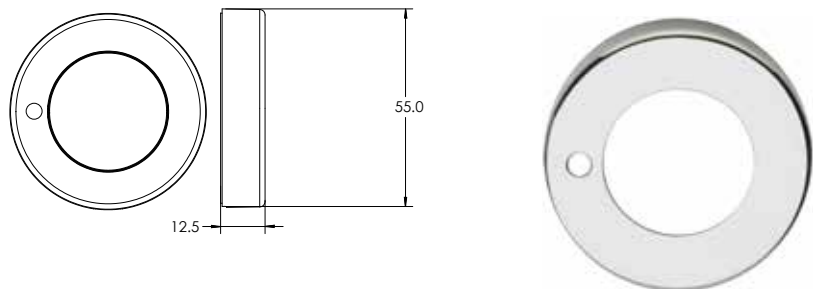

Velocity® Series Small Square Rose Accessories

Euro Cylinder Escutcheon

Part Number	VSS5
Height	58mm
Depth	12.5mm

Supplied with
2x Wood Screws

Note: Please ensure clearance between lever trim and escutcheons when used with European Mortice Locks.

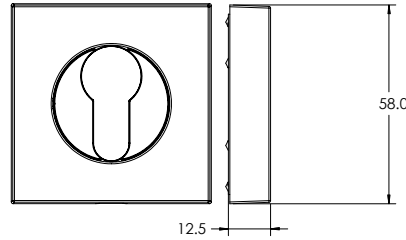

Oval Cylinder Escutcheon

Part Number	VSS6
Height	58mm
Depth	12.5mm

Supplied with
2x Wood Screws

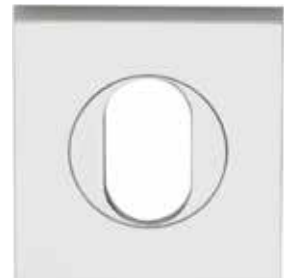
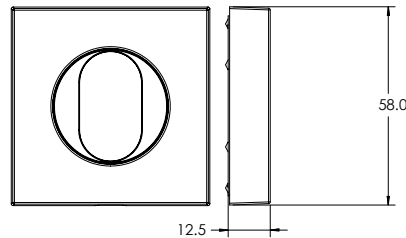

Standard Turn Snib

Part Number	VSS7
Height	58mm
Depth	12.5mm
Handing	Not required

Supplied with
2x Wood Screws
1x Short Tail Bar
1x Medium Tail Bar
1x Tail Bar Spring
1x Instructions (1220-321)

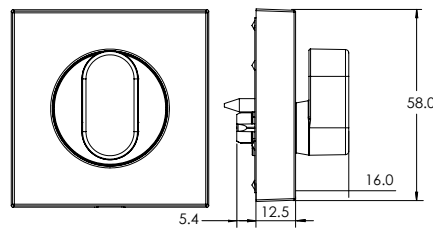

Emergency Indicating Turn

Part Number	VSS8
Height	58mm
Depth	12.5mm
Handing	Not required

Supplied with
2x Wood Screws
1x Emergency Tail Bar
1x Instructions (1220-321)

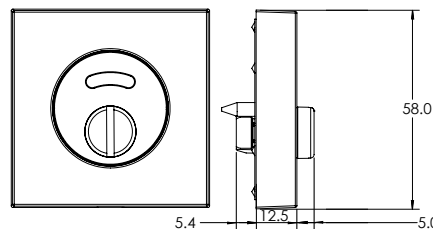

Velocity® Series Small Square Rose Accessories

Disabled Accessible Turn Snib

Part Number	VSS9
Height	58mm
Depth	12.5mm
Turn Snib Length	52mm
Handing	Site handable

Supplied with

- 2x Wood Screws
- 1x Tail Bar (short)
- 1x Tail Bar (medium)
- 1x Tail Bar Spring
- 1x Instructions (1220-321)

*VSS9 is not compatible with Selector series mortice locks.

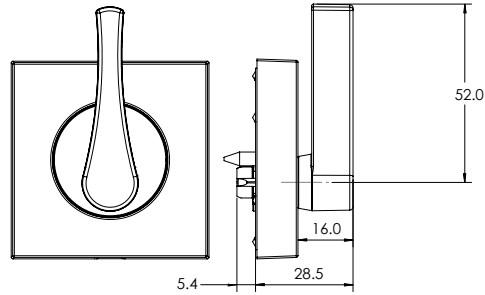

Square Rose Passage Trim

Part Number	VSS1-TRIM
Height	58mm
Depth	12.5mm
Quantity	Pack of 2

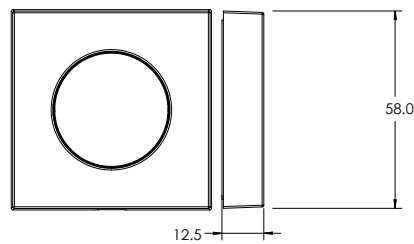

Square Rose Privacy Trim

Part Number	VSS2-TRIM
Height	58mm
Depth	12.5mm
Quantity	Pack of 2

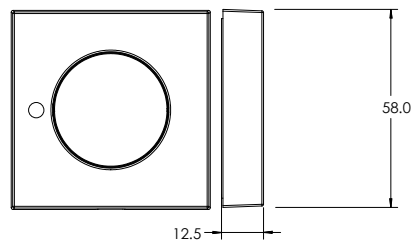

Velocity® Series Rose Door Handles

Sample part number VSR1/L3SC is made up of several sections. Choose your product by selecting an option from each section.

Velocity® Small Rose Series - Trade Pack Range

Exterior Rose	Function	Lever Types	Finish				
VSR	1	L3	SC				
Rose Type	Function	Levers	Finish	Packaging			
Velocity 55mm Round Rose	Mortice 0	Summit® L1	Satin Chrome Brushed SC	Trade Pack			
Velocity 58mm Square Rose	Passage 1	Element™ L3	Chrome Plate CP				
	Privacy 2	Glide™ L4	Matt Black MBK				
	Dummy Half 3	Hakea® 28					
	Euro Escutcheon 5	Acacia® 29A					
	Oval Escutcheon 6	Saltbush® 34					
	Standard Turnknob 7	AS1428.1 Compliant Levers					
	Privacy Indicating Emergency Turn 8	Accession® L5					
	Disabled Accessible Turnknob 9	Dianella™ L8					
		Gidgee® 37					

Note: Mortice, Passage, Privacy and Dummy Half Lever Sets only available in Round Rose. See below for ordering procedure

Velocity® Small Rose Series - Display Pack Range

Rose Type	Function	Lever Types	Finish	Packaging		
VSR	1	L3	SC	DP		
Rose Type	Function	Levers	Finish	Packaging		
Velocity 55mm Round Rose	Passage 1	Summit® L1	Satin Chrome Pearl SP	Display	DP	
	Privacy 2	Spire® L2	Chrome Plate CP			
		Element™ L3	Satin Chrome Brushed SC			
		Glide™ L4				

Square Rose Ordering Procedure

Function	Satin Chrome Finish	Chrome Plate Finish	Satin Pearl Finish	Matt Black Finish
Mortice Lever Set				
Passage Lever Set	VSS1-TRIMSC	VSS1-TRIMCP	VSS1-TRIMSP	VSS1-TRIMMBK
Dummy Half Set				
Privacy Lever Set	VSS2-TRIMSC	VSS2-TRIMCP	VSS2-TRIMSP	VSS2-TRIMMBK

Square Rose Lever Sets are ordered in the same manner as Round Rose Lever Sets above with the addition of a Square Rose Trim Pack. For example a Mortice Lever Set, Lever 5 in Satin Chrome will require both VSR0/L5SC and VSS1-TRIMSC.

Metal Finishes

For Metal Finish sample refer to code under each image.



Antique Copper (AC)
Sample Code: FIN-SAMPLEAC*



Architectural Bronze Unlacquered (AU)
Sample Code: FIN-SAMPLEAU*

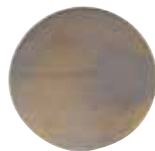

Oil Rubbed Bronze (ORB)
Sample Code: FIN-SAMPLEORB*

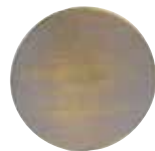

Aged Brass (AG)
Sample Code: FIN-SAMPLEAG*



Architectural Bronze (AZ)
Sample Code: FIN-SAMPLEAZ**



Polished Brass (PB)
Sample Code: FIN-SAMPLEPB**



Satin Brass (SB)
Sample Code: FIN-SAMPLESB**



Polished Brass Unlacquered (BU)
Sample Code: FIN-SAMPLEBU*



Satin Brass Unlacquered (SBU)
Sample Code: FIN-SAMPLESBU*



Satin Chrome Plating (SC)
Sample Code: FIN-SAMPLESC



Chrome Plating (CP)
Sample Code: FIN-SAMPLECP



Stainless Steel (SS)
Sample Code: FIN-SAMPLESS



Polished Stainless Steel (PS)
Sample Code: FIN-SAMPLEPS



Natural Anodized Aluminium (NT)
Sample Code: FIN-SAMPLENT

NOTE: Not all decorative finishes apply to every Lockwood product. Refer to the table at the end of this document for specific decorative finishes applicable per series.

*Unlacquered Metal Finish. This finish will naturally age and its appearance will change over time according to the environment and use it is exposed to. For more information on the aging effect of a particular finish contact your ASSA ABLOY representative.

**Finish is protected by a top clear lacquer.

Disclaimer: Product Colours displayed in this catalogue have been matched to indoor viewing and colour appearance may vary according to light source and medium and as such should be used as indicative only. As actual colour on the end product may vary, always confirm your colour choice with production line prepared samples from your ASSA ABLOY representative for final colour approval. For warranty terms and conditions on Lockwood Products and its finishes, please visit www.lockweb.com.au or call 1300WARRANTY

Dulux Powdercoat Finishes

For Powdercoat Finish sample order code:

FIN-SAMPLEPC specify the desired color from the images below when placing order.



Dulux Duratec Eternity
Eternity Charcoal Pearl
Satin



Dulux Electro
Black Ace
Flat



Dulux Electro
Dark Bronze
Flat



Dulux Electro
Medium Bronze
Flat

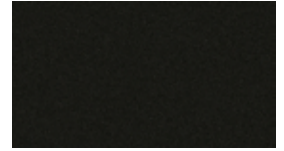

Dulux Precious
Charcoal Metallic Pearl
Gloss



Dulux Precious
Citi Pearl
Matt



Dulux Precious
Natural Pearl
Matt



Dulux Precious
Nickel Pearl
Matt



Dulux Precious
Sharp Silver Kinetic® Pearl
Satin



Dulux Precious
Silver Kinetic® Pearl
Satin

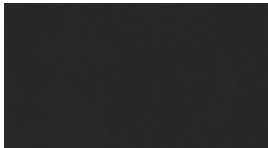

Dulux Surreal Effects Mannex
Mannex Black
Effect



Dulux Surreal Effects Scylla
Red Brown Scylla
Effect

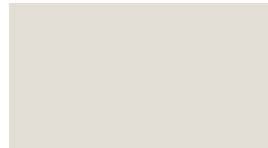

Dulux Duralloy
Shoji White
Satin

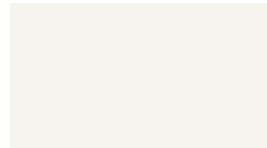

Dulux Alphatec
White
Matt

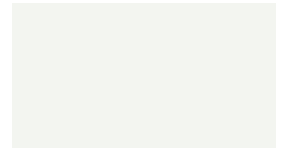

Dulux Duralloy
White
Satin



Dulux Duralloy
Black
Gloss



Dulux Duralloy
Monument®
Satin

CB



Dulux Duralloy
Black (C/B Night Sky®)
Satin

CB



Dulux Duralloy
Dune®
Satin

CB



Dulux Duralloy
Woodland Grey®
Satin

CB



Dulux Duralloy
Jasper®
Satin

CB



Dulux Duralloy
Monument®
Matt

CB



Dulux Duralloy
Deep Ocean®
Satin

CB



Dulux Duralloy
Woodland Grey®
Matt

CB



Dulux Duralloy
APO Grey
Satin

NOTE: Not all Powdercoat Finishes apply to every Lockwood product. Refer to the notes at the end of this document for specific decorative finishes applicable per series.

CB Colorbond and the Colorbond colour names are registered trademarks of Bluescope Steel Limited



We recommend and use Dulux Powders

Disclaimer: Dulux, Duralloy, Anotec, Silver Kinetic, are registered trade marks of DuluxGroup (Australia) Pty Ltd. Monument, Night Sky, Dune, Woodland Grey, Jasper, Deep Ocean, Surfist, Pale Eucalypt, Paperbark, are registered trademarks of Bluescope Steel Limited. Product Colours displayed in this catalogue have been matched to indoor viewing and colour appearance may vary according to light source and medium and as such should be used as indicative only. As actual colour on the end product may vary, always confirm your colour choice with production line prepared samples from your ASSA ABLOY representative for final colour approval. For warranty terms and conditions on Lockwood Products and its finishes, please visit www.lockweb.com.au or call 1300WARRANTY



Dulux Powdercoat Finishes

For Powdercoat Finish sample order code:

FIN-SAMPLEPC specify the desired color from the images below when placing order.

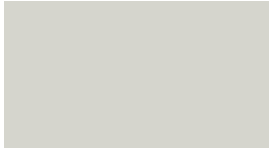

Dulux Duralloy
Surfmist®
Matt

CB

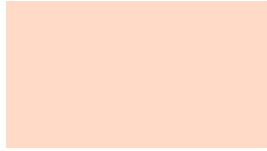

Dulux Duralloy
Anotec® Off White
Matt



Dulux Duralloy
Anotec® Mid Bronze
Matt



Dulux Duralloy
Dune®
Matt

CB



Dulux Duralloy
Anotec® Dark Grey
Matt

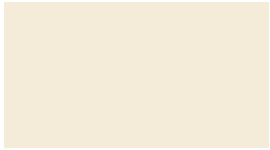

Dulux Duralloy
White Birch
Gloss



Dulux Duralloy
Stone Beige
Matt



Dulux Duralloy
Notre Dame
Gloss



Dulux Duralloy
Pale Eucalypt®
Satin

CB



Dulux Duralloy
Magnolia
Gloss



Dulux Duralloy
Doeskin
Satin



Dulux Duralloy
Paperbark®
Satin

CB



Dulux Duralloy
Classic Hawthorn Green
Gloss



Dulux Duralloy
Primrose
Gloss



Dulux Duralloy
Black (C/B Night Sky®)
Matt

CB

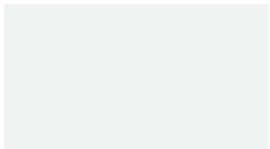

Dulux Duralloy
Pearl White
Gloss

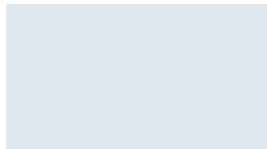

Dulux Duralloy
Bright White
Gloss



Dulux Precious
Mahogany Gloss Pearl



Dulux Surreal Effects
Black Gold
Gloss



Dulux Duralloy
Charcoal Lustre
Matt

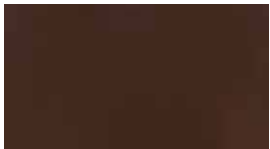

Dulux Alphatec
Ranch Brown
Satin

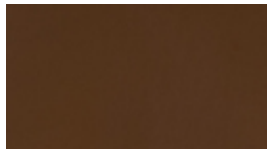

Dulux Duralloy
Coffee
Satin

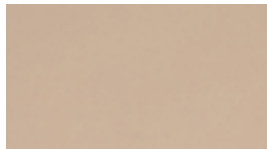

Dulux Duralloy
Pottery
Satin

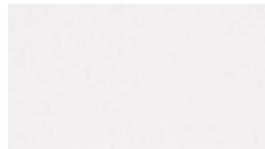

Dulux Duralloy
White Lustre
Matt

NOTE: Not all Powdercoat Finishes apply to every Lockwood product. Refer to the notes at the end of this document for specific decorative finishes applicable per series.

CB Colorbond and the Colorbond colour names are registered trademarks of Bluescope Steel Limited



We recommend and use Dulux Powders

Disclaimer: Dulux, Duralloy, Anotec, Silver Kinetic, are registered trade marks of DuluxGroup (Australia) Pty Ltd. Monument, Night Sky, Dune, Woodland Grey, Jasper, Deep Ocean, Surfist, Pale Eucalypt, Paperbark, are registered trademarks of Bluescope Steel Limited. Product Colours displayed in this catalogue have been matched to indoor viewing and colour appearance may vary according to light source and medium and as such should be used as indicative only. As actual colour on the end product may vary, always confirm your colour choice with production line prepared samples from your ASSA ABLOY representative for final colour approval. For warranty terms and conditions on Lockwood Products and its finishes, please visit www.lockweb.com.au or call 1300WARRANTY

Decorative Finishes Per Series

Powdercoat Finishes

Rose Door Handles: Robert Watson, 1220, 1420, 1360, 1370, 260, 260SQ

Plate Door Handles: 1800, 2800, 4800, 5800, 200, 202, 212, 224

Push/Pull Plates: 218/219, 206/207, 208/209, 214/215, 216/217, 184, 185

Metal Finishes

Use table below as a reference for the applicable finish to each Lockwood Series.

Refer to the series catalogue for specific detailed information.

Reference Table									
	Brass Series Rose Door Handles 1220, 1420, 1360, 1370	Brass Series Plate Door Handles 1800, 2800, 4800, 5800	Artefact Series Rose Door Handles 260	Artefact Series Rose Door Handles 260SQ	Artefact Series Plate Door Handles 200, 202,	Artefact Series Plate Door Handles 212, 224	Push/Pull Plate Series 184, 185	Push/Pull Plate Series 214/215, 216/217, 218/219	Push/Pull Plate Series 206/207, 208/209
Antique Copper (AC)	✓	✓	✓	✗	✓	✗	✓	✓	✗
Architectural Bronze Unlacquered (AU)	✓	✓	✓	✗	✓	✗	✓	✓	✗
Oil Rubbed Bronze (ORB)	✓	✓	✓	✗	✓	✗	✓	✓	✗
Aged Brass (AG)	✓	✓	✓	✗	✓	✗	✓	✓	✗
Architectural Bronze (AZ)	✓	✓	✓	✗	✓	✗	✓	✓	✗
Polished Brass (PB)	✓	✓	✓	✗	✓	✗	✓	✓	✗
Satin Brass (SB)	✓	✓	✓	✗	✓	✗	✓	✓	✗
Polished Brass Unlacquered (BU)	✓	✓	✓	✗	✓	✗	✓	✓	✗
Satin Brass Unlacquered (SBU)	✓	✓	✓	✗	✓	✗	✓	✓	✗
Satin Chrome Plating (SC)	✓	✓	✗	✗	✗	✗	✓	✗	✗
Chrome Plating (CP)	✓	✓	✗	✗	✗	✗	✓	✗	✗
Stainless Steel (SS)	✗	✗	✓	✓	✓	✓	✗	✓	✓
Polished Stainless Steel (PS)	✗	✗	✓	✗	✓	✓	✗	✓	✓
Marine Grade Stainless Steel (MG)	✗	✗	✓	✗	✓	✓	✗	✓	✓
Natural Anodised Aluminium (NT)	✗	✗	✓	✗	✓	✓	✗	✗	✗

Disclaimer: Product Colours displayed in this catalogue have been matched to indoor viewing and colour appearance may vary according to light source and medium and as such should be used as indicative only. As actual colour on the end product may vary, always confirm your colour choice with production line prepared samples from your ASSA ABLOY representative for final colour approval. For warranty terms and conditions on Lockwood Products and its finishes, please visit www.lockweb.com.au or call 1300WARRANTY



ASSA ABLOY

Lockwood is the leading brand in the Australian locking industry. With an established reputation for high quality products, this iconic brand provides a wide range of locking solutions to residential housing, commercial, semi-commercial, building and industrial application markets. Lockwood is supported by an extensive distribution and after-sales support network. Our customers include retailers, architects, trade and industrial personnel, locksmiths and security dealers.

ASSA ABLOY is the global leader in door opening solutions, dedicated to satisfying end-user needs for security, safety and convenience.

ASSA ABLOY is represented in all major regions, in both mature and emerging markets, with leading positions in Australia, Europe and North America.

**25YEAR
MECHANICAL
WARRANTY**

The Lockwood 25 Year Mechanical Warranty

Our belief that we manufacture the finest premium products available in today's market place is backed by the Lockwood 25 Year Mechanical Warranty, ensuring that Lockwood continues to keep Australians safe by delivering security and peace of mind.

For warranty terms and conditions, please visit www.lockweb.com.au or call **1300WARRANTY**

ASSA ABLOY Opening Solutions Australia
235 Huntingdale Road
Oakleigh, Victoria, 3166
Australia

1300 LOCK UP (1300 562 587)
lockweb.com.au

ASSA ABLOY New Zealand Ltd
6 Armstrong Road
Albany, Auckland, 0632
New Zealand

nzsales@assaabloy.com
Telephone +64 9415 7111
assaabloyopeningsolutions.nz

Disclaimer

Whilst every effort has been made to ensure that the information (including product images and drawings) contained in this brochure is accurate at the time of publication, ASSA ABLOY Australia Pty Limited ("ASSA ABLOY") recommends that you consult ASSA ABLOY or its agents prior to placing an order to ascertain current information on specific products, as ASSA ABLOY reserves the right to make changes without notice. ASSA ABLOY will not be liable for any injury, loss or damage whatsoever, arising from any errors or omissions in the information contained in the brochure or arising from the use or application of the information contained herein. © 2019 copyright by ASSA ABLOY All rights reserved

