

8800 Series Floor Closer



Description

The Lockwood 8800 Series Floor Closers are designed to provide door control on manually operated double action doors in a wide range of commercial applications. The mounting kit provided with the Lockwood 8800 Series will suit glass, timber and aluminium frame door construction as standard.

Features

- 2, 3 and 4 power
- Non hold-open
- 90° & 105° hold-open
- Adjustable pivot inserts
- Pivot door sets
- Lockwood guaranteed

Additional Features

Interchangeable extended pivot inserts ranging from +5 to +35mm. This range will accommodate applications such as threshold, carpeted floors or situations where additional clearance between the door and floor are required.

Universal off set pivot sets for flush closing single action door applications (SP844-30).

Product Details

Door Adjustment The Lockwood 8800 is positionally adjustable for a height of 4mm, a width of 10mm and a length of 9mm.

Door Control Two independent adjustment valves provide full hydraulic control from 130° to 15° of closing and 15° to 0° of latching.

Door Frame Type Timber/aluminium/steel

Door Thickness Minimum for timber 32 mm

Door Weight Up to 120kg as standard

Door Width Up to 1150mm (refer to selection procedure)

Finishes Stainless Steel (SSS)
Gold (GLD)
Polished Stainless Steel (PSS)
Other finishes on application

Hold-Open Available in both non hold-open and hold-open versions. Mechanical hold-open 90° and 105° in separate units.

Pivot Door Sets

Suitable for door applications where a free swing pivot door is required. Consists of retractable top pivot set with heavy duty bottom pivot and strap. Suitable for aluminium, glass and timber doors.

*** For all external applications or where the floor spring will be exposed to moisture, its recommended that a silicone based compound is used to prevent corrosion.***

8800 Series Floor Closer

Limiting Dimensions

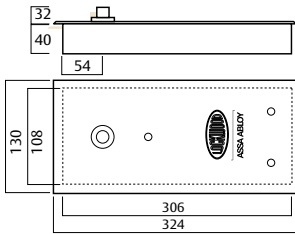

Bottom Strap

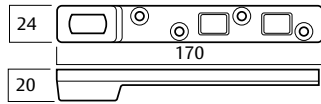

Top Pivot

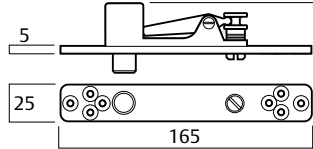

Top Pivot Housing

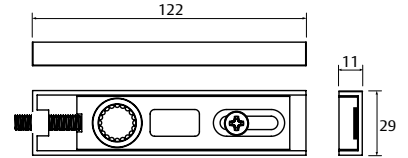

8800 Series Product Range

Non Hold-Open

Part Numbers Description

8842NSSS	Size 2 Standard Floor Spring Non Hold-Open
8843NSSS	Size 3 Standard Floor Spring Non Hold-Open
8844NSSS	Size 4 Standard Floor Spring Non Hold-Open

105° Hold-Open

Part Numbers Description

8842H105SSS	Size 2 Standard Floor Spring 105° Hold-Open
8843H105SSS	Size 3 Standard Floor Spring 105° Hold-Open
8844H105SSS	Size 4 Standard Floor Spring 105° Hold-Open

90° Hold-Open

Part Numbers Description

8842H90SSS	Size 2 Standard Floor Spring 90° Hold-Open
8843H90SSS	Size 3 Standard Floor Spring 90° Hold-Open
8844H90SSS	Size 4 Standard Floor Spring 90° Hold-Open

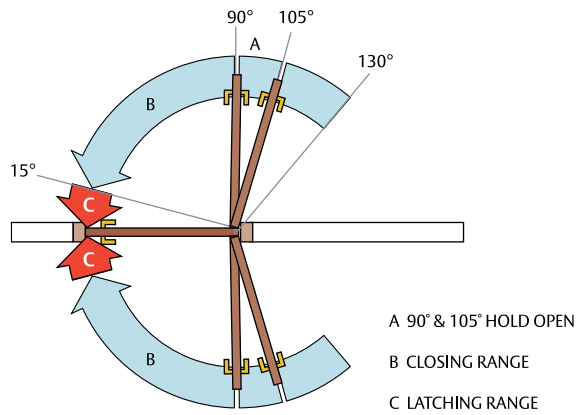

8800 Series Floor Closer

Size Selection Chart

Spring Size	Door width	Max Door Weight	Closing Torque
2	850 mm	120 kg	20 Nm
3	950 mm	120 kg	27 Nm
4	1100 mm	120 kg	39 Nm

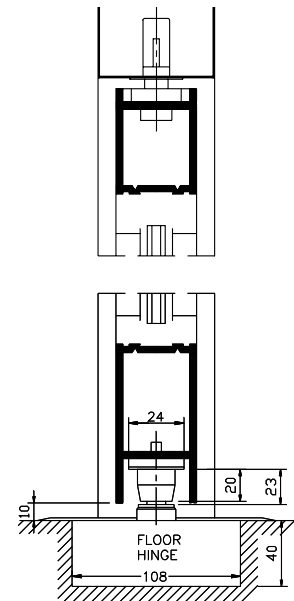
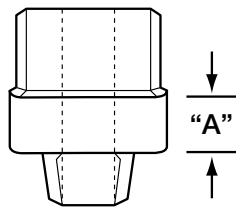

Extended Spindle Range

	Standard Inset	+5mm	+10mm	+15mm	+20mm	+25mm	+30mm
Part Number	SP884-60	SP884-60-5	SP884-60-10	SP884-60-15	SP884-60-20	SP884-60-25	SP884-60-25
3° Left Hand Offset							
Part Number	SP884-60LH	SP884-60-5LH	SP884-60-5LH	SP884-60-15LH	SP884-60-20LH	SP884-60-25LH	SP884-60-30LH
3° Right Hand Offset							
Part Number	SP884-60RH	SP884-60-5RH	SP884-60-10RH	SP884-60-15RH	SP884-60-20RH	SP884-60-25RH	SP884-60-30RH

8800 Series Floor Closer

Pivot Door Set Product Range

Part Numbers	Description
985-300	Aluminium or Timber Door Pivot Kit
985-350	Glass Door Pivot Kit
985-400	Heavy Door Pivot Kit

Description

Suitable for door applications where a free swing pivot door is required. Consists of retractable top pivot set with heavy duty bottom pivot and strap. Suitable for aluminium, timber and glass doors.

Aluminium or Timber Door Pivot Kit

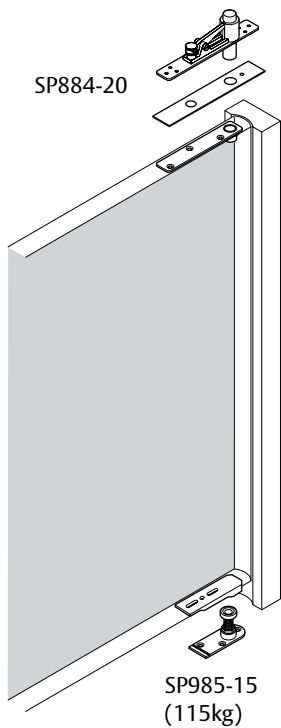

985-300

Glass Door Pivot Kit

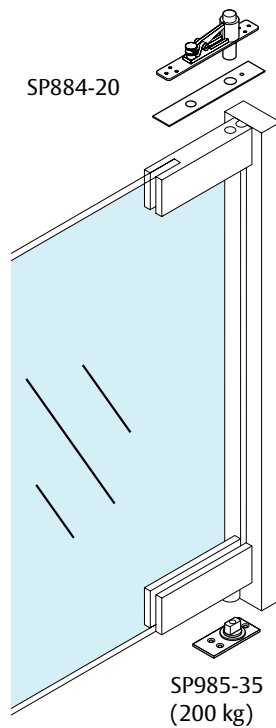

985-350

Heavy Door Pivot Kit

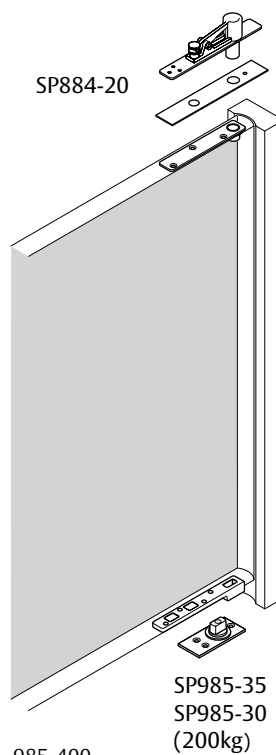

985-400



ASSA ABLOY

Lockwood is the leading brand in the Australian locking industry. With an established reputation for high quality products, this iconic brand provides a wide range of locking solutions to residential housing, commercial building and industrial application markets. Lockwood is supported by an extensive distribution and after-sales support network. Our customers include retailers, architects, trade and industrial personnel, locksmiths and security dealers.

ASSA ABLOY is the global leader in door opening solutions, dedicated to satisfying end-user needs for security, safety and convenience.

ASSA ABLOY is represented in all major regions, in both mature and emerging markets, with leading positions in Australia, Europe and North America.

**25YEAR
MECHANICAL
WARRANTY**

The Lockwood 25 Year Mechanical Warranty

Our belief that we manufacture the finest premium products available in today's market place is backed by the Lockwood 25 Year Mechanical Warranty, ensuring that Lockwood continues to keep Australians safe by delivering security and peace of mind.

For warranty terms and conditions, please visit www.lockweb.com.au or call **1300WARRANTY**

ASSA ABLOY Australia Pty Ltd
235 Huntingdale Road
Oakleigh, Victoria, 3166
Australia

1300 LOCK UP (1300 562 587)
lockweb.com.au

ASSA ABLOY New Zealand Ltd
6 Armstrong Road
Albany, Auckland, 0632
New Zealand

info.nz@assaabloy.com
Telephone +64 9415 7111
assaabloy.co.nz



MCT1244