

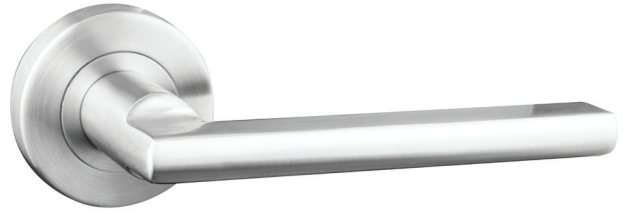

# 7000 Series



The Schlage 7000 Series door furniture is a competitively priced premium quality range, available in a wide variety of lever profiles. These contemporary levers are designed with distinctive European influence. Blending form with function, this furniture will allow you to express your individuality with lasting integrity. Beautifully designed down to the last detail, this series is manufactured from high quality 304 grade stainless steel for high performance and increased durability.

This range is finished in a warm satin stainless steel tone to complement other finishes and appliances throughout your project.

## Features

- Constructed of quality components with solid stainless steel levers and outer roses
- Available in privacy push-button for quick installation and ease of use
- The 7000 Series is suitable for use on approved fire core door assemblies when used with fire rated mortice locks or latches
- Concealed through fixing bolts ensure secure assembly of lever furniture onto doors for lasting performance and aesthetic appeal



# Specification guide

Function	Lever	Finish
Latch furniture ..... 7000	Albo ..... 713	Satin stainless steel ..... SSS
Half set ..... 7001	Alpha ..... 715	Other finishes available on request
Dummy trim ..... 7002	Angelo ..... 714	
Passage set ..... 7005	Costa ..... 717	
Privacy set ..... 7006	Stefano ..... 722	
	Telo ..... 716	

- 1. Function**  
 Select the desired function e.g. Passage set ..... **7005/**
- 2. Lever**  
 Add the required lever design e.g. Alpha #715 ..... **7005/715**
- 3. Finish**  
 Add the desired finish e.g. Satin stainless steel ..... **7005/715SSS**

## Finishes

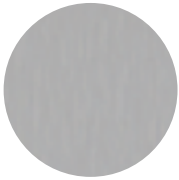

**SSS**

Satin Stainless Steel

## Testing and Compliance



**Fire Rating:**

Successfully tested on fire door assemblies in accordance with AS1905 Part1: Fire resistance doorsets. Check with fire door manufacturer prior to installation.



**Accessibility:**

Compliant to the AS 1428:1-2009 Design for Access and Mobility

**Caution:**

When door closers are installed and adjusted to meet reduced opening force requirements, there may be insufficient power to reliably close and latch the door, depending on prevailing operating conditions.

**Note:**

In areas of high wind pressure and/or air conditioning pressures, the LCN Automatic Door Operators are recommended.

# 7000 Series solid stainless steel lever designs

**Albo #713**

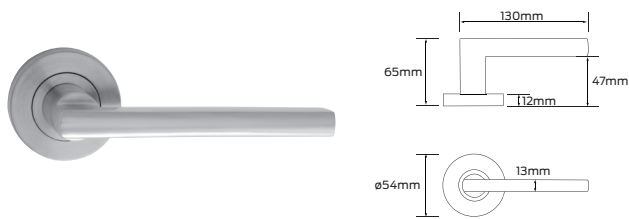

**Alpha #715** 

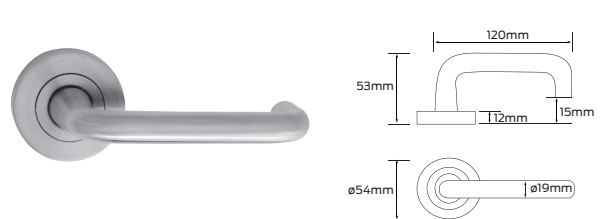

**Angelo #714**

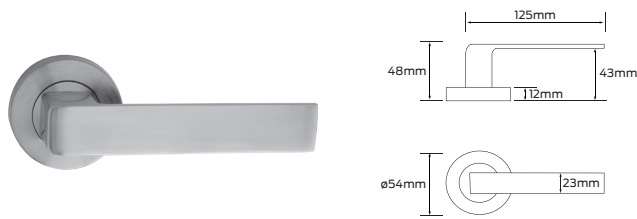

**Costa #717** 

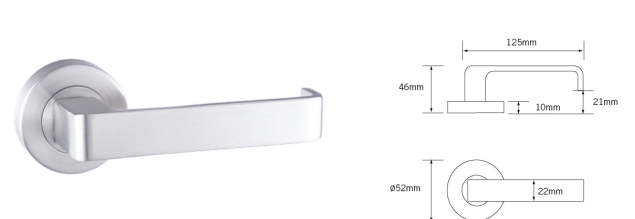



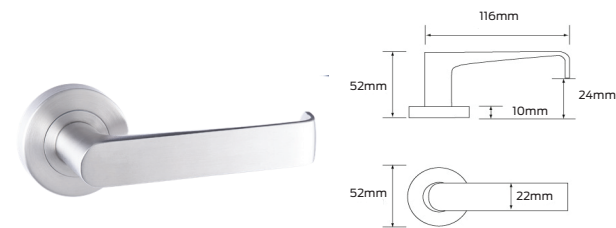



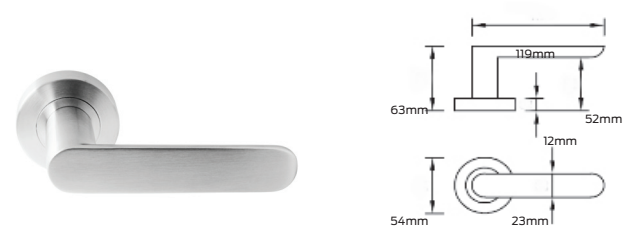

**Telo #716** 



**Stefano #722**



## Legend

Turn snib		LED	
Cylinder hole		Anti-ligature knob	
Emergency button		Indicating	
Accessible turn		Denotes handed product	

# Handing guide

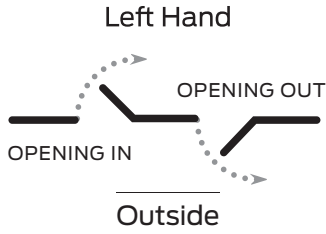
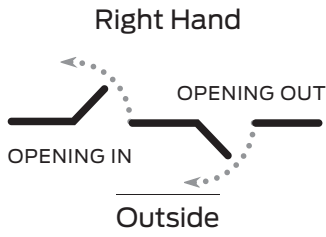

## Specifications

<b>Door type</b>	Timber or metal
<b>Door thickness</b>	Latch furniture 35mm to 50mm Passage set 35mm to 50mm Privacy set 32mm to 45mm
<b>Backset</b>	60mm
<b>Spindle size</b>	7.6mm
<b>Compatible locks/latches</b>	Tubular latches, ME Series mortice locks 990MF Series mortice locks
<b>Fixing</b>	Concealed through fixings
<b>Materials</b>	Solid stainless steel handles and outer ring, die cast inner roses
<b>Finish</b>	Satin stainless steel
<b>Warranty</b>	10 year mechanical and finish for residential and light commercial use

## Functions

**Outside Inside**

### 7000 - Lock/Latch furniture

Two levers to be used with a latch, mortice lock or converted to dummy trim with fixing kit (Supplied with a pair of levers, and fixings only, to be used with optional mortice locks or latches, can be converted to dummy trims using optional fixing kits)



### 7005 - Passage set (60mm backset)

Both levers always unlocked (Supplied complete with a passage tubular latch, strike plate and all fixings)



### 7006 - Privacy set (60mm backset)

Push-button locks outside lever (outside emergency release). Inside lever unlocks door (Supplied complete with a privacy tubular latch, strike plate, and all fixings)



### 7001 - Half set

Active lever for use with a latch or converted to dummy trim with fixing kit



### 7002 - Dummy trim

Inactive lever which is used as a door pull or matching trim



## Passage door preparation

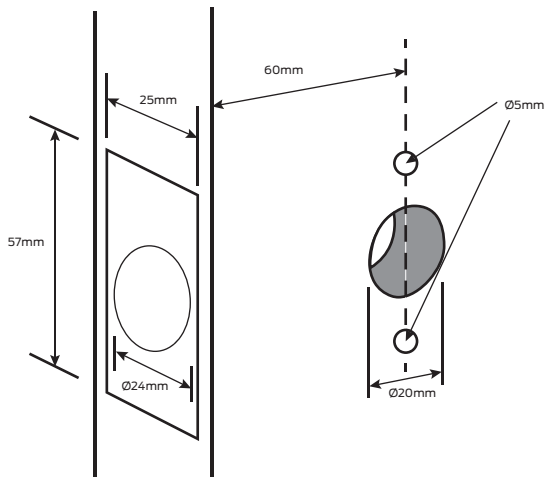

## Privacy door preparation

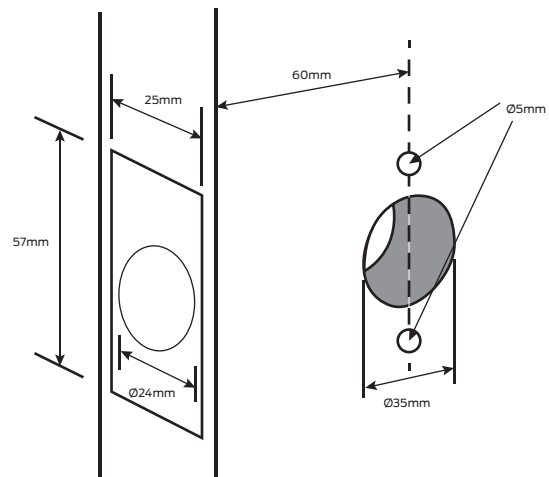

# 7000 Series escutcheons

**Cylinder #7008**

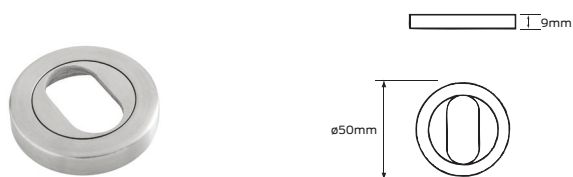

**Euro profile cylinder #7012**

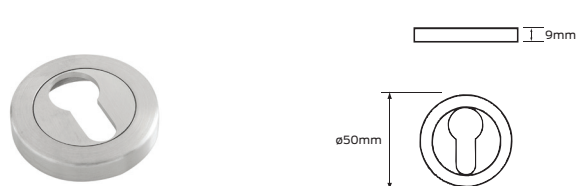

**Emergency release #7009**



**Indicating emergency release #7014**



**Turn #7007**



**Indicating turn #7013**



**Accessible turn #7054**



Depicted in RH

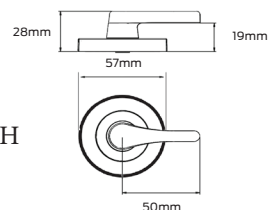

**Indicating accessible turn #7054IND**



Depicted in RH

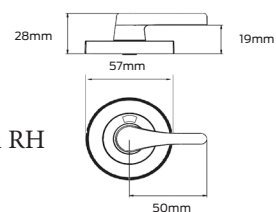

## Legend

Turn snib		LED	
Cylinder hole		Anti-ligature knob	
Emergency button		Indicating	
Accessible turn		Denotes handed product	

# 7000 Series accessories

## Passage latch

60mm backset  
**Finishes:** Polished stainless steel, satin stainless steel

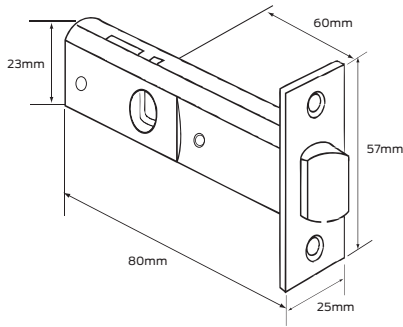

## Privacy latch

60mm backset  
**Finishes:** Polished stainless steel, satin stainless steel

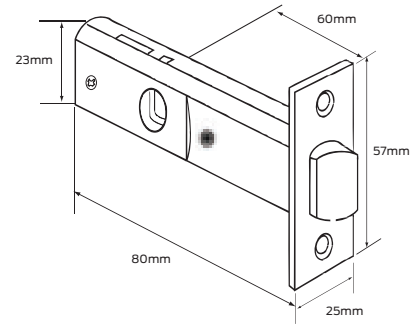

## Dummy trim fixing kit

Allows conversion of lever furniture to dummy trim function.  
One kit required per lever

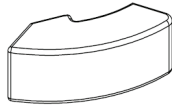

## Rose caps

Available to mix and match finishes with levers  
**Finish:** Satin stainless steel

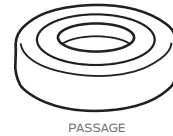

## Universal rebate kit

**Finish:** Satin stainless steel

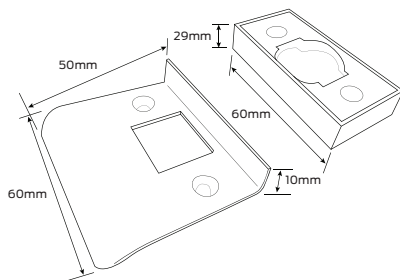

## Emergency turn set

Turn escutcheon, emergency release escutcheon and deadbolt  
**Finish:** Satin stainless steel

