

# Hinges



## General Information

The 100 Series Architectural Hinges are designed to provide an effective solution to hanging doors where there is a need for high grade, architectural quality hinges. These hinges are suitable for use on aluminium or steel glazed doors and solid core timber doors. Many of them can also be used on fire doors.

## Lockwood Warranty

Selection of the appropriate hinge for the application is critical to ensure the longevity of the hinge and customer satisfaction. The Lockwood warranty is only applicable for hinges that are installed in accordance with the recommendations of the hinge selection table on page 15.

## Hinge Height and Width

When reading dimensions, the first figure always indicates the hinge height and the second indicates the width, eg. 100 mm x 75 mm. The door thickness and door jamb width (also trim size if applicable) determine the width of the hinge required. The width is measured across the leaves when the hinge is fully opened as shown in Diagram 1.

## Security

Fixed pin hinges should be used on exterior doors or doors opening out. Also, doors made of particle should have a capped tongue edge strip framing the door, so that hinges can be screwed into solid material.

## Hinge Maintenance

The maintenance free hinges in the Lockwood 100 Series Architectural Hinge range are the Severe Duty Butt Hinges with the phosphorous bronze bushes (Part numbers LW10000SDSSS and LW10075SDSSS). These Severe Duty Butt Hinges are self-lubricating.

The remainder of the Lockwood 100 Series Architectural Hinge range are greased hinges which are fit for purpose in many applications. The grease is fundamental to the durability of the product. However, with use it is possible for some grease to seep out onto the surface of the hinge and if left unchecked can lead to door, frame, wall or floor staining in extreme cases.

To prevent this from happening, greased hinges should be monitored and cleaned externally during their life.

In environments where hygiene is critical such as hospitals and food facilities or where hinge maintenance is not a priority, the Lockwood Severe Duty Butt Hinges are highly recommended.

## Finishes

Satin Stainless Steel **SSS**  
Polished Stainless Steel **PSS**  
Satin Chrome **SC**

## Number of Hinges Per Door

For doors up to 2,100mm high, at least 3 hinges

should be used if the Adjusted Door Weight is over 20kg. If the Adjusted Door Weight is 20kg or less, 2 hinges can be used. For doors over 2,100mm high, at least 4 hinges should be used. The method for establishing the Adjusted Door Weight is given on Page 13.

## Fire Rated

Please refer to the Hinge Selection Table on page 13 for hinge fire rating information.

## Door Stops

It is recommended a door stop be installed to ensure that the door has a positive backstop at the degree of opening selected. It is essential to use a door stop where design factors of the building necessitate opening out of external doors and no windbreak is provided.

## Hinge Selection

Prior to selecting a suitable hinge, the Adjusted Door Weight needs to be calculated. The Adjusted Door Weight takes into account the extra stresses that door closers and wider doors place on the hinges and is used to select the appropriate hinge from the table below. Please refer to Page 15 for calculation of the Adjusted Door Weight.

# Hinges

## Calculating the Adjusted Door Weight.

Establish the weight of door including all door furniture, metal plates and windows. If you have a door closer, add 20% to the door weight.

If the door closer has back-check, add 75% to the door weight, instead of the 20% above.

For door width over 950mm:

951mm to 1050mm, add 10% to door weight.

1051mm to 1150mm, add 20% to door weight.

1151mm to 1250mm, add 30% to door weight.

Therefore, Adjusted Door Weight = (total weight of the door) + (% for door closer/back-check) + (% for any width over 950mm) Please refer to [lockweb.com.au/hinge-calc](http://lockweb.com.au/hinge-calc) for the online Hinge Adjusted Weight Calculator.

## Hinge Selection Table

This Hinge Selection Table has been developed to assist in hinge selection for doors in commercial applications where frequent use is anticipated (eg hospitals, schools, universities, offices and public buildings). In applications where it is reasonable to anticipate less frequent use

(eg apartment entry doors) the maximum adjusted door weight becomes less relevant and as such the complete range of Lockwood hinges can be relied on to provide trouble free service.

Hinge Part Number	Hinge Size (mm)	Description	*Finish	Type	*Material	Maximum Adjusted Door Weight (kg)	Fire Rating				
LW10075RLSSS	100x75x2.5	Right Hand Lift Off	SSS	Lift Off Hinge	SS	50	None				
LW10075LLSSS		Left Hand Lift Off									
LW10000BBPSS	100x100x2.5	Ball Bearing	PSS	Butt Hinge	SS	60	These Lockwood hinges have been successfully tested up to four hours (depending on type of doorset) on fire door assemblies in accordance with Australian Standard AS 1905.1-2005, Part 1: Fire Resistant Doorsets.				
LW10000BBS	100x100x2.5	Ball Bearing	SSS								
LW10075BBPSS	100x75x2.5	Ball Bearing	PSS								
LW10075BBS	100x75x2.5	Ball Bearing	SSS								
LW10000FPPSS	100x100x2.5	Fixed Pin	PSS								
LW10000FPSS	100x100x2.5	Fixed Pin	SSS								
LW10075FPPSS	100x75x2.5	Fixed Pin	PSS								
LW10075FPSS	100x75x2.5	Fixed Pin	SSS								
LW10000LPPSS	100x100x2.5	Loose Pin	PSS								
LW10000LPSS	100x100x2.5	Loose Pin	SSS								
LW10075LPPSS	100x75x2.5	Loose Pin	PSS								
LW10075LPSS	100x75x2.5	Loose Pin	SSS								
LW10000BBSC	100x100x2.5	Ball Bearing	SC					Butt Hinge	MS	60	These Lockwood hinges have been successfully tested up to four hours (depending on type of doorset) on fire door assemblies in accordance with Australian Standard AS 1905.1-2005, Part 1: Fire Resistant Doorsets.
LW10075BBSC	100x75x2.5	Ball Bearing									
LW10000FPSC	100x100x2.5	Fixed Pin									
LW10000LPSC	100x100x2.5	Loose Pin									
LW10075LPSC	100x75x2.5	Loose Pin									
LW10000BBHDSS	100x100x3.0	Heavy Duty	SSS	Heavy Duty Butt Hinge	SS	70	These Lockwood hinges have been successfully tested up to four hours (depending on type of doorset) on fire door assemblies in accordance with Australian Standard AS 1905.1-2005, Part 1: Fire Resistant Doorsets.				
LW10000SDSSS	100x100x3.0	Severe Duty	SSS	Severe Duty Butt Hinge	SS	120					
LW10075SDSSS	100x75x3.0										

\*Legend: SS=Stainless Steel

MS=Mild Steel

SSS=Satin Stainless Steel finish

PSS=Polished Stainless Steel finish

SC=Satin Chrome finish

# Hinges

## Typical Applications

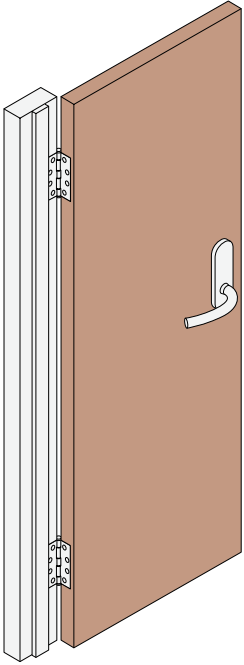

Typical internal doors

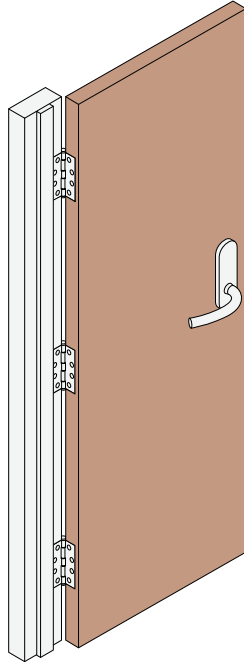

Typical external or high usage doors

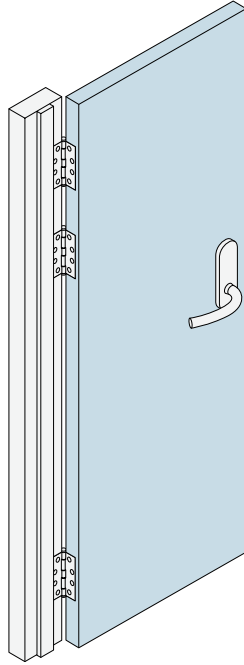

Typical heavy doors

## Hinge Throw Selection

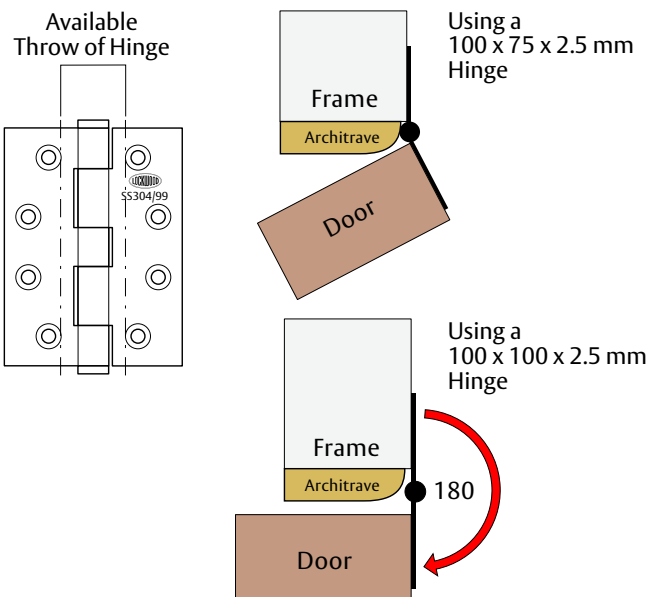

## Diagram 1

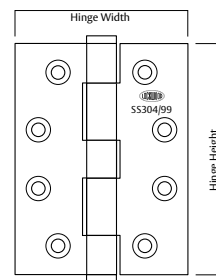

# Hinges

## Stainless Steel Ball Bearing Hinges

### Satin Stainless Steel/Polished Stainless Steel/Button Tipped Hinge

Suitable for interior/exterior doors where a durable, architectural ball bearing hinge is required, or when being used in conjunction with a door closer.

- Two ball bearings
- Manufactured from 304 stainless steel
- Available fixed pin only
- Metric sizes
- Standard metric hole pattern

**Sizes:** 100 x 75 x 2.5 mm,  
100 x 100 x 2.5 mm  
and 100 x 100 x 3.0mm

**Thickness:** 2.5 mm and 3.0mm

**Screws:** Stainless Steel Screws  
supplied with each hinge 10  
Gauge x 30mm Wood Screws  
x 8 M5 12mm Metal Thread  
Screws x 4

**Pack Size:** 30 (and 18 for the 3.0mm  
thick hinge)

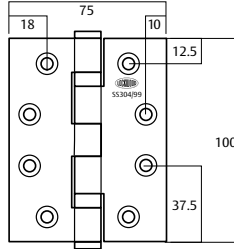

LW10075BBPSS

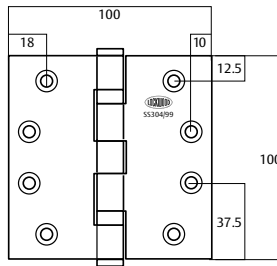

LW10075BBSSS



## Stainless Steel Hinges

### Satin Stainless Steel/Polished Stainless Steel/Button Tipped Hinge

Suitable for interior/exterior doors where a durable, architectural hinge is required.

- Manufactured from 304 stainless steel
- Available fixed and loose pin
- Metric sizes
- Standard metric hole pattern

**Sizes:** 100 x 75 x 2.5 mm  
and 100 x 100 x 2.5 mm

**Thickness:** 2.5 mm

**Screws:** Stainless Steel Screws  
supplied with each hinge  
10 Gauge x 30mm Wood  
Screws x 8 M5 x 12mm Metal  
Thread Screws x 4

**Pack Size:** 30

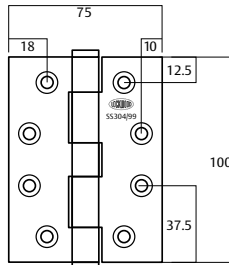

LW10075LPSSS

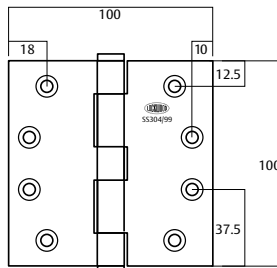

LW10000FPPSS



# Hinges

## Mild Steel Ball Bearing Hinges

Suitable for general purpose interior/ exterior doors where a standard ball bearing hinge is required or when being used in conjunction with a door closer.

- Manufactured from high grade steel
- Available fixed pin only
- Metric sizes
- Standard metric hole pattern

**Sizes:** 100 x 75 x 2.5 mm  
and 100 x 100 x 2.5 mm

**Thickness:** 2.5 mm

**Screws:** Zinc Plated Mild Steel Screws  
supplied with each hinge  
10 Gauge x 30mm Wood  
Screws x 8 M5 x 12mm Metal  
Thread Screws x 4

**Pack Size:** 30

**Finish:** Satin Chrome

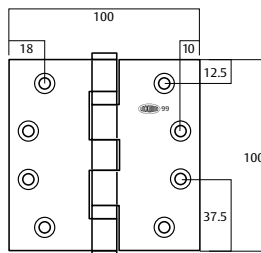
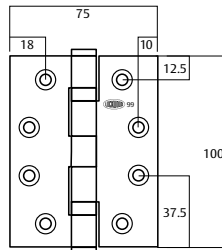

LW10000BBSC



## Mild Steel Hinges

Suitable for general purpose interior/ exterior doors where a standard hinge is required.

- Manufactured from high grade steel
- Available fixed and loose pin
- Metric sizes
- Standard metric hole pattern

**Sizes:** 100 x 75 x 2.5 mm  
and 100 x 100 x 2.5 mm

**Thickness:** 2.5 mm

**Screws:** Zinc Plated Mild Steel Screws  
supplied with each hinge  
10 Gauge x 30mm Wood  
Screws x 8 M5 x 12mm Metal  
Thread Screws x 4

**Pack Size:** 30

**Finish:** Satin Chrome

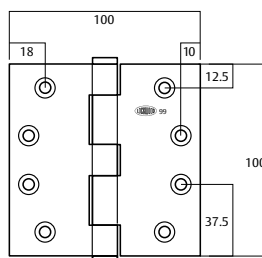
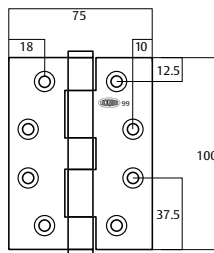

LW10000LPSC



# Hinges

## Stainless Steel Bushed Bearing Hinges (Severe Duty)

High performance bushed bearing butt hinges suitable for severe duty applications.

- Manufactured from 304 stainless steel
- Available in fixed pin only
- Metric sizes

**Sizes:** 100 x 100 x 3.0mm  
and 100 x 75 x 3.0mm

**Screws:** Stainless Steel Screws supplied with each hinge. 10 Gauge x 30mm Wood Screws x 8  
M5 x 14mm Metal Thread Screws x 4

**Pack Size:** 36

**Finish:** Satin Stainless Steel

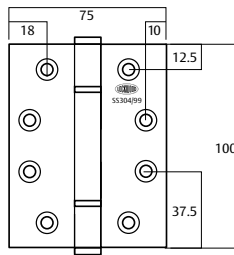

LW10075SDSSS

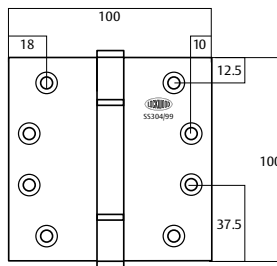

## Lift Off Stainless Steel Hinges

Suitable for where a door may need to be lifted off after installation

- Available in left and right hand versions
- Manufactured from 304 stainless steel
- Metric sizes

**Sizes:** 100 x 75 x 2.5mm

**Screws:** Stainless Steel Screws supplied with each hinge. 10 Gauge x 30mm Wood Screws x 8  
M5 x 12mm Metal Thread Screws x 4

**Pack Size:** 30

**Finish:** Satin Stainless Steel

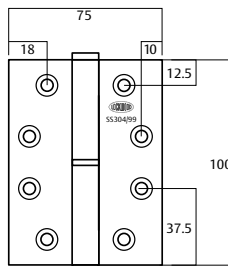

LW10075LLSSS



# Hinges

## Fast Fix Stainless Steel Ball Bearing Hinge

Ideal for general purpose interior/ exterior use where aluminium frames/ doors are used.

- Two ball bearings
- Manufactured from 304 stainless steel
- Available fixed pin only
- Metric sizes

**Sizes:** 100 x 70 x 2.5 mm

**Thickness:** 2.5 mm

**Screws:** Stainless Steel Screws supplied with each hinge  
 10 Gauge x 30mm Wood Screws x 6  
 M5 x 12mm Metal Thread Screws x 6

**Pack Size:** 30

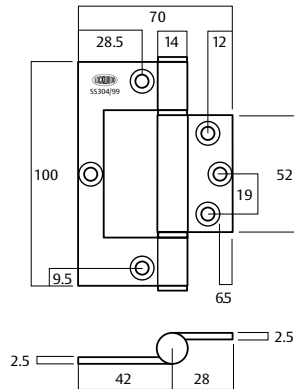

LW10070BBFFSS



## Fast Fix Stainless Steel Ball Bearing Hinge

Ideal for general purpose interior/ exterior use where timber frames/ doors are used.

- Two ball bearings
- Manufactured from 304 stainless steel
- Available fixed pin only
- Metric sizes

**Sizes:** 100 x 70 x 2.5 mm

**Thickness:** 2.5 mm

**Screws:** Stainless Steel Screws supplied with each hinge  
 10 Gauge x 32mm Wood Screws x 7  
 M5 x 12mm Metal Thread Screws x 7

**Pack Size:** 30

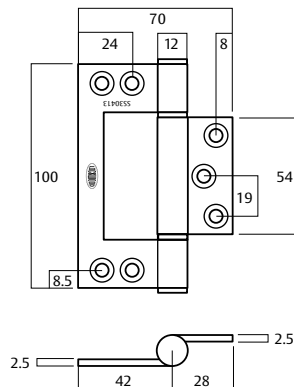

LW10070BBFFSSA

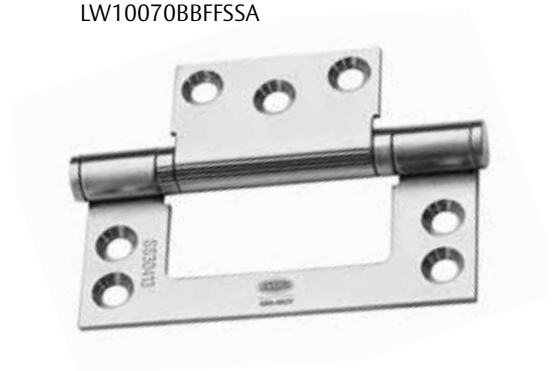

# Hinges

## AH130 Fast Fix Aluminium Hinge

The Lockwood AH130 is a heavy duty fast fix hinge with face fix flanges to suit aluminium commercial door applications.

Heavy duty, bi-directional face fix locator flanges allows for faster installation.

### Installation Guide

- Minimum door thickness 40mm
- Up to 2100 high x 900 x 100kg  
– 3 hinges
- Up to 2400 high x 900 x 100kg  
– 4 hinges

### Fixing

- Heavy duty bi-directional fixing
- Face fix locator flange allows for faster installation
- Supplied with 11 of 10G x 12mm, 304SS undercut countersunk self tapping (AB) Phillip drive screws

### Technical Specification

- Hinge: 6063-T6 alloy
- Hinge Pin: 6mm 304 grade Stainless Steel
- Nylon bushes
- Squareline heavy duty knuckles
- Interference pressed fit aluminium end caps

Overall dimensions

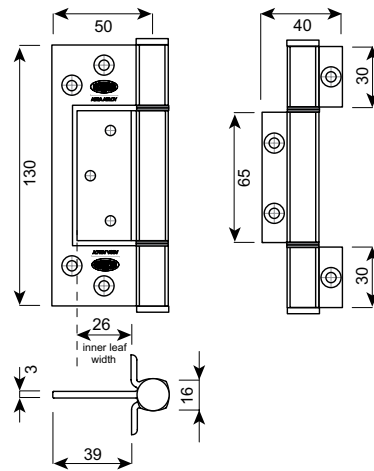

AH130CAN



Screw hole fixing dimensions

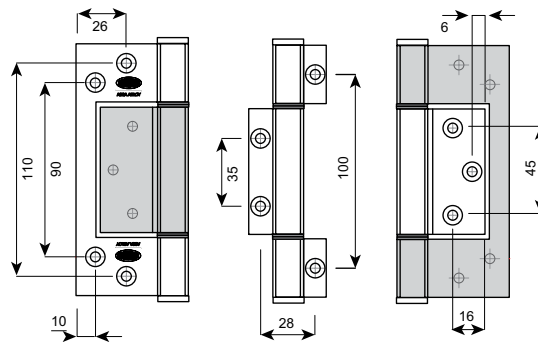

## AH130 Fast Fix Aluminium Hinge

Finish	Packaging	Part Number
Clear Anodised	Trade	AH130CAN
Black Powdercoat	Trade	AH130BLK
White Powdercoat	Trade	AH130WH
Silver Powdercoat	Trade	AH130SIL





**ASSA ABLOY**

**Lockwood** is the leading brand in the Australian locking industry. With an established reputation for high quality products, this iconic brand provides a wide range of locking solutions to residential housing, commercial, semi-commercial, building and industrial application markets. Lockwood is supported by an extensive distribution and after-sales support network. Our customers include retailers, architects, trade and industrial personnel, locksmiths and security dealers.

**ASSA ABLOY** is the global leader in door opening solutions, dedicated to satisfying end-user needs for security, safety and convenience.

**ASSA ABLOY** is represented in all major regions, in both mature and emerging markets, with leading positions in Australia, Europe and North America.

**25YEAR  
MECHANICAL  
WARRANTY**

### **The Lockwood 25 Year Mechanical Warranty**

Our belief that we manufacture the finest premium products available in today's market place is backed by the Lockwood 25 Year Mechanical Warranty, ensuring that Lockwood continues to keep Australians safe by delivering security and peace of mind.

For warranty terms and conditions, please visit [www.lockweb.com.au](http://www.lockweb.com.au) or call **1300WARRANTY**

**ASSA ABLOY Australia Pty Ltd**  
235 Huntingdale Road  
Oakleigh, Victoria, 3166  
Australia

**1300 LOCK UP (1300 562 587)**  
[lockweb.com.au](http://lockweb.com.au)

**ASSA ABLOY New Zealand Ltd**  
6 Armstrong Road  
Albany, Auckland, 0632  
New Zealand

[info.nz@assaabloy.com](mailto:info.nz@assaabloy.com)  
Telephone +64 9415 7111  
[assaabloy.co.nz](http://assaabloy.co.nz)

#### **Disclaimer**

Whilst every effort has been made to ensure that the information (including product images and drawings) contained in this brochure is accurate at the time of publication, ASSA ABLOY Australia Pty Limited ("ASSA ABLOY") recommends that you consult ASSA ABLOY or its agents prior to placing an order to ascertain current information on specific products, as ASSA ABLOY reserves the right to make changes without notice. ASSA ABLOY will not be liable for any injury, loss or damage whatsoever, arising from any errors or omissions in the information contained in the brochure or arising from the use or application of the information contained herein. © 2018 copyright by ASSA ABLOY All rights reserved

