

Grab rails and shower support rails are installed to provide safe support for persons who require assistance in toilets and bathrooms. When correctly installed, the grab rail is required to withstand a minimum of 1100 Newtons of force as per Australian Standard AS 1428.1.

Solid walls do not present a problem e.g. concrete or brick walls. If a building is constructed with either a metal frame (metal walls to be reinforced with timber) or timber frame, it is essential to know the dimensions of studs and noggins and the space between them.

**TOGGLE BOLTS FIXED INTO TILES, PLASTER BOARD OR OTHER WATER PROOF WALLS ARE NOT SATISFACTORY OR SAFE.** Grab rails must be fitted to a solid wall or other firm surface and installed by a qualified trades person.

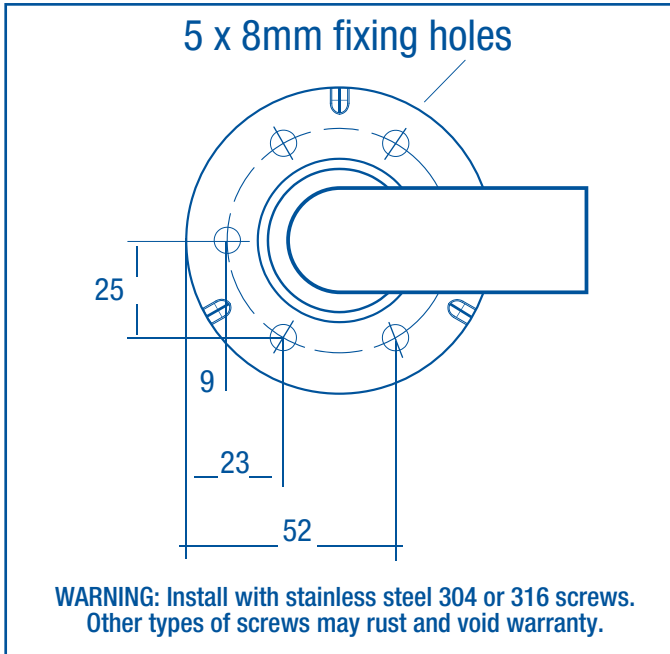

**Notes**

- At least 2 fixing points must be used on each flange.
- Caulking may be used around flanges to prevent moisture seepage.
- Clean with mild soap and rinse with warm water.
- Avoid prolonged exposure to any solutions containing chlorides or acids.

**Our Promise**

Con-Serv Corporation Australia Pty Ltd warrants all of its products (as below) with a Limited Lifetime Warranty on all mechanical parts from manufacturing defects in materials and workmanship under normal use in a domestic installation for as long as the original purchaser owns their home into which the particular product(s) was/were installed. A five year warranty (also on the terms below) will apply to commercial installations, irrespective of ownership. Con-Serv will repair or replace defective items correctly installed as per the Con-Serv installation instructions. Con-Serv will not be liable for defects arising through normal wear and tear. Item(s) must be returned with proof of purchase to Con-Serv at 17 Glentanna Street, Kedron, Queensland 4031. We will attend to your warranty claim after we make appropriate investigations. Contact our Service Manager during normal office hours on 1300 467 322 or at our email address of [warranty@con-serv.com.au](mailto:warranty@con-serv.com.au). If a warranty claim is accepted, Con-Serv will bear the reasonable costs of the return of the defective item(s) to us. A claim for expenses associated with making a claim for a defective product must be in writing and submitted to us with copies of supporting documents. The benefits given under our warranty are in addition to other rights and remedies of the customer under a law in relation to goods and services to which this warranty relates. Our goods come with guarantees that cannot be excluded under the Australian Consumer Law. You are entitled to a replacement or a refund for a major failure and compensation for any other reasonable foreseeable loss or damage. You are also entitled to have the goods repaired or replaced if the goods fail to be of acceptable quality and the failure does not amount to a major failure. Visit the Con-Serv website [www.con-serv.com.au](http://www.con-serv.com.au) for the detailed warranty policy.



**MOUNTING TO TIMBER**

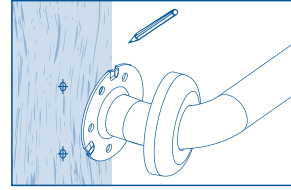

Place grab rail on wall in line with studs and mark location of screw holes.

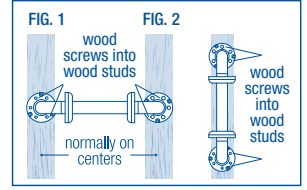
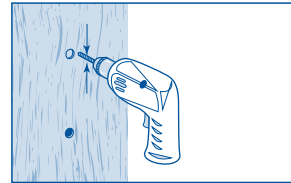
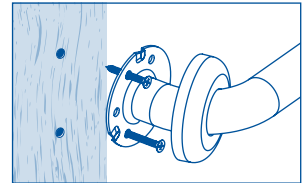

Fig. 1 - Horizontal attachment. Fig. 2 - Vertical attachment.



After marking, drill small hole to confirm location of stud.



Use 50mm x 14g self-tapping stainless steel screws supplied.

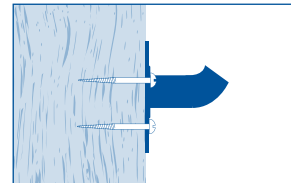

Ensure screws are fully engaged within substrate.

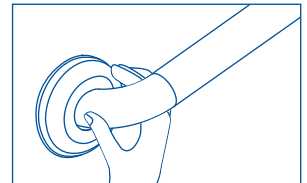

Press Clam Flange® covers over wall flanges.

**MOUNTING TO MASONRY**

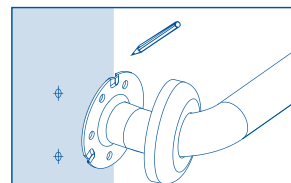

Place grab rail on wall and mark location of screw holes.

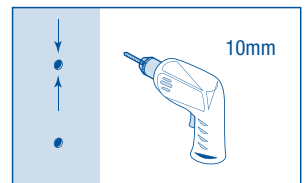

Drill 10mm holes.

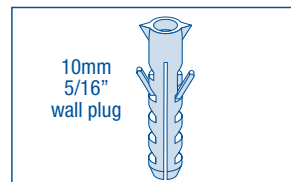

Use wall plugs supplied.

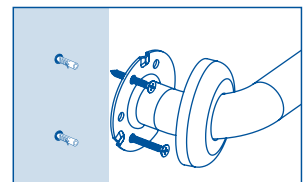

Use 50mm x 14g self-tapping stainless steel screws supplied.

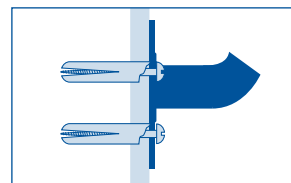

Ensure screws are fully engaged within substrate.

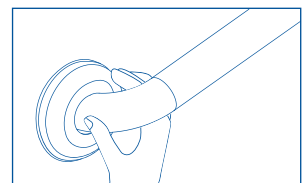

Press Clam Flange® covers over wall flanges.