

Selector® 3772 Escape Locks



Description

These locks have various latching functions which can be operated by key or handle outside and by turnknob, key or handle inside.

Product Details

Backset	Available in 60, 89 and 127mm backsets.
Furniture	Compatible with most Lockwood rose and plate furniture including Brass Door Furniture, Robert Watson Series, Artefact Series II, Ovation Series and VSR Series. Refer to lockweb.com.au for further details.
Latch	Deadlatch only.
Standard Finishes	Stainless Steel (SS) Other finishes available via finish kit conversions

Selector® 3772 Escape Locks

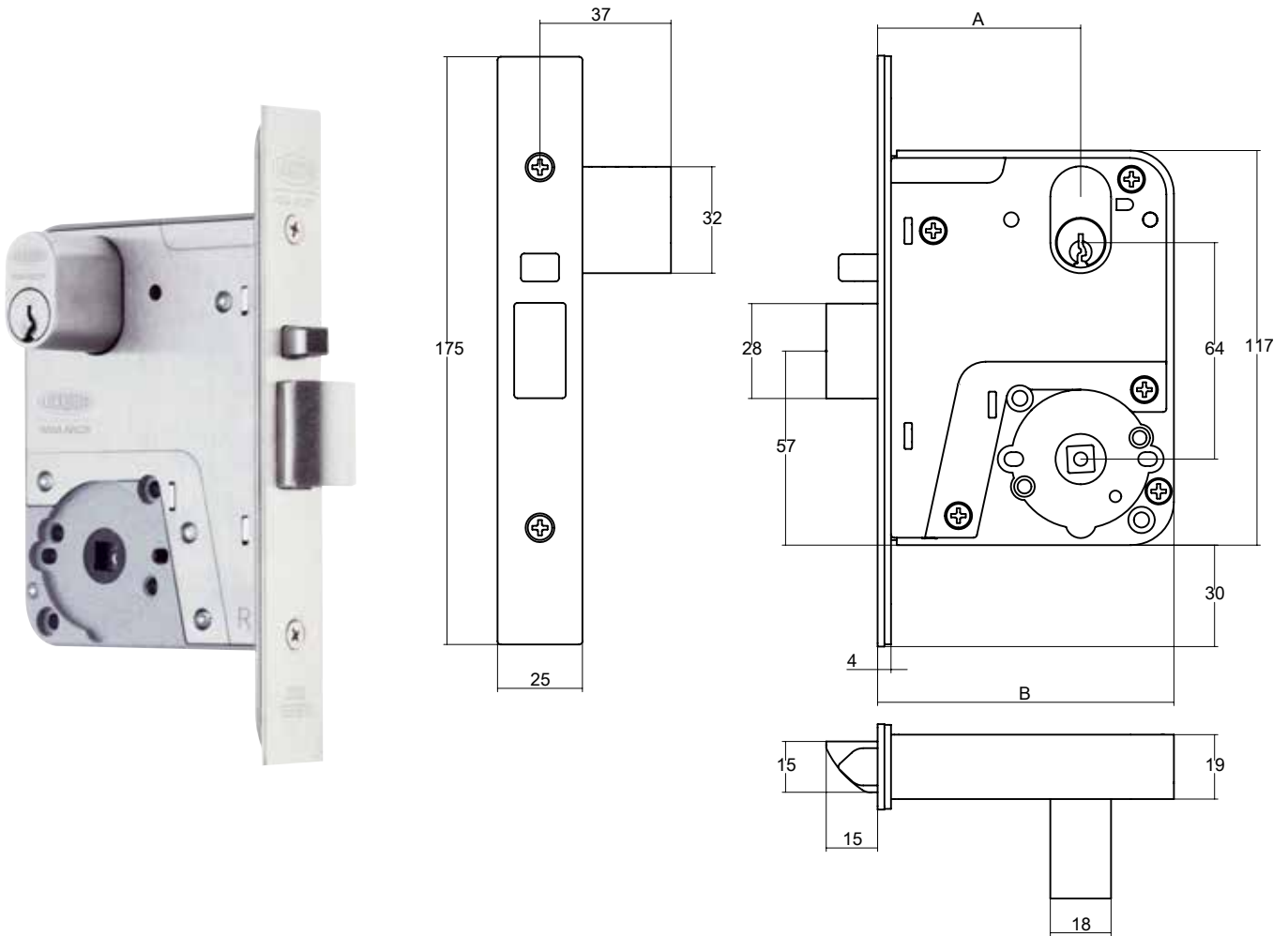

Selector® 3772 Escape Locks

Part Number	3772	4772	5772
Dimension A	60	89	127
Dimension B	88	117	155

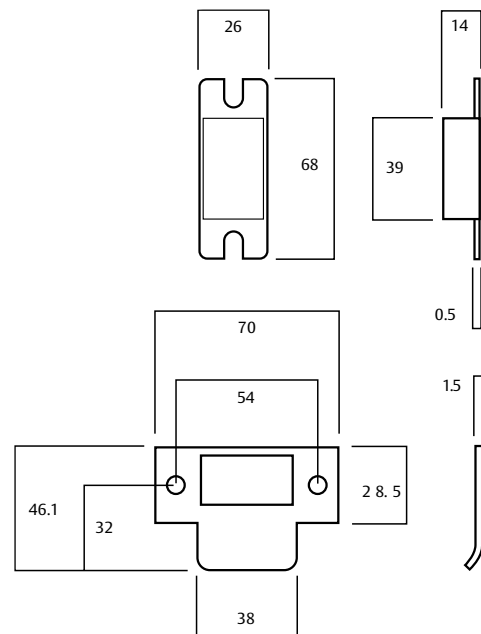

Selector[®] 3772 Escape Locks

Escape Lock

Part Number 3772--

Outside: Handle always rigid.

Inside: Opened by handle at all times.

This function requires the locking bar to be positioned in the locked position once lock is set.

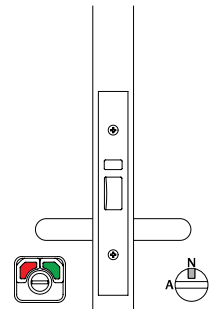

Anti-vandal Escape Lock

Part Number 3772V-

Single cylinder.

Outside: Opened by handle when unlocked. Key locks and unlocks outside handle and retracts bolt after unlocking lock.

Inside: Opened by handles at all times.

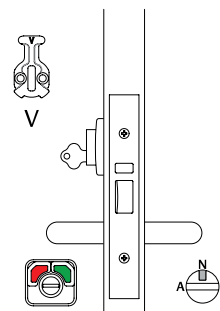

Anti-vandal Escape Lock with Turn

Part Number 3772VT

Cylinder and turnknob.

Outside: Opened by handle when unlocked. Key locks and unlocks outside handle and retracts bolt after unlocking lock.

Inside: Opened by handle at all times. Turnknob locks or unlocks outside handle.

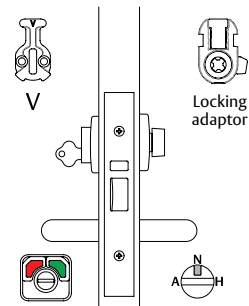

Key Entry Escape Lock

Part Number 3772X-

Single cylinder.

Outside: Opened by key at all times. Handle always rigid.

Inside: Opened by handle at all times.

This function requires the locking bar to be positioned in the locked position once lock is set.

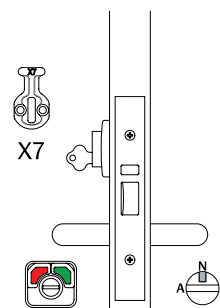

Notes:

All drawings shown are in right hand configuration. Part numbers shown above are for 60mm backset lock, if 89mm is required substitute 3 for 4 i.e. 4772, or if 127mm lock is required, substitute 3 for 5 i.e. 5772

Legend

Hub Setting



Lock Function Setting



Cam or Adaptor



Selector[®] 3772 Escape Locks

Key Entry Escape Lock with Turn

Part Number 3772XT

Cylinder and turnknob.

Outside: Opened by key at all times. Opened by handle when unlocked. Key locks outside handle.

Inside: Opened by handle at all times. Turnknob locks or unlocks outside handle.

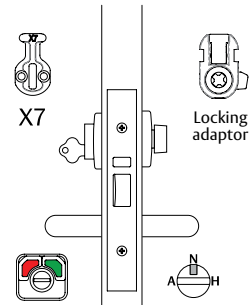

Escape Lock with Internal Cylinder

Part Number 3772-V

Single cylinder.

Outside: Opened by handle when unlocked.

Inside: Opened by handle at all times. Key locks or unlocks outside handle and retracts bolt after unlocking lock.

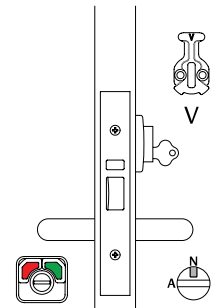

Escape Lock with Turn

Part Number 3772-T

Turnknob inside.

Outside: Opened by handle when unlocked.

Inside: Opened by handle at all times. Turnknob locks or unlocks outside handle.

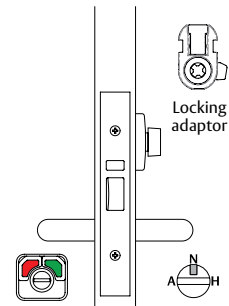

Anti-vandal Escape Lock with Internal Cylinder

Part Number 3772VV

Double Cylinder.

Outside: Opened by handle when unlocked. Key locks or unlocks outside handle and retracts bolt after unlocking lock.

Inside: Opened by handle at all times. Key locks or unlocks outside handle and retracts bolt after unlocking lock.

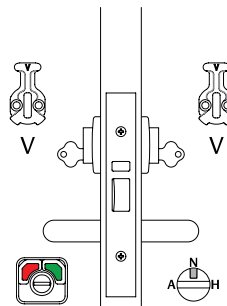

Notes:

All drawings shown are in right hand configuration. Part numbers shown above are for 60mm backset lock, if 89mm is required substitute 3 for 4 i.e. 4772, or if 127mm lock is required, substitute 3 for 5 i.e. 5772

Legend

Hub Setting



Lock Function Setting



Cam or Adaptor



Selector® 3772 Escape Locks

Key Entry Escape Lock with Internal Cylinder

Part Number 3772XV

Double cylinder.

Outside: Opened by key at all times. Opened by handle when unlocked. Key locks outside handle.

Inside: Opened by handle at all times. Key locks or unlocks outside handle and retracts bolt after unlocking lock.

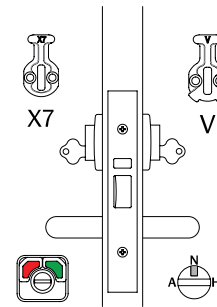

Anti-lockout Escape Lock with Turn*

Part Number 3772-TA

Turnknob inside.

Outside: Opened by handle when unlocked.

Inside: Opened by handle at all times. Turnknob locks or unlocks outside handle.

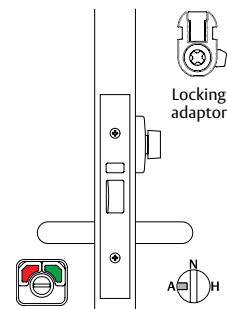

Anti-lockout Anti-vandal Escape Lock with Turn*

Part Number 3772VTA

Cylinder and turnknob.

Outside: Opened by handle when unlocked. Key locks or unlocks outside handle and retracts bolt after unlocking lock.

Inside: Opened by handle at all times. Turnknob locks or unlocks outside handle.

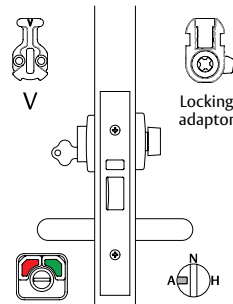

Holdback Anti-vandal Escape Lock#

Part Number 3772V-H

Single cylinder.

Outside: Opened by handle when unlocked. Key locks or unlocks outside handle and retracts bolt after unlocking lock.

Inside: Opened by handle at all times.

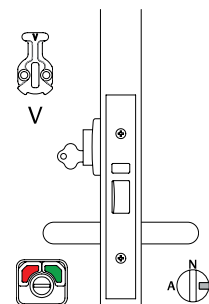

Notes:

All drawings shown are in right hand configuration. Part numbers shown above are for 60mm backset lock, if 89mm is required substitute 3 for 4 i.e. 4772, or if 127mm lock is required, substitute 3 for 5 i.e. 5772

*Anti-lockout - Closing the door or retracting latch bolt unlocks the lock, preventing lockout situations.

Holdback - Latch bolt can be held within the lock. **Holdback must not be activated on fire doors.**

For questions concerning our fire rated products, their specifications and their utilization please contact ASSA ABLOY or relevant Fire Door manufacturer.

Legend

Hub Setting



Lock Function Setting



Cam or Adaptor



Selector® 3772 Escape Locks

Holdback Anti-vandal Escape Lock with Turn#

Part Number 3772VTH

Cylinder and turnknob.

Outside: Opened by handle when unlocked. Key locks or unlocks outside handle and retracts bolt after unlocking lock.

Inside: Opened by handle at all times. Turnknob locks or unlocks outside handle.

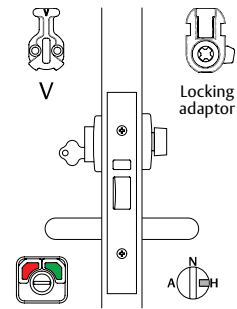

Holdback Key Entry Escape Lock with Internal Cylinder#

Part Number 3772XVH

Double cylinder.

Outside: Opened by key at all times. Opened by handle when unlocked. Key locks outside handle.

Inside: Opened by handle at all times. Key locks or unlocks outside handle and retracts bolt after unlocking lock.

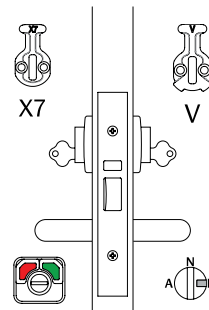

Notes:

All drawings shown are in right hand configuration.

Part numbers shown above are for 60mm backset lock, if 89mm is required substitute 3 for 4 i.e. 4772, or if 127mm lock is required, substitute 3 for 5 i.e. 5772

*Anti-lockout - Closing the door or retracting latch bolt unlocks the lock, preventing lockout situations.

#Holdback - Latch bolt can be held within the lock. **Holdback must not be activated on fire doors.**

For questions concerning our fire rated products, their specifications and their utilization please contact ASSA ABLOY or relevant Fire Door manufacturer.

Legend

Hub Setting



Lock Function Setting



Cam or Adaptor



**We take the worry out of
protecting what's valuable to you.**
Lockwood: *no worries*[®]



ASSA ABLOY

Lockwood is the leading brand in the Australian locking industry. With an established reputation for high quality products, this iconic brand provides a wide range of locking solutions to residential housing, commercial, semi-commercial, building and industrial application markets. Lockwood is supported by an extensive distribution and after-sales support network. Our customers include retailers, architects, trade and industrial personnel, locksmiths and security dealers.

ASSA ABLOY is the global leader in door opening solutions, dedicated to satisfying end-user needs for security, safety and convenience.

ASSA ABLOY is represented in all major regions, in both mature and emerging markets, with leading positions in Australia, Europe and North America.

**25YEAR
MECHANICAL
WARRANTY**

The Lockwood 25 Year Mechanical Warranty

Our belief that we manufacture the finest premium products available in today's market place is backed by the Lockwood 25 Year Mechanical Warranty, ensuring that Lockwood continues to keep Australians safe by delivering security and peace of mind.

For warranty terms and conditions, please visit www.lockweb.com.au or call **1300WARRANTY**

ASSA ABLOY Australia Pty Ltd
235 Huntingdale Road
Oakleigh, Victoria, 3166
Australia

1300 LOCK UP (1300 562 587)
lockweb.com.au

ASSA ABLOY New Zealand Ltd
6 Armstrong Road
Albany, Auckland, 0632
New Zealand

info.nz@assaabloy.com
Telephone +64 9415 7111
assaabloy.co.nz

Disclaimer

Whilst every effort has been made to ensure that the information (including product images and drawings) contained in this brochure is accurate at the time of publication, ASSA ABLOY Australia Pty Limited ("ASSA ABLOY") recommends that you consult ASSA ABLOY or its agents prior to placing an order to ascertain current information on specific products, as ASSA ABLOY reserves the right to make changes without notice. ASSA ABLOY will not be liable for any injury, loss or damage whatsoever, arising from any errors or omissions in the information contained in the brochure or arising from the use or application of the information contained herein. © 2016 copyright by ASSA ABLOY All rights reserved

