

Selector® 3782 Short Backset Escape Locks



Description

These locks have various latching functions operated generally by key or handle outside and by turnknob, key or handle inside. These locks comply with building regulations for single-action escape doors.

Product Details

Furniture	Compatible with Lockwood 4800 and 5800 Series Furniture. Refer to lockweb.com.au for further details.
Latch	Deadlatch only.
Standard Finishes	Stainless Steel (SS) Other finishes available via finish kit conversions.

Selector® 3782 Short Backset Escape Locks

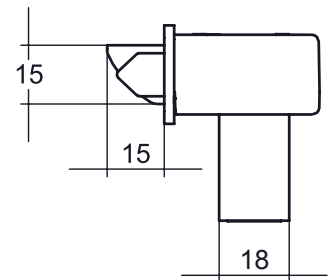
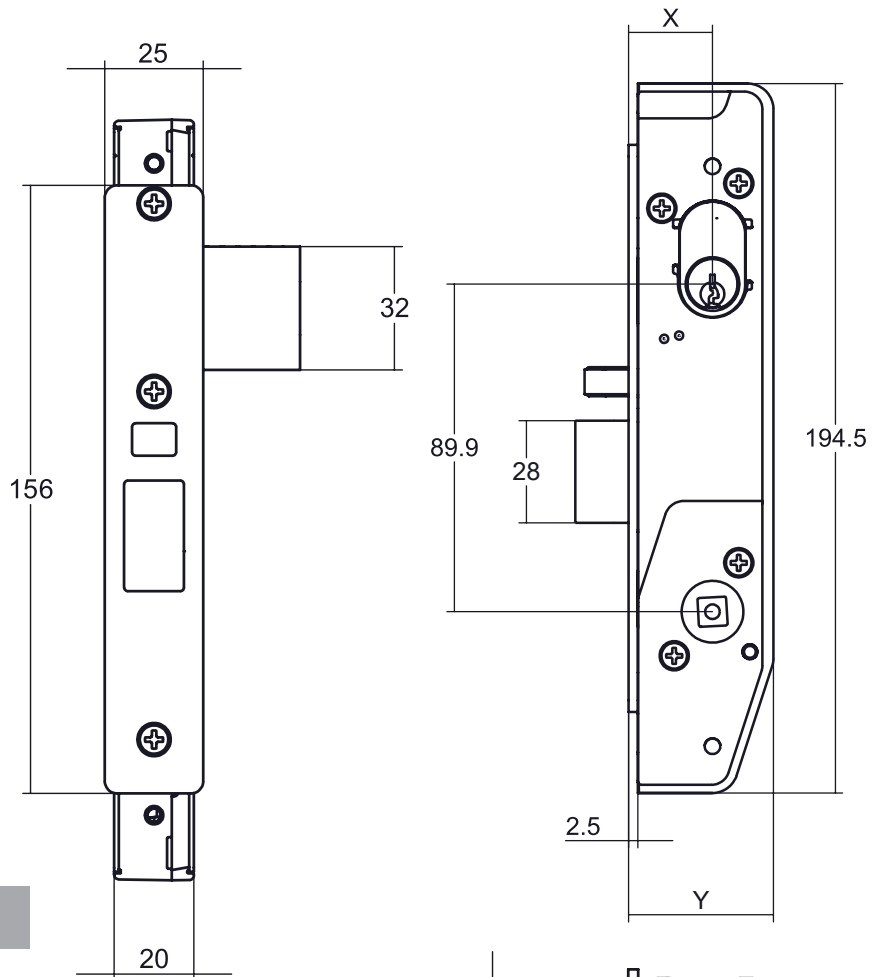

Selector® 3782 Short Backset Escape Locks

Part Number	3782	4782	5782	6782
Dimension X	23	25.4	30	38
Dimension Y	40	42.4	47	55
Minimum internal depth of door	40	43	47	55

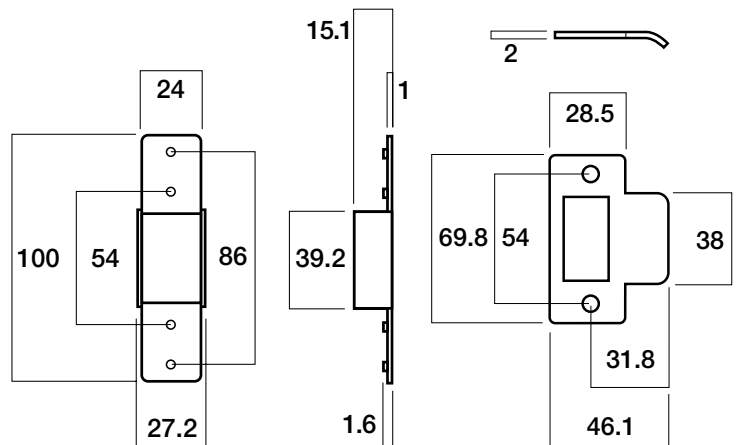

Selector® 3782 Short Backset Escape Locks

Escape Lock

Part Number 3782--

Outside: Handle always rigid.

Inside: Opened by handle at all times

This function requires the locking bar to be positioned in the locked position once lock is set.

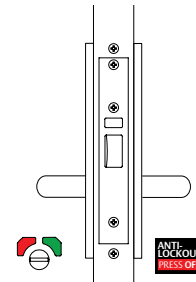

Anti-vandal Escape Lock[#]

Part Number 3782V-

Single cylinder.

Outside: Opened by handle when unlocked. Key locks or unlocks outside handle and retracts bolt after unlocking lock.

Inside: Opened by handle at all times.

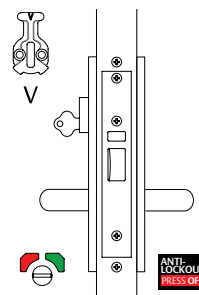

Anti-vandal Escape Lock with Turn[#]

Part Number 3782VT

Cylinder and turnknob.

Outside: Opened by handle when unlocked. Key locks or unlocks outside handle and retracts bolt after unlocking lock.

Inside: Opened by handle at all times. Turnknob locks or unlocks outside handle.

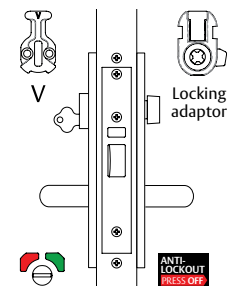

Key Entry Escape Lock

Part Number 3782X-

Single cylinder.

Outside: Opened by key at all times. Handle always rigid.

Inside: Opened by handle at all times.

This function requires the locking bar to be positioned in the locked position once lock is set.

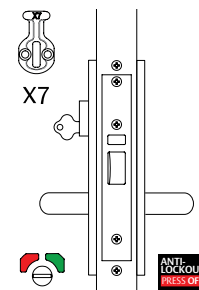

Notes:

All drawings shown are in right hand configuration. Part numbers shown above are for 23mm backset lock, if 25.4mm is required substitute 3 for 4 i.e. 4782, or if 30mm or 38mm lock is required, substitute 5 for 5 or 6 respectively i.e. 5782, 6782

*Anti-lockout - Closing the door or retracting latch bolt unlocks the lock, preventing lockout situations.

#Latch bolt can be held within the lock. Lock function recommended for use in holdback application.

Legend

Hub Setting



Anti-lockout Selection



Cam or Adaptor



Selector® 3782 Short Backset Escape Locks

Key Entry Escape Lock with Turn#

Part Number 3782XT

Cylinder and turnknob.

Outside: Opened by key at all times. Opened by handle when unlocked. Key locks outside handle.

Inside: Opened by handle at all times. Turnknob locks or unlocks outside handle.

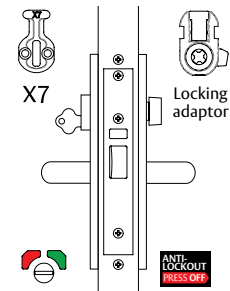

Escape Lock with Internal Cylinder#

Part Number 3782-V

Cylinder inside.

Outside: Opened by handle when unlocked.

Inside: Opened by handle at all times. Cylinder locks or unlocks outside handle and retracts bolt after unlocking lock.

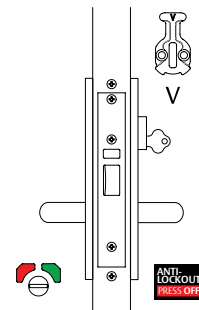

Escape Lock with Turn#

Part Number 3782-T

Turnknob inside.

Outside: Opened by handle when unlocked.

Inside: Opened by handle at all times. Turnknob locks or unlocks outside handle.

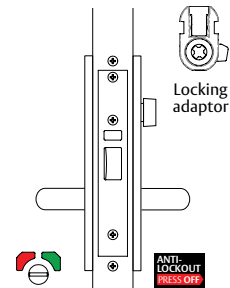

Key Entry Escape Lock with Internal Cylinder#

Part Number 3782XV

Double Cylinder.

Outside: Opened by key at all times. Opened by handle when unlocked. Key locks outside handle.

Inside: Opened by handle at all times. Key locks or unlocks outside handle and retracts bolt after unlocking lock.

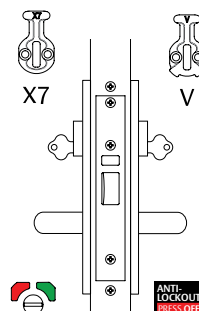

Notes:

All drawings shown are in right hand configuration. Part numbers shown above are for 23mm backset lock, if 25.4mm is required substitute 3 for 4 i.e. 4782, or if 30mm or 38mm lock is required, substitute 3 for 5 or 6 respectively i.e. 5782, 6782

*Anti-lockout - Closing the door or retracting latch bolt unlocks the lock, preventing lockout situations.

#Latch bolt can be held within the lock. Lock function recommended for use in holdback application.

Legend	
Hub Setting	
Anti-lockout Selection	
Cam or Adaptor	

Selector® 3782 Short Backset Escape Locks

Anti-lockout Escape Lock with Turn*

Part Number 3782-TA

Turnknob inside.

Outside: Opened by handle when unlocked.

Inside: Opened by handle at all times. Turnknob locks or unlocks outside handle.

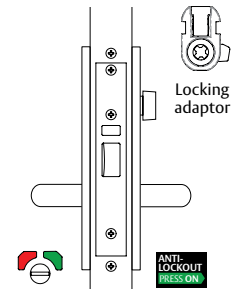

Anti-lockout Anti-vandal Escape Lock with Turn*

Part Number 3782VTA

Cylinder and turnknob.

Outside: Opened by handle when unlocked. Key locks or unlocks outside handle and retracts bolt after unlocking lock.

Inside: Opened by handle at all times. Turnknob locks or unlocks outside handle.

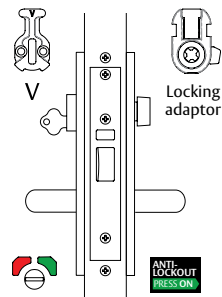

Notes:

All drawings shown are in right hand configuration. Part numbers shown above are for 23mm backset lock, if 25.4mm is required substitute 3 for 4 i.e. 4782, or if 30mm or 38mm lock is required, substitute 3 for 5 or 6 respectively i.e. 5782, 6782

*Anti-lockout - Closing the door or retracting latch bolt unlocks the lock, preventing lockout situations.

#Latch bolt can be held within the lock. Lock function recommended for use in holdback application.

Legend

Hub Setting



Anti-lockout Selection



Cam or Adaptor



Selector® 3784 Short Backset Combination Locks



Description

These locks have various latching functions operated generally by outside or inside handles, except when locked by key outside or by key or turnknob inside.

Product Details

Furniture	Compatible with Lockwood 4800 and 5800 Series Furniture. Refer to lockweb.com.au for further details.
Latch	Deadlatch only.
Standard Finishes	Stainless Steel (SS) Other finishes available via finish kit conversions.

Selector® 3784 Short Backset Combination Locks

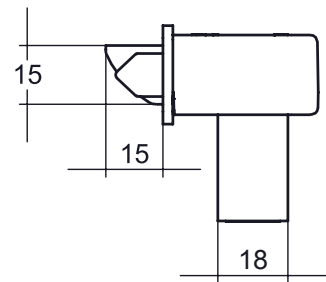
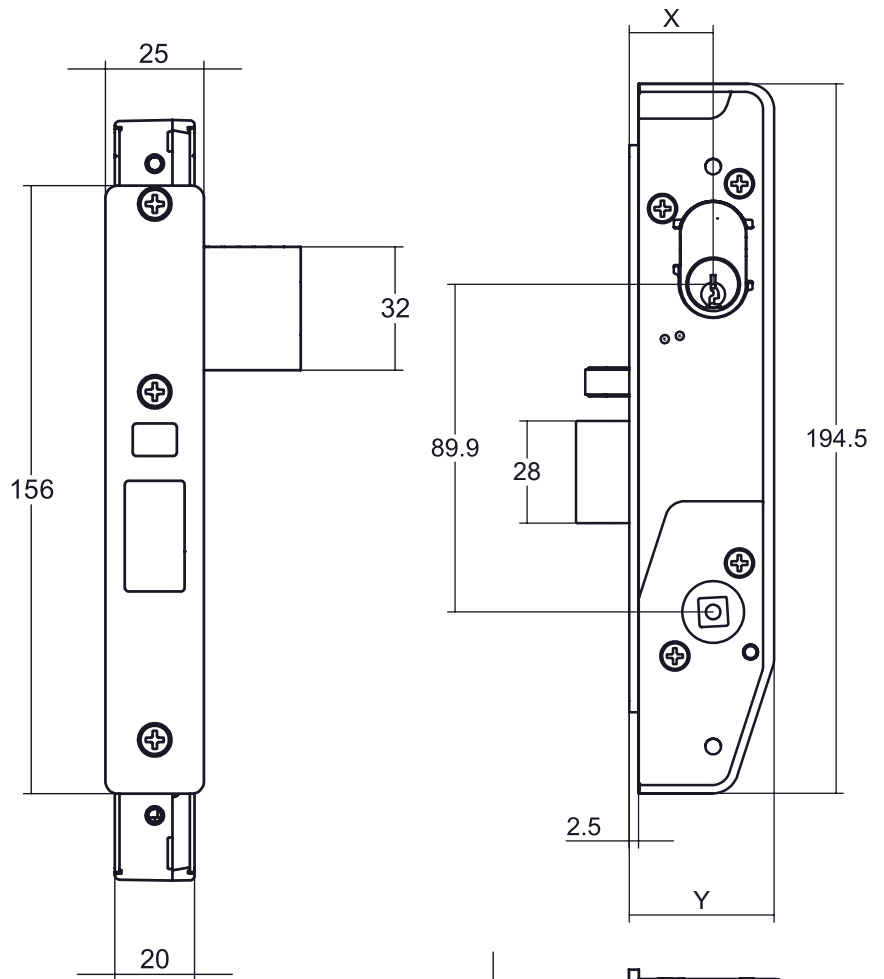

Selector® 3784 Short Backset Combination Locks

Part Number	3784	4784	5784	6784
Dimension X	23	25.4	30	38
Dimension Y	40	42.4	47	55
Minimum internal depth of door	40	43	47	55

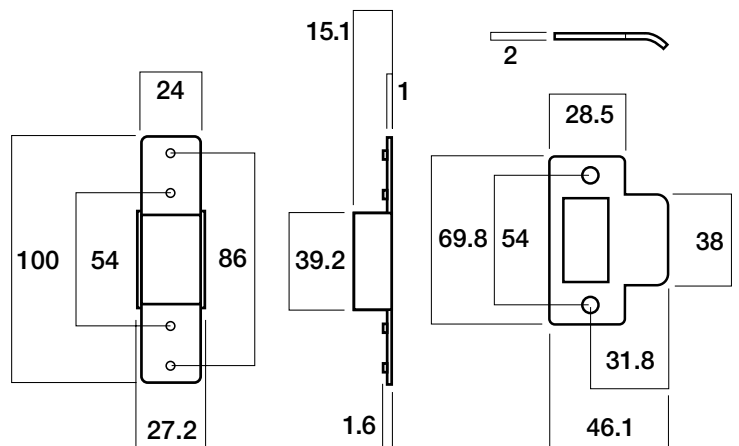

Selector® 3784 Short Backset Combination Locks

Passage Latch	
Part Number	3784

No locking function. Plainlatch only.
Outside: Opened by handle at all times.
Inside: Opened by handle at all times.

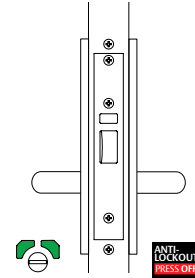

Anti-vandal Lock with Turn#	
Part Number	3784VT

Cylinder and turnknob.
Outside: Opened by handle when unlocked. Key locks or unlocks both handles and retracts bolt after unlocking lock.
Inside: Opened by handle when unlocked. Turnknob locks or unlocks both handles.

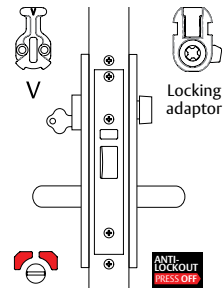

Anti-vandal Lock with Internal Cylinder#	
Part Number	3784VV

Double cylinder.
Outside: Opened by handle when unlocked. Key locks or unlocks both handles and retracts bolt after unlocking lock.
Inside: Opened by handle when unlocked. Key locks or unlocks both handles and retracts bolt after unlocking lock.

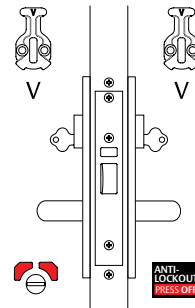

Key Entry Lock with Internal Cylinder#	
Part Number	3784XV

Double cylinder.
Outside: Opened by key at all times. Opened by handle when unlocked. Key locks both handles.
Inside: Opened by handle when unlocked. Key locks or unlocks both handles and retracts bolt after unlocking lock.

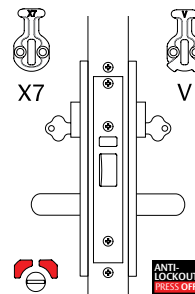

Notes:
 All drawings shown are in right hand configuration. Part numbers shown above are for 23mm backset lock, if 25.4mm is required substitute 3 for 4 i.e. 4784, or if 30mm or 38mm lock is required, substitute 3 for 5 or 6 respectively i.e. 5784, 6784
 *Anti-lockout - Closing the door or retracting latch bolt unlocks the lock, preventing lockout situations.
 #Latch bolt can be held within the lock. Lock function recommended for use in holdback application.

Legend	
Hub Setting	
Anti-lockout Selection	
Cam or Adaptor	

Selector® 3784 Short Backset Combination Locks

Key Entry Double Cylinder Lock

Part Number 3784XX

Double cylinder.

Outside: Opened by key at all times. Handle always rigid.

Inside: Opened by key at all times. Handle always rigid.

This function requires the locking bar to be positioned in the locked position once lock is set.

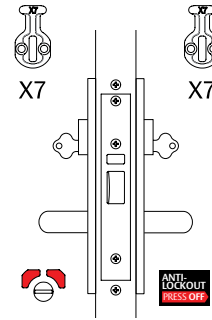

Combination Lock with Turn#

Part Number 3784-T

Turnknob inside.

Outside: Opened by handle when unlocked.

Inside: Opened by handle when unlocked. Turnknob locks or unlocks both handles.

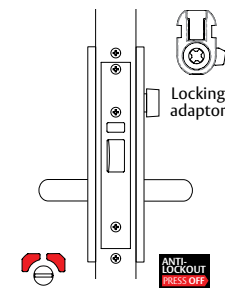

Anti-lockout Combination Lock with Turn*

Part Number 3784-TA

Turnknob inside.

Outside: Opened by handle when unlocked.

Inside: Opened by handle when unlocked. Turnknob locks or unlocks both handles.

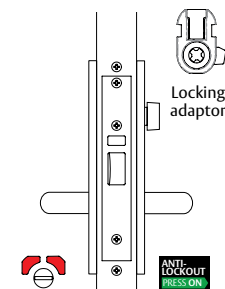

Anti-lockout Anti-vandal Lock with Turn*

Part Number 3784VTA

Cylinder and turnknob.

Outside: Opened by handle when unlocked. Key locks or unlocks both handles and retracts bolt after unlocking lock.

Inside: Opened by handle when unlocked. Turnknob locks or unlocks both handles.

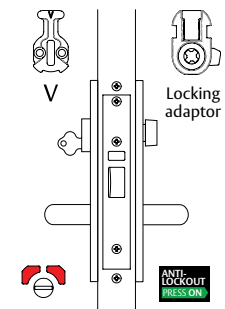

Notes:

All drawings shown are in right hand configuration. Part numbers shown above are for 23mm backset lock, if 25.4mm is required substitute 3 for 4 i.e. 4784, or if 30mm or 38mm lock is required, substitute 3 for 5 or 6 respectively i.e. 5784, 6784

*Anti-lockout - Closing the door or retracting latch bolt unlocks the lock, preventing lockout situations.

#Latch bolt can be held within the lock. Lock function recommended for use in holdback application.

Legend

Hub Setting



Anti-lockout Selection



Cam or Adaptor



Selector® 3784 Short Backset Combination Locks

Anti-lockout Anti-vandal Lock with Internal Cylinder*

Part Number 3784VVA

Double cylinder.

Outside: Opened by handle when unlocked. Key locks or unlocks both handles and retracts bolt after unlocking lock.

Inside: Opened by handle when unlocked. Key locks or unlocks both handles and retracts bolt after unlocking lock.

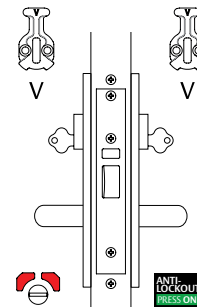

Notes:

All drawings shown are in right hand configuration. Part numbers shown above are for 23mm backset lock, if 25.4mm is required substitute 3 for 4 i.e. 4784, or if 30mm or 38mm lock is required, substitute 3 for 5 or 6 respectively i.e. 5784, 6784

*Anti-lockout - Closing the door or retracting latch bolt unlocks the lock, preventing lockout situations.

#Latch bolt can be held within the lock. Lock function recommended for use in holdback application.

Legend	
Hub Setting	
Anti-lockout Selection	
Cam or Adaptor	

**We take the worry out of
protecting what's valuable to you.**
Lockwood: *no worries*[®]



ASSA ABLOY

Lockwood is the leading brand in the Australian locking industry. With an established reputation for high quality products, this iconic brand provides a wide range of locking solutions to residential housing, commercial, semi-commercial, building and industrial application markets. Lockwood is supported by an extensive distribution and after-sales support network. Our customers include retailers, architects, trade and industrial personnel, locksmiths and security dealers.

ASSA ABLOY is the global leader in door opening solutions, dedicated to satisfying end-user needs for security, safety and convenience.

ASSA ABLOY is represented in all major regions, in both mature and emerging markets, with leading positions in Australia, Europe and North America.

**25YEAR
MECHANICAL
WARRANTY**

The Lockwood 25 Year Mechanical Warranty

Our belief that we manufacture the finest premium products available in today's market place is backed by the Lockwood 25 Year Mechanical Warranty, ensuring that Lockwood continues to keep Australians safe by delivering security and peace of mind.

For warranty terms and conditions, please visit www.lockweb.com.au or call **1300WARRANTY**

ASSA ABLOY Australia Pty Ltd
235 Huntingdale Road
Oakleigh, Victoria, 3166
Australia

1300 LOCK UP (1300 562 587)
lockweb.com.au

ASSA ABLOY New Zealand Ltd
6 Armstrong Road
Albany, Auckland, 0632
New Zealand

info.nz@assaabloy.com
Telephone +64 9415 7111
assaabloy.co.nz

Disclaimer

Whilst every effort has been made to ensure that the information (including product images and drawings) contained in this brochure is accurate at the time of publication, ASSA ABLOY Australia Pty Limited ("ASSA ABLOY") recommends that you consult ASSA ABLOY or its agents prior to placing an order to ascertain current information on specific products, as ASSA ABLOY reserves the right to make changes without notice. ASSA ABLOY will not be liable for any injury, loss or damage whatsoever, arising from any errors or omissions in the information contained in the brochure or arising from the use or application of the information contained herein. © 2016 copyright by ASSA ABLOY All rights reserved

