

Synergy 3574 Combination Latches



Description

Various latching functions operated generally by outside or inside handles, except when locked by key outside or by key or turnknob inside.

For ease of selection specify primary lock (3572SC). This lock can then be easily adapted to function required.

Note: Passage set available with plain latch only (3574SC).

Product Details

Backset	Available in 60, 89 and 127mm backsets.
Furniture	Compatible with most Lockwood rose and plate furniture including Brass Door Furniture, Daintree, Aquileart, Artefact Series II and Ovation Series. Refer to lockweb.com.au for further details.
Latch	Deadlatch for locking functions. Plain latch for passage function.
Standard Finishes	Satin Chrome Brushed (SC) Chrome Plate (CP) Polished Brass (PB) Other finishes on application.

Synergy 3574 Combination Latches

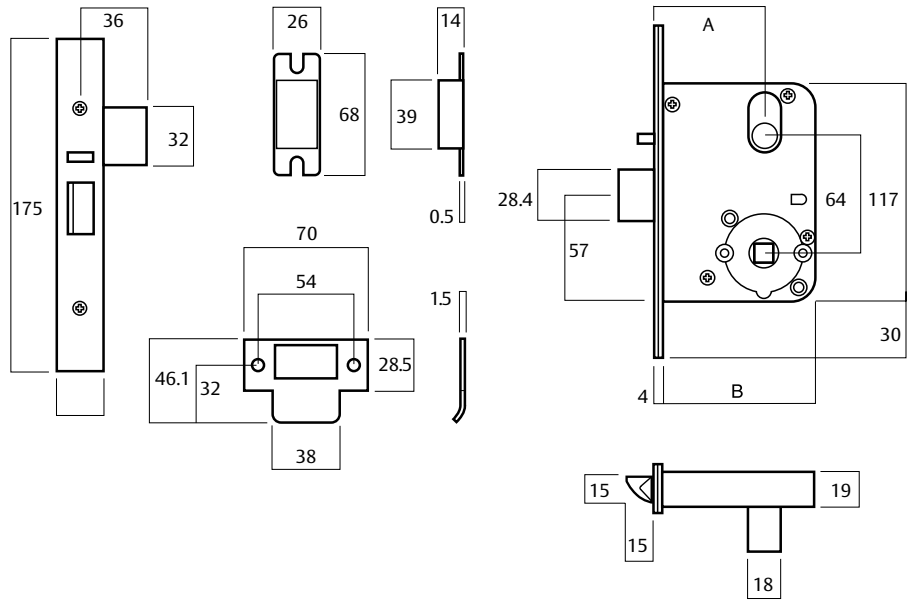

Synergy 3574 Combination Latches

Part Number	3572	4572	5572
Dimension A	60	89	127
Dimension B	84	113	151

Synergy 3574 Combination Latches

3574 Combination Latches

Office Locking Latch

Part Number	Description
3574WTR	Right hand
3574WTL	Left hand

Description

Cylinder and turnknob. Reversible.

Outside: Opened by handle except when handle is made inoperative by key from outside or by turnknob from inside. Key locks or unlocks both handles.

Inside: Opened by handle except when handle is made inoperative by key from outside or turnknob from inside. Turnknob locks or unlocks both handles.

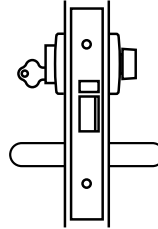

Glass Door Locking Latch

Part Number	3574ZZ
-------------	--------

Description

Double Cylinder. Non-handed.

Outside: Opened by handle except when handle is made inoperative by key from either side. Key from either side locks or unlocks both handles.

Inside: Opened by handle except when handle is made inoperative by key from either side. Key from either side locks or unlocks both handles.

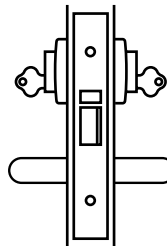

Synergy 3574 Combination Latches

Glass Door Locking Latch

Part Number	Description
3574Z-R	Right hand
3574Z-L	Left hand

Description

Cylinder and outside. Reversible.

Outside: Opened by handle except when handle is made inoperative by key from outside. Key locks or unlocks both handles.

Inside: Opened by handle except when handle is made inoperative by key from outside.

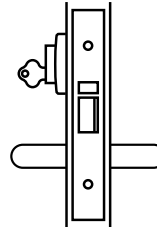

Passage Latch

Part Number	3574
-------------	------

Description

No locking function. Non-handed. Plainlatch only.

Outside: Opened by handle.

Inside: Opened by handle.

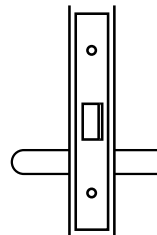

Synergy 3574 Combination Latches

Privacy Latch

Part Number	Description
3574ETR	Right hand
3574ETL	Left hand

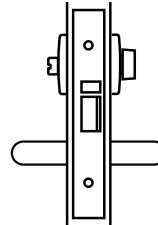

Description

Emergency button and turnknob. Reversible..

Outside: Opened by handle except when handle is made inoperative by emergency turnknob from outside or turnknob from inside. Emergency turnknob locks or unlocks both handles.

Inside: Opened by handle except when handle is made inoperative by emergency turnknob from outside or turnknob from inside. Emergency turnknob locks or unlocks both handles.

Glass Door Locking Latch

Part Number	Description
3574XZR	Right hand
3574XZL	Left hand

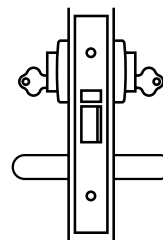

Description

Cylinder outside. Reversible.

Outside: Opened by key at all times.

Opened by handle except when handle is made inoperative by key from inside. Key retracts latchbolt.

Inside: Opened by handle except when handle is made inoperative by key from inside. Key locks or unlocks both handles.

Note: Part numbers shown above are for 60mm backset lock, if 89mm is required substitute 3 for 4 i.e. 4572Z-R, or if 127mm lock is required, substitute 3 for 5 i.e. 5572Z-R



ASSA ABLOY

Lockwood is the leading brand in the Australian locking industry. With an established reputation for high quality products, this iconic brand provides a wide range of locking solutions to residential housing, commercial, semi-commercial, building and industrial application markets. Lockwood is supported by an extensive distribution and after-sales support network. Our customers include retailers, architects, trade and industrial personnel, locksmiths and security dealers.

ASSA ABLOY is the global leader in door opening solutions, dedicated to satisfying end-user needs for security, safety and convenience.

ASSA ABLOY is represented in all major regions, in both mature and emerging markets, with leading positions in Australia, Europe and North America.

**25YEAR
MECHANICAL
WARRANTY**

The Lockwood 25 Year Mechanical Warranty

Our belief that we manufacture the finest premium products available in today's market place is backed by the Lockwood 25 Year Mechanical Warranty, ensuring that Lockwood continues to keep Australians safe by delivering security and peace of mind.

For warranty terms and conditions, please visit www.lockweb.com.au or call **1300WARRANTY**

ASSA ABLOY Australia Pty Ltd
235 Huntingdale Road
Oakleigh, Victoria, 3166
Australia

1300 LOCK UP (1300 562 587)
lockweb.com.au

ASSA ABLOY New Zealand Ltd
6 Armstrong Road
Albany, Auckland, 0632
New Zealand

info.nz@assaabloy.com
Telephone +64 9415 7111
assaabloy.co.nz

