

KINCROME

HEAVY DUTY PRESSURE SPRAYER 1.5L LITRE



K16020 & K16021

ED1 / FEB 2021

Table Of Contents

Know Your Product	2
Specifications	2
Uses and Safety Regulations	3
Chemical Guide.....	4
Field of Application	6
Setting up & Spraying.....	6
Maintenance.....	6
Spare Parts	7
Notes.....	7

Know Your Product



1. Nozzle
2. Plunger with Handle
3. Pressure Relief Valve (2.5bar)
4. Handle with Safety Lock
5. Tank

Specifications



Part No.:..... K16020
Max. Pressure:..... 2.5bar
Standard Nozzles:.....Adjustable Conical Nozzle & Fan
Usable Capacity:..... 1.5l
Total Capacity: 1.9l

Litres. Min. 3 Bar:.....0.50l/min
Gross Weight:.....0.56kg
Net Weight:0.70kg



Part No.:.....K16020
Max. Pressure:.....2.5bar
Standard Nozzles:.....Adjustable Conical Nozzle & Fan
Usable Capacity:.....1.5l

Total Capacity:1.9l
Litres. Min. 3 Bar:.....0.50l/min
Gross Weight:.....0.56kg
Net Weight:0.70kg



Because a sprayer is a tool for spraying chemicals, some special safety precautions must be observed as with any other tool to reduce the risk of personal injury. Careless or improper use may cause serious or even fatal injury



It is important that you read, fully understand and observe the following general safety precautions and warnings. Read the instruction manual and the safety precautions periodically. In addition, read and follow the chemical manufacturer's instructions for the chemical products being applied. Since such products may vary greatly in handling/application requirements and risks, the chemical product label is normally your best guide for safe and effective use.

Uses And Safety Regulations

1. You must be in good physical condition and mental health and not under the influence of any substance (drugs, alcohol, etc.) which might impair vision, dexterity or judgment. Do not operate this hand held sprayer when you are fatigued
2. Always follow the instructions and dosages on the packaging labels, that the manufacturer recommends for the chemical product to be used.
3. To avoid any consumption of the product, do not eat, drink or smoke while preparing and spraying.
4. Do not spray on people, animals, electrical installations, flames, open fire, or other sources of ignition.
5. In case of poisoning, consult your doctor, taking the chemical product packaging with you.
6. Never dispose of waste product or cleaning residues near water courses, wells, etc.
7. Use suitable safety equipment, to reduce the risk of injury when working with chemical agents, the operator should wear proper protective apparel when filling, using and cleaning the sprayer. Always follow all of the chemical manufacturer's instructions with respect to proper eye, skin, nose and mouth protection. They may differ from and exceed the following precautions..
8. Read the instructions for the sprayer before its use. Do not modify the sprayer. Do not connect it to an external pressure source (manual use only). Do not obstruct or strike the safety valve. Do not use the sprayer if it is damaged, deformed or altered from its original shape. Store the sprayer protected from frost and extreme heat [between 5°C and 30° C(40°F & 85°F)]. Should the hose, tank, handle or any of its connections be damaged, do not attempt to repair but replace the items with new parts.
9. You must be in good physical condition and mental health and not under the influence of any substance (drugs, alcohol, etc.) which might impair vision, dexterity or judgment. Do not operate this hand held sprayer when you are fatigued
10. This device is not intended for use by persons (including children) with reduced physical, sensory or mental abilities or lacking experience and/or knowledge, unless they are supervised by a person responsible for their safety or are instructed by these persons on the use of the device.
11. Children should be supervised, to ensure that they do not play with the device.
12. Keep packaging film away from children- risk of suffocation,
13. Use the device only with compatible substances (Scope of Application).
14. The safety valve should not be removed.
15. Never purge nozzles or valves by blowing with your mouth.
16. Use only spare parts and accessories from the manufacturer.
17. We will not be held liable for any damage caused by the use of foreign parts.
18. De-pressurise the tank completely before filling, after use and before carrying out work relating to maintenance.
19. Once the spraying work is finished, lock the handle to avoid any involuntary operation.

Chemical product table

The following table shows several examples of the most frequently used aggressive substances recommended for each use. Follow the maximum percentages indicated.

Given the wide variety of products on the market, Kincrome does not warrant the universal validity of its products. Always use caution when working and follow the instructions of the chemical manufacturer.

Acids	ACETIC ACID (MAX 20%)	✓	
	HYDROCHLORIC ACID (MAX 30%)	✓	
	HYDROFLUORIC ACID (MAX 20%)	✓	
	PHOSPHORIC ACID	✓	
	NITRIC ACID (MAX 20%)	✓	
	Alcohols	BUTANOL	✓
		ETHANOL	✓
METHANOL		✓	
OTHER ALCOHOLS		✓	
Aliphatic Hydrocarbons	DECANE	✓	
	HEPTANE	✓	
	HEXANE	✓	
	LIMONENE	✓	
	PENTANO	✓	
Aromatic Hydrocarbons	NAPHTHALENE	✓	
	TOLUENE (MAX 40%)	✓	
	XYLENE	✓	
Oils & Petroleum Products	MINERAL/VEGETABLE OIL	✓	
	DIESEL OIL	✓	
	GASOLINE	✓	
	KEROSENE	✓	
	WHITE SPIRIT	✓	
Alkalines & Ketones	ACETONE	✗	
	AMMONIA	✓	
	SODIUM HYDROXIDE (CAUSTIC SODA)	✗	
	POTASSIUM HYDROXIDE (CAUSTIC POTASH)	✗	
	SODIUM HYPOCHLORITE	✓	

✓ OPTIMAL

✓ SUITABLE

✗ NOT SUITABLE

1

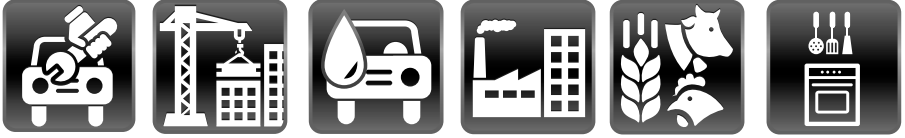

2

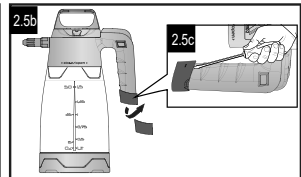
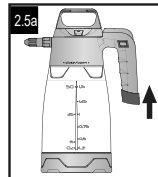
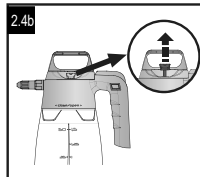
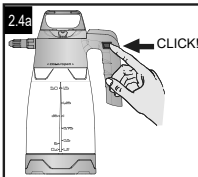
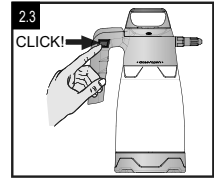
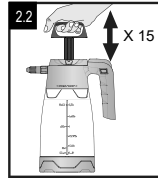
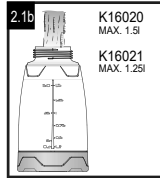
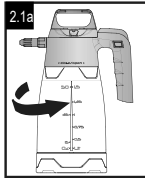

3

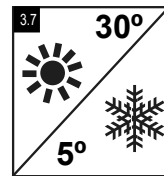
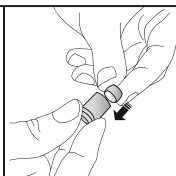
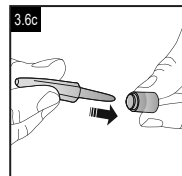
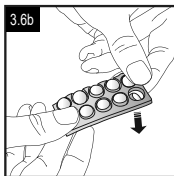
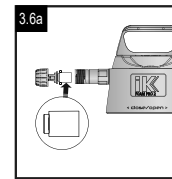
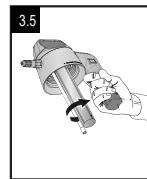
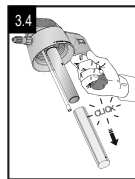
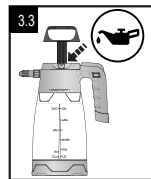
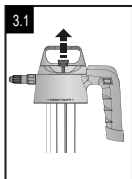

4



Field of Application

Range of sprayers equipped with the highest performance in terms of safety and ease of use. Designed to provide greater durability and versatility for professional use against the most aggressive chemicals in various sectors (cleaning and disinfection, construction, automotive and industrial warehouses and workshops, etc.). Particularly acid-resistant. Given the great variety of products in the market, Kincrome cannot guarantee the universal validity of its equipment. In any case, we recommend using certified chemicals.

Setting up & Spraying



You must be in good physical condition and mental health and not under the influence of any substance (drugs, alcohol, etc.) which might impair vision, dexterity or judgment. Do not operate this handheld sprayer when you are fatigued.

Always inspect your sprayer before and after each use. To reduce the risk of leakage and skin contact with chemicals, check that the cap is tight, and in good condition before pressurizing the container.

1. Stand the tank on a level surface
2. Unscrew the sprayer head by turning it anticlockwise (Figure 2.1a).
3. Fill up with thoroughly mixed plant protection/cleaning product. Do not exceed maximum capacity of the indicated maximum for the pressure sprayer (Figure 2.1b).
4. Screw tightly to close.
5. Pressurise the device by pumping plunger trigger (approx. 15-20 times) (Figure 2.2).
6. To begin spraying, make sure the safety lock is off (Figure 2.3).
7. Press the handle and, as you work, compensate for the loss in pressure by making more passes.
8. Once the work is finished, activate the safety lock (Figure 2.4a) and release the pressure by pulling the safety valve (Figure 2.4b).
9. If more than one appliance is used with different chemicals, use the identification marker to identify the contents of each appliance by placing it on the end of the handle (Figure 2.5a). To remove it, pull it in the direction shown by the arrows (Figure 2.5b) using a tool or pointed instrument (Figure 2.5c).

After Finishing Work

Always release the pressure out of the container after finishing work. To release the pressure, turn the knurled wheel on the pressure relief valve while holding the unit upright until there is no more air or mist coming out. Open the cover slowly to make sure that the container is completely de-pressurized. Avoid breathing in the mist which is released. Always wash thoroughly with soap and water after spraying or handling chemicals. Shower immediately, and wash all protective clothing separately. Follow any additional recommendations of the chemical manufacturer. Always clean dust and dirt off the sprayer.

Maintenance

K16020

1. After each use, de-pressurise the sprayer (Figure 3.1).
2. Collect and dispose of the residual amount of chemical according to the legislation, prescriptions, and applicable regulations.
3. Clean the appliance with water.
4. In the event of obstruction of the nozzle, clean it with water and do not use metallic objects (Figure 3.2).
5. In order to prolong the life of the joints, regularly apply some drops of oil or grease on the moving parts (Figure 3.3).
6. To access the valve chamber, remove the cylinder guard by pulling it firmly (Figure 3.4).
7. To access the rod's O-ring, unscrew the piston and remove it until leaving visible the aforementioned O-ring (Figure 3.5).
8. Store the sprayer indoors protected from frost and extreme heat (between 5°C and 30°C [40°F & 85°F]) (Figure 3.7).

K16021

1. After each use, de-pressurise the sprayer (Figure 3.1).
2. Collect and dispose of the residual amount according to the legislation, prescriptions, and applicable regulations.
3. Clean the appliance with water.
4. In the event of obstruction of the nozzle, clean it with water and do not use metallic objects (Figure 3.2).
5. In order to prolong the life of the joints, regularly apply some drops of oil or grease on the moving parts (Figure 3.3).
6. To access the valve chamber, remove the cylinder guard by pulling it firmly (Figure 3.4).
7. To access the rod's O-ring, unscrew the piston and remove it until leaving visible the aforementioned O-ring (Figure 3.5).
8. The apparatus has a felt pad installed in front of the nozzle (Figure 3.6a). This filter is to be cleaned with water when it is dirty. If it is completely damaged or is extremely dirty, replace it with a spare part. In the device there is a strip with 10 supplementary filters (Figure 3.6b). Remove the used filter using a pointed object. (Figure 3.6c).
9. Store the sprayer indoors protected from frost and extreme heat (between 5°C and 30°C [40°F & 85°F]) (Figure 3.7).

Spare Parts

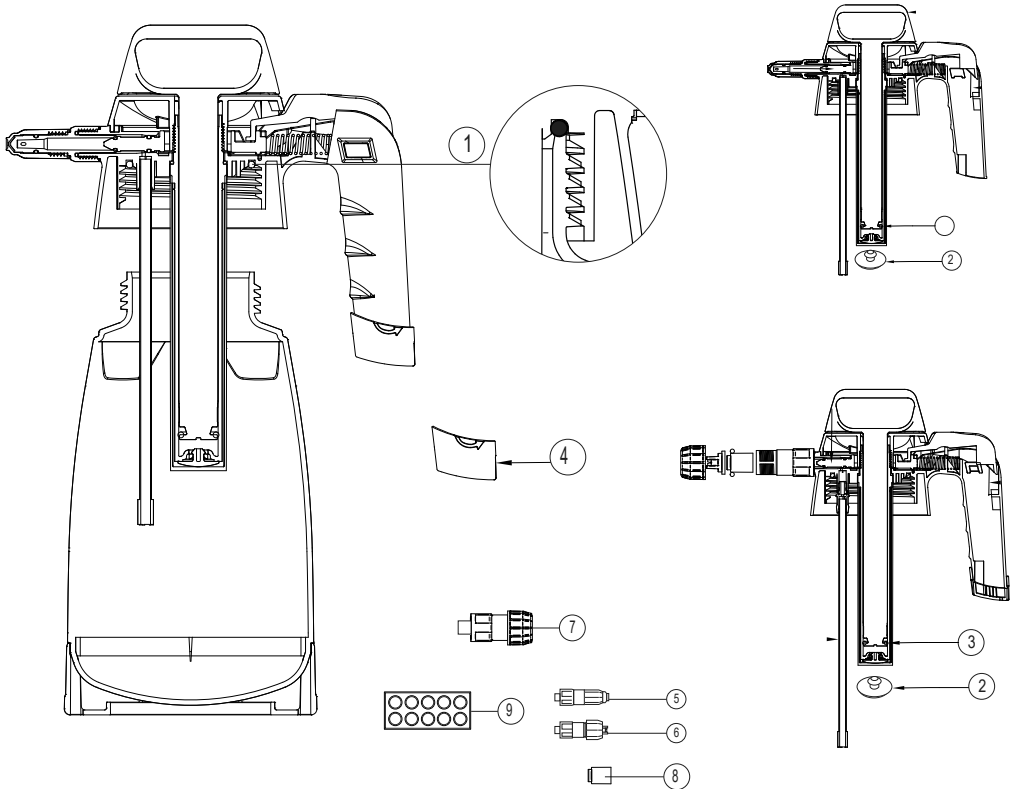

NO.	DESCRIPTION	Model No.	
1	ROUND GASKET		1
2	CHAMBER VALVE	K16023	
3	ROUND GASKET (Ø15)		
4	SPRAYER IDENTIFICATION KIT	K16024	1
5	M-12 ADAPTER WITH ADJUSTABLE CONICAL NOZZLE (K16021 ONLY)		1
6	M-18 ADAPTER WITH FAN NOZZLE (K16020 ONLY)	K16020-1	1
7	COMPLETE ADAPTER (K16021 ONLY)	Not available	1
8	COMPLETE FELT HOLDER (K16021 ONLY)	Not available	1
9	FILTERS (10pcs) (K16021 ONLY)	Not available	1
10	REPLACEMENT NOZZLE KIT (K16021 ONLY)	K16021-1	1
Not Shown	SPRAYER LANCE 13.5cm (K16020)	K16025	1

KINCROME

www.kincrome.com.au

Distributed by Kincrome Tools and Equipment
www.kincrome.com.au
3 Lakeview Drive Scoresby Victoria
Phone: +61 3 9730 7100



Warranty given by Kincrome Australia Pty Ltd of 3 Lakeview Drive, Caribbean Park, Scoresby, Victoria (+61 3 9730 7100). The applicable warranty period (12 months) commences on the date that the product is purchased. If this product has materials or workmanship defects (other than defects caused by abnormal or non warranted use) you can, at your cost, send the product to place of purchase, an authorised Kincrome service agent or one of Kincromes addresses for repair or replacement. Your rights under this warranty are in addition to any other rights you have under the Australian Consumer Law or other applicable laws. Our goods come with guarantees that cannot be excluded under the Australian Consumer Law. You are entitled to a replacement or refund for a major failure and compensation for any other reasonably foreseeable loss or damage. You are also entitled to have the goods repaired or replaced if the goods fail to be of acceptable quality and the failure does not amount to a major failure. For further details please visit www.kincrome.com.au or call us. Due to minor changes in design or manufacture, the product you purchase may sometimes differ from the one shown on the packaging.