



BENCH DRILL

OPERATOR'S MANUAL



TD0813

Ver: 1.01

TABLE OF CONTENTS

Warranty	2
Introduction	3
Safety Information	3
Product Overview	7
Assembly	8
Operation	17
Maintenance	17
Troubleshooting	19
Parts List	20

LIMITED WARRANTY

Industrial Tool & Machinery Sales (hereinafter referred to as ITMS) will, within twelve (12) months from the original date of purchase, repair or replace any goods found to be defective in materials or workmanship.

This warranty is void if the item has been damaged by accident, neglect, improper service or other causes not arising out of defects in materials or workmanship. This warranty does not apply to machines and/or components which have been altered, changed, or modified in any way, or subjected to overloading or use beyond recommended capacities and specifications. Worn componentry due to normal wear and tear is not a warranty claim. Goods returned defective shall be returned prepaid freight to ITMS or agreed repair agent, which shall be the buyer's sole and exclusive remedy for defective goods. ITMS accepts no additional liability pursuant to this guarantee for the costs of travelling or transportation of the product or parts to and from ITMS or the service agent or dealer, such costs are not included in this warranty.

Our goods come with guarantees which cannot be excluded under the Australian Consumer Law. You are entitled to replacement or refund for a major failure and to compensation for other reasonably foreseeable loss or damage. You are also entitled to have the goods repaired or replaced if the goods fail to be of acceptable quality and the failure does not amount to a major failure.

THE MANUFACTURER RESERVES THE RIGHT TO MAKE IMPROVEMENTS AND MODIFICATIONS TO DESIGN WITHOUT PRIOR NOTICE.

PRODUCTS IMPORTED AND DISTRIBUTED NATIONALLY BY:



INDUSTRIAL TOOL & MACHINERY SALES
18 BUSINESS ST, YATALA QLD 4207
T: 07 3287 1114 E: sales@industrialtool.com.au
F: 07 3287 1115 W: www.itmtools.com.au

INTRODUCTION

Thank you for purchasing this drill press.

This machine has been designed for drilling large or small holes in metal, wood and plastic etc. Before attempting to use this product, please read this manual thoroughly and follow the instructions carefully. In doing so you will ensure the safety of yourself and that of others around you, and you can look forward to your purchase giving you long and satisfactory service.

IMPORTANT

Please read all of the safety and operating instructions carefully before using this product. Please pay particular attention to all sections of these instructions that display warning symbols and notices.



WARNING: THIS SYMBOL IS USED THROUGHOUT THE INSTRUCTIONS WHENEVER THERE IS A RISK OF PERSONAL INJURY. ENSURE THAT THESE WARNINGS ARE READ AND UNDERSTOOD AT ALL TIMES.

GENERAL SAFETY RULES



WARNING: WHEN USING ELECTRIC TOOLS, BASIC SAFETY PRECAUTIONS SHOULD ALWAYS BE FOLLOWED TO REDUCE THE RISK OF FIRE, ELECTRIC SHOCK AND PERSONAL INJURY INCLUDING THE FOLLOWING. READ ALL THESE INSTRUCTIONS BEFORE ATTEMPTING TO OPERATE THIS PRODUCT AND SAVE THESE INSTRUCTIONS FOR FUTURE REFERENCE.

GENERAL SAFETY IN THE WORKPLACE

1. ALWAYS ensure that air can circulate around the machine and that the air vents are unobstructed.
2. ALWAYS keep work area clean & tidy. Cluttered work areas and benches invite accidents.
3. NEVER over-reach. Keep proper footing and balance at all times.
4. NEVER store equipment in a wet/damp environment or expose to rain.
5. KEEP other people (especially children) that are not involved in the work, away from the tool or extension cable and keep them away from the work area.
6. NEVER operate a machine when under the influence of alcohol, drugs or medication.

7. ALWAYS ensure the workplace is well lit. Ensure that lighting is placed so that you will not be working in your own shadow.
8. Do not use tools in the presence of flammable liquids or gasses.
9. Stay alert, watch what you are doing, use common sense and do not operate the tool when you are tired.

CARE OF POWER TOOLS

1. Read this manual carefully and understand the machines applications and limitations as well as the specific potential hazards relevant to it.
2. ALWAYS keep guards in place and in working order. A guard or other part that is damaged should be properly repaired or replaced by an authorized service agent, unless otherwise indicated in this instruction manual.
3. Remove any adjusting keys or wrenches before starting. Form the habit of checking to ensure that keys, wrenches and tools are removed from the machine.
4. Don't force the machine and use the correct tool. It will do the job better and safer, at the rate for which it was intended.
5. ALWAYS disconnect the machine from the power supply before carrying out any servicing or changing any accessories.
6. Before further use of the tool, it should be carefully checked to determine that it will operate properly and perform its intended function. Check for alignment of moving parts, binding of moving parts, breakage of parts, mounting or other condition that may affect its operation.
7. Have defective switches repaired by an authorized service agent. Do not use a tool if the switch does not turn it on and off.
8. ALWAYS check for any damage or any condition that could affect the operation of the machine. Damaged parts should be properly repaired.
9. NEVER remove the cover panel unless the machine is disconnected from the power supply, and never use the machine with cover panels removed.
10. Have your tool repaired by a qualified person. This tool complies with the relevant safety rules. Repairs should only be carried out by qualified persons using original spare parts, otherwise this may result in considerable danger to the user.
11. NEVER use this product for any other purpose than that described in this booklet.
12. NEVER abuse the power cable by yanking the cable to disconnect it from the socket. Keep the cable away from heat, oil or sharp edges.
13. Guard against electric shock. Avoid body contact with earthed or grounded surfaces.
14. If the tool should be used outdoors, use only extension cables intended for outdoor use and marked accordingly.
15. Avoid accidental starting by making sure the power switch is off before plugging in the power cable.

ADDITIONAL SAFETY RULES FOR DRILL PRESSES



CAUTION: AS WITH ALL MACHINERY, THERE ARE CERTAIN HAZARDS INVOLVED WITH THEIR OPERATION AND USE. EXERCISING RESPECT AND CAUTION WILL CONSIDERABLY LESSEN THE RISK OF PERSONAL INJURY. HOWEVER, IF NORMAL SAFETY PRECAUTIONS ARE OVERLOOKED, OR IGNORED, PERSONAL INJURY TO THE OPERATOR, OR DAMAGE TO PROPERTY MAY RESULT.

1. **IMPORTANT:** You should not operate this machine unless you are thoroughly familiar with drilling machines and drilling techniques. If there is any doubt whatsoever you should consult a qualified person.
2. **NEVER** operate the machine until it is completely assembled and you have read and understood this entire manual.
3. **ALWAYS** use clamps or a drill vice bolted to the table, to hold the work. It should never be held with bare hands.
4. **ALWAYS** shut off the power & remove drill bit before leaving the machine.
5. **ALWAYS** make all adjustments with the power off.
6. **ALWAYS** use the correct drilling speeds for the drill size and the type of material being drilled.
7. **NEVER** leave the drill unattended whilst it is running. Turn the machine OFF and do not leave until it has come to a complete stop.
8. **ALWAYS** remove and store the drill bits when you have finished work.
9. **NEVER** attempt to drill into a workpiece that does not have a flat surface unless a suitable support is used.
10. **ALWAYS** stop the drill before removing workpieces, work supports or swarf from the table.
11. Keep drills sharp and clean for best and safest performance. Follow instructions for changing accessories.
12. Adjust the table or depth stop to avoid drilling into the table surface.
13. **ALWAYS** be sure that the drill bit is securely locked in the chuck.
14. **NEVER** assemble or set up any work on the table while the drill is running.
15. **ALWAYS** ensure the table lock is tight before starting the drill.
16. Keep handles dry, clean and free from oil and grease.
17. **ALWAYS** keep hands and fingers away from the drill bit.



WARNING: DUST GENERATED FROM CERTAIN MATERIALS CAN BE HAZARDOUS TO YOUR HEALTH. ALWAYS OPERATE THE DRILL IN A WELL-VENTILATED AREA. USE A DUST COLLECTION SYSTEM IF POSSIBLE.

WARNING: THE USE OF ANY ACCESSORY OR ATTACHMENT OTHER THAN ONE RECOMMENDED IN THIS INSTRUCTION MANUAL MAY PRESENT A RISK OF PERSONAL INJURY.

PROTECTIVE CLOTHING

1. Dress properly, loose clothing or other jewellery may get caught in moving parts. Non-slip footwear is recommended.
2. ALWAYS wear safety glasses. (Everyday glasses are not safety glasses.)
3. Wear a face mask if drilling into any material which produces dust.

ELECTRICAL CONNECTIONS



WARNING! Read these electrical safety instructions thoroughly before connecting the product to the mains supply.

Before switching the product on, make sure that the voltage of your electricity supply is the same as that indicated on the rating plate. Connecting it to any other power source may cause damage.

This product may be fitted with a non-rewireable plug. If it is necessary to change the fuse in the plug, the fuse cover must be refitted. If the fuse cover becomes lost or damaged, the plug must not be used until a suitable replacement is obtained.

If the plug has to be changed because it is not suitable for your socket or due to damage, it should be cut off and a replacement fitted by a qualified electrician. The old plug must be disposed of safely as insertion into a mains socket could cause an electrical hazard.

PRODUCT OVERVIEW

BENCH TYPE DRILL PRESS

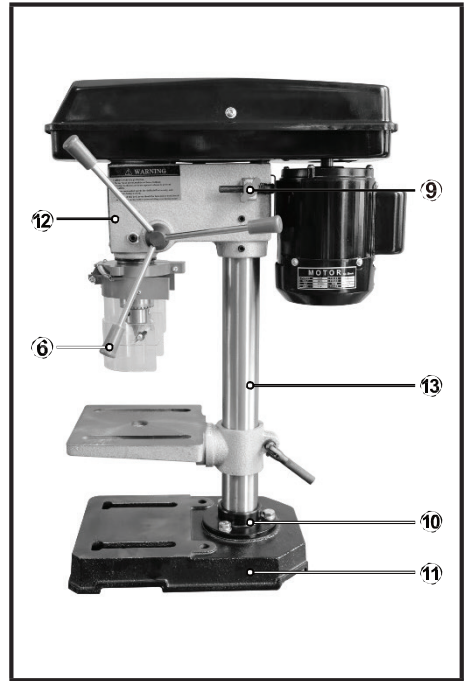
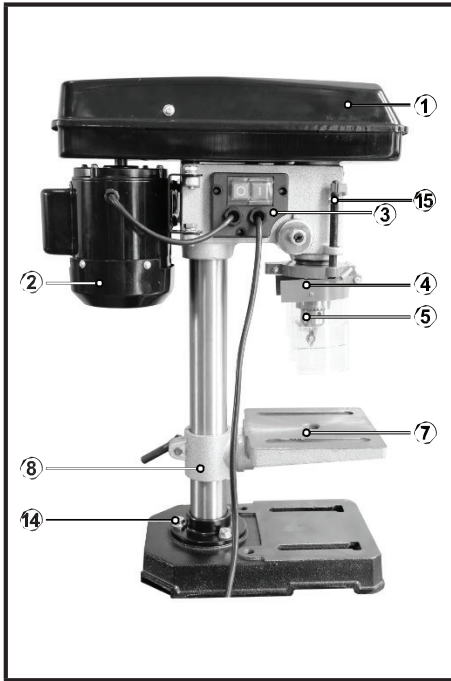

①	Pulley Cover	⑦	Table	⑬	Column
②	Motor	⑧	Table Holder	⑭	Bolts
③	Switch	⑨	Belt Tension Lock knob	⑮	Depth Stop Lock Nuts
④	Chuck guard	⑩	Column Support		
⑤	Chuck	⑪	Base		
⑥	Feed Handle	⑫	Main Housing		

UNPACKING

The drill press is delivered with the components shown on previous page, check the parts against the above list. Should there be any deficiencies or damage you should contact your dealer immediately where the product was originally purchased. Do not discard the packaging until the machine is assembled. The packaging consists of cardboard and appropriately marked materials which can be sent to a re-cycling facility.

To protect the machine parts from moisture, a protective coating of light machine oil will have been applied to the outside surfaces. Remove any excess with a paper towel.

Take care when lifting the head assembly, considering its weight.

Before use, the machine must be mounted, and securely bolted to a strong, heavy workbench of sufficient height that you will be standing upright when working.

Ensure the work place is adequately lit, and that you will not be working in your own shadow.

ASSEMBLY



WARNING! During assembly ensure the drill press is disconnected from the power supply.

Carefully remove contents from the packing box.

Select a firm, level surface on which to assemble the drill press.

BASE & COLUMN

1. Select the base (Fig. 1) and align the column support over the large hole (Fig. 2).
2. Align the holes in the column support with those in the base and secure in place using the bolts and washers. Using a spanner securely tighten all bolts (Fig. 3).
3. We recommend mounting the base to stable surface for proper support.
4. Slide the column into the column support (Fig.4).

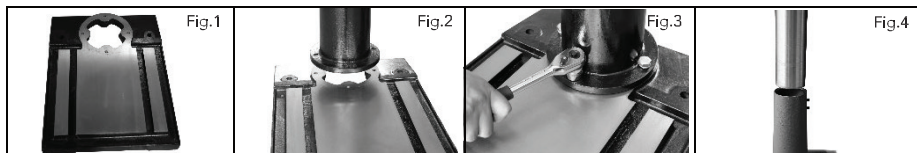

5. Secure in place with 2 grub screws using the hex key (Fig. 5).

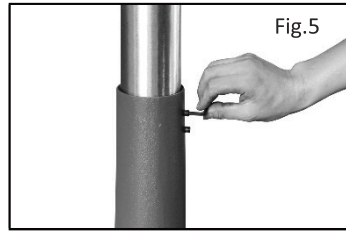

RACK & TABLE

1. Install the rack into the table support as shown (Fig. 6).

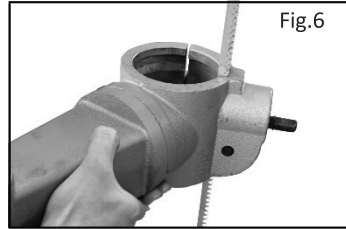

2. Assemble the support and rack onto the column, ensuring the rack is positioned on the right side of the column (when viewing the product from the front) (Fig. 7).

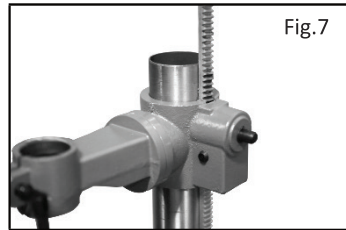

3. Slide the rack all the way down until it locates into the lower column support (Fig. 8). Slide the collar, tapered side facing down, over the column until it locates the rack. Tighten the grub screw on upper collar (Fig.9).



4. Fix table adjustment handle on the support (Fig. 10).



5. Assemble table onto table support, tighten in place with table lock (Fig. 11).



MAIN HOUSING

1. Lift the main housing and slide it down onto the column as far as it will go (Fig. 12). Before securing the housing, ensure the spindle aligns with the table and base.

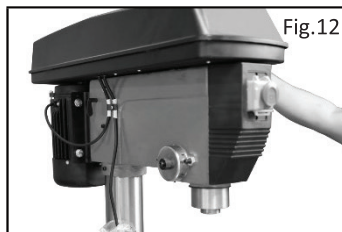

2. To secure in position tighten the grub screws on the left and right hand sides of the housing (Fig. 13).

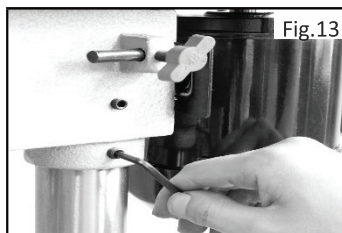

3. To fit the feed wheel handles, screw them into feed wheel hub (Fig. 14).



4. For some cast iron feed handle, tighten the 3 grub screws to wheel hub (Fig.15) then fix the plastic case on cast iron feed handle as shown Fig. 16.

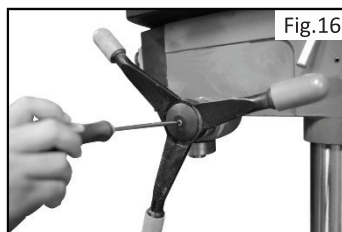

CHUCK & ARBOR

1. Before any assembly, ensure the chuck jaws are wound all the way up (inside the chuck) to prevent them from damage (Fig. 17).

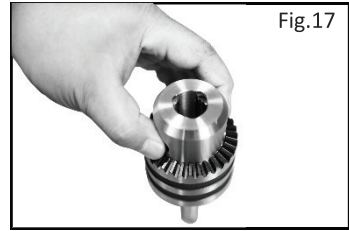

2. Tighten Philip's head screws of the chuck guard to quill shaft (Fig. 18).

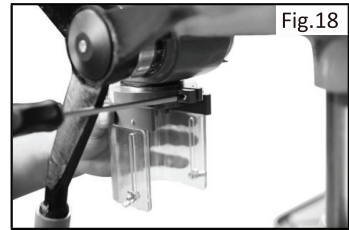

3. Fit the tapered arbor end into the chuck by hand, using reasonable fore (Fig. 19).

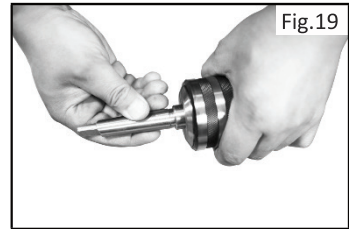

4. The arbor can then be inserted into the quill, twisting the arbor as you insert, aligning the tang into the slot. It should fit in with little resistance (Fig. 20).

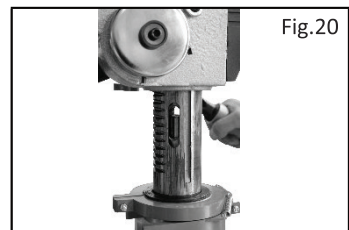

5. Once it is located a firm tap on the underside of the chuck with a soft hammer is required to secure it. The chuck & arbor are installed correctly if they cannot be pulley out with hand force (Fig. 21).



SETTINGS AND AJUSTEMENTS



WARNING! During settings and adjustments ensure the drill press is disconnected from the power supply.

TABLE HEIGHT ADJUSTMENT

1. Loosen the table support lock (Fig. 22).

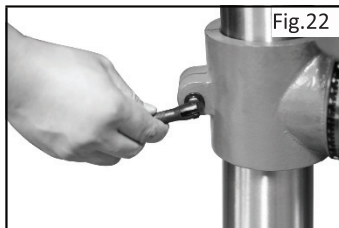

2. Rotate the table adjustment handle to set the desired table height and tighten the table rock to secure the table in position (Fig. 23).

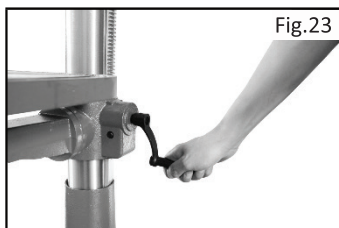

TABEL BEVEL ADJUSTMENT

1. The bevel angel is adjusted by loosening the bolt that is located underneath table support with a spanner (Fig. 24).



2. After tilting the working table (Fig. 25) to appropriate position, re-tighten the bolt to secure its position.

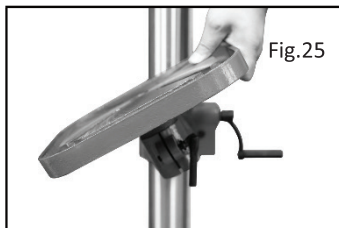

CAUTION: When the table is angled/tilted, ensure the workpiece is clamped to the table.

INSTALLING STRAIGHT SHANK DRILL BITS



1. Using the chuck key, loosen the jaws of the chuck by rotating in an anti-clockwise direction (Fig. 26).



Fig.26

2. Insert the drill bit into the chuck (Fig. 27).

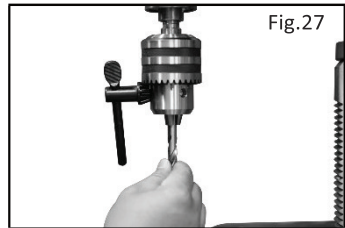

Fig.27

3. Whilst holding the drill bit in one hand rotate the top collar of the chuck in a clockwise direction. Insert the chuck key into 1 of the 3 rotating holes and tighten until drill bit is secure (Fig. 28).

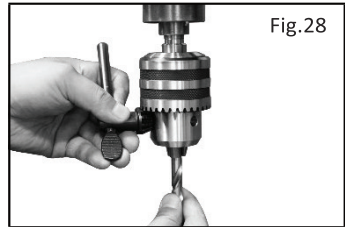
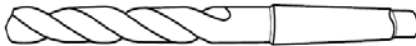

Fig.28

MORSE TAPER DRILL BITS



To use Morse taper bits, remove chuck and arbor.

1. Turn arbor until the tang aligns with the slot in the quill (Fig. 29).

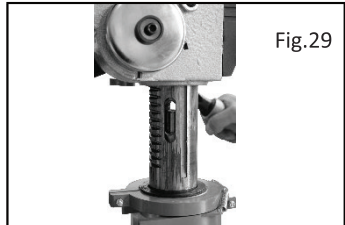
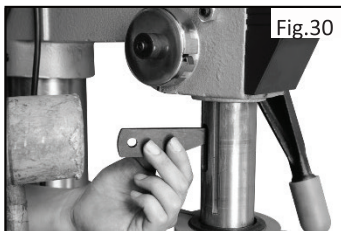
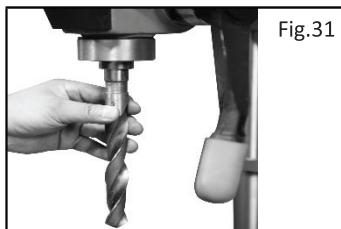

Fig.29

2. Insert the drift key into the slot and tap firmly with a metal hammer until it releases. (Ensure the chuck jaws are wound all the way up to prevent damage (Fig. 30).



3. Place taper bit into the spindle hole, twisting and pushing upward until bit is snug (Fig. 31).



4. Place block of wood on the table and raise up table until the tapered bit is firmly into the spindle.

PRE-SETTING THE DRILLING DEPTH

BENCH TYPE

To set the depth of the hole, adjust the depth stop as follows:

1. Lower the chuck with the power OFF, until the drill bit touches the surface of the workpiece, and hold in that position.
2. Spin down the adjuster nut so that the gap between its underside and top of bracket is the depth of the hole required. Screw down the lock nut and lock it against the adjuster nut.

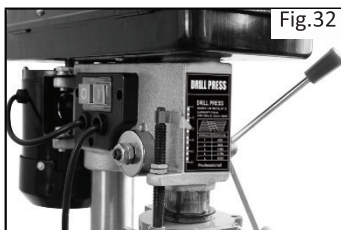

The drill is now set to drill holes to your pre-determined depth from that particular start point. i.e. Providing the surface of your workpiece is flat and level, you may drill a series of holes, each to the same depth.

The scale and pointer can be used when drilling individual holes.

Lower the chuck until the drill bit touches the work, set the pointer against a point on the scale, and proceed to drill to the required depth, using the scale.

FLOOR TYPE

To stop spindle (and bit) at a desired depth:

1. Loosen depth stop lock knob by turning in an anti-clockwise direction (Fig. 33).
2. Rotate depth scale to the desired depth, then tighten half wing bolt (Fig. 34).



To hold the spindle (and bit) at a desired depth:

1. Loosen depth stop lock knob, turn feed wheel handle to lowest point (Fig.35).
2. Rotate depth scale to desired depth and re-tighten depth stop lock knob. This will hold assembly stationary at desired depth.



CHANGING THE SPEED

BENCH TYPE

Before changing the speeds, ensure the machine is switched OFF, and disconnected from the power supply.

1. Open the pulley cover.
2. Slacken off the belt tension locking knob, to relieve any tension on the drive belt.
3. Consult the chart inside the pulley cover, and position the belt on the pulley's according to the spindle speed required.
4. When the belt has been correctly positioned, re-tension by levering the motor away from the head. Lever the motor with its bracket, away from the head, so that tension is applied to the belt. Tension is correct when the belt deflects by approx. $\frac{1}{2}$ " at its center, when using reasonable thumb pressure. Lock the motor in this position using the locking knob.

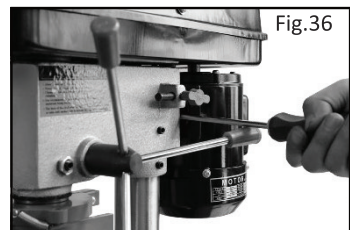

FLOOR TYPE

The speed of the drill press can be changed by adjusting the belt on the pulley system. See chart inside pulley cover for speed configurations.

1. Release the belt tension locking knobs located on either side of the main housing (Fig.37).

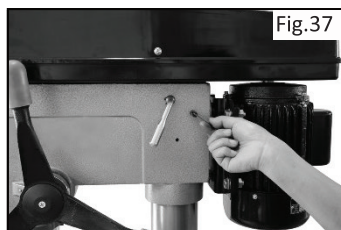

2. Once the tension is released, the belt tension handle can be used to move the motor pulley closer to the idler pulley (Fig.38).

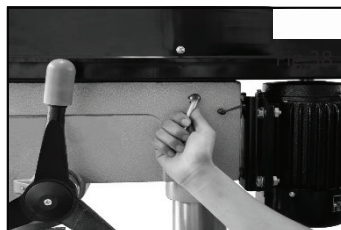

3. The belt is removed by lifting it over the lip of the pulley while rotating the pulley simultaneously (Fig.39).



4. After re-adjusting the belts, use the belt tension handle to move the motor pulley further away from the idler pulley. When the desired position is achieved use the locking knobs to secure the pulleys in place (Fig.40)

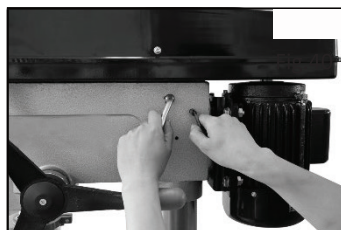

5. Proper belt tension is achieved when the measured deflection (by pushing in the centre of the belt) is approx. 5mm (Fig. 41).

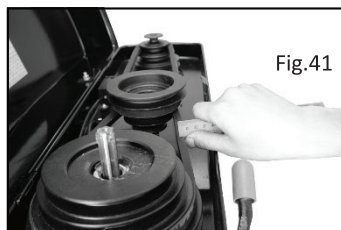

OPERATION

TURNING ON AND OFF

Note: The pulley cover must be closed to operate the drill press.

1. Switch the drill press on by pressing the green(I)button on the switch (Fig.42-43).
2. Switch the drill press Off by pressing the red(O)button on the switch.
3. Secure your workpiece to the table if possible, use a vice or clamps.

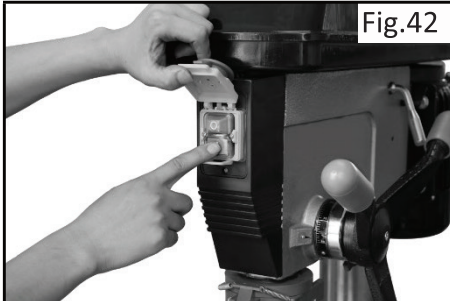

Fig.42

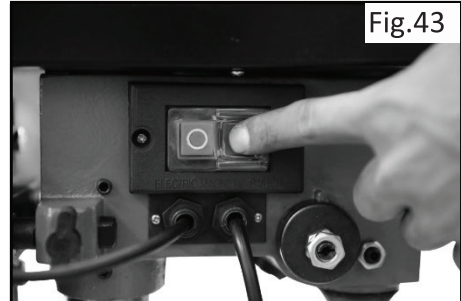

Fig.43

DRILLING

1. Ensure the drill press is switched off and disconnected from the power supply.
2. Loosen the jaws of the chuck with the chuck key by turning in an anti-clockwise direction and insert the selected drill bit into the as far as it will go.
3. Insert the chuck key into 1 of the 3 locating holes and tighten until drill bit is secure.
4. Select your drilling depth and secure the depth stop lock knob in position.
5. Adjust the table to your desired position.
6. Slowly rotate the feed wheel handles to bring the drill bit down towards the table and into your workpiece. After drilling a hole, release the feed wheel handles slowly to return the chuck to its original position.
7. Continue the operation until the task is completed. When completed, switch the drill press Off by pressing the red (O) button on the switch.

MAINTENANCE

For maximum performance, it is essential that the Drill Press is properly maintained. Always inspect it before use. Any damage should be repaired, and faults rectified. Always remove the plug from the power supply before carrying out any adjustment, servicing or maintenance.

Please refer to the trouble shooting chart on pages down. If you are unable to rectify any faults, please contact your local dealer for assistance.

MONTHLY (IF IN REGULAR USE)

1. Check tightness of mounting bolts, and head and column securing set screws.
 2. Check the drive belt for wear, and replace if frayed or damaged.
 3. Blow out with compressed air, or vacuum clean out, any dust that may have accumulated in the motor fan vents.
 4. Apply a thin coat of wax paste or light oil to the table and column, for lubrication, and to help prevent corrosion.
- If the mains lead is damaged in any way, it should be replaced immediately.

LUBRICATION

All bearings are packed with grease at the factory and require no further lubrication.

Occasionally, lubricate the quill shaft assembly and rack with light oil if required.



AFTER USE

Remove all swarf from the machine and thoroughly clean all surfaces.

Components should be kept dry, with machined surfaces lightly oiled.

Always remove drill bits, and store in a safe place.

TROUBLE SHOOTING

PROBLEM	PROBABLE CAUSE	REMEDY
Noisy operation (under load).	a. Incorrect belt tension. b. Dry spindle. c. Loose pulley. d. Loose belt. e. Worn bearing.	a. Adjust tension. b. Remove spindle and quill assembly and lubricate. c. Tighten pulley. d. Adjust belt tension. e. Replace bearing.
Excessive drill wobble.	a. Loose chuck. b. Worn spindle or bearing. c. Worn chuck. d. Bent drill bit.	a. Tighten by pressing chuck down on to a block of wood against the table. b. Replace spindle shaft or bearing. c. Replace chuck. d. Renew drill bit.
Motor won't start.	a. Power supply. b. Motor connection. c. Switch connection faulty. d. Faulty switch. e. Motor windings burned. f. Pulley cover not closed. g. Micro switch on cover not operating.***	a. Check power cord/fuse. b. Check motor connections. c. Check switch connections. d. Replace switch. e. Replace motor. f. Close pulley cover. g. Check operation of micro switch, and renew/adjust as necessary.
Drill binds in workpiece.	a. Excessive feed pressure. b. Loose belt. c. Loose drill. d. Incorrect bit speed. e. Drill angles incorrect for type of material.	a. Apply less pressure. b. Check belt tension. c. Tighten drill with key. d. Adjust the drill speed reasonably. e. Consult a technical manual dealing with materials, drills and cutting angles, and sharpen drill accordingly.
Drill bit burns or smokes.	a. Incorrect speed. b. Swarf isn't discharging. c. Dull drill or not proper clearance for material. d. Needs coolant. e. Excessive feed pressure	a. Adjust drill speed accordingly. b. Clean drill. c. Check sharpness & taper. d. Use coolant whilst drilling. e. Apply less pressure.
Table difficult to raise.	a. Needs lubrication. b. Table lock tightened.	a. Lubricate with light oil. b. Loosen clamp.

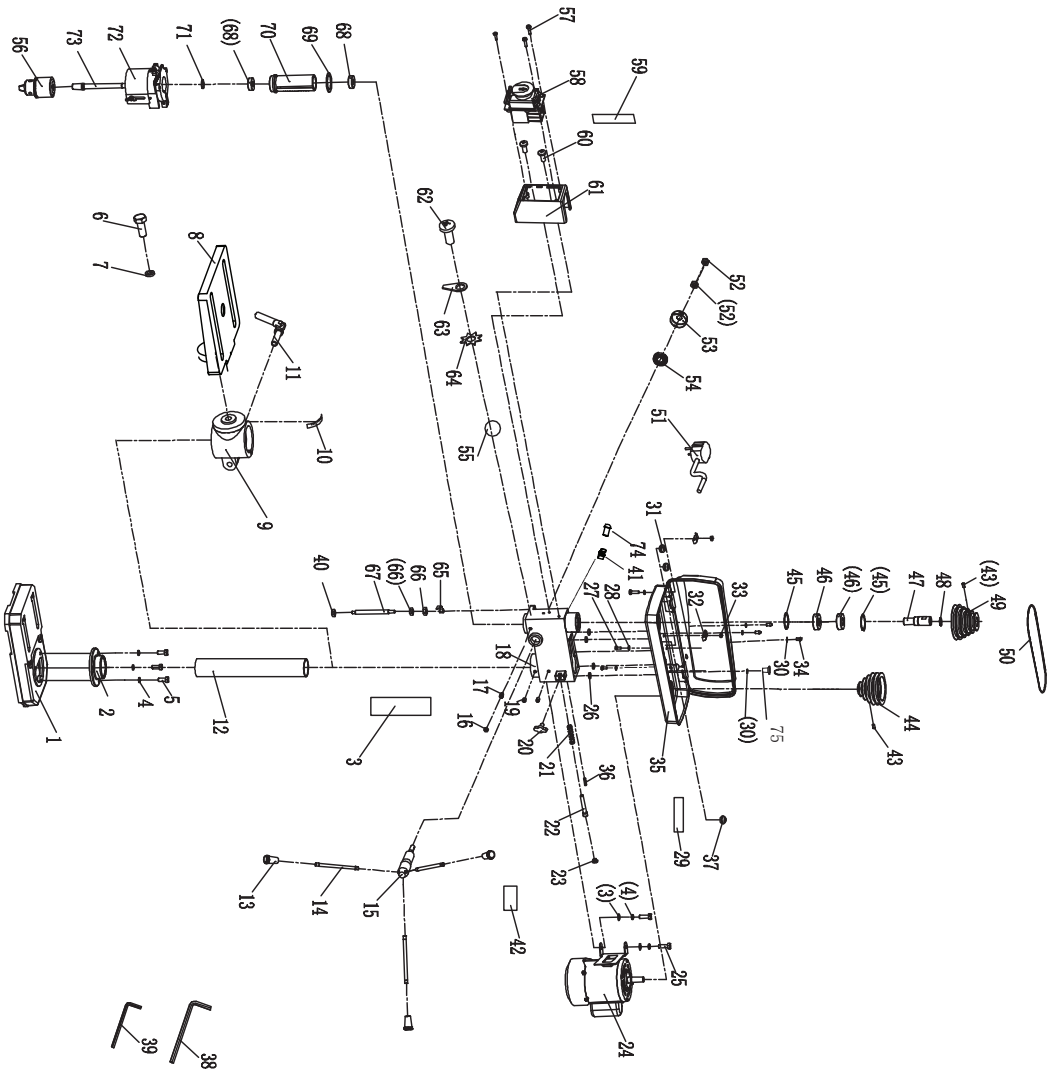

ITEM	DESCRIPTION	SPECIFICATION	Q'TY
1	BASE		1
2	COLUMN FLANGE		1
3	MOTOR LABEL		1
4	SPRING WASHER	8	5
5	OUTSIDE HEX. BOLT	M8x20	3
6	OUTSIDE HEX. BOLT	M12x30	1
7	SPRING WASHER	12	1
8	WORKING TABLE		1
9	TABLE SUPPORT		1
10	ANGLE LABEL		1
11	LOCKING HANDLE		1
12	COLUMN		1
13	HANDLE TIP		3
14	HANDLE		3
15	GEAR SHAFT		1
16	NUT	M8	3
17	FLAT HEAD SCREW	M8X12	1
18	HOUSING		1
19	HEX. SOC SET SCREW	M8x8	2
20	WING KNOB		1
21	MOTOR SPRING		1
22	MOTOR PUSH ROB		1
23	WASHER		1
24	MOTOR		1
25	OUTSIDE HEX. BOLT	M8x25	2
26	DAMPING WASHER		4
27	CROSS RECESS PAN HD SCREW	M5x16	2
28	FLAT WASHER	5	2
29	SPEED LABEL		1
30	FLAT WASHER	6	6
31	PROTECTOR RING	22	2
32	CORD CLAMP		1
33	NUT	M5	2
34	CROSS RECESSED PAN HEAD SCREW	M6x10	3
35	PULLEY COVER ASSEMBLY		1
36	ROLL PIN	6x18	1
37	PROTECTOR RING	9	1
38	HEXAGON BAR WRENCH	3	1
39	HEXAGON BAR WRENCH	4	1

ITEM	DESCRIPTION	SPECIFICATION	Q'TY
40	NUT	M6	1
41	HOOP FOR KEY WRENCH		1
42	WARNING LABEL		1
43	HEX. SOC SET SCREW	M6x10	2
44	MOTOR PULLEY		1
45	CIRCLIP FOR HOLE	40	2
46	BEARING	6203	2
47	KEYWAY SPINDLE		1
48	CIRCLIP FOR BEARING	22	1
49	SPINDLE PULLEY		1
50	BELT	K-630	1
51	PLUG WITH CABLE		1
52	NUT	M10	2
53	SPRING COVER		1
54	SPRING		1
55	LABEL		1
56	CHUCK		1
57	CROSS RECESS HEAD TAPPING SCREW	ST2.9X12	3
58	SWITCH	KJD12	1
59	CALIBRATION LABEL		1
60	CROSS RECESSED PAN HEAD SCREW	M4x10	2
61	SWITCH BOX		1
62	CROSS RECESSED PAN HEAD SCREW	M4x6	1
63	ROUNDED PARTS		1
64	TOOTH LOCK WASHER		1
65	INDICATOR		1
66	NUT	M10	2
67	LIMITED BOLT		1
68	BEARING	6201	2
69	WASHER		1
70	SPINDLE SOCKET		1
71	CIRCLIP FOR BEARING	12	1
72	CHUCK GUARD		1
73	MAIN SPINDLE		1
74	CROSS RECESSED PAN HEAD SCREW	M5x10	1
75	PULLEY COVER TIP		1