





Underground LV Straight Connectors

UST

- Application: Underground Aluminium Conductors
 Voltage: Low Voltage up to 1kV
 Body Material: Aluminium Alloy
 Bolt Material / Type: Aluminium Alloy
 Cable Range: 35 - 300mm²
 Installation Tool: IT-1000-033-AU
 Cable Types:
-  Circular Stranded
 -  Circular Solid
 -  Sector Stranded 4 Core
 -  Sector Solid 4 Core

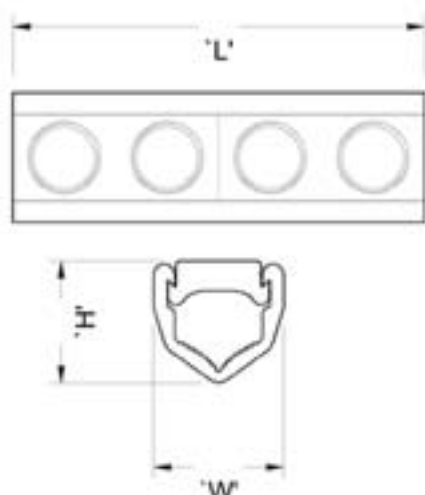
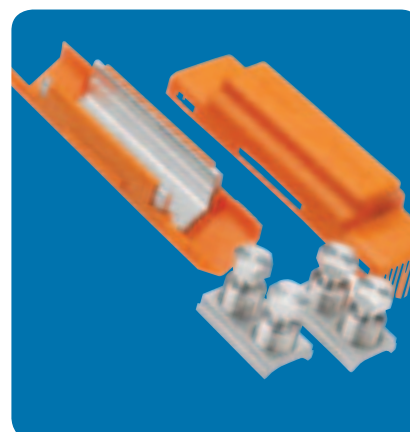

Catalogue Reference	With Shroud	Barrier	Conductor Size Range (mm ²)	Dimensions (mm)			Socket Size (A/F)
				L	H	W	
UST95	UST95INS	no	35 - 95	80	27	26	13
UST185	UST185INS	no	35 - 185	108	33	35	19
UST300	UST300INS	no	70 - 300	108	38	41	19

The moulded orange shrouds offer reliable and robust insulation reducing installation time and making live working easier. Breather holes on the shroud allow 2 and 3 part resins to flow freely and encapsulate the connector and shroud assembly

PROUDLY DISTRIBUTED BY









Web www.gvk.com.au
 Email sales@gvk.com.au
 Phone 03 9312 6633
 Fax 03 9312 6433

Underground Universal LV Branch Joint

UBR

Application: Transition between Different Aluminium Conductors
 Voltage: Low Voltage up to 1kV
 Body Material: Aluminium Alloy
 Bolt Material / Type: Refer to table
 Cable Range: 35 - 400mm²
 Installation Tool: IT-1000-033-AU
 Cable Types:

-  Circular Stranded
-  Circular Solid
-  Sector Stranded 4 Core
-  Sector Solid 4 Core
-  Sector Stranded 3 Core
-  Sector Solid 3 Core

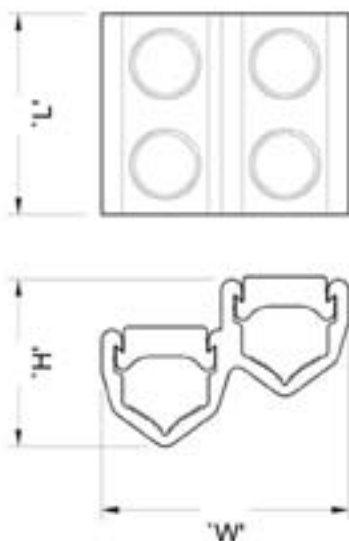
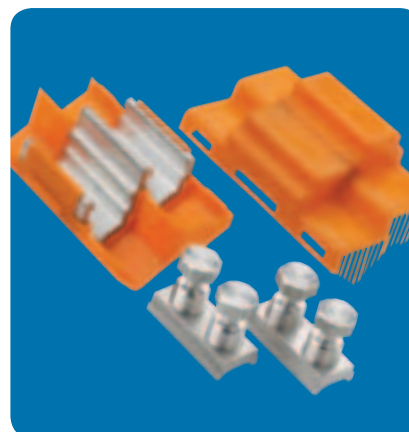

Catalogue Reference	With Shroud	Barrier	Conductor Size Range (mm ²)	Dimensions (mm)			Bolt Material	Socket Size (A/F)
				L	H	W		
UBR95	UBR95INS	no	35 - 95	40	38	50	Aluminium Alloy	13
UBR185	UBR185INS	no	35 - 185	54	47	67	Aluminium Alloy	19
UBR300	UBR300INS	no	70 - 300	54	54	78	Aluminium Alloy	19
UBR400		no	185 - 400	54	62	78	Brass	19

The moulded orange shrouds offer reliable and robust insulation reducing installation time and making live working easier. Breather holes on the shroud allow 2 and 3 part resins to flow freely and encapsulate the connector and shroud assembly.

PROUDLY DISTRIBUTED BY



Web: www.gvk.com.au
 Email: sales@gvk.com.au
 Phone: 03 9312 6633
 Fax: 03 9312 6433