

# COMPLETE INSTRUCTIONS FOR 4-DIE SET LEE DELUXE PISTOL DIES

## CAUTION

Ammunition reloading can be dangerous if done improperly and should not be attempted by persons not willing and able to read and follow instructions exactly. Children should not be permitted to reload ammunition without strict parental supervision. Always wear safety glasses when reloading and shooting. Ammunition loaded with these tools and data should only be used in modern guns in good condition. We do not accept responsibility for ammunition loaded with these tools or data as we have no control over the manufacture and storage of components or the loading procedure and techniques. Primers and gun powders, like gasoline and matches, can be dangerous if improperly handled or misused.

### 1 PREPARE YOUR CASES

Discard cases with defects such as split necks, indications of head separation or anything that would make them unsuitable for reloading.

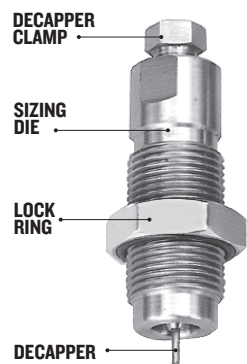

### 2 FULL LENGTH SIZER

Screw the full length sizer in until it touches the shell holder and tighten the lock ring finger tight. The decapper is retained by a collet. Should it be overstressed by an obstruction; it simply slides up without damage. To reset, loosen the decapper clamp and position the decapper flush with clamp end and retighten. Considerable torque may be necessary. A 1/2" and 3/4" wrench are necessary.

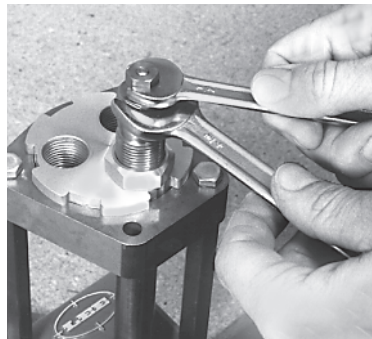

### 3 EXPANDER DIE

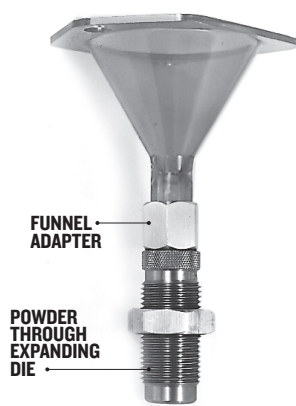

POWDER FUNNEL (NOT INCLUDED)

Screw the die in until it touches the shell holder, then back out one full turn. Finger tighten the lock ring, adjust the flare to your liking; turning inward increases the flare. For maximum case life, flare only enough to easily accept a bullet. In use, the expander plug travels approximately 3/8" within the die and comes to an abrupt stop at extraction. This helps to shake the powder through. However, we recommend you check to be sure all the powder has cleared the funnel and expander plug.

**Be sure to occasionally clean the bullet lube from the expander plug to prevent a powder clog.**

### 4 CHARGE THE CASE



Select a load from the chart on the reverse side. This is the most critical decision you must make. An overcharge can blow up the gun and injure the shooter or persons nearby. It is dangerous to use a bullet of a greater weight with a charge for a lighter bullet. Never select a load intended for a bullet lighter than you are using. Loads for a slightly heavier bullet are safe. Always start with the STARTING LOADS. You may work up to the NEVER EXCEED LOADS gradually, provided you know how to watch for pressure signs. The Lee Dipper is the safest and easiest powder measure to use. For the ultimate in speed, convenience and versatility, consider the Lee Auto-Disk Powder Measure.

### LEE AUTO DISK POWDER MEASURE

The Auto Disk Powder Measure fits into the expanding die in place of the powder funnel adapter. While the case neck is being expanded, the charge is automatically and accurately dispensed. Comes complete with four (4) charge disks and 24 different cavities. It's more accurate than any other measure because of the built-in powder baffle and uniform actuation.

**CAUTION** Never try to seat a primer deeper after powder has been added.

### LEE BULLET FEEDER FOR LEE PROGRESSIVE PRESSES

### 5 BULLET SEATING DIE



Your die set includes the LEE BULLET SEAT AND FEED DIE for use with the Lee Automatic Bullet Feeder. It has a 45° chamfer to allow for the mechanical feed fingers and improved operator clearance. Raise the ram to the top of its stroke and hold. Screw the bullet seating die in until it touches the shell holder, **then back it out three full turns**. Lightly finger tighten the lock ring. Bullet depth is adjusted by screwing the adjusting screw in or out to suit. Bullets should be seated deep enough to work through the gun's action. See MAXIMUM OVERALL LENGTH on charge table. If a crimp is desired, screw the die in slightly and test until the proper crimp is formed. Cases must be trimmed to the same length to provide a uniform crimp. Excessive crimp causes the bullet seater to deform soft nose bullets.

**CAUTION: Seating bullets excessively deep will reduce the case capacity and increase the pressure. It is extremely important that full wadcutter bullets be used with light loads only. You can select these by their reduced velocity.**

The Bullet Seating die is equipped with a floating bullet seating punch for maximum accuracy. It is designed to seat all shapes of bullets with minimum deformation. If you attempt to compress the charge, it may deform the bullet an objectionable amount. It will be necessary to modify the bullet seating punch to fit the bullet. If unable to do it yourself or have it done locally, we can do it for you. Send \$8.00 along with a sample bullet, and order "Custom Seater Plug for Sample Bullet -- \$8"

### 6 CRIMP AND POST SIZE CASES



Screw the Lee Carbide Factory Crimp Die in, until it just touches the shell holder and back out the adjusting screw. With the loaded round in the die, turn the adjusting screw in until you can feel it just touch the case mouth. Then move the cartridge out of the die slightly and screw the adjusting screw in 1/2 turn for a light crimp and one full turn for a heavy crimp. You can adjust for even greater crimp and never have to worry about buckling the case as with conventional crimpers. The case is sized as it enters the die and again as it is pulled out of the die. This assures you every case will freely chamber in any standard gun. Don't expect the carbide sizer to touch every case. It is a fail safe tool for the occasional bad round that could ruin your day.

## LEE BREECH LOCK CHALLENGER PRESS

The "O" frame press by design is the strongest and the most popular style press by far. Large opening and long stroke handles the largest belted magnums with ease. The primer catcher is positive and routes the spent primers directly to the trash can. Priming is a dream with the Lee Lever Prime System. Best of all, it includes the Breech Lock Quick Change Die System. Change dies instantly with a twist of the wrist; you'll never have to re-adjust your die.

Other features include all steel linkage with adjustable length lever. This same press will cost you more than twice as much from other manufacturers, and that's without all of the Challenger's features. If cost is more important than convenience, you can leave the Breech Lock bushing locked in the press and screw dies in and out like any conventional press. 90588

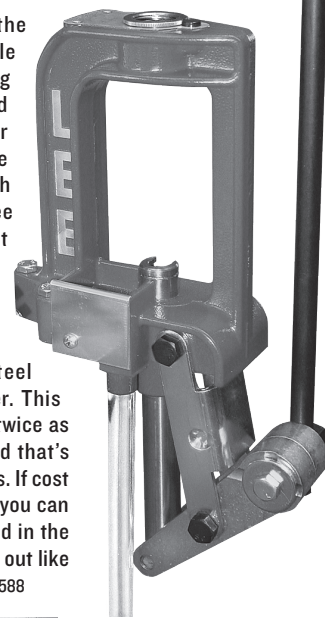

**Change dies instantly with a twist of the wrist; you'll never have to re-adjust your die.**

## LEE CLASSIC TURRET PRESS

### A MACHINE THAT DOES IT ALL

With quality touches that make this press the finest, most convenient press to own. The Classic Turret features the solid steel linkage of the Lee Classic Cast. Your first stroke of the hardwood gripped lever will convince you this is one, solid, silky smooth press!

The rigid cast iron frame supports the ram with over 12 sq. in. of area. The industry's largest ram is drilled completely through to dispose primers in an attached PVC tube. Uses the Lee Lever Prime System · LPS and the Lee Safety Prime tool makes priming on the press a delight. 90064

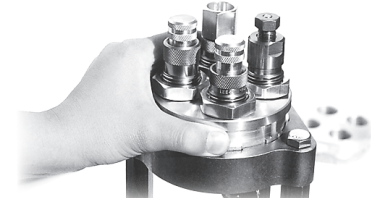
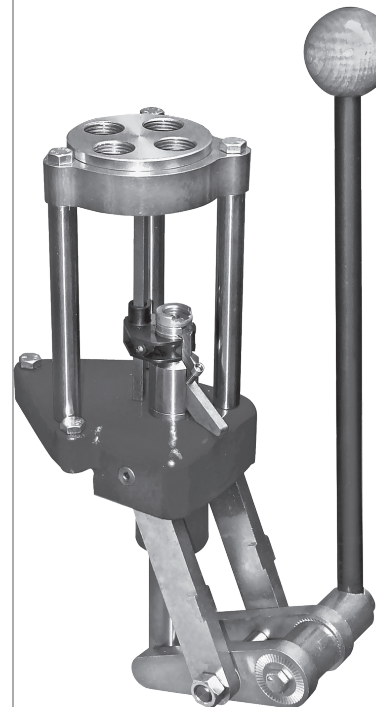

**INSTANT CHANGE TURRETS**  
Lift out the entire turret and replace with the next caliber. Dies, shell holders and primer arm all change in seconds without tools.

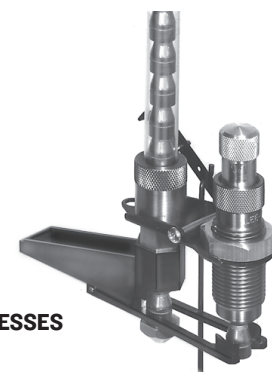

For a complete catalog, send your name and address

**LEE**

LEE PRECISION, INC.  
4275 Hwy. U · Hartford WI 53027  
www.leeprecision.com