

[OPTIONAL]
CASE COLLATOR · 90667

LM3231

COMPLETE INSTRUCTIONS FOR THE

LEE LOAD-MASTER

CASE SLIDER · TR2449
FEED CRANK · LM3259

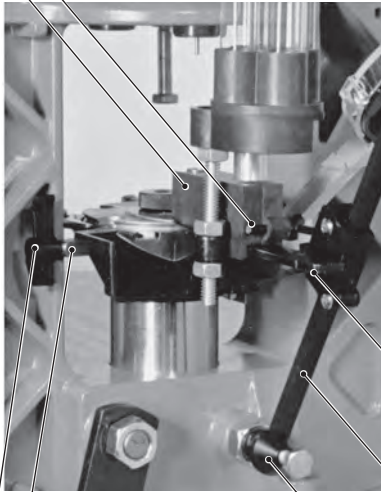

INDEXER · LM3243
INDEXER FLIPPER · LM3244

CRANK SLIDER
with SCREWS

FEED ROD
LM3262

FEED BRACKET
with NUT · LM3260

TURRET LOCK · LM3226

1/4-20 X 1 1/4 with NUT · FL3336

PRIMER WEDGE BAR with SCREW · LM3261

PRIMER ROCKER ARM · LM3239

ROCKER BOLT not visible · LM3227

ROCKER SPRING not visible · TP2115

FRAME · LM3223

WOOD KNOB · TR2447

LEVER · LM3224

SHELL PLATE NUT · REI526

O-RING · REI528

CASE EJECTOR · LM3241

CASE RETAINER · LM3246 4 req.

SHOULDER SCREWS · LM3265 4 req.

BELVILLE WASHERS · LM3263 4 req.

CARRIER · LM3238

RAM · LM3237

INSIDE RAM

SPENT PRIMER DOOR · LM3233

DOOR SPRING · LM1075

SPRING RETAINER · LM3235

DRAW BOLT · LM3242

YOKE · LM3236

YOKE PIN · LM3230

YOKE PIN CLAMP not visible · LM3232

WAVE WASHER · LM3208

7/16 - 20 NUTS · FMI371 · 4 req.

LINK PIN · LM3256

GREASE FITTINGS · LM3248

CONNECTING LINK · LM3229

Helpful setup
and
operation videos
available on
leeprecision.com

The Lee Load-Master is the finest reloading machine ever built. To maximize its usefulness, the instructions should be read and fully understood.

IMPORTANT

YOU MUST DO THESE BEFORE YOU CAN RELOAD

- 1 Bolt to a sturdy bench
- 2 Install case inserter
- 3 Adjust the dies
- 4 Adjust case retainers **VERY IMPORTANT**
- 5 Fill primer feeder with correct primers [See CAUTION, p. 4]
- 6 Adjust primer seating depth
- 7 Attach powder measure and adjust for proper charge
- 8 Fill the powder measure with the correct powder

ALWAYS WEAR SAFETY GLASSES WHEN RELOADING OR SHOOTING

CAUTION

Ammunition reloading can be dangerous if done improperly and should not be attempted by persons not willing and able to read and follow instructions exactly. Children should not be permitted to reload ammunition without strict parental supervision. Always wear safety glasses when reloading and shooting. Ammunition loaded with these tools and data should only be used in modern guns in good condition. We do not accept responsibility for ammunition loaded with these tools or data as we have no control over the manufacture and storage of components or the loading procedure and techniques. Primers and gun powders, like gasoline and matches, can be dangerous if improperly handled or misused. Failure to follow these instructions may result in serious injury or death.

WARNING The greatest danger in reloading is the double charge. Should you be interrupted while reloading, or should anything go wrong, take every possible precaution in making sure no round has received a double charge.

Only CCI or REMINGTON brand primers are safe to use with this tool, unless you have the optional Explosion Deflector.

CAUTION The reloading of rifle ammunition requires extra care. Because of the extremely high pressures of most rifle ammunition, you must be sure your cases are in good condition. Inspect them before each reloading for damage and wear. Cases must be trimmed. An excessively long case will pinch the bullet in the end of the rifle chamber and cause dangerously high pressure that could damage your gun and cause personal injury.

Mounting Your Press

Attach your press to a sturdy workbench with ¼" bolts. Three are required. Mounting distance is the same as the Lee Pro1000 and Turret Press. Screws are not recommended. Be sure that the mounting pads are fully flush with the front edge of your workbench. This insures sufficient clearance for the ram.

It is suggested that ample room be available to the left of the press. This will be your work area and a handy place for your bullets. Only a small area need be kept available to the right of the press for empty cases and loaded rounds.

Case Catcher

As the shell plate is rotated, at the bottom of the stroke, the loaded round is ejected down the chute to the right. The loaded round catcher is held by a special bracket which must be attached to

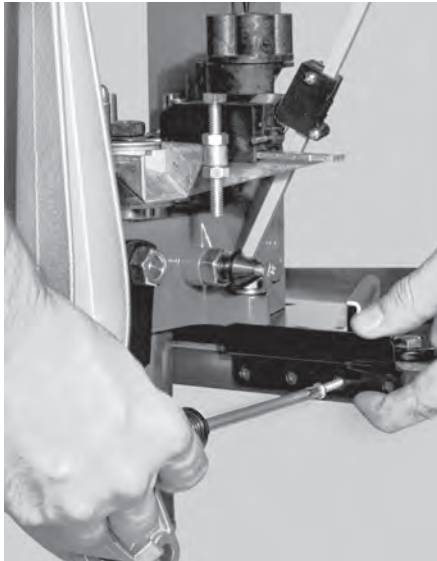

your bench with the screws provided. The left end of the bracket should be parallel with the Load-Master right mounting lug.

Case Inserter

Cases are slid close to the shell plate on the downstroke of the ram and pushed into the shell plate as the ram starts upward. This unique action is achieved with a crank connected to an angled slide with the crank slider. The feed bracket can be easily adjusted in or out as required to fully insert the case. Once set, usually no further adjustment is needed unless you

change from a very large case to an extremely small case.

The following is best performed without primers and the turret not installed.

Insert the round end of the ¼ square shaft into the feed bracket, making sure that it is turned with a flat side square to the press. The crank wire should enter the end hole of the case slider. Tighten the set screw. **Tighten the top screw of the crank slider; use bottom screw to adjust force of shell insertion.**

Cycle press to assure free motion. At the

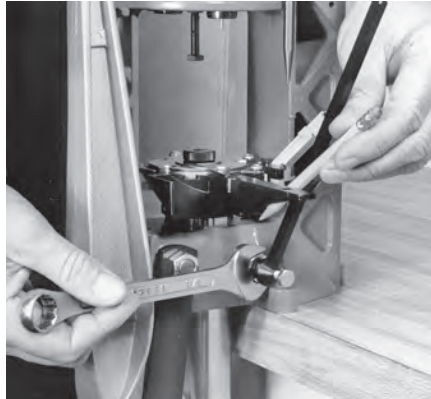

upper most ram travel, place a case in front of the shell slider, cycle lever, again place case in front of slider, cycle lever. If the case collides with the case in shell plate, remove feed rod and unscrew feed bracket one or more full turns. When tightening feed bracket, **be sure to allow 5/16" clearance between carrier tongue and square rod—about the thickness of a pencil.**

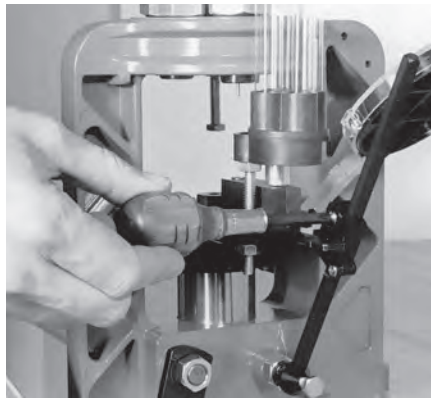

Tighten top screw. Adjust shell insertion pressure with bottom screw.

Do not install 4-tube case feeder until press is set up and tested.

Installing the Lee Auto-Disk Powder Measure

The Lee Deluxe Auto-Disk Powder Measure is an improved version with positive pull back.

The bottom end of the chain should pass through the hole in the carrier. Attach the brass pendant to the chain so the mea-

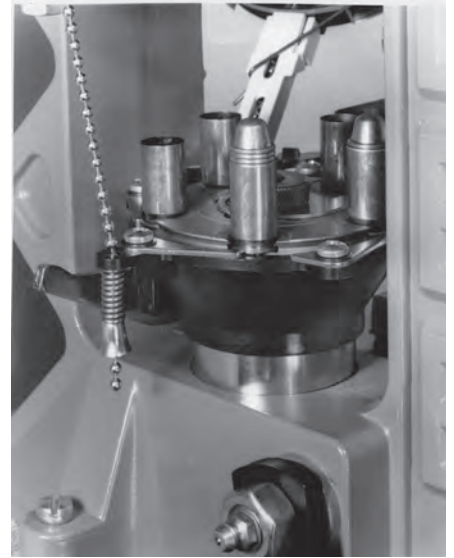

sure is fully retracted when the ram is in the extreme down position. Some chain should dangle below the pendant as the weight helps the chain slide through the carrier hole on each cycle. Fine adjustment is easiest done where the chain attaches to the powder measure. The chain passes through two holes in the lever and it will never move, yet it is easily adjusted. Store the connecting link on the end of the chain. It will be available should you need it for a repair.

Installing the Lee Perfect Powder Measure

The Perfect Powder Measure has been attached to the universal charging die and the proper drop tube is installed. The rest of the set of drop tubes are packed with your press so you may load other calibers.

With a case in the shell plate in station #3, screw the Universal Charging Die and Perfect Powder Measure assembly into the turret until it moves the powder drum to the full dump position (crank down). See details on the Universal Charging Die instructions. The carrier has an extension with a hole for the chain to pass through.

Now lower the ram and attach the pendant to the bead chain with just enough tension to rotate the drum to the fill position (crank up).

It is always important to check the setting of any adjustable powder measure. Normally this is done with a powder scale. If you do not yet have a scale, limit your loading to the charges on the back side of the die instructions. A powder dipper is provided so you can check the charge from your perfect powder measure to double check your setting. The measure, when properly adjusted, will dispense a charge that just fills the dipper. Be sure it is the correct dipper as listed on the Lee load data supplied with the dies.

Preliminary Testing

When you operate the lever you must make complete strokes, stop to stop. Failure to complete the up stroke (lever down) can cause index flipper to put in a “half-cocked” position at mid-stroke and cause press to bind. Continued pressure may damage the ejector pawl. If for whatever reason you short stroke the press, pay attention to the indexer as it pulls out of the carrier at mid-stroke. If you feel it bind — **STOP** — and pull the indexer out manually to the edge of the frame before completing the down stroke.

FIGURE 1

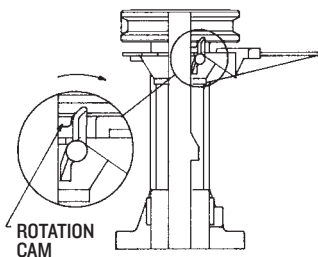

Cycle the lever up and down a few times to get the feel of your machine. As the ram starts up the case slider should move in and then retract. The indexer rod flipper will be turned slightly to the left at mid-stroke and back again at the very top of the stroke. [FIG. 1] About halfway down, the indexer will be pulled toward you by a raised rib and moved to the right by the sloping projection on the frame. [FIGURES 2 AND 3]

Near the bottom of the stroke the lever will push against the indexer and smoothly rotate the shell plate exactly 72°

Always move the ram fully to the stops at both ends of the stroke. Be gentle at the stops. Repeatedly slamming the lever hard against the stops will break something. You have full control of the speed of ram travel and index. While you can go as fast as you like and the machine will not malfunction, going too fast will cause the powder to fling out of your cases while indexing and not permit you to feel when things go wrong. For this reason, we strongly suggest a slow to moderate lever speed. Highest production is achieved with fast lever travel during the mid stroke and learn to slow your travel at both ends of the stroke. Remember that large charges of rifle powder need time to flow, so you must pause sufficiently for all of the powder to enter the case.

One Last Step! Very Important!

At 4 of the 5 loading stations the cases are held in the shell plate with case retainers. The retainers are made to swing out so you can easily remove a case from any position. They must be set so that they hold the case fully into the shell plate. If you push them in too far the case will correctly position them as it passes.

Place a single case in the shell holder and set the case retainers against the case rim in all four stations. The case retainers precisely position the case so that it will be centered to enter the dies and **most important to center over the new primer in the second station.**

Only CCI or Remington brand primers are safe to use with this tool unless you have the optional explosion deflector. Other brands, especially Federal primers, explode with such force that serious injury can occur with their use.

Primer Explosion Deflector 90363
Must be used with all brands of primers other than CCI or Remington.

FIGURE 2

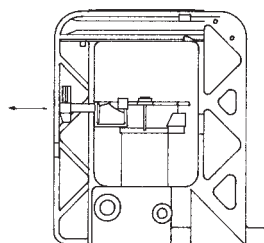
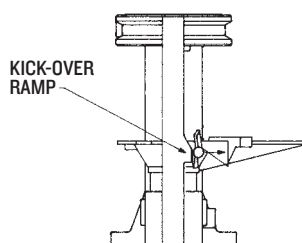

FIGURE 3



Filling the Primer Feeder

Dump only one box of primers into the tray. Only Remington or CCI brand primers are safe to use unless you have installed the optional explosion deflector. Do not use Federal or any brand of primers other than CCI or Remington without the explosion deflector in place.

Gently shake the tray side to side and all of the primers will automatically turn right side up. Replace the cover. Now while holding the primers back with a pencil point or paper clip, attach the tray to the trough. Tap the side of the tray several times to fill the trough. The trough will remain filled while using due to the agitator bumps on the frame. A primer won't feed unless a case is present to push the primer lever back.



Some .45 brass has been discovered with small primers. Please sort your brass accordingly.



Set Primer Depth Adjustment

The 1/4-20 screw that bears against the priming rocker arm may require some fine adjusting to seat primers to your liking. Make very small adjustments and test after each. There is sufficient spring in the linkage to accommodate slight differences in cases.

Operation

Always move the lever fully to the positive stops at both end of lever travel.

Be gentle when you come to the stops to avoid damage. Cases are not perfect and rims may be damaged. It is important to always watch to see that the case fully enters the shell plate.

Always keep the primer trough full with CCI or Remington brand primers. No other brand is safe to use without the optional explosion deflector.

After the fourth stroke of the lever the sized, primed and charged case should be in a position to start the bullet into the case mouth or rest it on the case mouth if you are loading rifle cases.

That's all there is to it. The Lee Load-Master is the nicest press you'll ever use.

WARNING

The greatest danger in reloading is the double charge. Should you be interrupted while reloading or should anything go wrong, go way out of your way to be positive that no round has received a double charge.

Cases can be easily removed from every station by swinging out the case retainer.

Case Feeder

The Lee 4 Tube Magazine Case Feeder and collator are highly desirable options for pistol cases. Attach the cylinder and plate as shown. This assembly should be slightly more than one case length above the carrier tongue. A close adjustment of

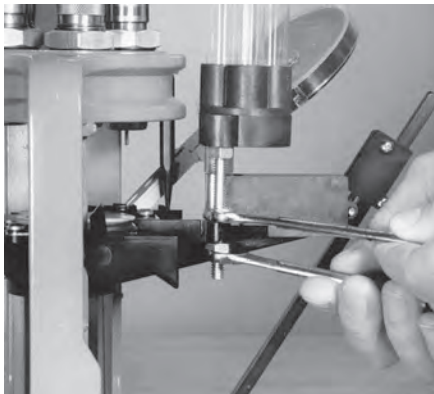

the height will keep cases from tipping. However, it should not be so close that slight case length variances will cause binding. Tighten the lock nuts. **Use two 7/16 wrenches to prevent breaking the bracket.**

No case feeder is available for most rifle cases. Rifle cases should be dropped in front of the case slider at the top of the stroke. It will be automatically inserted into the shell plate after the index is completed.

Keep Your Press Clean

It is especially important to frequently clean out the openings in the shell plate which hold the shell. Dirt or gunpowder will keep the case from fully entering the shell plate. This will cause feeding, priming and alignment problems.

Frequently check the primers to be sure they are seated properly. If dirt falls on the priming punch, it will deface the primer. Unless it is extreme, it will cause no harm. To remove the dirt, depress the primer rocker arm to raise the punch and wipe it clean with your finger.

Empty The Spent Primers

Primers are 100% captured inside the ram. To empty, simply slide the cover back while holding a container under the ram.

Be sure to close the cover, or it will get bent the next time the ram is raised.



Lubrication

The press has been lubricated at the factory. After several thousand rounds of loading, or if the press has set idle for a long time it should be relubricated. Use any automotive type grease in the 3 fittings at the ends of the pins. Grease guns are available in automotive departments of all chain stores for less than ten dollars. Place a small dab of grease on the primer rocker arm where it contacts the bolt head. The

ram should be oiled before every use and it will last forever.

Automotive engine oil is the best. Any kind of oil is better than none. **DO NOT USE WD-40 or dry lubricants.** These do not offer sufficient protection.

A very tiny amount of grease in the center hole of the shell plate and the square indexer rod will greatly extend the life of the carrier and make it work smooth as silk.

Changing The Turret

Changing calibers is quick and easy because of the removable turret. It is precisely aligned with the knurled lock screw on the left. Loosen the screw so the turret can be rotated about 3/8" and lifted out. When replacing, make certain the lock screw engages the groove in the turret.

Changing Calibers

The fastest way to change dies is to have them installed in their own turret. It then becomes very fast and easy to replace the entire turret.

If the shell head is of a different size it is also necessary to replace the shell plate. The shell plates for the Load-Master are the easiest of all to change.

While the shell plate is off, you can change the primer feeder if another size is needed. Remember to change to the proper type of primers — rifle, pistol, regular or magnum.

Changing The Priming Tool

Remove the knurled nut, case ejector, indexer rod and shell plate. Swing the case retainer out of the way. Insert the primer punch into the hexagon-shaped hole in the right rear of the carrier. Be sure the tiny

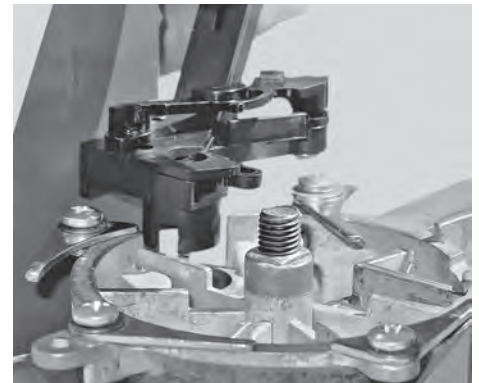

spring is installed into the hole at the rear of the primer punch. Now slip the primer trough over the punch. Push down on the left end of the priming rocker arm to be sure everything is working freely. The primer punch will be seen moving up as you push down on the priming rocker arm.

Changing The Shell Plate

Remove knurled nut case ejector and indexer. Select proper shell plate from chart on the last page. Replace shell plate on carrier you will have to work it under the primer lever.

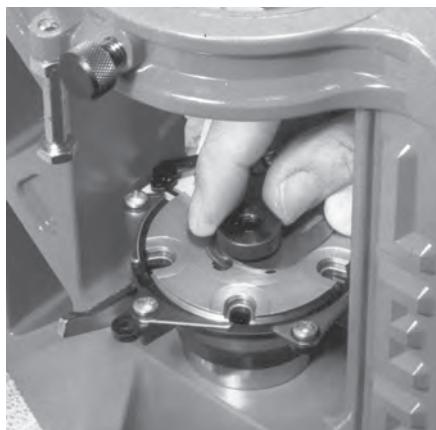

Place case ejector directly on top of the shell plate making sure square on top of center post is engaged and case ejector pointer is towards the chute on the right.

Secure case ejector and shell plate with knurled nut. Be sure "O" ring and groove is toward shell plate. Install indexer with longer portion of flipper pointing upward and beveled side of indexer to your right.

Wedge locking of the shell plate is adjusted by screwing the flipper out for a tighter lock, screw in for a looser lock. Smoothest operation is attained with the wedge lock slightly loose.

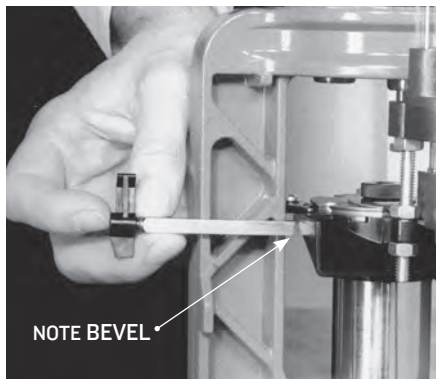

Changing Dies

Specific die installation instructions are not included in this manual. Always follow the instructions included with the dies.

WHEN INSTALLING DIES

- Follow instructions supplied with dies.
- Always install decapping die in station #1.
- Carbide pistol dies should be installed so they just touch the shell plate.
- Dies for rifle bottle neck case must be screwed in until they touch the shell plate plus 1/4 turn.
- Do not use rifle dies that require end of sizing die be kept away from shell plate. They have dangerous capability of producing ammunition with excessive headspace.

Specific Station Requirements

Station 2

This station may not be used to add powder or deprime. A pistol expanding die can be used at this station if it does not deprime or add to the powder.

Station 3

This is the powder charging station. It is strongly recommended that an automatic powder measure be used at this station.

HINT A carbide sizing die with the decapper removed can be placed at this station. This will provide excellent alignment of the case for priming and will alert you if the case retainer moves out of position. Be sure to install a Lee Universal Decapping Die in station #1 or use a larger caliber die to deprime.

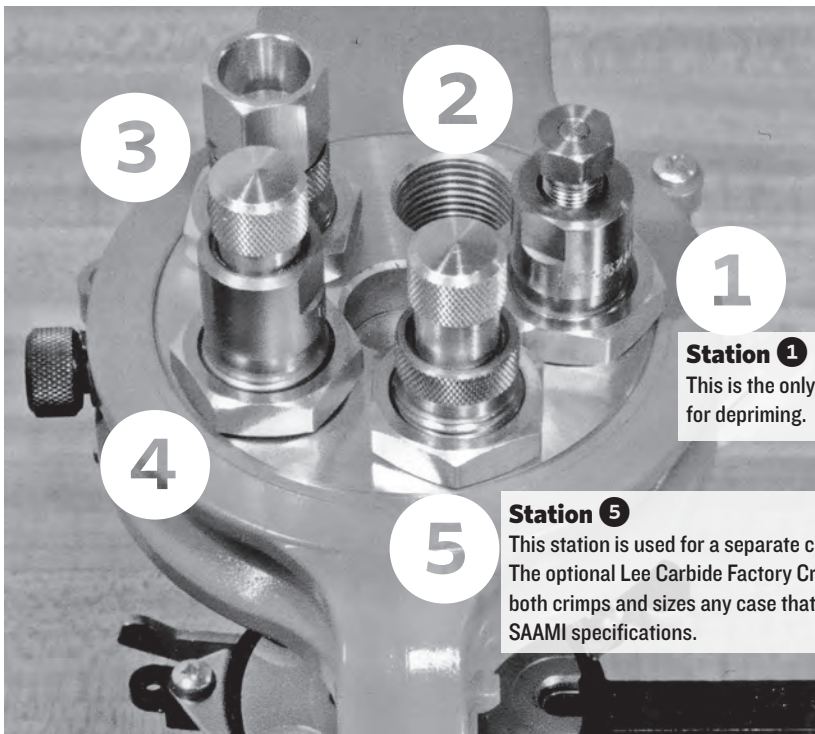

Station 1

This is the only station for depriming.

Station 5

This station is used for a separate crimp die. The optional Lee Carbide Factory Crimp Die both crimps and sizes any case that exceeds SAAMI specifications.

Station 4

This is typically used to seat the bullet.

On pistol cases where the mouth has been flared, the bullet can be started into the case mouth by hand or can be automatically placed with the optional Lee Bullet Feeder.

The die should be adjusted to seat the bullet at the proper depth. Proper depth is achieved when:

- Cartridge overall length is short enough to function through your gun's action.
- The bullet's crimp groove is almost entirely inside the case mouth.

NOTE This is not important if a Lee Factory Crimp Die is to be used at the next station.

- The bullet is not seated deeper than recommended by the charge table.

Alignment of the Carrier to the Turret

This is an adjustment that need never be done unless you disassemble the carrier from the ram.

The draw bolt head, at the bottom of the ram, **MUST** be loosened so the carrier can be rotated on the end of the ram. With the index flipper in the “in position” and the carrier at the pull out rib position, swing the carrier clockwise (viewed from top) until center hub of index flipper contacts the pull-out rib. [FIGURE 4]. Tighten draw bolt securely — 11.6 ft./lbs.

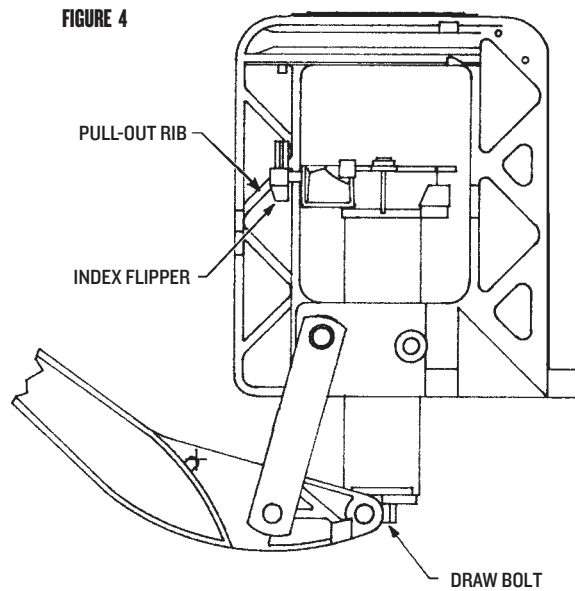

Troubleshooting

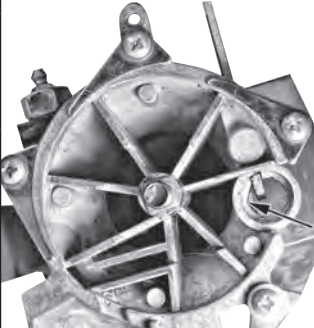
Problem	Possible Cause	Remedy
Primers not fully seated	Lever not lowered to full down stop	Actuate lever to FULL DOWN position
	Die set too deeply to press	Adjust dies to insure carrier can travel to FULL UP position
	Primer rocker arm bolt not properly adjusted	See adjustment procedure in this manual
Tipped primer 	Case retainer out of adjustment	See adjustment procedure in this manual
	Cases not aligned well due to out of tolerance or damaged rim	Install sizing die without decapper in priming station for better alignment. See Changing Dies, Station #2.
	Dirt or gun powder in shell holder grooves	Scrape shell holder grooves with paper clip. Use compressed air to remove debris.
	Tumbling media on primer post or in primer feed	Remove and clean primer feed. Do not process cases with tumbling media lodged in primer flash hole.
Primer does not feed onto primer punch	Oil in trough	Clean oil from trough
	Primer trough not full	Keep primer trough full
Shell plate fails to index	Damaged case ejector pawl	Straighten pawl to prevent excessive clockwise movement of shell plate
	Carrier out of adjustment	See adjustment procedure in this manual
	Indexer improperly installed	See adjustment procedure in this manual

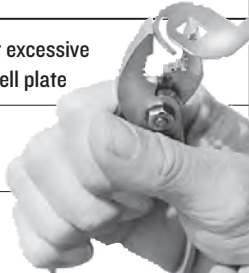

Accessories	Part No.
Large Primer Feeder.....	90077
Small Primer Feeder.....	90075
Shell Plate, specify caliber.....	
Large Case Feeder.....	90658
Small Case Feeder.....	90659
This has a small slider and an extension for short cases	
Rifle Case Feeder.....	90663
This has a reducer bushing to better fit 223 and 30 M1 cases. 30 MI Carbine and other small and short calibers. Rifle cases are best loaded by placing the case in front of the case slider after inspection and lubrication	
Primer Explosion Deflector.....	90363
Must be used with all brands of primers other than CCI or Remington	
5 Hole Turret.....	90079
Bin and Bracket.....	90687
with mounting bracket & screws	
Case Collator.....	90667
fills all four feeder tubes in 10 seconds	
Custom Made Shell Plates	
6 weeks delivery	

Available in over 125 Calibers

All of the combinations listed should work quite well. Because of the assorted shapes of cartridges, some may require slight modifications to the equipment for best results. It simply isn't possible to make, say, a single case inserter, to work perfectly with every size and shape of cartridge. The factory can usually make custom modifications at reasonable costs. Please contact us for your special needs.

Lee Bullet Feeder

Fits directly into the Load-Master. Automatically feeds bullets into the mouth of the seating die. Aligns bullets more accurately than possible by hand. Increases the cyclic rate 50 to 100%.

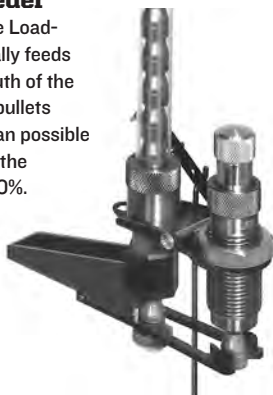

Lee Guarantee

LEE RELOADING PRODUCTS ARE GUARANTEED

not to wear out or break from normal use for two full years, or they will be repaired or replaced at no charge if returned to the factory. Any Lee product of current manufacture, regardless of age or condition, will be reconditioned to new, including a new guarantee, if returned to the factory with payment equal to half the current retail price. ❄

List of Sizes

CARTRIDGE PISTOL	SHELL PLATE	PRIMER SIZE	CASE FEEDER
22 Rem Jet	IS	S	90658
256 Win. Mag	IS	S	90658
30 Luger	19S	S	90659
30 Mauser	19S	S	90659
32 ACP*	7	S	90659
32 Short Colt	4A	S	90659
32 Long Colt	4A	S	90659
32 S&W	4A	S	90659
32 S&W Long	4A	S	90659 w/Large Slider
32 H&R Mag	4A	S	90659 w/Large Slider
32 Colt N.P.	4A	S	90659 w/Large Slider
380 Auto	4S	S	90659
9mm Luger	19S	S	90659
38 S&W	IS	S	90658
38 Colt N.P.	IS	S	90658
38 Super Auto	19S	S	90658
38 ACP	19S	S	90658
38 Short Colt	IS	S	90658
38 Long Colt	IS	S	90658
38 Special	IS	S	90658
357 Magnum	IS	S	90658
40 S&W	19S	S	90658 w/Small Slider
10mm Auto	19L	L	90658
41 Long Colt	IS	L	90658
41 Action EXP	19L	S	None
41 Magnum	9L	L	90658
44 S&W SPL	11L	L	90658
44 S&W Russian	11L	L	90658
44 Magnum	11L	L	90658
44 Auto Mag	2L	L	90658
45 Auto	2L	L	90658
45 Colt	11L	L	90658
455 Webley	5L	L	90658
PPC	12L	S	90658

CARTRIDGE RIFLE	SHELL PLATE	PRIMER SIZE	CASE FEEDER
17 REM	4S	S	90663
22 Hornet	20	S	90663
22K Hornet	7	S	90663
22 Savage	3L	L	
22 BR	2L	S	
218 BEE	6S	S	
219 Zipper	3L	L	
220 Swift	10L	L	
221 Fireball	4S	S	90663
222 REM	4S	S	90663
222 REM Magnum	4S	S	90663
223 (5.56mm)	4S	S	90663
224 Clark (22/257)	2L	S	
225 WIN	10L	L	
22/250	2L	L	
240 Weatherby	2L	L	
243 WIN	2L	L	
6mm REM	2L	L	
244 REM	2L	L	
6mm/284	2L	L	
6mm/06	2L	L	
6x47 (6mm/222M)	4S	S	
25/284	2L	L	
25/06	2L	L	
25/20 WIN	6S	S	
250 Savage	2L	L	
25/35	3L	L	
257 Roberts	2L	L	
257 Weatherby	5L	L	
6.5mm06	2L	L	
6.5mmx57	2L	L	

CARTRIDGE RIFLE	SHELL PLATE	PRIMER SIZE	CASE FEEDER
6.5x55 Mauser	3L	L	
6.5 JAP	10L	L	
6.5 REM Magnum	5L	L	
6.5 Carcano	2L	L	
264 WIN Magnum	5L	L	
270 WIN	2L	L	
270 Weatherby	5L	L	
7mm/08	2L	L	
280 REM	2L	L	
7x57mm Mauser	2L	L	
7x61 Sharpe & Hart	5L	L	
7mm REM Magnum	5L	L	
7mm Weatherby	5L	L	
284 Winchester	2L	L	
7.5mm Schmidt-Rubin	3L	L	
30MI Carbine	7	S	90663
7.62x53 ARG Mauser	3L	L	
7.62mmx39	12L	L	90658
30 Herrett	3L	L	
30/30 WIN (30 W.C.F.)	3L	L	
300 Savage	2L	L	
308 WIN (7.62 NATO)	2L	L	
30/06 Springfield	2L	L	
300 H&H	5L	L	
300 Weatherby	5L	L	
300 WIN Magnum	5L	L	
308 Norma Magnum	5L	L	
7.7 JAP	2L	L	
32 WIN S.L.	3L	L	
32 WIN SPL.	3L	L	
32/20 (32 W.C.F.)	6S	S	
8x57 Mauser	2L	L	
8mm/06	2L	L	
8mm MAN SCHOE.	2L	L	
8mm REM Magnum	5L	L	
33 WIN	8L	L	
338 WIN Magnum	5L	L	
340 Weatherby	5L	L	
348 WIN	8L	L	
35 REM	2L	L	
35 WIN	5L	L	
35 Whelan	2L	L	
350 REM Magnum	5L	L	
358 WIN	2L	L	
358 Norma MAG	5L	L	
375 WIN	3L	L	
375 H&H	5L	L	
375 Weatherby	5L	L	
38/40 WIN	14L	L	
38/55 WIN	3L	L	
40/82 WIN	8L	L	
408 WIN	3L	L	
44/40	14L	L	
444 Marlin	11L	L	
45/70 GOVT	8L	L	
458 WIN Magnum	5L	L	

Most of the above sizes can be made up at the factory if the dies are listed in our catalog. Not all dies listed above are available.

Most pistol calibers come with the Pro Auto-Disk powder measure and a case feeder. Carbide dies when available.

Most rifle calibers come with the Perfect Powder Measure and Universal Charging Die. No case feeder.

*7 may not work with all cases

LEE

LEE PRECISION, INC.
4275 Hwy U · Hartford WI 53027
www.leeprecision.com