

TROUBLESHOOTING

BULLETS NOT BEING PULLED FROM THE STACK

Too many bullets in feed tube	Reduce the number of bullets in feed tube
Nose nesting in hollow base	Select bullets that do not nest together
Bullets too sticky from wax or excessive Alox	Reduce the number of bullets in feed tube or change lube technique
Nylon feed finger sprung open	Boil feed finger for 3 minutes to restore original tension
Worn out buffer	Replace buffer

BULLETS DROPPING OUT TOO SOON

Feed finger sprung open	Boil feed finger for 3 minutes to restore original tension
Wrong feed finger	Be sure correct feed finger is installed Large fingers are marked with 'L' next to gripper

BULLETS TIPPING IN CASE, DAMAGING CASE NECK WHEN USING VERY SHORT BULLETS

Bullet not engaging seater plug properly	Custom bullet seater plug must be made Send sample bullet, name of cartridge and check for \$8.00, plus shipping & handling Request "special seater plug"
--	---

BULLET TIPS WHEN EXITING THE FEED DIE

Spring not installed on top of attach plate over buffer	Be sure spring is installed on damper and that damper operates freely through attach plate
Buffer or action rod linkage binding	
Bullet feed die opening too long	Select bullet feed die with shorter opening



Multi Tube Bullet Feeder 90280

Four tube magazine feeder quickly and easily attaches to the bullet feeder. Kit includes set of four large and small feed tubes, large and small multi-tube adapters and cylinder-plate assembly.

Guarantee

LEE RELOADING PRODUCTS are guaranteed not to wear out or break from normal use for two full years or they will be repaired or replaced at no charge if returned to the factory. Any Lee product of current manufacture, regardless of age or condition, will be reconditioned to new, including a new guarantee, if returned to the factory with payment equal to half the current retail price.

LEE LEE PRECISION, INC.
4275 Hwy. U · Hartford WI 53027
www.leeprecision.com

PRINTED IN USA

LEE BULLET FEEDER INSTRUCTIONS

The Lee Bullet Feeder is a revolutionary accessory, every bit as useful and necessary as an automatic primer feed or powder dispenser. It has been designed to function with the Lee Pro 1000 and Lee Load-Master. Read and follow these instructions to ensure proper operation.

Bullet Feed Die (specify I-7)

Feed Finger, small	BF3415
Feed Finger, large	BF1511
Pivot Bolt	BF1680
Feeder Link	BF2759
Die Plate	BF2977
Tube Adapter	BF3416
BF Spring	BF3421
O-Ring	AD2299
6-32 Hex Nut	FE3505
Instructions	BF3498
Buffer	BF1702
Crank	BF2976
Action Rod	BF3419
Attach Plate	BF3418
Damper	BF3506
8-32 x 3/8 Phillips screw	FP2112
Bullet Feed, body	BF3414
6-32x 1/4 Phillips screw	FL3046
Large Feed Tube	BF3489
Small Feed Tube	BF3490
Return Spring	BF1174

PATENT #5,763,810 EXPIRES 2016

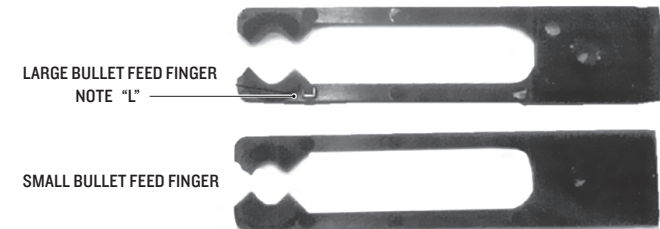
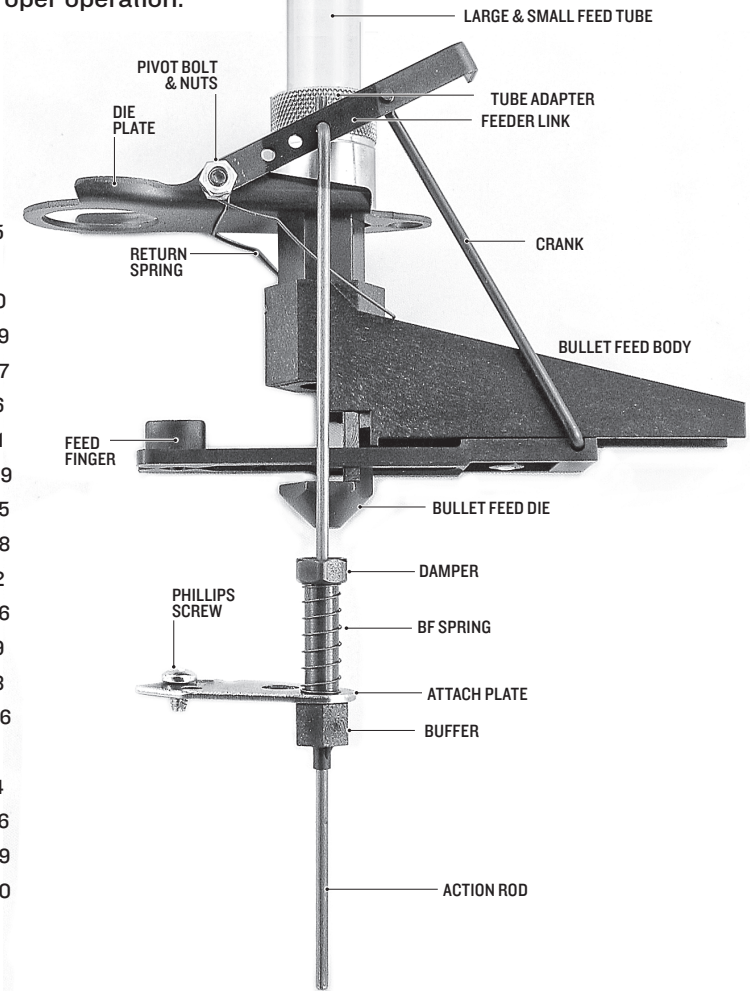

BF3498

LEE LEE PRECISION, INC.
4275 Hwy. U · Hartford WI 53027
www.leeprecision.com

IMPORTANT

This tool must be used with a Lee Bullet Feed and Seat Die. Attempts to use any other die will damage the bullet feeder. This die has a tapered end to release the bullet feed fingers and is shortened to allow space for the fingers while crimping. Latest production Lee Pistol Die Sets include this die. If you have an older Lee Die Set, return your bullet seating die with \$6.00 plus S&H for a new die body.



Start by selecting the correct bullet feed kit for your bullet diameter and length. The feed die opening should be just long enough to freely feed your bullet. Do not select an excessively long feed die as bullet tipping and misfeeds will result. See chart listing for currently available feed dies.

Unusually long, short or oddly shaped bullets may require a special feed die. These are available factory direct at \$20.00 plus S&H. Submit 3 samples of the bullet you wish to feed along with your order. Allow three weeks for delivery.

Feed dies are marked with 3 characters on the end—the first character denotes the die number; the last 2 characters are manufacturing date codes.

BULLET SIZE & LENGTH	FINGER SIZE	FEED TUBE	KIT	FEED DIE & FINGERS
1XX .30 & .32 cal Bullets, up to .60 long	Small feed fingers	small	90892	90885
2XX 9mm through .365 diameter, up to .46 long	Small feed fingers	small	90893	90886
3XX 9mm through .365 diameter, .47 to .60 long	Small feed fingers	small	90894	90887
4XX 9mm through .365 diameter, .61 to .75 long	Small feed fingers	small	90895	90888
5XX .40 cal through .44 caliber up to .65 long	Small or large feed fingers	large	90896	90889
6XX .40 cal through .44 caliber .66 to .80 long	Small or large feed fingers	large	90897	90890
7XX .45 caliber, up to .67 long	Large feed fingers	large	90898	90891

SET UP

- Fasten the attach plate to your press as shown.

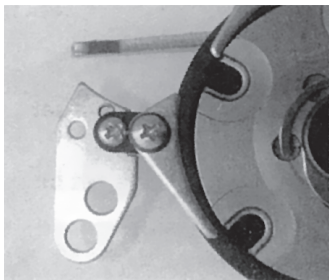

LOAD-MASTER

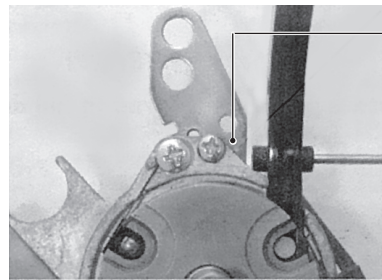

PRO 1000

NOTE
Pro 1000's built prior to 1992 do not have Attach Lug. Purchase a new carrier, or return yours to the factory with a check for \$10 plus S&H.

- Attach the action rod to feeder link. Use the end hole as shown. The action rod must be on the outside of the feeder link. Hook return spring legs into bullet feed body.
- Attach the Bullet Feeder assembly to the press using the Lee Bullet Feed and Seat Die. When installing the bullet feeder, be sure the action rod and damper is in correct hole for the press you are using. The initial setting of the die is three [3] turns from the shell plate. Adjust die inward for desired crimp.

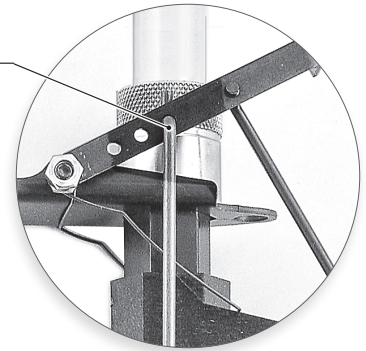

LOAD-MASTER

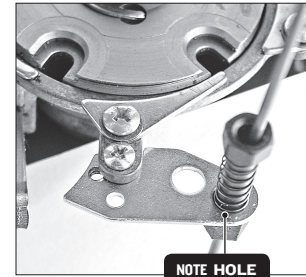

NOTE HOLE

PRO 1000

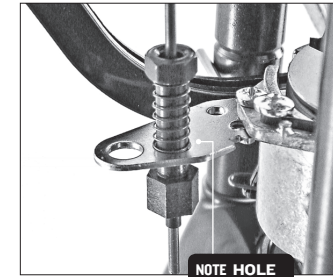

NOTE HOLE

TYPICAL LOAD-MASTER INSTALLATION

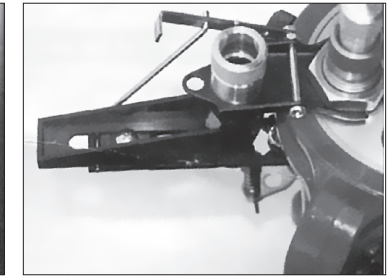

- Install correct feed tube. The small feed tube slips inside the large tube for installation.

INITIAL TESTING

1 Carefully cycle press making certain the fingers and mechanism clear everything. **Use extreme caution when cycling the .45 caliber empty. It is very easy to pinch the fingers between the die and shell plate if no bullet is in the feed finger.**

2 Pull back on the feed fingers to open them and drop the first bullet, base down into the feed tube. Now fill the rest of the feed tube with bullets. See photo at right.

Note: A full tube of large caliber bullets may be too heavy for the feed fingers to pull one out of the bottom of the stack. Bullets that have a concave base or that are fully coated with Alox or wax should not be stacked as high. You will have to experiment to find out how many can be stacked. Usually, 4000 grains of cast bullets and 5000 grains of jacketed bullets work fine.

3 Try it without cases, to get a feel of the tool and ensure that it is installed correctly and functioning correctly. Catch the bullets in your hand.

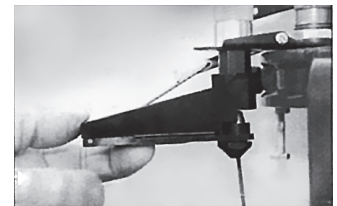

IMPORTANT INFORMATION

- ⊘ Do not store press with carrier in full down position or fingers will take a set in the open position.
- ⊘ Do not store press with bullet in the feed fingers or fingers will take a set in the open position.
- ⚠ If the feed fingers take a set in the open position, they can be quickly repaired by placing them in boiling water.