

SPO10L2SDL



Family	Ovens
Subfamily	Combi oven 10 GN1/1 - 8 600x400 trays
Power supply	Electric
Oven type	Convection with fan- Humidified - With EBT technology - Trivalent combisteamer
Trays capacity	10 trays GN1/1
Power supply	400 V 3N~ / 28A / 14,5 kW / 50-60Hz
Steam generation	Direct and Open boiler
Adjustable feet	Yes
Product dimensions WxDxH	790x840x1145 mm
Maximum depth with open door	1581 mm



Distribution

Industries	Hotels; Restaurants; Butcher shops / Delicatessens; Care facilities ; Commercial food services; Grocery shops / Food retail
-------------------	---

Aesthetics

Door with stainless steel stripes	Yes	Digit display color	Multicolor
Colour	Stainless steel/Black	Front panel Serie	Glass/Stainless steel Galileo PROFESSIONAL
Display type	Yes, 7 inches touch		

Controls

Recipes number	512	Hold function	Adjustable
Preset recipes	Yes	Forced cooling	Boiler 71°C/Tank 60°C-50"
Timer setting range	1 minute-12h, 12h-59minutes, endless	Chimney regulation	Scheduled start H/12
Cooking steps	8 + preriscaldamento + mantenimento	Wash programs	Yes
Delayed start	Yes; Same time	Haccp data	Yes
Pre-heating	Yes	Self diagnostic	Yes

Options

Solutions

K510X

Accessories Included

Probe 4 points external core probe **Manual shower** Yes

Electrical Connection

Plug No

Construction

Oven materials	Ever Clean enamel	Drain diameter	40mm
Cavity dimensions (lxdxh)	670x560x860 mm	Exhaust position	Back
Cavity material	Stainless steel	Components cooling system	Yes
Shelves number	10	Timer type	Electronic timer
Tray frame support	Stainless steel AISI 304	Temperature range	30-270°C
Adapter kit for trays 600x400 mm	Chromed wire double format	End cooking signal	Yes
Shelves distance	90 mm	Manual reset safety thermostat	Yes
Door construction	Yes	Removable deflector	Yes
Door opening	Lateral	Detergent type	Liquid
Handle type	New ergonomics	Lighting	2 LED lamps
Openable glass	Openable	Light power	2x14W
Fan type and number	2 ventole con inversione rotazione	USB port	Yes
Pulse fan	2 contrarotating fans with time direction reversal	Components cooling system	Yes
Engine speed	2x200W	Water entries number	1
Engine speed	Ever Clean enamel	Water load pipe	Yes
Max standard speed motor rpm	2	External detergent containers system	Yes
Low speed rpm	1425 rpm	Water inlet pressure	200-1000 kPa (min-max)
Water injection on each fan	Yes	Power cable length	170 cm
Humidification levels	None	Back panel	Galvanized
Steam control	5-100% (min-max)	IPX protection	IPX4
Open boiler	Yes		

Logistic Information

Packed product dimensions (WxDxH)	960x960x1300 mm	Net weight	140.000 kg
EAN code	8017709338879	Gross weight (kg)	160.000 kg

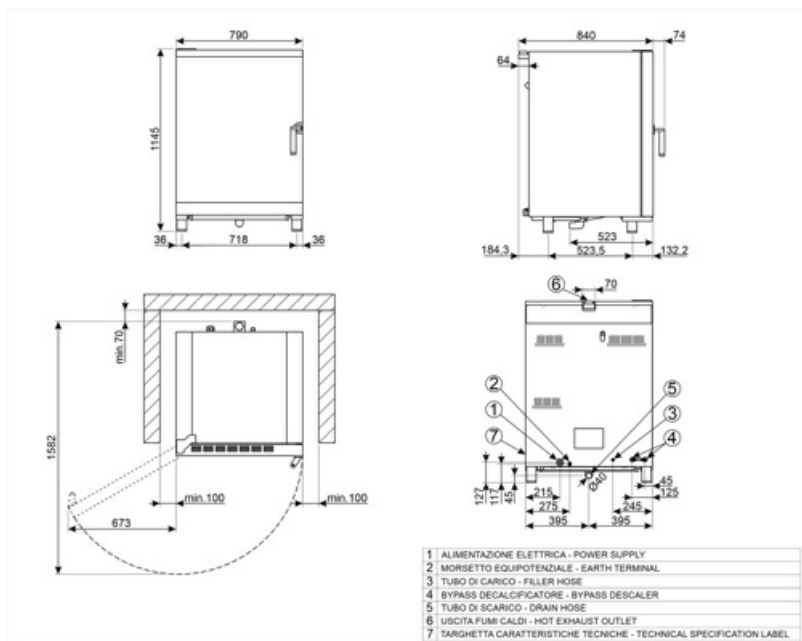

Compatible Accessories



CLB45LSE

Flow meter for filter FB45LSE1100



FB45LSE1100

Water treatment filter for PO45LSE; 7.900 litres capacity with 10 Kh° hardness and bypass set 1



FB45LSE500

Water treatment filter for Galileo professional oven; 4.675 litres capacity with 10 Kh hardness and bypass set 1

G11T

Non-stick GN1/1 tray for Galileo professional

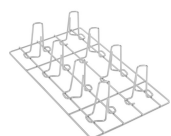
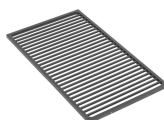

G11X8P

8 vertical GN1/1 chicken grid for Galileo professional



KCAM10

Chimney kit for Galileo professional 10 trays



R8EN6040

Support kit for 8 EN 600x400 trays for Galileo professional oven



RUTVL

Wheels kit for all oven table models (4pcs)



T11TH20

2cm height GN1/1 non-stick tray for Galileo professional



T11TH40

4cm height GN1/1 non-stick tray for Galileo professional



T11XH20

2cm height aluminium GN1/1 tray for Galileo professional



T11XH65

6,5cm height aluminium GN1/1 tray for Galileo professional



T8S11T

8 holes GN 1/1 non-sticking tray for Galileo professional



TB45LSE

Water treatment filter head connection kit

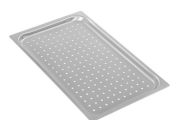

TF11XH2



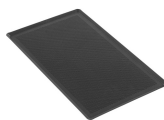







Perforated aluminium GN1/1 tray for Galileo professional



TMF11TH2

GN 1/1 non-sticking microperforated tray

Symbols glossary

	Electric		Humidity and heat controlled proofing
	Fan speed adjustable between 50 and 100% of the speed		Automatic washing
	Dry heat for a perfect grill		Core probe + Δt
	Fan forced heating		Steam and hot air combined cooking
	Steam generated by injecting water into the fan and evaporation on the heating element		Saturated steam created by boiling in the cavity
	Low cooking sous-vide		

Benefit (TT)

Hinged opening

Easily accessible glass for effortless maintenance and cleaning

The glass panels are designed to be easily accessible and inspectable, ensuring great convenience during cleaning and maintenance operations. This feature significantly simplifies the process, making it quick and efficient, while ensuring that every intervention can be carried out with maximum comfort and complete safety.

WashArt System

Efficient washing, optimised consumption, and minimal space usage

The WashArt washing system, equipped with a rotating nozzle, ensures even distribution of water and detergent within the cavity, providing deep cleaning and quick drying. To meet every need, four washing programmes are available: Short, Medium, Long, and Grill, along with a dedicated rinse programme. Thanks to its advanced technology, WashArt optimises efficiency and reduces consumption, while the rotating nozzle, with its compact design, minimises space usage in the cooking chamber.

Fan speed

Precise fan speed modulation for consistently even cooking results

In the Galileo Professional ovens, the fan speed can be adjusted from a minimum of 50% to a maximum of 100%, in 5% increments. This feature allows for precise customisation of the airflow, perfectly adapting it to the specific needs of each preparation. Thanks to this versatility, it is possible to achieve flawless cooking results, ensuring even and accurate heat distribution. Moreover, precisely adjusting the fan speed helps preserve the delicacy of sensitive foods, preventing exposure to excessive heat and creating the ideal conditions to maintain their lightness and internal structure.

Core probe

Multipoint cooking sensor for precise and uniform results

SteamArt Technology

Open Boiler system to generate steam directly within the cavity, in quick times and at very low temperatures

Thanks to the innovative Open Boiler system, steam is generated directly within the cavity, in very short times and at very low temperatures (starting from 30°C, ideal for supporting the proofing phase). This system is particularly suited for delicate cooking processes that require the use of 100% steam, ensuring even and gentle cooking that preserves the nutritional properties, taste, and texture of the food.

8 cooking stages

Flexibility and precision in every cooking stage

The ability to set multiple cooking phases, in addition to preheating and keeping warm, gives the combi-steam oven exceptional versatility, responding precisely to the diverse needs of every preparation. Each phase of the cooking process can be customised with great accuracy, optimising results whether it's slow cooking at low temperatures or achieving a perfect final browning. Thanks to the advanced control of steam and heat parameters, it is possible to achieve even cooking on every surface, significantly enhancing the quality of the finished product and ensuring flawless results.

Waste water cooling

The temperatures are significantly lowered and the thermal impact reduced thanks to the waste water cooling system

Some ovens are equipped with a waste water cooling system that significantly lowers the temperature of the water before it is released, minimising the thermal impact. This mechanism optimises energy efficiency, enhances operational safety, and supports eco-friendly practices, helping to make the oven more sustainable and high-performing.

System for external detergent tanks

Efficient cleaning operations and optimal resource management

Some oven models are designed to use an external detergent tank and are equipped with dedicated suction hoses. This solution provides greater autonomy, reducing the need for frequent refills, and significantly simplifies the detergent replenishment process. As a result, cleaning operations become more efficient and continuous, without interruptions, ensuring optimal resource management and high hygiene performance.