



K+ SERIES: KBT-SB4 Four Burner Boiling Top

Project: _____ Item: _____



KBT-SB4

Standard Features:

- Stainless Steel Frame
- Powerful 30Mj Cooktop Section Burner comes in two pieces for easy cleaning
- Multi-setting gas valve as standard allowing for greater regulation of flame setting
- Heavy Duty Cast Iron Trivets
- Open Stand with Under Shelf
- Easy to clean fat spillage tray
- Front access to all components makes service easy
- Flame Failure device standard
- 18-Month Warranty

Options:

- Natural or LP Gas
- Castors

Specifications:

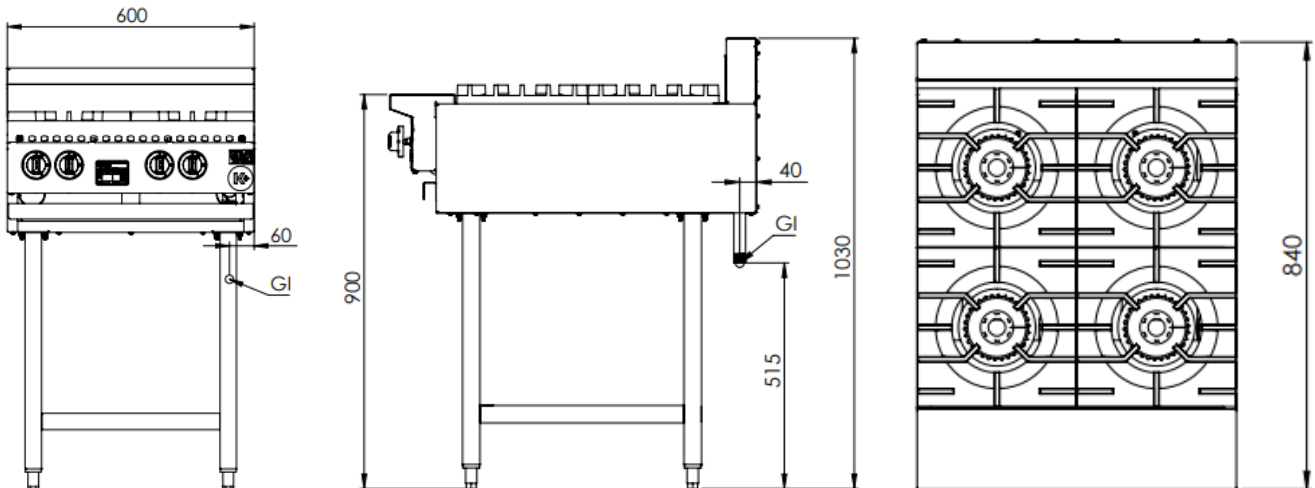

| MODEL | LENGTH (mm) | DEPTH (mm) | HEIGHT (mm) | GAS CONSUMPTION (Mj/h) | |
|---------|-------------|------------|-------------|------------------------|-----|
| | | | | NG | LPG |
| KBT-SB4 | 600 | 840 | 1030 | 120 | 120 |

Connections:

| GAS (GI) (BSP) | SUPPLY PRESSURE (kPa) | |
|----------------|-----------------------|-----|
| | NG | LPG |
| ¾" (M) | 1.0 | 2.6 |

- Regulator is included in the unit
- **Must** be installed by an authorised installer

Due to ongoing Product Development, Product Improvement and Research, B+S Commercial Kitchens reserves the right to alter specification without notice.



B+S Commercial Kitchens
57 Plateau Road Reservoir VIC 3073 Australia | +61 3 9469 4754
info@bscommercialkitchens.com | www.bscommercialkitchens.com

