

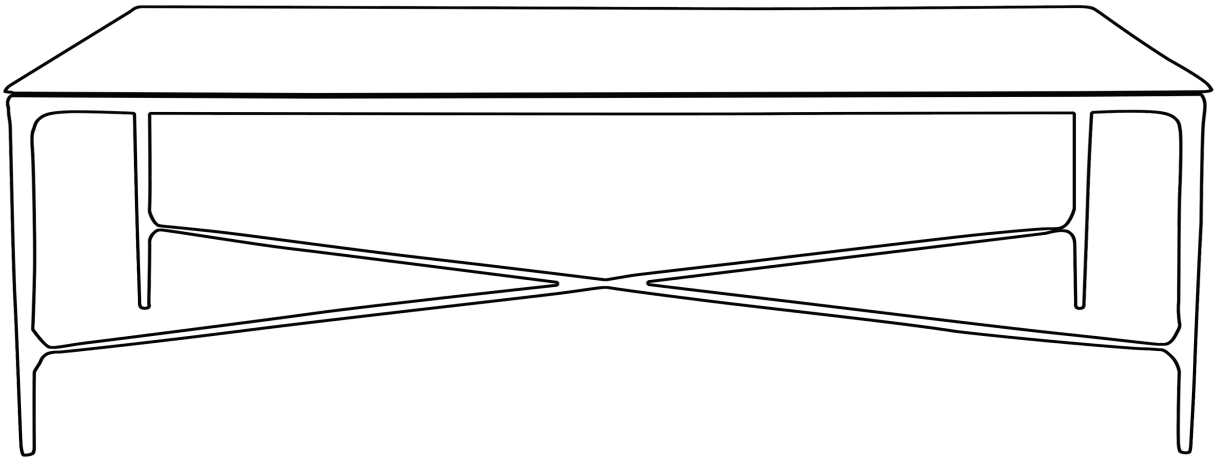





Assembly Instructions

HESTON RECTANGLE MARBLE COFFEE TABLE

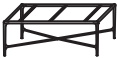

Component Checklist

REF	PART	NAME	QTY
A		Table top	1
B		Table frame	1
C		16mm screw	6
D		Round washer	6
E		Allen Key	1

Putting Me Together

NOTE: You will need a minimum of 2 persons to assemble due to size and weight of marble table top.



1

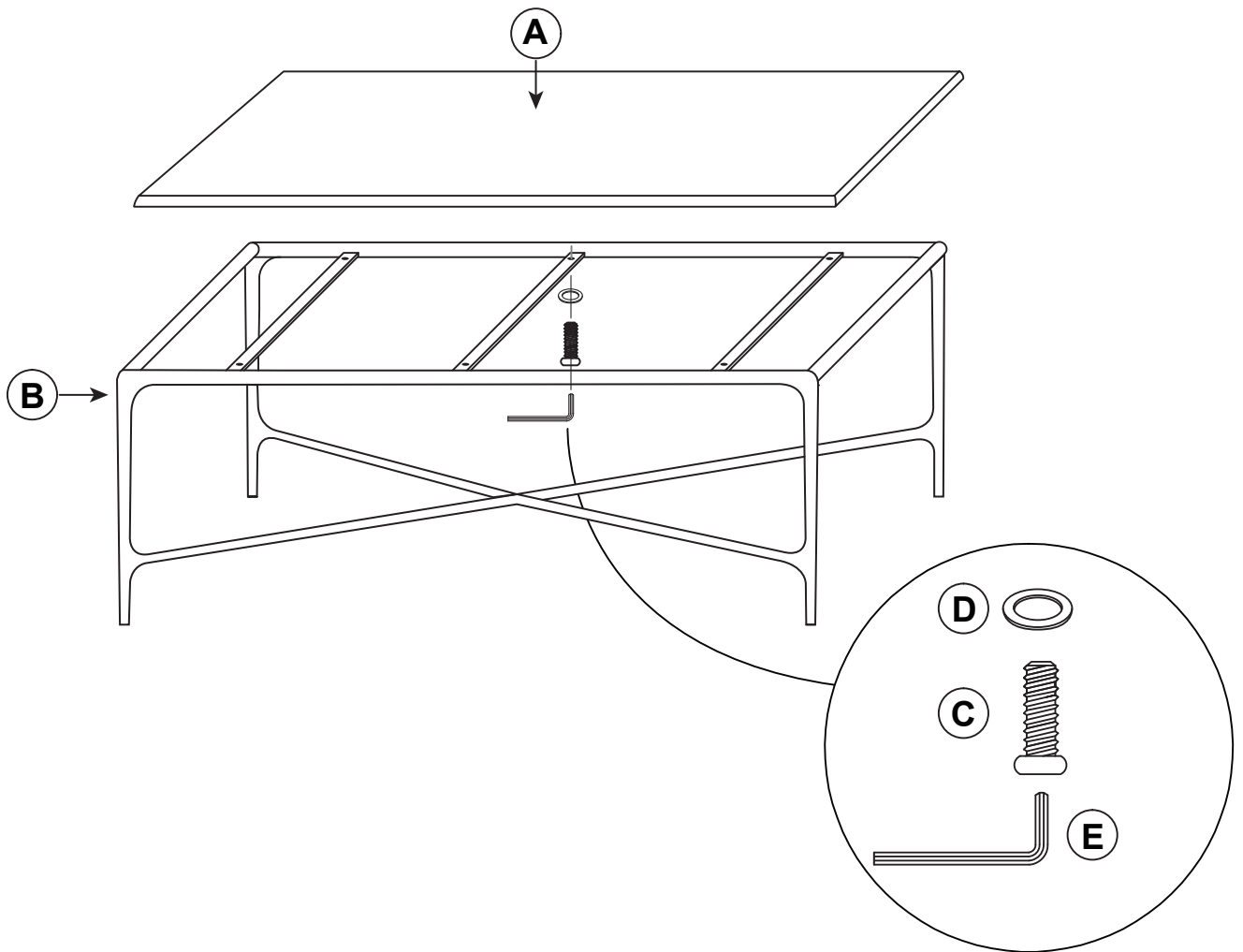

- Carefully place table top (A) on to iron table base (B) making sure to align the screw holes
- Once aligned, place washer (D) over hole and proceed to screw in (C) using provided allen key (E)

TIP: Do not fully tighten until all screws are in place