

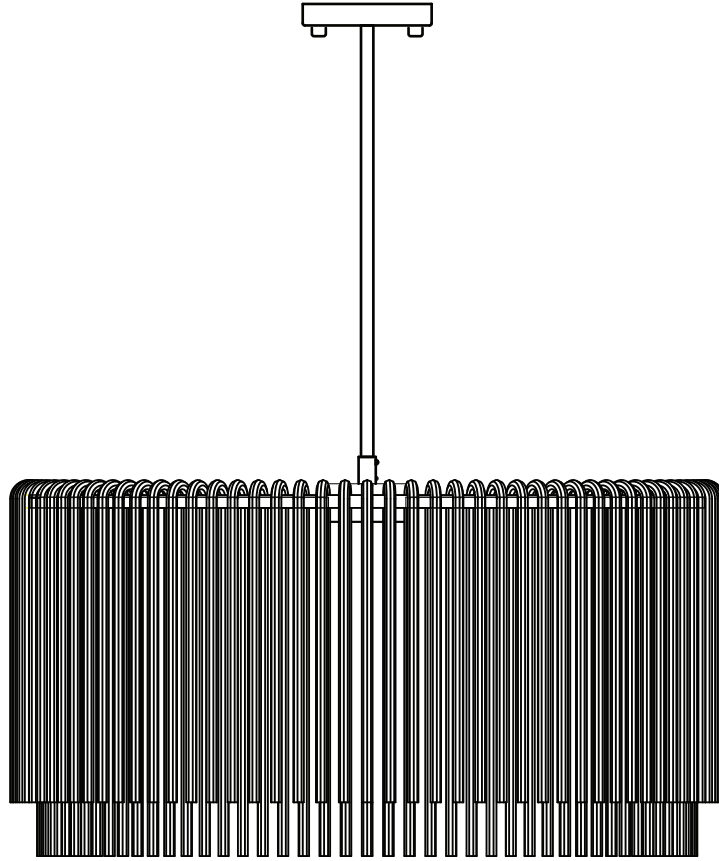







Assembly Instructions

ZARA PENDANT

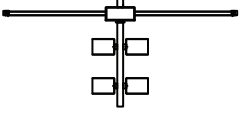

Component Checklist

REF	A	B	C	D	E	F	G
PART							
NAME	Ceiling Plug	Ceiling Screw	Ceiling Bracket	Ceiling Rod	Extension Rod	Pendant Base	Glass Rod
QTY	4	4	1	1	1	1	96

Putting Me Together

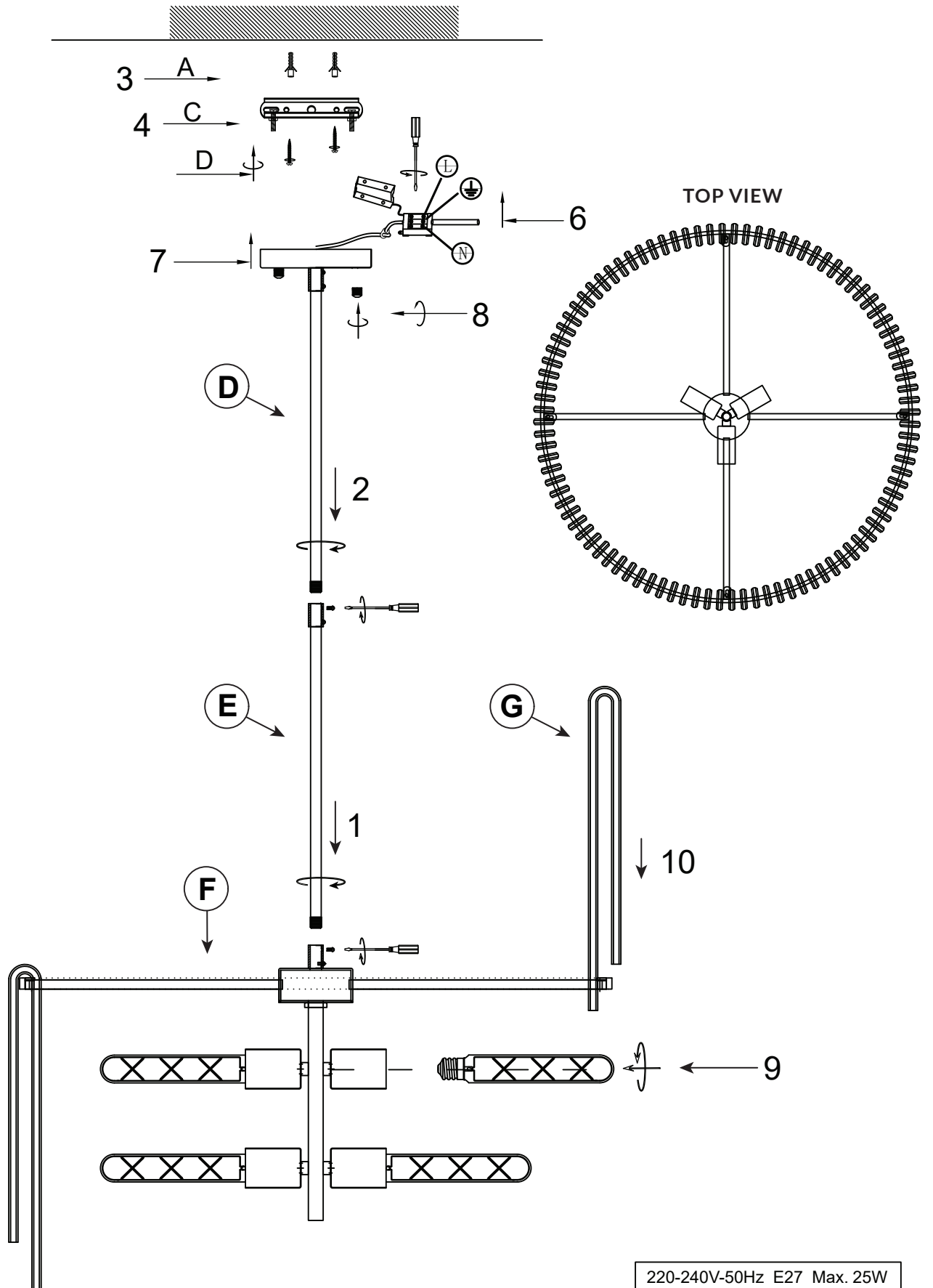



NOTE: THIS ITEM MUST BE INSTALLED BY A LICENSED ELECTRICIAN

WARNING: Switch off the main electrical supply at the main fuse box / circuit breaker before installation.

- ① Carefully remove all the parts from the box.
Screw extension rod (E) into the top section of pendant frame (F) being careful to gently pull excess electrical cord through the top of rod. Support connection through tightening grub screws.
- ② Screw ceiling rod (D) into the top section of extension rod (E) now attached to pendant frame (F) being careful to gently pull excess electrical cord through the top of ceiling cap.
- ③ **Due to its weight, this pendant must be installed to a support beam in the ceiling.**
 - Take the mounting bracket (C) from the ceiling cap by taking off the screws.
 - Drill holes into the ceiling support beam according to the size of mounting bracket screws in line with holes in mounting bracket (C)
 - Insert ceiling plug (A) into the holes in ceiling support beam
- ④ Fix mounting bracket (C) to the ceiling support beam using screws (B).
- ⑤ **ENSURE THE ELECTRICITY SUPPLY IS TURNED OFF.**
- ⑥ Connect the 3 power wires from the pendant to the power wires in the ceiling.
 - Brown is the Live wire
 - Blue is the Neutral wire
 - Green/Yellow is the Earth wire
- ⑦ Attached the assembled pendant ceiling cap to the mounting bracket (C).
- ⑧ Secure pendant to ceiling by screwing ceiling cap knobs onto downward facing mounting bracket screws.
- ⑨ Insert E27 globes into each lamp holder screwing in until they are firm (globes not included).
- ⑩ Unwrap individual glass rods (G) and carefully hang over grooved circular pendant frame with shorter length of glass rod facing outwards.
- ⑪ Once glass rod placement is complete, turn the electricity supply back on and enjoy!