

550ml / 16oz Kraft BioBowl BSCK-16-GS

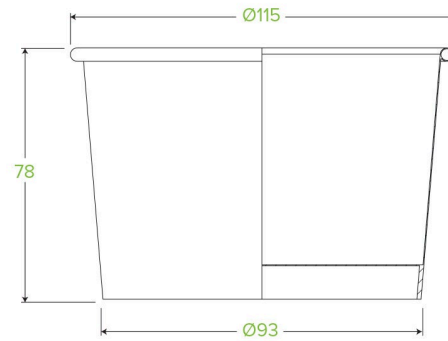

16oz kraft paper bowls are lined with a plant-based bioplastic, not fossil-fuel plastic. Certified industrially compostable. Suitable for hot/cold food and soup-safe. This compostable bowl is printed kraft-look.

Carton quantity: 500	Sleeves per carton: 20	Units per sleeve: 25
Carton Size LxWxH (cm): 58x46.5x31	Carton gross weight (kg): 8.230000	Carton barcode: 19344062023408
Raw material: Paper - FSC™ Mix certified paper	Lining/coating: Bioplastic - PLA	Window material: None
Printing Type: Offset	Inks: Food Contact Safe Inks	Brim fill capacity (ml): 560
Dimensions top LxW (mm): 115	Dimensions base LxW (mm): 93	Product Depth: 80
Product weight (g): 13.72	Thickness: 320gsm	Use: Hot, Cold, Wet & Dry Products
Manufactured: China	Customise: None	MOQ custom: 25000
Mould fees: No	Environmental production certified: ISO 14001	Facility Quality Systems: ISO 9001
Factory food safety certified: BRC	Corporate social accreditation: SMETA	Home compostable: No
Industrially compostable: Certified to AS4736 Australian Standards, Certified to EN13432 European Standards	Recyclable: No	