



Dimensions in: mm/inch



Series 34

**LED navigation lights –
The latest LED generation in
an attractive and slim design.
Totally maintenance-free**

Application

Application depending on required visibilities. See product table

Housing

Polycarbonate, seawater resistant, UV protected, non-corrosive, non-magnetic, impact and shock resistant

Optics

Innovative lens technology for wide visibility requires only one light-emitting diode

Mounting

Mast-mount

Electric

Invers polarity protection included, bulb included

1 All-round white, red, green

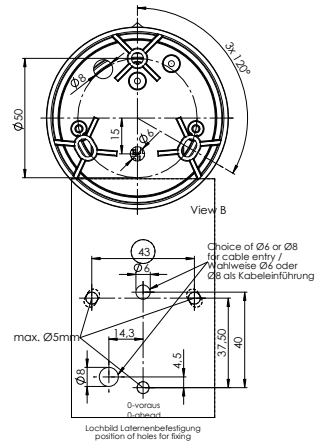
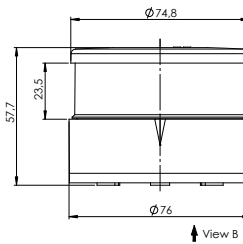

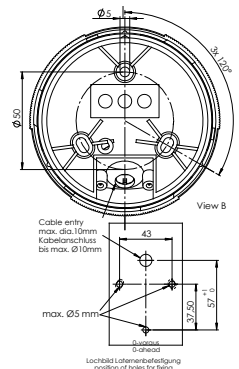
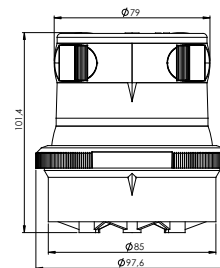

2 Masthead & Tricolor

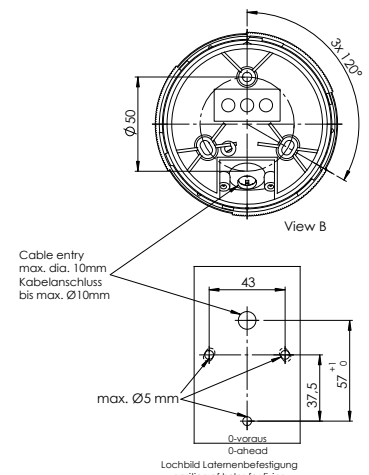
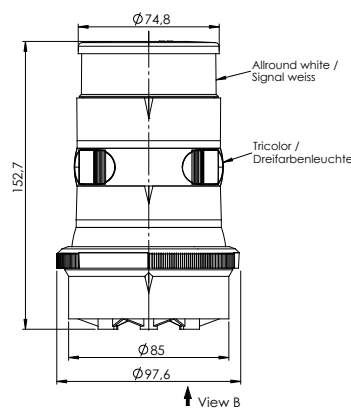

3 Masthead / Anchor & Tricolor / Anchor





No.		Description	Ship size	Wattage	Visibility	Housing color	Mounting	Voltage	Article number
1		All-round white	< 50 m/ < 164 ft.	1,0 W	2 nm	Black	mast-mount	12V, 24V	3854001000
		All-round white	< 50 m/ < 164 ft.	1,0 W	2 nm	White	mast-mount	12V, 24V	3854101000
		All-round red	< 50 m/ < 164 ft.	app. 1,3 W	2 nm	Black	mast-mount	12V, 24V	3854161000
		All-round red	< 50 m/ < 164 ft.	app. 1,3 W	2 nm	White	mast-mount	12V, 24V	3854181000
		All-round green	< 50 m/ < 164 ft.	1,0 W	2 nm	Black	mast-mount	12V, 24V	3854121000
		All-round green	< 50 m/ < 164 ft.	1,0 W	2 nm	White	mast-mount	12V, 24V	3854141000
2		Masthead	< 20 m/ < 65 ft.	2,1 W	3 nm	Black	mast-mount	12V, 24V	3855001000
		Masthead	< 20 m/ < 65 ft.	2,1 W	3 nm	White	mast-mount	12V, 24V	3855101000
		Tricolor	< 20 m/ < 65 ft.	1,9 W	2 nm	Black	mast-mount	12V, 24V	3856001000
		Tricolor	< 20 m/ < 65 ft.	1,9 W	2 nm	White	mast-mount	12V, 24V	3856101000
3		Masthead / Anchor	< 20 m/ < 65 ft.	2,1 W (Masthead) 1,0 W (Anchor)	3 nm, 2 nm	Black	mast-mount	12V, 24V	3858001000
		Masthead / Anchor	< 20 m/ < 65 ft.	2,1 W (Masthead) 1,0 W (Anchor)	3 nm, 2 nm	White	mast-mount	12V, 24V	3858101000
		Tricolor / Anchor	< 20 m/ < 65 ft.	1,9 W (Tricolor) 1,0 W (Anchor)	2 nm	Black	mast-mount	12V, 24V	3857001000
		Tricolor / Anchor	< 20 m/ < 65 ft.	1,9 W (Tricolor) 1,0 W (Anchor)	2 nm	White	mast-mount	12V, 24V	3857101000