

DYNAMIC TRIM CONTROL SYSTEM

ZIPWAKE **PRO**

OPERATOR'S MANUAL

ZIPWAKE

CHOOSE COMFORT. ENJOY PERFORMANCE.

Disclaimer

Zipwake disclaims any responsibility for loss of time, lifts, towing or transportation costs or any other indirect, incidental or consequential damage, injury, inconvenience or commercial loss when using this product. Zipwake will not assume liability in case of damage arising from improper use, improper installation or modification of our products or accidents involving them, or lost-profit claims by a third party.

Trademark notice

Zipwake is a registered trademark of Prezip Technology AB, Sweden. All other trademarks, trade names, or company names referred to herein are used for identification only and are the property of their respective owners.

Patent notice

This product is protected by patents, design patents, patents pending, or design patents pending.

Declaration of conformity

This product conforms to the following Electromagnetic Compatibility (EMC) regulations and standards for use in marine environments.

CE EN 60945
FCC CFR 47, Part 15, Subpart B
DNV Std No. 2.4
IACS E10
GL GL VI 7.2

Correct installation according to Zipwake documentation is required to ensure that EMC performance is not compromised.

The product follows ABYC recommended practices, E-11: AC and DC Electrical Systems on Boats and H-27: Seacocks, thru-hull fittings and drain plugs.

Zipwake Pro is NMEA 2000® certified (software release 4.0 or higher). NMEA Network Message database version 3.000.

Documentation and technical accuracy

To the best of our knowledge, the information in this document was correct at the time it was produced. However, Zipwake cannot accept liability for any inaccuracies or omissions it may contain. In addition, our policy of continuous product improvement may change specifications without notice. As a result, Zipwake cannot accept liability for any differences between the product and this document.

Fair use statement

You may print a copy of this manual for your own use. You may not give or sell copies to third parties and not in any way exploit the manual commercially.

Product disposal



Dispose of this product in accordance with the WEEE Directive.

 The Waste Electrical and Electronic Equipment (WEEE)

The WEEE Directive does not apply to some Zipwake parts; however we support its policy and ask you to be aware of how to dispose of this product.

Product Registration

Register your product online at zipwake.com/register to allow notifications of news and available software updates etc.

DISCLAIMER

ALL PRODUCT SPECIFICATIONS AND DATA ARE SUBJECT TO CHANGE WITHOUT NOTICE TO IMPROVE RELIABILITY, FUNCTION OR DESIGN OR OTHERWISE.

Zipwake, its affiliates, agents, and employees, and all persons acting on its or their behalf (collectively, "Zipwake"), disclaim any and all liability for any errors, inaccuracies or incompleteness contained in any datasheet or in any other disclosure relating to any product.

TABLE OF CONTENTS

1	IMPORTANT INFORMATION	4
1.1	READING THE OPERATOR'S MANUAL	
1.2	GENERAL SAFETY INSTRUCTIONS	
1.3	SPECIAL OPERATING NOTES	
2	SYSTEM OVERVIEW	5
2.1	KEY FEATURES	
2.2	MOTION CONTROL FEATURES	
3	INSTALLATION	7
3.1	GPS	
3.2	IGNITION SWITCH INSTALLATION	
4	CONTROL PANEL OVERVIEW	8
4.1	BASIC PANEL FUNCTIONS	
4.2	MENU NAVIGATION AND SOFTKEY FUNCTIONS	
4.3	MAIN DISPLAY OVERVIEW	
4.4	SPEED-PROGRESSIVE CONTROL WHEELS	
5	INITIAL START	10
5.1	SETTING UP THE SYSTEM	
5.2	CHECK GPS SIGNAL	
5.3	RESET THE PITCH AND ROLL ANGLES	
6	MANUAL MODE	15
6.1	MANUAL PITCH AND ROLL	
6.2	STEERING MODE	
6.3	WAKE MODE	
7	AUTO MODE	17
7.1	ACTIVATE AUTO MODE	
7.2	PRO ACTIVE PITCH CONTROL	
7.3	PRO ACTIVE ROLL CONTROL	
8	AUTO PITCH MODE	21
8.1	ACTIVATE AUTO PITCH MODE	
9	INTERCEPTOR SETUP	22
9.1	MANUAL CONTROL RATE	
9.2	AUTO CLEANING	
9.3	INTERCEPTOR INSTALLATION	
9.4	INTERCEPTOR CHECK	
10	TURN ON THE SYSTEM	26
11	TURN OFF THE SYSTEM	26
11.1	TURN OFF - SINGLE CONTROL PANEL	
11.2	TURN OFF - MULTIPLE CONTROL PANELS	
11.3	IGNITION SWITCH INSTALLATION	
12	DISPLAY SETTINGS	27
13	ADVANCED SETUP	28
13.1	FACTORY RESET	
13.2	IMPORT/EXPORT DATA	
14	SYSTEM INTEGRATION	29
14.1	ZIPWAKE INTEGRATOR MODULE	
14.2	NMEA 2000	
15	TROUBLESHOOTING	30
15.1	SYSTEM ERROR INFORMATION	
15.2	BATTERY WARNING	
15.3	ERROR CORRECTIVE ACTIONS	
15.4	OTHER ERRORS	
16	MAINTENANCE	32
16.1	LAUNCH	
16.2	HAUL-OUT	
17	SYSTEM UPGRADE	33

1 IMPORTANT INFORMATION

1.1 READING THE OPERATOR'S MANUAL

Make sure that you read and understand this Operator's Manual before using the Dynamic Trim Control System. If you have trouble understanding any part of the manual, please contact your retailer for further information.

⚠ IMPORTANT Information presented as IMPORTANT may lead to system or property failure or damage if it is disregarded.

⚠ WARNING Information presented as a WARNING may lead to personal injury if it is disregarded.

NOTE!

Information presented as a NOTE! is important information about the Trim Control System's operation and features.

1.2 GENERAL SAFETY INSTRUCTIONS

The Trim Control System is an accessory that delivers a more comfortable boat ride, better performance and improved fuel consumption. Keep in mind that it under no circumstances takes away the responsibility from the helmsman to maneuver the boat in a safe way.

Take your time to get familiar with the system and its functions in calm waters and get used to how it will affect your boat's handling before using it under normal conditions.

⚠ WARNING The Trim Control System may affect your boat's capacity to stay on course. Always pay close attention to steering the boat.

⚠ WARNING Never try to force the interceptor blades by hand. Watch out for sharp edges when close to the interceptors. Turn off the system when the boat is docked, at anchor or hauled out of the water.

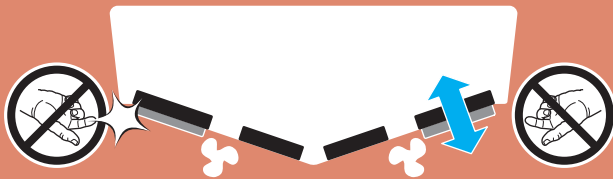

1.3 SPECIAL OPERATING NOTES

⚠ IMPORTANT The Dynamic Trim Control System should be the main system controlling your boat's running trim. If the boat has an outboard engine or a sterndrive, their respective trim (propeller shaft inclination) should be set to zero, except possibly at high speeds, or if automatic control is added when necessary in addition to the basic trim provided by the interceptors.

2 SYSTEM OVERVIEW

The next-generation Zipwake Dynamic Trim Control System Pro builds on the strengths of the original range, delivering five times faster control for boats up to 30 meters (100 feet). This advanced system features durable, fast-acting interceptors and Zipwake's intuitive 3D control interface, as well as integrating seamlessly with multifunction displays. Offering automatic and precise trim, heel, and heading adjustments, it gives the helmsman unmatched control while significantly improving performance, fuel efficiency, comfort, and safety.

2.1 KEY FEATURES

AUTO PITCH CONTROL

The system will automatically adjust the trim or pitch angle of your boat, minimizing wave resistance for best performance and comfort at all speeds (chapter 7).

AUTO ROLL CONTROL

The system will automatically eliminate uncomfortable and dangerous boat roll. The system constantly works to keep the boat level or to make balanced (banked) turns (chapter 7).

MANUAL ATTITUDE CONTROL

The boat's running attitude (chapter 6.1) can be manually controlled by using the control wheels. The Pitch wheel controls the trim or pitch angle, while the Roll wheel normally controls the list or roll angle. In Steering mode (chapter 6.2), the Roll wheel controls the boat's heading or yaw angle.

EXTERNAL MONITORING AND SYSTEM CONTROL

The system can be fully controlled from external devices, e.g. multifunction displays (MFD) via Zipwake's integrator module (chapter 14.1). Data from any Zipwake system can also be monitored on NMEA 2000® devices, e.g. chart plotters (chapter 14.2).

SYSTEM OVERVIEW

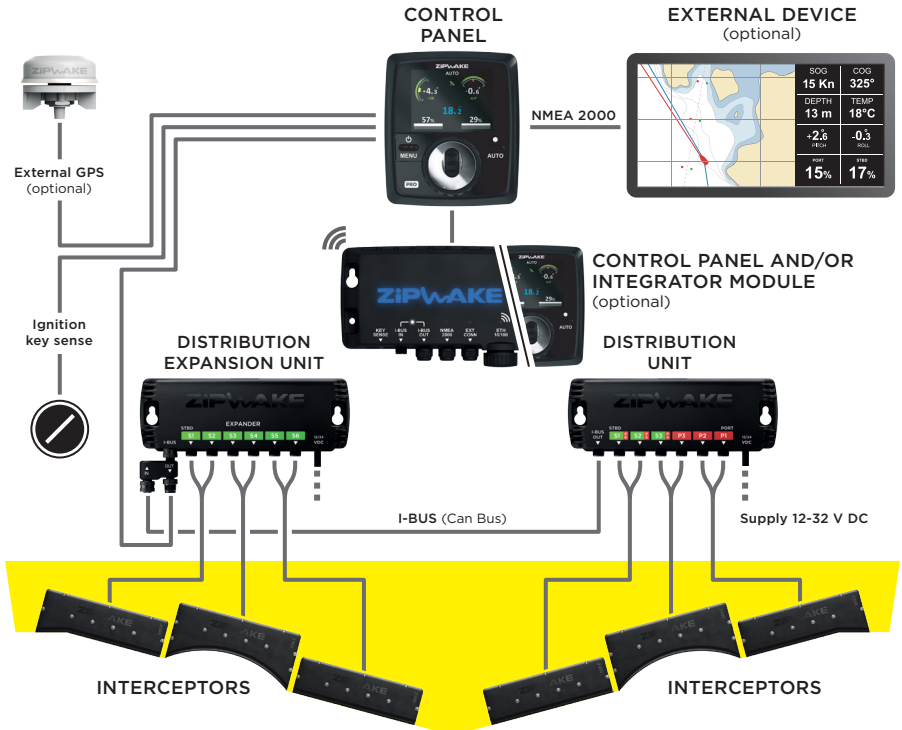

2.2 MOTION CONTROL FEATURES

PRO ACTIVE PITCH

Pro active pitch control refers to rapid automated adjustment of the vessel's pitch angle to optimize performance, fuel efficiency, stability, and comfort. Using the system's sensors, the active pitch controller continuously modifies the interceptors' extensions to dampen pitch motions and hold the boat at its optimum running trim angle.

PITCH OFFSET

The pitch offset function allows adjustment of the vessel's target pitch angle or interceptor extension (relative to predetermined settings). This enables the operator to easily fine-tune performance under varying sea states and load conditions. The system also include means for easy permanent adjustment of predetermined settings.

PRO ACTIVE ROLL

Pro active roll control refers to rapid automated adjustment of the vessel's roll angle to optimize performance, stability, and comfort. Using the system's sensors, the active roll controller continuously modifies the interceptors' extensions to dampen roll motions and keep the boat level.

PRO BALANCED TURNS

The pro balanced turn function is designed to optimize comfort on board by maintaining the ideal heeling angle throughout turns, thereby eliminating the centrifugal forces experienced by the passengers. The function includes advanced turning recognition using the system's built-in sensors, avoiding awkward integration with the steering system.

ROLL ANGLE OFFSET

The roll controller's target angle can be offset to suit specific sea conditions. Running with a slight list of a few degrees can result in a drier ride.

ROLL SENSITIVITY CONTROL

The system allows adjustment of roll control responsiveness, which can be useful for optimizing system performance in different sea conditions or for use in combination with the auto-pilot.

OPTIONAL AUXILIARY TRIM/LIST CONTROL BY CLASSIC SWITCHES

The integrator module supports manual control of trim and list using rocker switches.

WAKE SHAPING

Interceptors are an ideal way to fine-tune the shape of the wake when wake surfing. The system's wake-shaping feature allows easy control of the interceptor blades, positioning them precisely to create the ideal wake shape on either side of the wave behind the boat.

3 INSTALLATION

Follow the steps in the Zipwake Installation Guide Pro (Series S or E) for mounting and connecting interceptors, the distribution unit(s), integrator module, control panel(s) and extra GPS on your boat.

3.1 GPS

⚠ IMPORTANT The system's automatic control functions remain off/turn off when no GPS speed signal is available.

Each control panel has a built-in GPS antenna, but additional GPS signals can be acquired via a Zipwake External GPS Antenna or NMEA 2000 (chapter 14). The system will automatically use the source with the best reception.



3.2 IGNITION SWITCH INSTALLATION

Connect the boat's ignition switch to the Key Sense input on the back of the control panel so that the system is automatically turned on/off when the ignition (engine) is turned on/off. Refer to the Installation Guide wiring diagram.

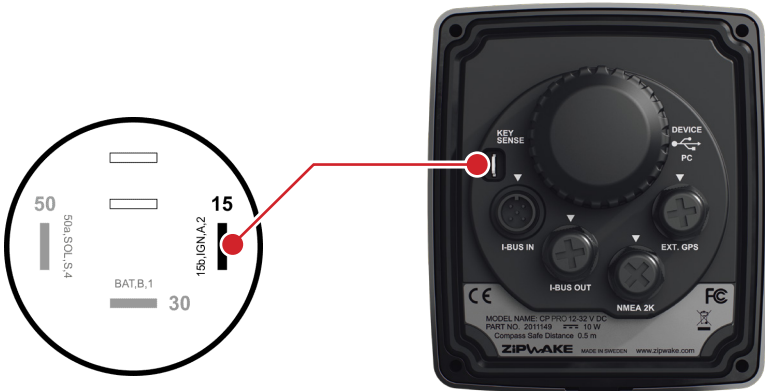

NOTE!

If an extra control panel is installed (multiple helm stations, e.g. a flybridge), connect the boat's ignition switch to the Key Sense input in the same way as on the main control panel.

4 CONTROL PANEL OVERVIEW

4.1 BASIC PANEL FUNCTIONS



- 1 Display**
Sunlight readable 2.8" IPS, 320x240 pixels, color display.
- 2 Light sensor**
The light sensor automatically adjusts the display brightness and shifts between Day and Night mode when the display mode is set to Auto.
- 3 POWER/MENU button**
Press and hold for power on/off.
- 4 AUTO button**
Press and hold for Auto mode on/off, then press for Auto Roll Control off/on.
- 5 Roll wheel**
Turn for manual roll control in Manual mode. Quick-press to open Auto Roll level screen in Auto mode, turn to adjust. Turn to steer the boat in Steering mode. Press-and-turn to switch between preset interceptor extensions in Wake mode. Press down for special functions: e.g. save current pitch offset and activate Steering mode.
- 6 Pitch wheel**
Turn for pitch offset (bow up/down) in Auto mode. Turn for manual pitch control in Manual mode.

4.2 MENU NAVIGATION AND SOFTKEY FUNCTIONS

- 3 POWER/MENU button**
Press to enter the menu.
Softkey for BACK, CANCEL.
- 4 AUTO button**
Softkey for OK, NEXT, SELECT, RESET, EDIT, SAVE, START, DONE and all choices in pop-up windows.
- 5 Roll wheel**
Turn to scroll between menu selections. Turn to adjust menu values. Turn to the desired speed when editing the Auto Pitch Curve. Press to select (same as AUTO button SELECT). Long-press to save interceptor configuration.
- 6 Pitch wheel**
Turn to scroll between menu rows. Turn to adjust menu values. Turn to adjust the interceptor extension at a desired speed when editing the Auto Pitch Curve.

4.3 MAIN DISPLAY OVERVIEW

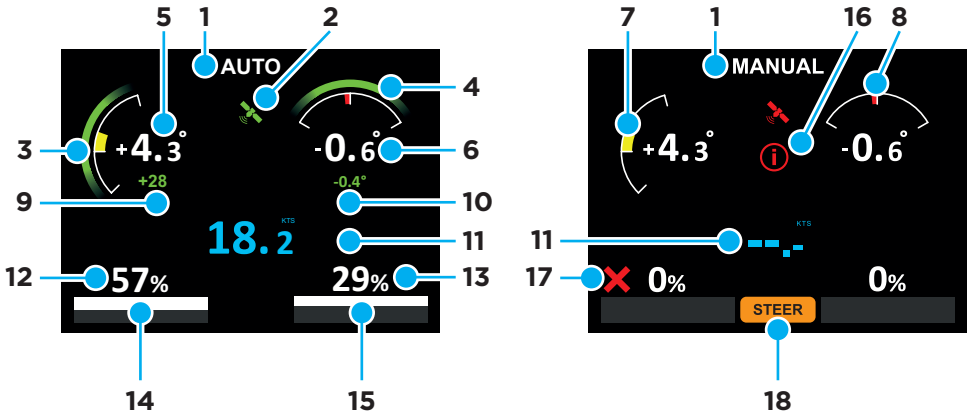

- 1 **Mode:** Indicates current mode - AUTO, AUTO PITCH or MANUAL
- 2 **GPS status:** Green - GPS fix OK Yellow - No GPS fix Red - No GPS connection
- 3 **Green arc:** Indicate that Auto Pitch Control is activated.
No green arc: Indicates manual pitch control - Auto Pitch Control turned off.
- 4 **Green arc:** Indicate that Auto Roll Control is activated.
No green arc: Indicates manual roll control - Auto Roll Control turned off.
- 5 **Pitch Angle:** Pitch angle indicator in degrees.
- 6 **Roll Angle:** Roll angle indicator in degrees.
- 7 **Pitch Indicator:** Visualizes the current pitch angle of the boat.
- 8 **Roll Indicator:** Visualizes the current roll angle of the boat.
- 9 **Pitch Offset:** Indicates manual pitch offset in Auto mode.
- 10 **Roll Offset:** Indicates manual roll offset in Auto mode.
- 11 **Boat Speed:** Current speed over ground. No GPS signal - No speed numbers.
- 12 **Port Interceptor Position:** Indicates port Interceptor(s) extension in percent.
- 13 **Starboard Interceptor Position:** Indicates starboard Interceptor(s) extension in percent.
- 14 **Port Interceptor Feedback:** Visualizes the current port Interceptor extension.
- 15 **Starboard Interceptor Feedback:** Visualizes the current starboard Interceptor extension.
- 16 **Error Information:** Indicates a system error - check the System Information menu.
- 17 **Interceptor Error:** Indicates an Interceptor error - check the System Information menu.
- 18 **STEER:** Indicates that Steering mode is activated.
WAKE: Indicates that Wake mode is activated.

4.4 SPEED-PROGRESSIVE CONTROL WHEELS

The Pitch and Roll wheels are speed progressive. A single “tick” on the Pitch or Roll wheel will move the interceptor blades one percent (1%). Turning a wheel faster equals more increments per “tick”. The number of increments when turning a wheel faster depends on the current speed of the boat. Low boat speed equals more increments and higher boat speed fewer increments, making manual pitch and roll control effective and safe.

5 INITIAL START

5.1 SETTING UP THE SYSTEM

NOTE! All selections made during Initial Start can be edited later from the System Menu.

1. Press and hold the POWER button until the Zipwake logo appears on the display.
2. Read the ATTENTION text and press OK or wait (7 sec) for the next step.



3. Select Language and press SELECT.



4. Select Units and press NEXT.
Metric: Kilograms, meters
Imperial: Pounds, feet

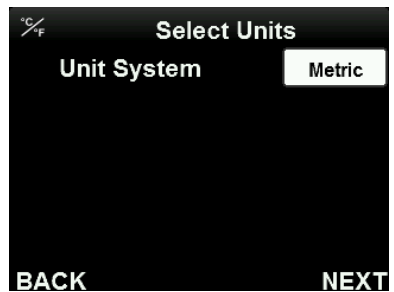

5. Enter Boat Length and press NEXT.
6. Enter Boat Beam and press NEXT.
7. Enter Boat Weight and press NEXT.

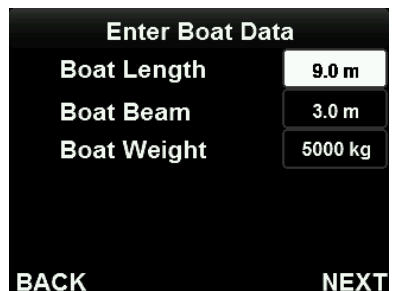

NOTE!

The system's automatic control functions need correct boat data to work properly. Hull length, max chine beam, and half load displacement are good choices.

8. Enter Hull Type (Mono or Catamaran) and press NEXT.

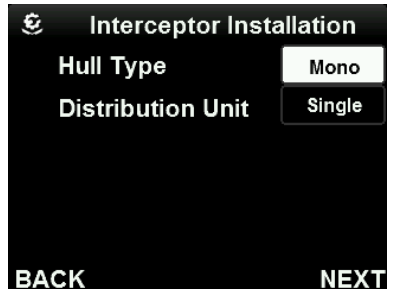

9. Enter Distribution Unit configuration.

10. Select the distribution unit installation that represent the actual installation.

11. Select SINGLE if the system installation only includes one Distribution Unit Pro (DU PRO).
 Select DOUBLE if the system installation also includes a Distribution Expansion Unit PRO (DU-EX PRO).
 Press NEXT.

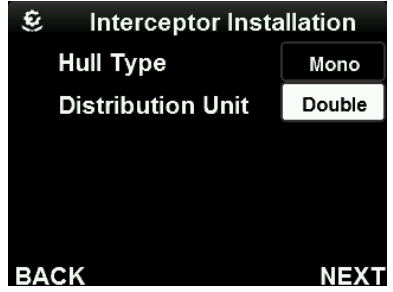

12. Verify that Interceptor Config. represents the actual installation and press NEXT. The interceptors will turn white when a valid configuration is saved to the system.

Single Distribution Unit

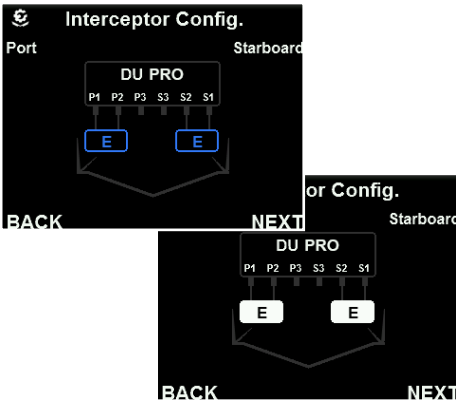

Double Distribution Units

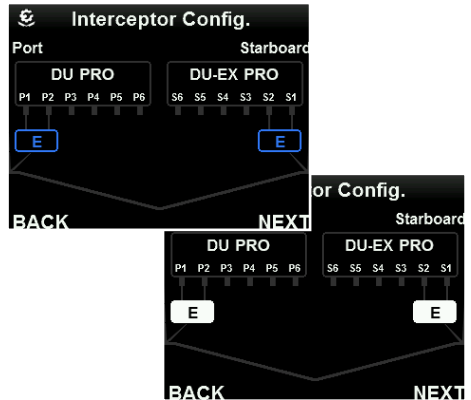

NOTE!

Refer to Interceptor Configuration (chapter 9.3.3) for more information.

13. Press NEXT to run the Interceptor Check.

or

Press SKIP to continue without performing the Interceptor Check (not recommended).

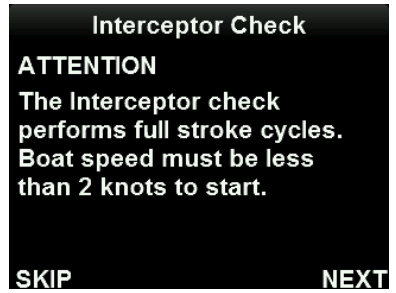

14. Turn the Roll or Pitch wheel to toggle different positioned interceptors, i.e. from Port interceptor 1 to Starboard interceptor 1. Press NEXT when the Interceptor Check is completed.

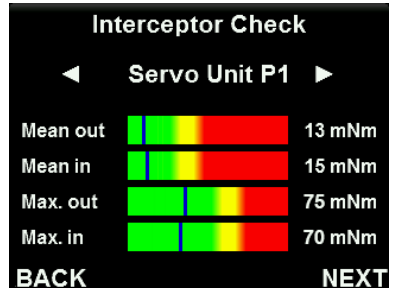

NOTE!

Interceptor Check will not start if no interceptor configuration has been saved to the system (chapter 9.3.3).

The check repeats a 5 stroke sequence, where each interceptor blade is extended and retracted. Visually confirm that the interceptors move during the check to confirm that the interceptors are correctly connected to the distribution unit(s).

For easy servo torque level assessment, the numerical values are depicted in green-to-red bar graphs, where green is acceptable and red is too high.

Refer to Interceptor Check (chapter 9.4) for more information.

⚠ IMPORTANT All readings must be green!

Corrective actions are always necessary when excessive torque levels are observed. Verify the flatness of the transom, excess use of sealant behind the interceptor and/or excess antifouling between the blades and adjust if needed. Check for blade damage and marine growth at regular intervals.

Always use the controls to move the interceptor blades.
Never try to force the interceptor blades by hand.

15. The system now resets pitch and roll angles and calculates the Auto Pitch Curve, which tells the system how much the interceptors will be extended at each speed when Auto Pitch Control (chapter 7) is activated. Press OK or wait until the pop-up window closes.

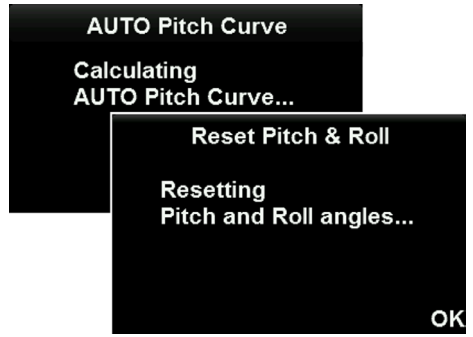

NOTE!

You can always start from the beginning by performing a Factory Reset (chapter 13.1).

5.2 CHECK GPS SIGNAL

⚠ IMPORTANT When starting the system for the first time, it may take several minutes for the GPS to acquire satellite reception.

1. Press the MENU button.
2. Select GPS Source and press SELECT.



3. GPS Source is set to Auto by default. The system will automatically select the GPS with the best reception. The menu header shows which source is currently selected
4. GPS Status 'Good' or 'Excellent' is required for the system to operate in Auto mode. If a GPS fix cannot be achieved, refer to troubleshooting (chapter 15).



5.3 RESET THE PITCH AND ROLL ANGLES

⚠ IMPORTANT During Initial Start, the pitch and roll angle indicators are reset. When launched, level the boat in calm waters at a standstill and perform a reset manually for the system's automatic control functions to work properly.

1. Press the MENU button.
2. Select Reset Pitch & Roll and press SELECT.

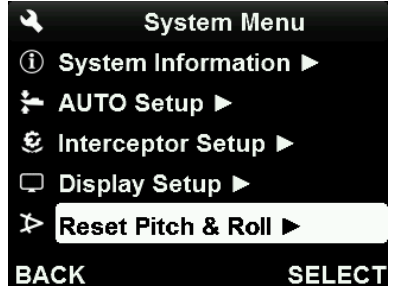

3. Select Reset Pitch and press RESET. Press YES in the pop-up window to confirm.
4. Select Reset Roll and press RESET. Press YES in the pop-up window to confirm.

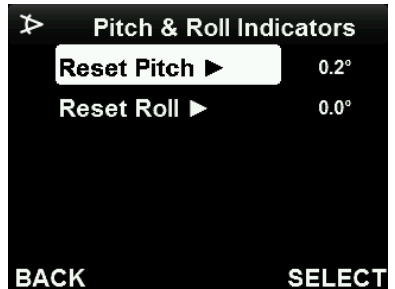

NOTE!

Both the pitch and roll angles should now read close to 0.0°. An angle reset can only be conducted at speeds below 5 knots.

6 MANUAL MODE

6.1 MANUAL PITCH AND ROLL

With the system in Manual mode, the boat's running attitude can be manually controlled using the control wheels. The Pitch wheel controls the trim or pitch angle, while the Roll wheel controls the list or roll angle.

Bow down

Turn the Pitch wheel forward



Correcting port list

Turn the Roll wheel clockwise

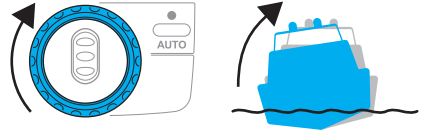

Bow up

Turn the Pitch wheel rearward

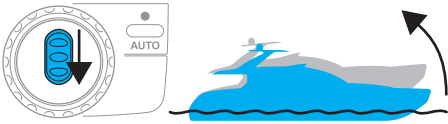

Correcting starboard list

Turn the Roll wheel counter-clockwise

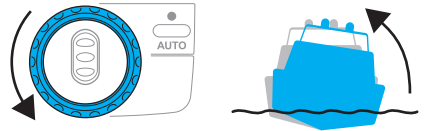

6.2 STEERING MODE

With Steering mode activated the Roll wheel acts as a steering wheel and controls the boat's heading or yaw angle.

⚠ IMPORTANT Steering mode should only be used to make sensible course corrections when running in relatively calm waters. Steering mode remains off/turns off if Auto mode (chapter 7) is activated.

1. To activate Steering mode, press and hold the Roll wheel (A) until STEER (B) appears on the display.
2. Turn the Roll wheel clockwise to steer to starboard (STBD).
3. Turn the Roll wheel counter-clockwise to steer to port (PORT).
4. To turn off Steering mode, press and hold the Roll wheel (A) until STEER (B) disappears from the display.

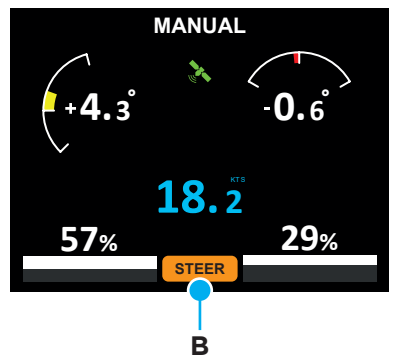
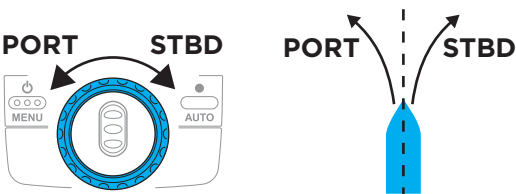
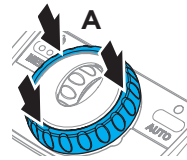

NOTE!

Steering mode is also available in Auto Pitch mode (chapter 8).

6.3 WAKE MODE

In wake mode, the system's wake-shaping feature allows easy control of the interceptor blades, positioning them at predetermined extensions to create the ideal wake shape on either side of the wave behind the boat.

⚠ IMPORTANT Wake mode remains off/turns off if Auto mode (chapter 7) is activated.

1. Press and turn the Roll wheel. The interceptor blades will be extended to predetermined extensions stored in memory.
2. Press and turn the Roll wheel clockwise to shape the wake at starboard side.
3. Press and turn the Roll wheel counter-clockwise to shape the wake at port side.
4. Turning Roll Wheel without pressing down allows fine-tuning of the interceptor extensions and the wake-shaping. The new extensions are automatically stored in memory and will be used at the next press and turn action.
5. Exit Wake mode by pressing and hold the Roll wheel for 3s or by changing to Auto mode.

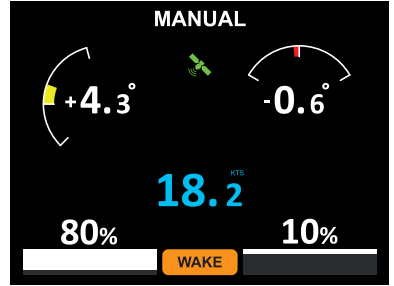

NOTE!

Wake mode is also available in Auto Pitch mode (chapter 8).

7 AUTO MODE

In Auto mode, the system automatically adjusts the running trim (Pro active pitch), eliminates uncomfortable and dangerous roll (Pro active roll), and maintains the ideal heel when turning (Pro balanced turn) to optimize wave resistance, performance and comfort at all speeds all the time.

Pro active pitch control refers to rapid automated adjustment of the vessel's pitch angle to optimize performance, fuel efficiency, stability, and comfort. Using the system's sensors, the active pitch controller continuously modifies the interceptors' extensions to dampen pitch motions and hold the boat at its optimum running trim angle.

Pro active roll control refers to rapid automated adjustment of the vessel's roll angle to optimize performance, stability, and comfort. Using the system's sensors, the active roll controller continuously modifies the interceptors' extensions to dampen roll motions and keep the boat level.

The pro balanced turn function is designed to optimize comfort on board by maintaining the ideal heeling angle throughout turns, thereby eliminating the centrifugal forces experienced by the passengers. The function includes advanced turning recognition using the system's built-in sensors, avoiding awkward integration with the steering system.

⚠ IMPORTANT The system's automatic control functions remain off/turn off when no GPS speed signal is available or in the event of other system failure(s). A flashing error message is then shown at the top of the main display and the satellite turns red.

7.1 ACTIVATE AUTO MODE

To activate Auto mode, press and hold the AUTO button until AUTO (A) appears on the display and the Pitch (B) and Roll (C) indicators turn green.

Current pitch angle (D).

Current roll angle (E).

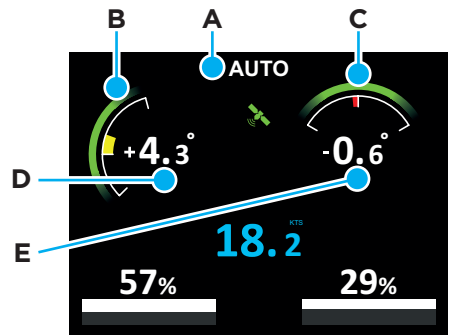

7.2 PRO ACTIVE PITCH CONTROL

With Auto mode activated, the pro active pitch control will automatically adjust the vessel's pitch angle to optimize performance, fuel efficiency, stability and comfort.

To achieve best performance the system relies on a pitch curve that characterizes the planing properties of the boat. When starting the system the first time (chapter 5), a default Auto Pitch Curve is calculated based on your boat data (length, beam, weight). The Curve tells the system how much the interceptors will be extended at each speed, thereby adjusting the boat's pitch angle as a function of speed.

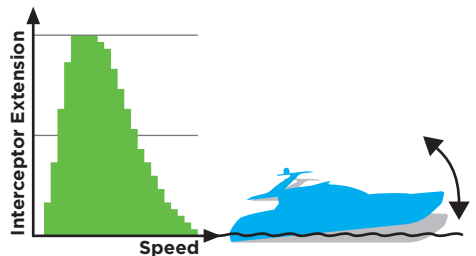

In addition, the system sets a Target Pitch Angle (chapter 7.2.4), that is the running trim angle which the Active pitch tries to hold.

7.2.1 PITCH OFFSET

The running trim can be altered (pitch offset) to adjust the boat's trim at certain loads, speeds, and/or sea conditions.

1. To trim the bow down, turn the Pitch wheel forward to increase pitch offset.
2. To trim the bow up, turn the Pitch wheel rearward to decrease pitch offset.

The applied offset is shown in green numbers (A).

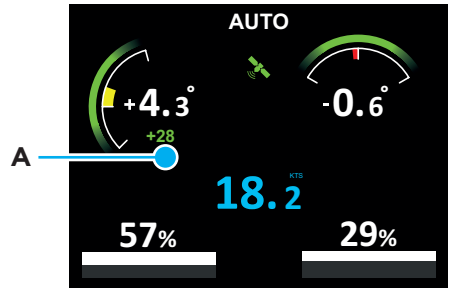

NOTE!

The pitch offset stays the same until it is altered again. To remove the offset adjust back to zero (no green numbers). The offset is also reset when exiting auto mode and at system restart.

⚠ IMPORTANT Avoid trimming down the bow excessively as this can result in bow steering and course instability.

7.2.2 SAVE PITCH OFFSET TO THE AUTO PITCH CURVE

If the adjusted pitch offset resulted in a better running trim, you can save it by pressing and holding the Roll wheel (B) until the pitch offset (A) disappears. The Target Pitch angle and Auto Pitch curve is adjusted accordingly. The Auto Pitch Curve is adjusted locally according to the boat's current speed.

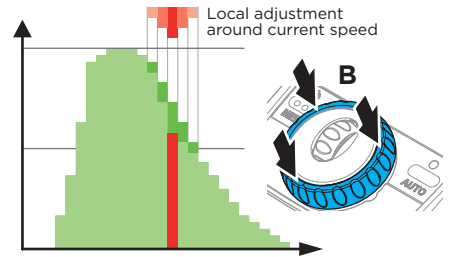

NOTE!

Saving a preferred trim setting in this manner, at a few different boat speeds, is a very quick way to build the optimum curve for your boat with its specific load. When optimizing the pitch curve this way it is advised to disable active pitch (chapter 7.2.4) and run the system in Auto Pitch mode (chapter 8). Details of the curve can be viewed and adjusted from the menu page (chapter 7.2.3).

7.2.3 EDIT THE AUTO PITCH CURVE

The Auto Pitch Curve tells the system how much the interceptors should be extended at each speed, thereby adjusting the boat's pitch angle as a function of speed. When starting the system the first time (chapter 5), a default curve is calculated based on your boat data (length, beam, weight). The Auto Pitch Curve can be viewed and fine-tuned from the menu page.

1. Press the MENU button.
2. Select AUTO Setup and press SELECT.
3. Select AUTO Pitch Setup and press SELECT.



- Select AUTO Pitch Curve and press SELECT.



- Press EDIT to enter edit mode.
- Turn the Roll wheel to move to the desired speed.
- A: Turn the Pitch wheel forward to increase interceptor extension and lower the bow (decrease pitch angle).
or
B: Turn the Pitch wheel rearward to decrease interceptor extension and raise the bow (increase pitch angle).
- Repeat steps 5-6 if more than one setting is to be adjusted.
- Press SAVE to update the curve.

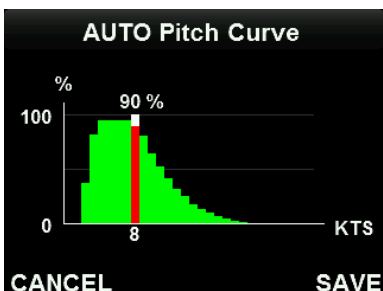
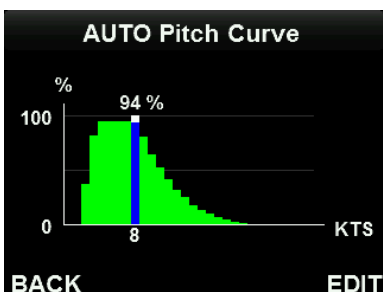

NOTE!

To reset the AUTO Pitch Curve to the original (default) setting, adjust the boat data entered to the system or perform a factory reset (chapter 13.1).

7.2.4 ACTIVE PITCH AND TARGET PITCH ANGLE

With Active pitch enabled, the Target Pitch Angle tells the system which running trim angle to try to hold, e.g. when the center of gravity shifts. Decrease the Target Pitch Angle to run with the bow lower or increase to raise the bow. The Target Pitch Angle is updated if the pitch curve is adjusted by saving an applied pitch offset. Active Pitch control can be disabled, letting the system rely on the pitch curve only to control the pitch in Auto mode.

To disable/enable Active Pitch and/or adjust the target angle:

- Press MENU button.
- Select AUTO Setup and press SELECT.
- Select AUTO Pitch Setup and press SELECT.
- Select Active Pitch and press EDIT to uncheck/check the box to disable/enable Active Pitch.
and/or
- Select Target Pitch Angle and press SELECT.
- Adjust the angle and press OK.

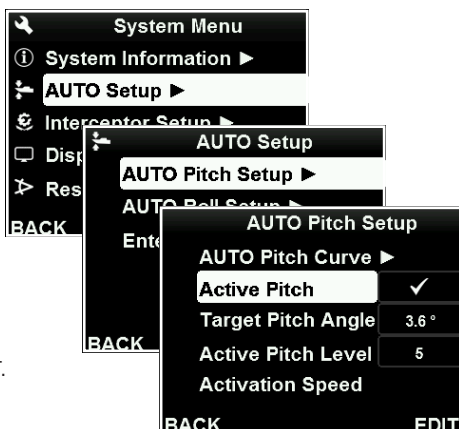

7.2.5 ACTIVE PITCH LEVEL

The Active Pitch sensitivity can be adjusted from level 1-10. Increase or decrease the Pitch Level to optimize the performance of the boat.

1. Press the MENU button.
2. Select AUTO Setup and press SELECT.
3. Select ACTIVE Pitch and press SELECT.
4. Change the Pitch Level and press SELECT.



NOTE!

Pitch Level 5 equals normal (default) sensitivity. Try different Levels until you are satisfied.

7.2.6 ACTIVE PITCH ACTIVATION SPEED

The Active Pitch Control is active above a speed that is calculated based on the entered boat data. The speed limit can be adjusted from the default value.

1. Press the MENU button.
2. Select AUTO Setup and press SELECT.
3. Select ACTIVE Pitch and press SELECT.
4. Select Lower Limit and press SELECT.
5. Adjust the speed and press OK.



7.3 PRO ACTIVE ROLL CONTROL

With Auto mode activated, the pro active roll control will automatically eliminate uncomfortable and dangerous boat roll. The system constantly works to keep the boat level or to make pro balanced (banked) turns. For boats that tend to heel too much inward in turns, the system will help the boat make sharper turns.

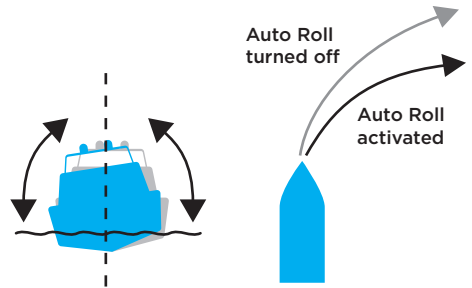

⚠ IMPORTANT Pro Active Roll Control is only active if boat speed is within the Auto Roll Activation speed range (chapter 7.3.3).

7.3.1 ROLL OFFSET

The boat's running list can be altered (roll offset) to temporarily adjust the list of the boat to better handle particular wave and/or wind conditions:

1. To offset the roll (list the boat) port, turn the Roll wheel counter-clockwise
2. To offset the roll (list the boat) starboard, turn the Roll wheel clockwise.

The applied offset is shown in green numbers (A).

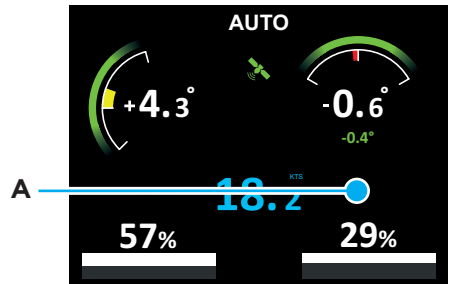

NOTE!

The roll offset stays the same until it is altered again. To remove the offset adjust back to zero (no green numbers). The offset is also reset when exiting auto mode and at system restart.

7.3.2 AUTO ROLL LEVEL

With Auto Roll Control activated, its sensitivity can be adjusted from level 1-10. Increase or decrease the Roll Level depending on sea and load conditions.

1. Short press the Roll wheel to open up the roll level indicator.
2. Turn the Roll wheel clockwise to increase the Roll Level.
Turn the Roll wheel counter-clockwise to decrease the Roll Level.
3. The Roll Level indicator times out after a few seconds and the new Roll Level is saved.

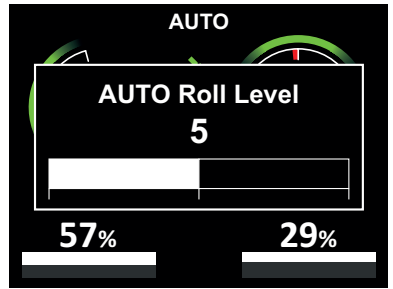

NOTE!

Roll Level 5 equals normal (default) sensitivity. Try different Levels until you are satisfied. The selected Roll Level is saved until you select a new level.

7.3.2 AUTO ROLL ACTIVATION SPEED

The Auto Roll Control is active within a speed range that is calculated based on the entered boat data. The lower and upper limits can be adjusted from their default values.

1. Press the MENU button.
2. Select AUTO Setup and press SELECT.
3. Select Auto Roll Setup and press SELECT.
4. Select Lower/Upper Limit and press SELECT.
5. Adjust the speed and press OK.

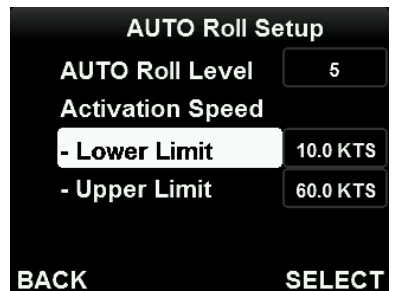

NOTE!

Once speed exceeds upper limit, AUTO roll remains inactive until speed drops below the upper limit by 6 knots while holding a steady heading.

8 AUTO PITCH MODE

In Auto Pitch mode, the system automatically adjusts the running trim (Pro active pitch), but the roll function (Pro active roll) is inactivated.

8.1 ACTIVATE AUTO PITCH MODE

When in Auto mode press the AUTO button to activate Auto Pitch mode. AUTO PITCH (A) appears on the display and the green arc on the Roll (B) indicator disappears.

The pitch can be adjusted the same way as in Auto mode.

Press the AUTO button again to return to Auto mode.

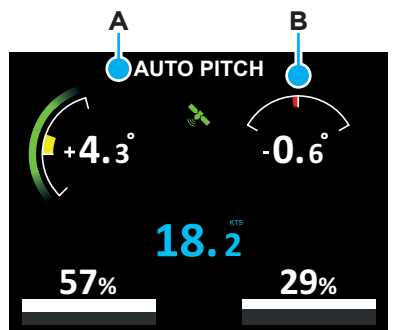

9 INTERCEPTOR SETUP

9.1 MANUAL CONTROL RATE

The relationship between the turning rate of the control wheels and the interceptors' actuation speed can be adjusted from low to high in manual control mode. A high control rate provides fast actuation for more aggressive manual piloting, whereas a low setting is the default and sufficiently fast for most helmsmen.

1. Press the MENU button.
2. Select Interceptor Setup and press SELECT.
3. Select Manual Ctrl Rate and press SELECT to adjust the rate.

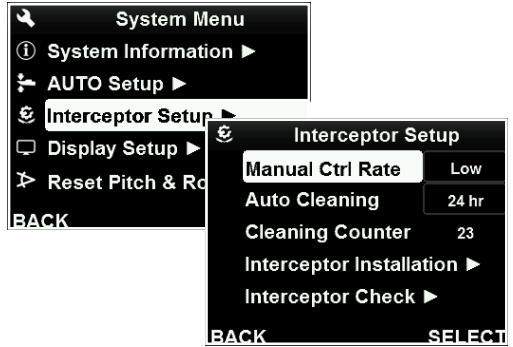

9.2 AUTO CLEANING

With AUTO cleaning enabled the system automatically carries out 3 consecutive cleaning cycles (blade moves in-out-in) with a periodicity selectable from 24 hours to 4 weeks. Moving the interceptor blade frequently in-and-out is an effective way to prevent fouling on the insides of the interceptors when boats stay in the water for long periods.

Refer to the Installation Guide's wiring diagram for information about connecting system power if Auto Cleaning is to be used.

1. Press the MENU button.
2. Select Interceptor Setup and press SELECT.
3. Select Auto Cleaning and press SELECT to adjust the desired cleaning cycle.

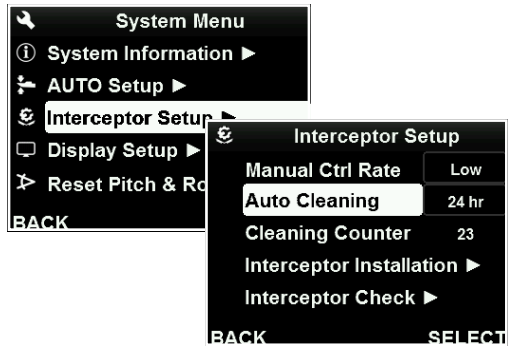

Reset the cleaning counter:

1. Press the MENU button.
2. Select Interceptor Setup and press SELECT.
3. Select Cleaning Counter and press RESET. Press YES in the pop-up window to confirm.

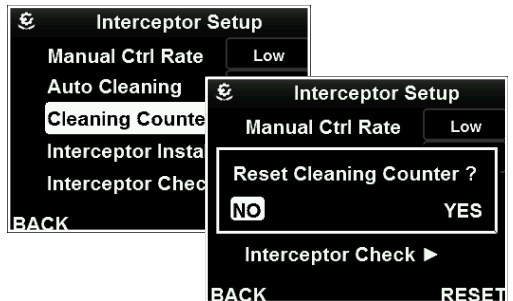

NOTE!

Disable Auto Cleaning or disconnect power to the system when the boat is hauled out of the water.

9.3 INTERCEPTOR INSTALLATION

Details about the current system installation including boat hull type, distribution unit(s) and interceptor configuration are managed and visualized from the Interceptor Installation menu page.

ENTER THE INTERCEPTOR INSTALLATION MAIN PAGE

1. Press the MENU button.
2. Select Interceptor Setup and press SELECT.
3. Select Interceptor Installation and press SELECT.
4. Make sure settings represents the actual system installation (chapter 9.3.1 - 9.3.3).

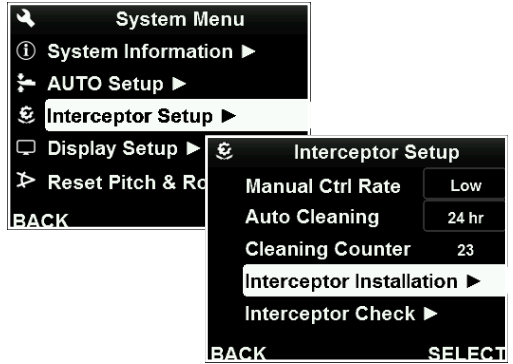

9.3.1 HULL TYPE

1. Select Hull Type and press SELECT to switch between monohull and catamaran settings.

NOTE! The Hull Type setting must represent the actual installation.

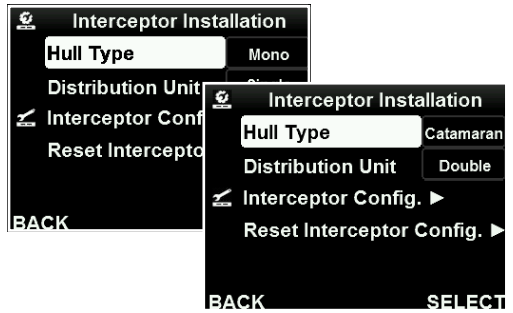

9.3.2 DISTRIBUTION UNIT(S)

1. Select Distribution Unit and press SELECT to specify the number of distribution units used in the installation (Single or Double).

NOTE! The Distribution Unit setting must represent the actual installation.

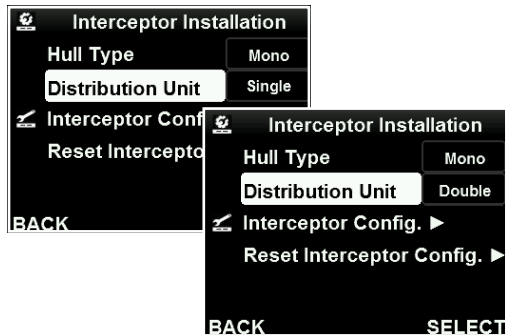

NOTE!

For systems with double distribution units, the starboard interceptors must be connected to DU-EX PRO.

9.3.3 INTERCEPTOR CONFIGURATION

Interceptor Configuration shows the system's current configuration. The connected interceptors are activated when saved to the system by pressing and holding down the Roll wheel (SAVE).

1. Select Interceptor Configuration and press SELECT to enter the graphical interface for the distribution unit and interceptor configuration.
2. If a new interceptor pair or a center-mounted interceptor has been added, press and hold the Roll wheel (A) to save the configuration. The interceptors change to white when saved.

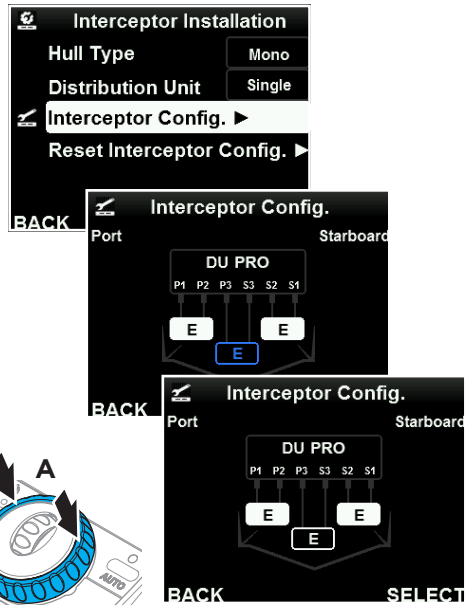
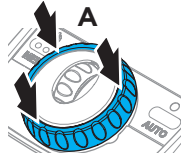

NOTE!

The SAVE option is only present when the connected interceptors differ from the previously saved configuration, where added and missing interceptors are showed in blue and orange, respectively. Unpaired interceptors (except center-mounted interceptors) cannot be saved to the system.

Interceptor functions

The system allows custom allocation of control forces by setting pitch, roll and yaw control as active or inactive for each pair of port and starboard interceptors. A pair's function may also be switched e.g. to mitigate roll-induced steering forces from another interceptor pair or pairs.

1. Select an interceptor pair or a center-mounted interceptor and press SELECT.
2. Set the interceptor function to activate/deactivate and press EDIT.

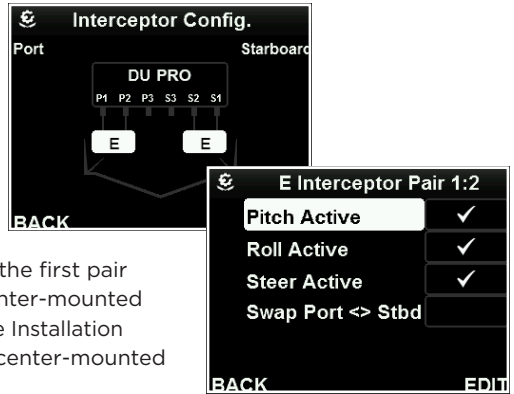

NOTE!

In systems with multiple interceptor pairs, the first pair will always be active in pitch and roll. A center-mounted interceptor only controls pitch. Refer to the Installation Guide for information about connecting a center-mounted interceptor to the distribution unit.

9.3.4 RESET INTERCEPTOR CONFIGURATION

Select Reset interceptor Configuration and press SELECT to reset the configuration saved to the system and start a new configuration.



9.4 INTERCEPTOR CHECK

Carry out an Interceptor Check to verify function immediately after installation and before launching the boat. Repeat this before every launch.

When launched, carry out an Interceptor Check at regular intervals to monitor the status of each interceptor.

NOTE!

Interceptor Check will not start if no interceptor configuration has been saved to the system (chapter 9.3.3).

The check repeats a 5 stroke sequence, where each interceptor blade is extended and retracted. Visually confirm that the interceptors move during the check to confirm that the interceptors are correctly connected to the distribution unit(s).

For easy torque level assessment, the numerical values are depicted in green-to-red bar graphs, where green is acceptable and red is too high.

1. Press the MENU button.
2. Select Interceptor Setup and press SELECT.
3. Select Interceptor Check and press SELECT.

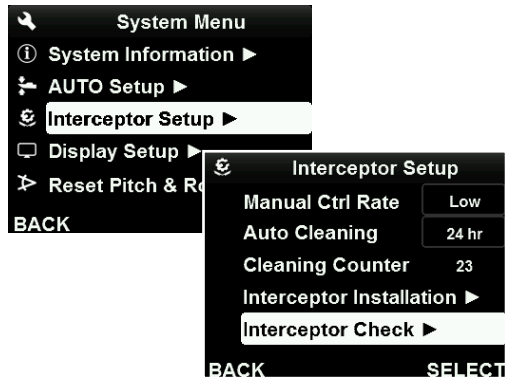

4. Press START to perform the test cycle.

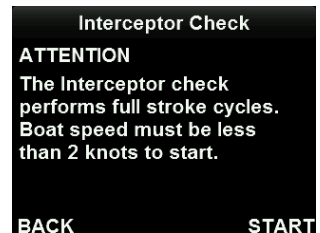

5. Turn the Roll or Pitch wheel to toggle different positioned interceptors, i.e. from Port Interceptor 1 to Starboard Interceptor 1.

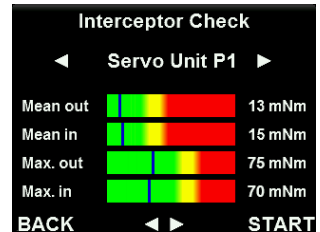

IMPORTANT All readings must be green!

Corrective actions are always necessary when excessive torque levels are observed. Verify the flatness of the transom, excess use of sealant behind the interceptor and/or excess antifouling between the blades and adjust if needed. Check for blade damage and marine growth at regular intervals.

Always use the controls to move the interceptor blades. Never try to force the interceptor blades by hand.

10 TURN ON THE SYSTEM

1. Press and hold the POWER button until the Zipwake logo appears on the display.
2. Read the ATTENTION text and press OK or wait (7 sec) for the main display.



NOTE!

When the boat's ignition switch is connected to the Key Sense input on the back of the control panel (chapter 3), the system is automatically turned on when the ignition switch (engine) is turned on.

11 TURN OFF THE SYSTEM

NOTE!

The system also automatically turns off after 12 hours of standstill (no GPS speed).

With AUTO cleaning enabled (chapter 9.2), the system will automatically wake up periodically and carry out 3 consecutive cleaning cycles when the system is turned off.

11.1 TURN OFF - SINGLE CONTROL PANEL

1. To turn off the system press and hold the POWER button.
2. A countdown appears on the display.
3. Keep the POWER button pressed until the countdown reaches 1 or the system will revert to the main display.
4. The system is turned off and the interceptors are automatically retracted. With AUTO cleaning enabled, the selected interval is displayed during the turn off sequence.

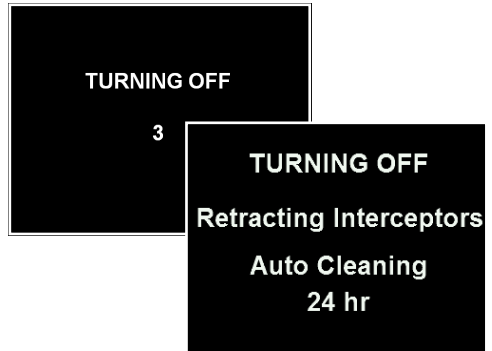

11.2 TURN OFF - MULTIPLE CONTROL PANELS

If more than one control panel is installed, choose to either turn off the system or only turn off the current display.

1. Press and hold the POWER button until the System Turn-Off menu appears.
2. A:
A: Select Turn Off Display and press SELECT to turn off the display. Press the POWER button to reactivate the display
or
B: Select Turn Off System and press SELECT to turn off the system. The system is turned off and the interceptors are automatically retracted.

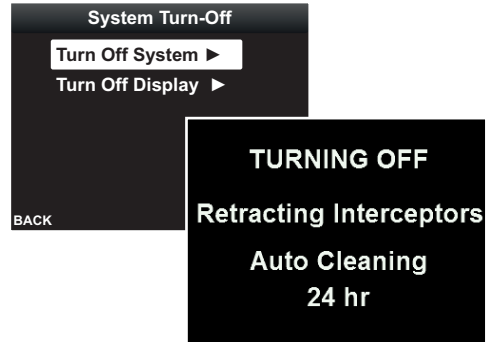

11.3 IGNITION SWITCH INSTALLATION

When the boat's ignition switch is connected to the Key Sense input on the back of the control panel (chapter 3), the system is automatically turned off when the ignition switch (engine) is turned off.

12 DISPLAY SETTINGS

1. Press the MENU button.
2. Select Display Setup and press SELECT.



3. Select Brightness and press SELECT to adjust the display brightness 1-100%. The menu choice is not available if Display mode is set to Auto.
4. Select Display mode and set it to Auto (default), Day or Night.

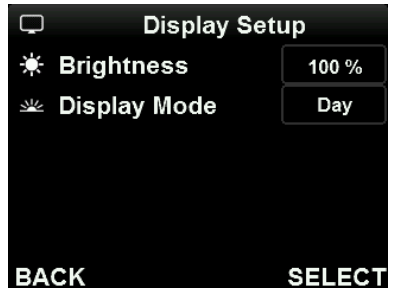

NOTE!

With the Display mode set to Auto, the display automatically adjusts the brightness depending on the ambient light and switches between Day mode (normal screen) and Night mode (red screen).

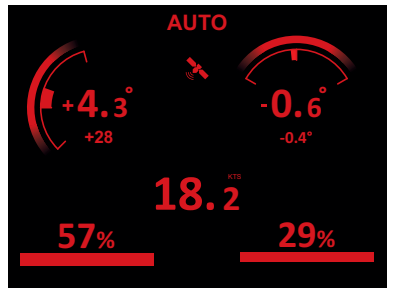

13 ADVANCED SETUP

13.1 FACTORY RESET

To reset the settings and the Auto Pitch Curve to default, perform a Factory Reset.

⚠ IMPORTANT A Factory Reset resets all values and settings in the system. You can backup (chapter 13.2) and reinstall either the settings or the Auto Pitch Curve after a Factory Reset has been performed.

1. Press the MENU button.
2. Select Advanced Setup and press SELECT.



3. Select Factory Reset and press SELECT.
4. Press OK in the pop-up window to confirm.
5. The system will now reset all the settings and turn off.
6. Start the system and perform a new setup (chapter 5).

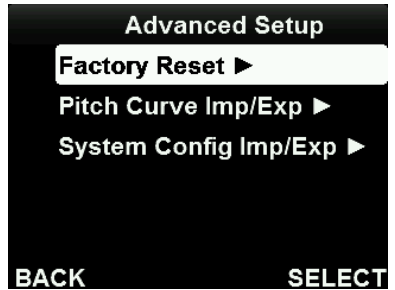

13.2 IMPORT/EXPORT DATA

Backup the Auto Pitch Curve and settings to a USB memory stick for re-installation and/or to transfer settings between control panels/boats.

⚠ IMPORTANT A USB memory stick with FAT32 formatting must be connected to the system when importing/exporting data.

1. Press the MENU button.
2. Select Advanced Setup and press SELECT.



- Remove the USB (A) connector cover on the back of the control panel and connect a USB memory stick to the DEVICE connector before export/import.



- Select Pitch Curve Imp/Exp or System Config Imp/Exp, press SELECT and follow the steps provided.
- Remember to remove the USB memory stick and put the connector cover back in place when done.



14 SYSTEM INTEGRATION

14.1 ZIPWAKE INTEGRATOR MODULE

The optional integrator module supports connections to a wide range of MFD brands/models via an ethernet interface. Its wireless interface enables connection to smartphones and tablets by means of Zipwake's app for wireless views, control, configuration and software updates.

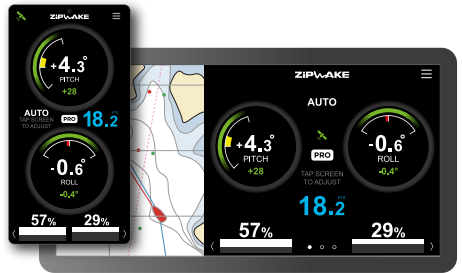

14.2 NMEA 2000

When connected to an NMEA 2000 network, the Zipwake system can receive GPS data from compatible devices, and transmit data to allow monitoring on e.g. MFDs or plotters.

Refer to the NMEA 2000 documentation at zipwake.com for more information (transmitted and received signals etc.).

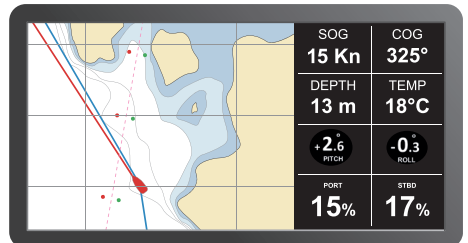

NOTE!

If multiple control panels are installed, only one of them should be connected to the NMEA 2000 network.

15 TROUBLESHOOTING

15.1 SYSTEM ERROR INFORMATION

A red satellite (A) indicates no GPS connection. A flashing error symbol (B) indicates system errors that need attention. An interceptor error symbol (C) indicates an error with one or more interceptors. For a complete list of error descriptions and corrective actions see chapter 15.3.

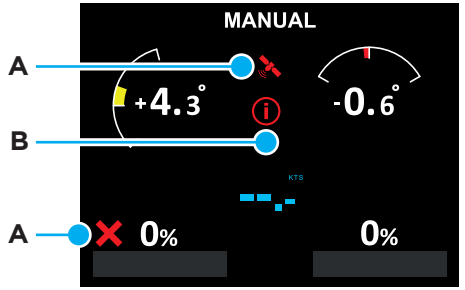

1. Press the MENU button.
2. Select System Information and press SELECT.
3. Select a row with an error code and press SELECT.
4. Select the error code and press SELECT.
5. Read the error message(s) and go to chapter 15.3 for corrective actions.

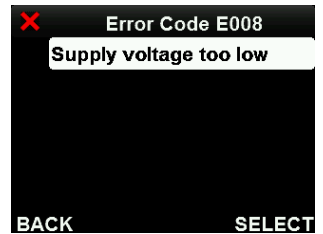
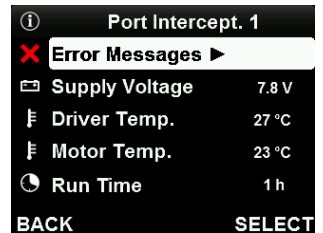
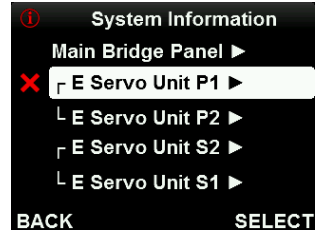

15.2 BATTERY WARNING

Check the battery condition if the battery error symbol (A) is shown when the system is turned on.

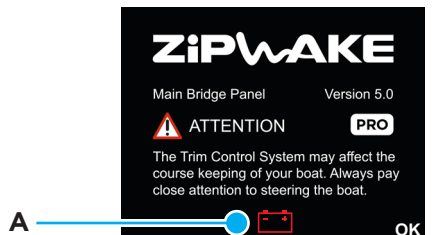

15.3 ERROR CORRECTIVE ACTIONS

Check the corrective actions below to resolve problems. Visit www.zipwake.com for the latest product information, software upgrades and error corrective actions. If the problem remains, contact your retailer for support and/or replacement units.

Control Panel Error Messages

Supply voltage too low

- Check battery supply voltage (>12V).
- Check the power cable connection to the battery.

Supply voltage too high

- Check the distribution unit(s) power cable.
- Check battery supply voltage (12-32V).

Button/wheel failure

- Check if any buttons or wheels are stuck.
- Use fresh water to spray and remove any dirt on the control panel front.

Acc/gyro error

- Turn off the system for 10 minutes, then restart.

Panel temperature too high

- Check if the panel is mounted close to any heat source.
- Try mounting the panel in another (cooler) location.

Program error

- Restart the system.
- Visit www.zipwake.com for upgrades resolving the issue.

Interceptor config changed

- Go to Interceptor Configuration menu page to check which interceptor(s) differ from what is saved to the system.
- Save the correct interceptor configuration if not already accurately saved to the system.
- Check the servo cable(s) for damage.
- Clean and reattach the connector(s) to the distribution unit(s)

Invalid Interceptor config

- Make sure interceptors are connected in pairs to the distribution unit(s), starting from connectors P1/S1. Refer to the Installation Guide for information about which connector(s) to connect a center-mounted interceptor.
- Check the servo cables for damage.
- Clean and reattach the connectors to the distribution unit(s).

Communication error

- Check the system cables for damage.
- Clean and reattach connectors to the distribution unit(s) and control panels.

No GPS signal

- Check GPS source and GPS status on the Select GPS Source menu page (normally set to Auto).
- If an external GPS or NMEA 2000 GPS is installed, check the cables for damage.
- Check that the NMEA 2000 GPS source is turned on.
- Clean and reattach the control panel connectors.

Interceptor/Servo Unit Error Messages

Supply voltage too low

- Check battery supply voltage (>12V).
- Check the power cable connection to the battery.
- Check the distribution unit(s) power cable.

Supply voltage too high

- Check battery supply voltage (12-32V).

Interceptor stroke too long

- Restart the system.
- Remove the interceptor front and check that the blades are moving correctly. Remove any growth, dirt or paint.
- Reinstall the front, run the interceptor and check that the blades are moving correctly.

Electronics failure

- Restart the system.
- Visit www.zipwake.com for upgrades resolving the issue.

Overload, interceptor stuck

- Check for excessive growth, dirt or paint on the interceptor and between the blades.
- Remove the interceptor front and check that the blades are moving correctly.
- Reinstall the front, run the interceptor and check that the blades are moving correctly.

Motor drive temperature high

- Turn off the system for 10 minutes, then restart.

Motor temperature high

- Turn off the system for 10 minutes, then restart.

Motor HALL sensor failure

- Turn off the system for 10 minutes, then restart.

Motor drive failure

- Turn off the system for 10 minutes, then restart.

Outside full stroke

- Restart the system (repeat if needed).
- Remove the interceptor front and check that the blades are moving correctly. Remove excessive growth, dirt or paint.
- Remove the servo unit from the back plate and make sure the nut on the screw shaft pulls in towards the center of the servo at start-up.

Start-up error

- Restart the system.
- Check battery supply voltage (12-32V).
- Check that the interceptor blades move correctly.

15.4 OTHER ERRORS

The system's automatic control functions remain off/turn off or turn on/off intermittently (can happen if there is a system error or if there is no GPS speed signal).

- Check flashing error message when attempting to turn on Auto mode.
- Check System Information Menu and error messages above to resolve the problem.

Auto mode turns on/off intermittently

(can happen if the GPS has a weak signal or poor satellite coverage).

- Check GPS status in the Select GPS Source Menu. Set GPS Source to Auto.
- Connect an NMEA 2000 GPS source if available. Refer to the Installation Guide.
- Install Zipwake external GPS if the control panel is mounted under a shielding top (roof). Refer to the Installation Guide.

The boat lists to port when the roll wheel is turned to starboard (clockwise) at speed

- Check how the interceptors are connected to the distribution unit(s). Refer to the Installation Guide for correct connection.

16 MAINTENANCE

 **WARNING** Watch out for sharp edges when close to the interceptors.

 **IMPORTANT** Always use the controls to move the interceptor blades. Never try to force the interceptor blades by hand.

16.1 LAUNCH

Paint the interceptors with anti-fouling paint before launching your boat. If possible use spray paint (recommended). When the paint is dry, remove excess paint between the interceptor blades. Before launching the boat, move the interceptor blades full strokes using the controls to ensure that they move freely and correctly. Refer to the Installation Guide for more information.

Verify acceptable servo torque levels by running an Interceptor Check (chapter 9.4).

16.2 HAUL-OUT

 **IMPORTANT** When your boat is hauled out of the water, do not place any supporting blocks pushing against the interceptors or blocking the interceptor blades.

After your boat has been hauled out of the water, use a pressure washer to remove any growth or dirt on the interceptors. Fully extend the interceptor blades using the controls and pressure wash them. Check the blades for damage. When washing is completed, retract the interceptor blades by turning off the system. Check that the cable covers are in place and not damaged. When the boat is hauled out after being in the water for an extended time, we recommend temporarily removing the interceptor fronts and pressure washing the inside of the interceptors thoroughly.

 **IMPORTANT** When cleaning the control panel:

- Only use fresh water and wipe with a soft towel when cleaning the front of the control panel(s).
- Do not wipe the display/screen with a dry cloth as this could scratch the screen coating.
- Do not use abrasives, or acid-/ammonia-based products.
- Do not use a pressure washer.

17 SYSTEM UPGRADE

The Dynamic Trim Control System software can be upgraded. Visit www.zipwake.com to check for new software releases.

⚠ IMPORTANT The software upgrade file must be saved to the root of a USB memory stick with FAT32 formatting when upgrading the system.

1. Download a software upgrade file from www.zipwake.com.
2. Copy the software upgrade file to the root of the USB memory stick.
3. Remove the USB (A) connector cover on the back of the control panel and connect the USB memory stick to the DEVICE connector.
4. Restart the system and follow the instructions on the display.
5. Remember to remove the USB memory stick and put the connector cover back in place when done.



NOTE!

Your System Configuration (user settings) and Auto Pitch Curve will not be erased when you upgrade to another software version. You can also downgrade to a previous software release.

Visit zipwake.com for additional information such as:

- Operator's Manuals and Installation Guides in different languages
- Product specifications, including a list of accessories and spare parts
- Application examples and Interceptor mounting options
- Drawings and 3D models of system components
- Software upgrades for your Dynamic Trim Control System
- NMEA 2000 documentation

ZIPWAKE

CHOOSE COMFORT. ENJOY PERFORMANCE.