

For Low Pressure

# Hi Cupla

Universal purpose couplings for air lines

Working pressure	Working pressure	Valve structure	Applicable fluids (Steel applies to air only)
1.5 MPa (15 kgf/cm <sup>2</sup> )	1.0 MPa (10 kgf/cm <sup>2</sup> )	One-way shut-off	Air Water

From factory air line to pneumatic tool connection, available in various body materials, sizes and end configurations. Excellent durability.

- An excellent general purpose coupling for connecting factory air supply to pneumatic tools.
- Steel coupling is suitable for air. Brass or stainless steel is suitable for water. Note that fluid will come out from the plug when disconnected.
- Critical structural parts of steel models are heat-treated for increased strength giving greater durability and resistance to wear.
- Available in various body materials, sizes and end configurations applicable to a wide range of applications.

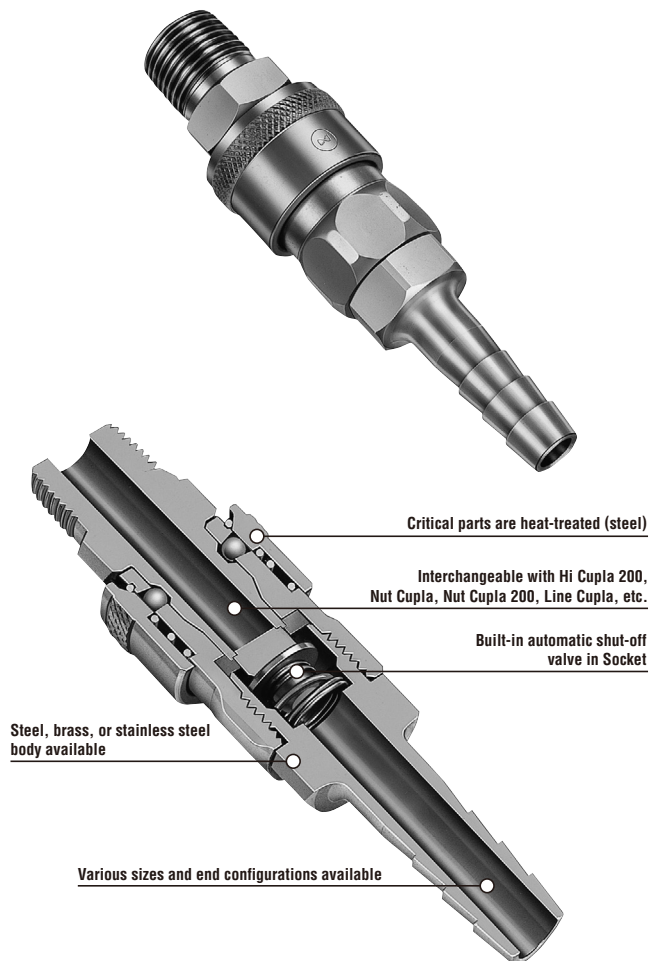

Specifications				
Body material		Steel (Plated)	Brass	Stainless steel
Size	Thread	1/8" to 1"		
	Hose barb	1/4" to 1" hose		
Working pressure	MPa	1.5	1.0	1.5
	kgf/cm <sup>2</sup>	15	10	15
	bar	15	10	15
	PSI	218	145	218
Seal material	Seal material	Mark	Working temperature range	Remarks
Working temperature range	Nitrile rubber	NBR (SG)	-20°C to +80°C	Standard material
	Fluoro rubber	FKM (X-100)	-20°C to +180°C	

Max. Tightening Torque		Nm (kgf·cm)					
Size (Thread)		1/8"	1/4"	3/8"	1/2"	3/4"	1"
Torque	Steel	7 (71)	14 (143)	22 (224)	60 (612)	100 (1020)	120 (1224)
	Brass	5 (51)	9 (92)	11 (112)	30 (306)	50 (510)	65 (663)
	Stainless steel	—	14 (143)	22 (224)	60 (612)	100 (1020)	120 (1224)

**Flow Direction**

Fluid must run from socket to plug.

- Interchangeability**
1. Sockets and plugs for Models 10, 17, 20, 30, and 40 can be connected with each other regardless of end configurations.
  2. Sockets and plugs for Models 400, 600, and 800 can be connected with each other regardless of end configurations. 1 and 2 can not be connected across each group.
  3. Interchangeable with all other Hi Cupla Series products. Please see the page for "Hi Cupla Series Interchangeability."

		Min. Cross-Sectional Area (mm <sup>2</sup> )										
<b>10, 17, 20, 30, 40 type</b>												
Socket	Plug	17PH	20PH	30PH	40PH	10PM	20PM	30PM	40PM	20PF	30PF	40PF
10SM		16	20	20	20	13	20	20	20	20	20	20
17SH		16	16	16	16	13	16	16	16	16	16	16
20SH		16	20	20	20	13	20	20	20	20	20	20
20SM, SF		16	20	33	33	13	33	33	33	33	33	33
30SH		16	20	33	33	13	33	33	33	33	33	33
30SM, SF		16	20	33	33	13	33	33	33	33	33	33
40SH		16	20	33	33	13	33	33	33	33	33	33
40SM, SF		16	20	33	33	13	33	33	33	33	33	33
<b>400, 600, 800 type</b>												
Socket	Plug	400PH	600PH	800PH	400PM	600PM	800PM	400PF	600PF	800PF		
400SH		64	64	64	64	64	64	64	64	64	64	64
400SM, SF		64	94	94	94	94	94	94	94	94	94	94
600SH		64	94	94	94	94	94	94	94	94	94	94
600SM, SF		64	94	94	94	94	94	94	94	94	94	94
800SH		64	94	94	94	94	94	94	94	94	94	94
800SM, SF		64	94	94	94	94	94	94	94	94	94	94

**Suitability for Vacuum**  
Not suitable for vacuum application in either connected or disconnected condition.

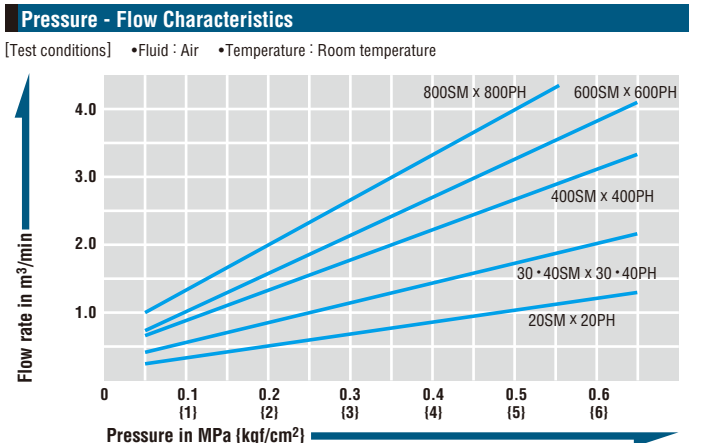

Models and Dimensions

**Plug PH type (Hose barb)**

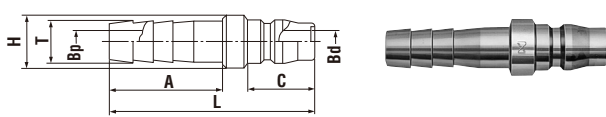

Model	Application (Hose)	Body material • Mass (g)			Dimensions (mm)						
		Steel	Brass	Stainless steel	L	øH	A	C	øT	øBp	øBd
17PH	1/4"	24	-	-	54	16	27	20	7.2	4.5	7.5
20PH	1/4"	28	31	27	57	16	30	20	9	5	7.5
30PH	3/8"	32	34	33	61	16	34	20	11.3	7.5	7.5
40PH	1/2"	59	64	60	63	20	36	20	15	9	7.5
400PH	1/2"	65	71	66	66	22	36	23	15	9	13
600PH	3/4"	123	130	124	77	30	45	23	21	13	13
800PH	1"	151	161	151	85	34	54	23	27	20	13

**Socket SH type (Hose barb)**

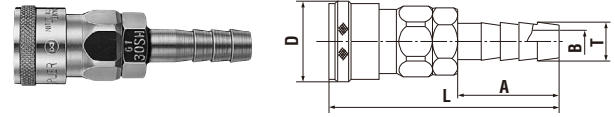

Model	Application (Hose)	Body material • Mass (g)			Dimensions (mm)				
		Steel	Brass	Stainless steel	L	øD	A	øT	øB
17SH	1/4"	99	-	-	(69.5)	(26.5)	27	7.2	4.5
20SH	1/4"	99	105	97	(72.5)	(26.5) <sup>+1</sup>	30	9	5
30SH	3/8"	102	107	100	(76.5)	(26.5) <sup>+1</sup>	34	11.3	7.5
40SH	1/2"	115	122	113	(78.5)	(26.5) <sup>+1</sup>	36	15	9
400SH	1/2"	220	235	230	(83)	35	36	15	9
600SH	3/4"	243	262	242	(92)	35	45	21	14
800SH	1"	327	350	325	(102)	35	55	27	16

**Plug PM type (Male thread)**

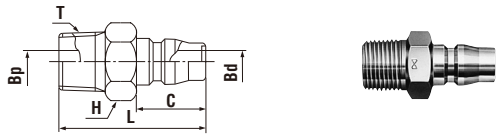

Model	Application	Body material • Mass (g)			Dimensions (mm)					
		Steel	Brass	Stainless steel	L	H(WAF)	C	T	øBp	øBd
10PM	Rc 1/8	22	24	-	37	Hex.14	20	R 1/8	4	7.5
20PM	Rc 1/4	25	27	26	41	Hex.14	20	R 1/4	7.5	7.5
30PM	Rc 3/8	40	43	41	42	Hex.19 <sup>-3</sup>	20	R 3/8	7.5	7.5
40PM	Rc 1/2	60	65	60	46	Hex.22	20	R 1/2	12	7.5
400PM	Rc 1/2	70	73	69	50	Hex.22	23	R 1/2	13	13
600PM	Rc 3/4	113	121	114	55	Hex.32	23	R 3/4	19	13
800PM	Rc 1	182	196	183	63	Hex.35	23	R 1	22	13

**Socket SM type (Male thread)**

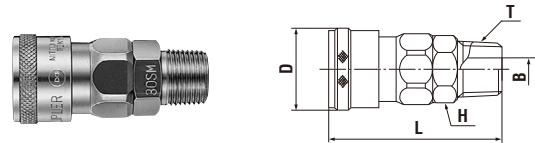

Model	Application	Body material • Mass (g)			Dimensions (mm)				
		Steel	Brass	Stainless steel	L	øD	H(WAF)	T	øB
10SM	Rc 1/8	97	-	-	(52.5)	(26.5)	Hex.19	R 1/8	5
20SM	Rc 1/4	97	103	96	(55.5)	(26.5) <sup>+1</sup>	Hex.19	R 1/4	7
30SM	Rc 3/8	104	108	100	(56.5)	(26.5) <sup>+1</sup>	Hex.19	R 3/8	8 <sup>+4</sup>
40SM	Rc 1/2	127	135	126	(59.5)	(26.5) <sup>+1</sup>	Hex.23 <sup>+2</sup>	R 1/2	9
400SM	Rc 1/2	210	224	212	(63)	35	Hex.29	R 1/2	13
600SM	Rc 3/4	242	259	243	(67)	35	Hex.32	R 3/4	16
800SM	Rc 1	329	353	328	(72)	35	Hex.36	R 1	16

**Plug PF type (Female thread)**



Model	Application	Body material • Mass (g)			Dimensions (mm)				
		Steel	Brass	Stainless steel	L	H(WAF)	C	T	øB
20PF	R 1/4	28	31	29	36	Hex.17	20	Rc 1/4	7.5
30PF	R 3/8	35	41	38	37	Hex.21	20	Rc 3/8	7.5
40PF	R 1/2	69	76	70	38	Hex.29	20	Rc 1/2	7.5
400PF	R 1/2	82	86	81	41	Hex.29	23	Rc 1/2	13
600PF	R 3/4	115	124	115	45	Hex.35	23	Rc 3/4	13
800PF	R 1	189	207	190	54	Hex.41	23	Rc 1	13

**Socket SF type (Female thread)**

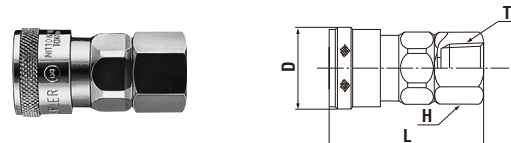

Model	Application	Body material • Mass (g)			Dimensions (mm)			
		Steel	Brass	Stainless steel	L	øD	H(WAF)	T
20SF	R 1/4	97	101	94	(49.5)	(26.5) <sup>+1</sup>	Hex.19	Rc 1/4
30SF	R 3/8	98	103	95	(50.5)	(26.5) <sup>+1</sup>	Hex.21	Rc 3/8
40SF	R 1/2	136	146	136	(52.5)	(26.5) <sup>+1</sup>	Hex.29	Rc 1/2
400SF	R 1/2	216	233	215	(57)	35	Hex.29	Rc 1/2
600SF	R 3/4	259	277	257	(61)	35	Hex.35	Rc 3/4
800SF	R 1	327	361	327	(68)	35	Hex.41	Rc 1

**Plug PFF type (Parallel female thread)**

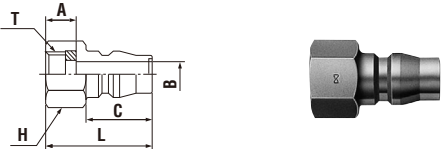

Model	Application	Body material • Mass (g)			Dimensions (mm)					
		Steel	Brass	Stainless steel	L	H(WAF)	A	C	T	øB
20PFF	G 1/4	23	-	-	32	Hex.17	9	20	G 1/4	7.5

• Above pictures are plugs and sockets of steel 20, 30 and 40 models.

\*1 : D = 25.4 for brass and stainless steel models.

\*2 : H = Hex. 22 for brass and stainless steel models.

\*3 : H = Hex. 17 for brass and stainless steel models.

\*4 : B = 9 for brass and stainless steel models.

Application Example

